



NONRESIDENT TRAINING COURSE



April 1994

Master-at-Arms

NAVEDTRA 14137

NOTICE

Pages 7-14, 7-15, 7-16, 7-17, 7-22, 7-23, 7-24, 7-28, 7-30, 7-31, 7-33, 7-34, 7-35, 7-36, and 7-43 must be printed on a **COLOR** printer.

Although the words “he,” “him,” and “his” are used sparingly in this course to enhance communication, they are not intended to be gender driven or to affront or discriminate against anyone.

PREFACE

By enrolling in this self-study course, you have demonstrated a desire to improve yourself and the Navy. Remember, however, this self-study course is only one part of the total Navy training program. Practical experience, schools, selected reading, and your desire to succeed are also necessary to successfully round out a fully meaningful training program.

THE COURSE: This self-study course is organized into subject matter areas, each containing learning objectives to help you determine what you should learn along with text and illustrations to help you understand the information. The subject matter reflects day-to-day requirements and experiences of personnel in the rating or skill area. It also reflects guidance provided by Enlisted Community Managers (ECMs) and other senior personnel, technical references, instructions, etc., and either the occupational or naval standards, which are listed in the *Manual of Navy Enlisted Manpower Personnel Classifications and Occupational Standards*, NAVPERS 18068.

THE QUESTIONS: The questions that appear in this course are designed to help you understand the material in the text.

VALUE: In completing this course, you will improve your military and professional knowledge. Importantly, it can also help you study for the Navy-wide advancement in rate examination. If you are studying and discover a reference in the text to another publication for further information, look it up.

*1994 Edition Prepared by
MACS(SW) Harry B. Brist*

Published by
NAVAL EDUCATION AND TRAINING
PROFESSIONAL DEVELOPMENT
AND TECHNOLOGY CENTER

**NAVSUP Logistics Tracking Number
0504-LP-026-7930**

Sailor's Creed

“I am a United States Sailor.

I will support and defend the Constitution of the United States of America and I will obey the orders of those appointed over me.

I represent the fighting spirit of the Navy and those who have gone before me to defend freedom and democracy around the world.

I proudly serve my country's Navy combat team with honor, courage and commitment.

I am committed to excellence and the fair treatment of all.”

CONTENTS

CHAPTER	Page
1. Rules and Regulations	1-1
2. Legal Aspects of Military Law2-1
3. Search and Seizure	3-1
4. Military Law of Evidence	4-1
5. Courts-Martial Procedures	5-1
6. Nonjudicial Punishment	6-1
7. Controlled Substances7-1
8. Small Arms	8-1
9. Crowd Control9-1
10. Physical Security	10-1
11. Military Working Dogs.	11-1
12. Patrol Procedures12-1
13. Military Customs Inspections13-1
14. Shipboard Duties14-1
15. Investigations	15-1
16. Forensics16-1
17. Evidence Custody	17-1
18. Administration18-1
APPENDIX	
I. Glossary of Terms in Law	AI-1
II. Methods of Transmittal for Items of Evidence	AII-1
III. Punitive Articles of the UCMJ	AIII-1
IV. References Used to Develop the TRAMAN.	AIV-1
INDEX	INDEX-1

INSTRUCTIONS FOR TAKING THE COURSE

ASSIGNMENTS

The text pages that you are to study are listed at the beginning of each assignment. Study these pages carefully before attempting to answer the questions. Pay close attention to tables and illustrations and read the learning objectives. The learning objectives state what you should be able to do after studying the material. Answering the questions correctly helps you accomplish the objectives.

SELECTING YOUR ANSWERS

Read each question carefully, then select the BEST answer. You may refer freely to the text. The answers must be the result of your own work and decisions. You are prohibited from referring to or copying the answers of others and from giving answers to anyone else taking the course.

SUBMITTING YOUR ASSIGNMENTS

To have your assignments graded, you must be enrolled in the course with the Nonresident Training Course Administration Branch at the Naval Education and Training Professional Development and Technology Center (NETPDTC). Following enrollment, there are two ways of having your assignments graded: (1) use the Internet to submit your assignments as you complete them, or (2) send all the assignments at one time by mail to NETPDTC.

Grading on the Internet: Advantages to Internet grading are:

- you may submit your answers as soon as you complete an assignment, and
- you get your results faster; usually by the next working day (approximately 24 hours).

In addition to receiving grade results for each assignment, you will receive course completion confirmation once you have completed all the

assignments. To submit your assignment answers via the Internet, go to:

<http://courses.cnet.navy.mil>

Grading by Mail: When you submit answer sheets by mail, send all of your assignments at one time. Do NOT submit individual answer sheets for grading. Mail all of your assignments in an envelope, which you either provide yourself or obtain from your nearest Educational Services Officer (ESO). Submit answer sheets to:

COMMANDING OFFICER
NETPDTC N331
6490 SAUFLEY FIELD ROAD
PENSACOLA FL 32559-5000

Answer Sheets: All courses include one “scannable” answer sheet for each assignment. These answer sheets are preprinted with your SSN, name, assignment number, and course number. Explanations for completing the answer sheets are on the answer sheet.

Do not use answer sheet reproductions: Use only the original answer sheets that we provide—reproductions will not work with our scanning equipment and cannot be processed.

Follow the instructions for marking your answers on the answer sheet. Be sure that blocks 1, 2, and 3 are filled in correctly. This information is necessary for your course to be properly processed and for you to receive credit for your work.

COMPLETION TIME

Courses must be completed within 12 months from the date of enrollment. This includes time required to resubmit failed assignments.

PASS/FAIL ASSIGNMENT PROCEDURES

If your overall course score is 3.2 or higher, you will pass the course and will not be required to resubmit assignments. Once your assignments have been graded you will receive course completion confirmation.

If you receive less than a 3.2 on any assignment and your overall course score is below 3.2, you will be given the opportunity to resubmit failed assignments. **You may resubmit failed assignments only once.** Internet students will receive notification when they have failed an assignment--they may then resubmit failed assignments on the web site. Internet students may view and print results for failed assignments from the web site. Students who submit by mail will receive a failing result letter and a new answer sheet for resubmission of each failed assignment.

COMPLETION CONFIRMATION

After successfully completing this course, you will receive a letter of completion.

ERRATA

Errata are used to correct minor errors or delete obsolete information in a course. Errata may also be used to provide instructions to the student. If a course has an errata, it will be included as the first page(s) after the front cover. Errata for all courses can be accessed and viewed/downloaded at:

<http://www.advancement.cnet.navy.mil>

STUDENT FEEDBACK QUESTIONS

We value your suggestions, questions, and criticisms on our courses. If you would like to communicate with us regarding this course, we encourage you, if possible, to use e-mail. If you write or fax, please use a copy of the Student Comment form that follows this page.

For subject matter questions:

E-mail: n313.products@cnet.navy.mil
Phone: Comm: (850) 452-1001, Ext. 2167
DSN: 922-1001, Ext. 2167
FAX: (850) 452-1370
(Do not fax answer sheets.)
Address: COMMANDING OFFICER
NETPDTC (CODE N313)
6490 SAUFLEY FIELD ROAD
PENSACOLA FL 32509-5237

For enrollment, shipping, grading, or completion letter questions

E-mail: fleetservices@cnet.navy.mil
Phone: Toll Free: 877-264-8583
Comm: (850) 452-1511/1181/1859
DSN: 922-1511/1181/1859
FAX: (850) 452-1370
(Do not fax answer sheets.)
Address: COMMANDING OFFICER
NETPDTC (CODE N331)
6490 SAUFLEY FIELD ROAD
PENSACOLA FL 32559-5000

NAVAL RESERVE RETIREMENT CREDIT

If you are a member of the Naval Reserve, you will receive retirement points if you are authorized to receive them under current directives governing retirement of Naval Reserve personnel. For Naval Reserve retirement, this course is evaluated at 29 points. This points will be credited as follows: 12 points for the satisfactory completion of assignments 1 through 8, 12 points for the satisfactory completion of assignments 9 through 16, 5 points for the satisfactory completion of assignments 17 through 19. (Refer to *Administrative Procedures for Naval Reservists on Inactive Duty*, BUPERSINST 1001.39, for more information about retirement points.)

COURSE OBJECTIVES

The objective of this course is to provide Masters-at-Arms with occupational information in the following areas: rules and regulations, legal aspects of military law, search and seizure,

military law of evidence, courts-martial procedures, nonjudicial punishment, controlled substances, small arms, crowd control, physical security, military working dogs, patrol procedures, military customs inspections, shipboard duties, investigations, forensics, evidence custody, and administration.

Student Comments

Course Title: Master-at-Arms

NAVEDTRA: 14137 **Date:** _____

We need some information about you:

Rate/Rank and Name: _____ SSN: _____ Command/Unit _____

Street Address: _____ City: _____ State/FPO: _____ Zip _____

Your comments, suggestions, etc.:

<p>Privacy Act Statement: Under authority of Title 5, USC 301, information regarding your military status is requested in processing your comments and in preparing a reply. This information will not be divulged without written authorization to anyone other than those within DOD for official use in determining performance.</p>
--

NETPDTC 1550/41 (Rev 4-00)

CHAPTER 1

RULES AND REGULATIONS

Masters-at-Arms (MAs) afloat and ashore normally are tasked with enforcing the rules and regulations on ships and shore installations. This chapter acquaints you with those rules and regulations you will be required to enforce.

Your responsibilities are not limited to the regulations in this chapter; you must have a good working knowledge of all the rules that you may be required to enforce including regulations at your own command.

You must also remember that in today's Navy changes are taking place rapidly and those changes may affect the existing rules and regulations. It is your responsibility to keep abreast of the times and to respond to necessary changes.

U.S. NAVY REGULATIONS

LEARNING OBJECTIVES: State the purpose of Navy Regulations. Explain the rights and responsibilities of Navy personnel according to U.S. Navy Regulations.

The United States (Continental) Navy came into being early in the Revolutionary War. On 13 October 1775 the Continental Congress voted to outfit two swift vessels and formed a legislative committee to oversee naval matters. On the committee was John Adams, a firm believer in having a strong naval force. Foreseeing the need for guidelines in discipline and administration, the committee presented to Congress a set of rules for governing the Navy. These rules were largely the work of Adams who based them on British Navy Regulations with some original articles of his own. Titled "Rules for the Regulation of the Navy of the United Colonies of North America," the 44 articles were approved by Congress in November 1775. Many of the articles, in modernized form, are part of today's Navy Regulations.

PURPOSE

United States Navy Regulations, 1990, is the principal regulatory document of the Department of

the Navy, endowed with the sanction of law as to duty, responsibility, authority, officials, and individuals. No other regulations that conflict with, alter, or amend any provision of *Navy Regulations* are to be issued within the Department of the Navy.

RESPONSIBILITY

The Chief of Naval Operations (CNO) is responsible for making sure *Navy Regulations* conform to the current needs of the Department of the Navy. When any person in the Department of the Navy deems it advisable that a correction, change, or addition be made to *Navy Regulations*, a draft of the proposed correction, change, or addition will be forwarded, with a statement of the reasons therefore, to the CNO via the chain of command.

RIGHTS AND RESPONSIBILITIES

All members of the naval service should acquaint themselves with, obey, and within their authority, enforce the laws, rules, and regulations pertaining to the Department of the Navy. The following regulations, from United States Navy Regulations, 1990, are of particular interest to you as an MA. Not all regulations are quoted in their entirety.

Conduct

Requirements of exemplary conduct are explained as follows.

ARTICLE 1131.— "All commanding officers and others in authority in the naval service are required to show in themselves a good example of virtue, honor, patriotism, and subordination; to be vigilant in inspecting the conduct of all persons who are placed under their command; to guard against and suppress all dissolute and immoral practices, and to correct, according to the laws and regulations of the Navy, all persons who are guilty of them; and to take all necessary and proper measures, under the laws, regulations, and customs of the naval service, to promote and safeguard the morale, the physical well-being and the general welfare of the officers and enlisted persons under their command or charge."

ARTICLE 1110.— “All Department of the Navy personnel are expected to conduct themselves in accordance with the highest standards of personal and professional integrity and ethics. At a minimum, all personnel shall comply with directives issued by the Secretary of Defense and the Secretary of the Navy regarding the Standards of Conduct and Government Ethics.”

Sexual Harassment and Fraternization

Navy Regulations clearly prohibit sexual harassment and fraternization within the naval service. The following two articles apply.

ARTICLE 1166.— Sexual Harassment. Sexual harassment is prohibited. No individual in the Department of the Navy should:

- Commit sexual harassment
- Take reprisal action against a person who provides information on an incident of alleged sexual harassment
- Knowingly make a false accusation of sexual harassment; or
- While in a supervisory or command position, condone or ignore sexual harassment of which he or she has knowledge or has reason to have knowledge

ARTICLE 1165.— Fraternization. Personal relationships between officer and enlisted members that are unduly familiar and that do not respect differences in grade or rank are prohibited. Such relationships are prejudicial to good order and discipline and violate long-standing traditions of the naval service.

When prejudicial to good order and discipline or of a nature to bring discredit on the naval service, personal relationships between officer members or between enlisted members that are unduly familiar and that do not respect differences in grade or rank are prohibited. Prejudice to good order and discipline or discredit to the naval service may result from, but are not limited to circumstances which:

- Call into a question a senior’s objectivity
- Result in actual or apparent preferential treatment
- Undermine the authority of a senior; or
- Compromise the chain of command

Accusations, Replies, and Countercharges

Whenever an accusation is made against another person in the naval service, either by report or by endorsement upon a communication, a copy of the report or endorsement should be furnished the accused at the time the accusation is submitted.

Any reports or complaints, and statements submitted in reply to or explanation of written accusations, should be written in temperate language and should be confined to pertinent facts. Opinions should not be expressed nor the motives of others discredited.

Persons to whom reports or complaints are submitted for statement should not reply by making countercharges.

Persons in the naval service who consider themselves wronged by an act, omission, decision, or order of a person who is superior in rank should be respectful toward that superior, but may report the alleged wrong to the proper authority for redress in the manner described in Article 1150, *United States Navy Regulations*, 1990. The report should clearly identify the superior against whom the accusation is made, the wrong complained of, and the redress desired. The person submitting the report or complaint may be held accountable by the senior who is responsible for the resolution of the report if the report is found to be frivolous or false.

Making of Gifts or Presents

No person in the Department of the Navy should at any time solicit contributions from other persons in the naval service or from other officers, clerks, or employees in the government service for a gift or present to persons in superior official positions; nor should any persons in such superior official positions receive any gift or present offered or presented them as a contribution from persons in government employ (including persons in the naval service) receiving a less rate of pay than themselves, nor should any person make any donation as a gift or present to any such official superiors. However, regulations do not prohibit a voluntary gift of nominal value or donation in nominal amount made on a special occasion such as marriage, illness, or retirement.

No person in the Department of the Navy should solicit subscriptions for the purpose of making a gift

to a member of the immediate family of a person in a superior official position.

Lending Money and Engaging in a Trade or Business

The following are articles of *U.S. Navy Regulations* regarding lending money and engaging in a trade or business.

ARTICLE 1112.— “No person in the naval service on active service, who makes a loan of money to another member of the armed services, shall knowingly charge, demand, or receive money or other property, constituting interest, in an amount or having a fair value in excess of eighteen percent per year simple interest. Interest on such a loan for a period other than one year shall not exceed the equivalent simple interest rate for such period. Unless authorized by his commanding officer or higher authority, no person in the naval service on active service, either for himself or as an agent for another, shall engage in trade or business on board any ship of the Navy or within any naval activity or introduce any article for purposes of trade on board any ship of the Navy or within any naval activity. The regular or systematic extension of loans for profit is within the meaning of the term “business” for purposes of this article.”

ARTICLE 1111.— “No officer shall borrow money or accept deposits from, or have any pecuniary dealings with an enlisted person, except as may be required in the performance of his or her duty, and except for the sale of an item of personal property which is for sale to other persons under the same conditions of guarantee and for the same consideration, and never having been property of the government.”

ARTICLE 1113.— “Except as necessary during contract administration, to determine specification or other compliance, no person in the Department of the Navy, in his or her official capacity, shall endorse or express an opinion of approval or disapproval of any commercial product or process.”

Possession of Weapons

Navy Regulations prohibit the possession of dangerous weapons and other devices except as indicated as follows.

ARTICLE 1159.— “Except as may be necessary to the proper performance of his duty or as may be authorized by proper authority, no person in the naval service shall:

a. Have concealed about his/her person any dangerous weapon, instrument or device; or any highly explosive article or compound.

b. Have in his/her possession any dangerous weapon, instrument, or device or any highly explosive article or compound on board any ship, craft, aircraft, or in any vehicle of the naval service or within any base, or other place under naval jurisdiction.”

In reading Article 1159, you will note that “dangerous weapon, instrument, or device” is not specifically described. Local directives should describe such instruments. Local directives should also be consulted to determine what instruments may be possessed and under what circumstances.

Personal, Government, and Public Property

Articles of *U.S. Navy Regulations* regarding personal, government, and public property are listed as follows.

ARTICLE 1160.— “No person in the Department of the Navy shall have in his possession any property of the United States, except as may be necessary to the proper performance of duty or as may be authorized by proper authority.”

ARTICLE 1161.— “The clothing, arms, and accouterments which are sold or issued by the United States to any person in the naval service shall not be sold, bartered, exchanged, pledged, loaned or given away, except as may be authorized by proper authority. Persons in the naval service shall not have in their possession, without permission from proper authority, any article of wearing apparel or bedding belonging to any other person in the naval service.”

Alcohol and Drugs

Articles of *U.S. Navy Regulations* regarding alcohol and drugs are listed as follows.

ARTICLE 1162.— “Except as may be authorized by the Secretary of the Navy, the introduction, possession or use of alcoholic beverages on board any ship, craft, aircraft, or in any vehicle of the Department of the Navy is prohibited. The transportation of alcoholic liquors for personal use ashore is authorized, subject to the discretion of the officer in command or

officer in charge, or higher authority, when the liquors are delivered to the custody of the officer in command or officer in charge of the ship, craft, or aircraft in sealed packages, securely packed, properly marked and in compliance with customs laws and regulations, and stored in securely locked compartments, and the transportation can be performed without undue interference with the work or duties of the ship, craft, or aircraft. Whenever alcoholic liquor is brought on board any ship, craft, or aircraft for transportation for personal use ashore, the person who brings it on board shall at that time file with the officer in command or officer in charge of the ship, craft, or aircraft, a statement of the quantity and kind of alcoholic liquor brought on board by him, together with a certification that its importation will be in compliance with customs and internal revenue laws and regulations and applicable State or local laws and laws at the place of debarkation.

The introduction, possession, and use of alcoholic beverages for personal consumption or for sale is authorized within naval activities and other places ashore under naval jurisdiction to the extent and in such manner as the Secretary of the Navy may prescribe.”

ARTICLE 1138.— All personnel shall endeavor to prevent and eliminate the unauthorized use of marijuana, narcotics, and other controlled substances within the naval service.

The wrongful possession, use, introduction, manufacture, distribution, and possession, manufacture, or introduction with intent to distribute, of controlled substances by persons in the naval service are offenses under Article 112a, *Uniform Code of Military Justice* (UCMJ).

The term *controlled substance* means a drug or other substance included in Schedule I, II, III, IV, or V established by section 202 of the Comprehensive Drug Abuse Prevention and Control Act of 1970 (84 Stat. 1236), as updated and republished under the provisions of that Act.”

REGULATIONS

Because *United States Navy Regulations, 1990*, is readily available at most commands (all MA units should have a copy), the regulatory articles will only be touched upon and excerpts displayed in this manual.

Inspection, Muster, and Sighting of Personnel

The commanding officer should hold periodic inspections of the material of the command, not on weekends or holidays, to determine deficiencies and cleanliness. When the size of the command prevents completion of the inspection in a reasonable time, the commanding officer (CO) should designate zones to be inspected by heads of departments or other responsible officers and should personally inspect at least one zone, alternating the zone(s) so that the entire command will be inspected at minimum intervals.

The CO should make sure, consistent with their employment, the personnel under his or her command present at all times a neat, clean, and military appearance. To assist in attaining this standard of appearance, the CO should, in the absence of operational commitments, hold periodic personnel inspections. Saturday inspections may be held at sea and in port and ashore, with personnel in duty status as participants. Otherwise, inspections should not be held on weekends or holidays.

Quarters or formations are for the purpose of ceremony, inspection, muster, instruction, or passing of orders and should be reserved for those occasions when such purpose cannot otherwise be achieved.

The prohibitions concerning weekend or holiday inspections do not apply to commands engaged in training reservists and to other commands with the consent of a superior.

The CO should require a daily report of all persons confined, a statement of their offenses, and the dates of their confinement and release.

The presence of all persons attached to the command should be accounted for daily. Persons who have not been sighted by a responsible senior will be reported absent.

Unauthorized Persons on Board

The CO will make sure that there is no unauthorized person on board before proceeding to sea or commencing a flight

Control of Passengers

Control of passage in and protracted visits to aircraft and ships of the Navy by all persons, within or without the Department of the Navy, will be exercised by the CNO.

This should not be interpreted as prohibiting the senior officer present from authorizing the passage in

ships and aircraft of the Navy by such persons deemed necessary in the public interest or in the interest of humanity.

Relations With Organizations and Military Personnel Embarked for Passage

Personnel of the naval service, other United States armed forces or services, and foreign armed forces are subject to the orders of the CO of the ship or aircraft commander. The provisions of this article should be applied to organizations and personnel of foreign armed forces, insofar as is feasible, with regard for their customs and traditions.

The CO of the ship or the aircraft commander should respect the identity and integrity of organizational units; and

The CO should require that personnel wear the uniform that corresponds as nearly as possible to the uniform prescribed for ship's company.

The CO has the power and authority to order an offender placed in naval or military custody as considered desirable, but in all cases where the offender is to be disembarked for disciplinary action by military authority, the offender should be placed in military custody on board the ship or aircraft, if possible.

When an organized unit is embarked for transportation only in a ship of the Navy, the officer in command of such organized unit should retain the authority over such unit before embarkation, including the power to order special or summary courts-martial upon enlisted persons under his or her command; but nothing in this paragraph will impair the authority of the CO of the ship over all persons embarked therein.

Persons Found Under Incriminating Circumstances

The CO should keep under restraint or surveillance, as necessary, any person not in the armed services of the United States who is found under incriminating or irregular circumstances within the command and should immediately start an investigation.

Should an investigation indicate that such person is not a fugitive from justice or has not committed or attempted to commit an offense, that person should be released at the earliest opportunity, except as follows:

- If not a citizen of the United States, and the place of release is under the jurisdiction of the United States, the nearest federal immigration authorities should be notified as to the time and place of release sufficiently in advance to permit them to take such steps as they deem appropriate.

- Such persons should not be released in territory not under the jurisdiction of the United States without first obtaining the consent of the proper foreign authorities, except where the investigation shows that he or she entered the command from a territory of the foreign state, or is a citizen or subject of that state.

If the investigation indicates that such person has committed or attempted to commit an offense punishable under the authority of the CO, the latter should take such action as deemed necessary.

If the investigation indicates that such a person is a fugitive from justice, or has committed or attempted to commit an offense that requires actions beyond the authority of the CO, that person should be delivered to the proper civil authorities at the first opportunity, with full descriptive data, fingerprints, and a statement of the circumstances.

Dealers, Tradesmen, and Agents

In general, dealers, tradesmen, or their agents should not be admitted within a command, except as authorized by the CO to do the following:

- Conduct public business
- Transact specific private business with individuals at the request of the latter
- Furnish services and supplies that are necessary and are not otherwise, or are insufficiently, available to the personnel of the command.

Observance of Sunday

Except by reason of necessity or in the interest of the welfare and morale of the command, the performance of work should not be required on Sunday. Except by reason of necessity, ships should not be sailed nor units of aircraft or troops be deployed on Sunday. The provisions of this paragraph need not apply to commands engaged in training Reserve components of the Navy and the Marine Corps.

Divine services should be conducted on Sunday if possible. All assistance and encouragement should be given to chaplains in the conduct of these services, and

music should be made available, if possible. The chaplain should be permitted to conduct public worship according to the manner and form of the church he or she represents. A suitable space should be designated and properly rigged for the occasion. Quiet should be maintained throughout the vicinity during divine services. The religious preferences and the varying religious needs of individuals should be recognized, respected, encouraged, and ministered to, if possible. Daily routine in ships and activities should be modified on Sunday if possible to achieve this end.

Publishing and Posting Orders and Regulations

According to Article 137 of the UCMJ, the articles specifically counted therein should be carefully explained to each enlisted person as follows:

1. At the time of entrance on active duty or within 6 days thereafter
2. Again, after completion of 6 months' active duty
3. Again, upon the occasion of each reenlistment

A text of the articles specifically counted in Article 137 of the UCMJ should be posted in a conspicuous place or places, readily accessible to all personnel of the command.

Instructions concerning the UCMJ and appropriate articles of *Navy Regulations* should be included in the training and educational program of the command.

Such general orders, orders from higher authority, and other matters that the CO considers of interest to the personnel or profitable for them to know should be published to the command as soon as possible. Such matters should also be posted in whole or in part, in a conspicuous place or places readily accessible to personnel of the command.

Upon the request of any person on active duty in the armed services, the following publications should be made available for personal examination:

- A complete text of the UCMJ
- Manual for Courts-Martial
- Navy Regulations, 1990
- Manual of the Judge Advocate General
- Naval Military Personnel Manual.

Delivery of Personnel to Civil Authorities and Service of Subpoena or Other Process

COs or other persons in authority should not deliver any person in the naval service to civil authorities except as provided by the *Manual of the Judge Advocate General*.

COs are authorized to permit the service of a subpoena or other process as provided by the *Manual of the Judge Advocate General*.

Search by Foreign Authorities

The CO should not permit a ship under his or her command to be searched on any pretense whatsoever by any person representing a foreign state, nor permit any personnel within the confines of the command to be removed from the command by such person, so long as the CO has the capacity to repel such an act, If force should be exerted to compel submission, the CO is to resist that force to the utmost of his or her power.

Except as may be provided by international agreement, the CO of a shore activity will not permit his or her command to be searched by any person representing a foreign state, nor permit any of the personnel within the confines of that command to be removed from the command by such person, so long as the CO has the power to resist.

Prisoners of War

On taking or receiving prisoners of war, the CO must make sure such prisoners are treated with humanity; their personal property is preserved and protected; they are allowed the use of such of their effects as may be necessary for their health; they are supplied with proper rations; they are properly guarded and deprived of all means of escape and revolt, and the applicable provisions of the 1949 Geneva Conventions relative to the treatment of prisoners of war are followed.

Proper Use of Labor and Materials

No government materials should be diverted from their intended use, except for proper purposes, nor should any buildings or portions thereof be occupied or used by other than authorized persons.

Civilian employees who are paid from appropriated funds should not be permitted to perform, during the hours for which they are paid from such funds, any work other than that authorized to be

done for the government, or as otherwise prescribed by the Secretary of the Navy (SECNAV).

Customs and Immigration Inspections

The CO or aircraft commander should facilitate any proper examination that it may be the duty of a customs officer or an immigration officer of the United States to make on board the ship or aircraft under his or her command. The CO should not permit a foreign customs officer or an immigration officer to make any examination whatsoever, except as hereinafter provided, on board the ship, aircraft, or boats under his or her command.

When a ship or aircraft of the Navy or a public vessel manned by naval personnel and operating under the direction of the Department of the Navy is carrying cargo for private commercial account, such cargo should be subject to the local customs regulations of the port, domestic or foreign, in which the ship or aircraft may be, and in all matters relating to such cargo, the procedure prescribed for private merchant vessels and aircraft should be followed. Government-owned stores or cargo in such ship or aircraft not landed nor intended to be landed nor in any manner trafficked in, are, by the established precedent of international courtesy, exempt from customs duties, but a declaration of such stores or cargo, when required by local customs regulations, should be made. COS should prevent, as far as possible, disputes with the local authorities in such cases, but should protect the ship or aircraft and the government-owned stores and cargo from any search or seizure.

Manner of Addressing Officers

Except as provided in the following paragraph, every officer in the naval service should be designated and addressed in official communications by the title of his or her grade preceding the name.

In oral official communications, officers will be addressed by their grade except that officers of the Medical Corps, the Dental Corps, and those officers of the Medical Service Corps and the Nurse Corps having doctoral degrees may be addressed as Doctor, and officers of the Chaplain Corps may be addressed as Chaplain. When addressing an officer whose grade includes a modifier, the modifier may be dropped.

Exercise of Authority

All persons in the naval service on active service, those on the Retired List with pay, and transferred members of the Fleet Reserve and the Fleet Marine Corps Reserve are at all times subject to naval authority. While on active service they may, if not on leave of absence except as noted as follows, on the sick list, taken into custody, under arrest, suspended from duty, in confinement, or otherwise incapable of discharging their duties, exercise authority over all persons who are subordinate to them.

A person in the naval service, although on leave, may exercise authority as follows:

- When in a naval ship or aircraft and placed on duty by the CO or aircraft commander
- When in a ship or aircraft of the armed services of the United States, other than a naval ship or aircraft, as the CO of naval personnel embarked, or when placed on duty by such officer
- When senior officer at the scene of a riot or other emergency, or when placed on duty by such officer

Authority Over Subordinates

All officers of the naval service of whatever designation or corps should have all the necessary authority for the performance of their duties and should be obeyed by all persons of whatever designation or corps who are, according to with these regulations and orders from competent authority, subordinate to them.

Delegation of Authority

The delegation of authority and the issuance of orders and instructions by a person in the naval service should not relieve such person from any imposed responsibility. He or she should make sure that the delegated authority is properly exercised and orders and instructions are properly executed.

Abuse of Authority

Persons in authority are forbidden to injure their subordinates by tyrannical or erratic conduct or by abusive language.

Contradictory and Conflicting Orders

If an enlisted person in the naval service receives an order that annuls, suspends, or modifies one received from another superior, that person should immediately represent the facts to the superior from whom the last order was received. If, after such representation, the superior from whom the last order was received should insist upon the execution of that order, it will be obeyed. The person receiving and executing such order should report the circumstances, as soon as possible, to the superior from whom the original order was received.

Authority of Officers Embarked as Passengers

The CO of a ship or aircraft, not a flagship, with a flag officer eligible for command at sea embarked as a passenger, will be subject to the orders of such flag officer. Other officers embarked as passengers, senior to the CO, will have no authority over the CO.

Officers embarked as passengers who are junior to the CO, or the CO of the transport unit of a ship of the Military Sealift Command (MSC), if not on the staff of an officer also embarked, may be assigned to duty when the needs of the service require it. The CO or the CO of the transport unit will be the judge of such necessity. Passengers thus assigned will have the same authority as though regularly attached to the ship.

Shore Patrol

When liberty is granted to any considerable number of persons, except in an area that can absorb them without danger of disturbance or disorder, the senior officer present will cause to be established, temporarily or permanently, in charge of an officer, a sufficient patrol of officers, petty officers, and noncommissioned officers to maintain order and suppress any unseemly conduct on the part of any person on liberty. The senior patrol officer should communicate with the chief of police or other local officials and make such arrangements as may be possible to aid the patrol in carrying out its duties properly. Such duties may include providing assistance to military personnel in relations with civil courts and police, arranging for release of service personnel from civil authorities to the parent command, and providing other services that favorably influence discipline and morale.

A patrol will not be landed in any foreign port without first obtaining the consent of the proper local

officials. Tact must be used in requesting permission, and, unless it is given willingly and cordially, the patrol will not be landed. If consent cannot be obtained, the size of liberty parties should be held to such limits as may be necessary to render disturbances unlikely.

Officers and enlisted personnel on patrol duty in a foreign country normally should not be armed. In the United States, officers and enlisted personnel may be armed as prescribed by the senior officer present.

No officer or enlisted person who is a member of the shore patrol or beach guard or is assigned in support thereof should partake of or indulge in any form of intoxicating beverage or other form of intoxicant while on duty, on post, or at other times prescribed by the senior patrol officer. The senior patrol officer should make sure the provisions of this paragraph are strictly observed and should report promptly in writing to the senior officer present all violations of these provisions that may come to his or her notice. All officers and enlisted personnel of the patrol should report to the senior patrol officer all violations of the provisions of this paragraph on the part of those under them.

STANDARD ORGANIZATION AND REGULATIONS OF THE U.S. NAVY

LEARNING OBJECTIVES: Describe the purpose of the Standard Organization and Regulations of the U.S. Navy OPNAVINST 3120.32, and also explain the general regulations according to OPNAVINST 3120.32.

The Standard Organization and Regulations of the U.S. Navy (SORM), OPNAVINST 3120.32, is applicable to all members of the U.S. Navy. Its purpose is to issue regulations and guidance governing the conduct of all members of the U.S. Navy. The regulations included in the manual are not intended to contradict or supersede any provision of Navy Regulations.

As an MA, you should know and understand the contents of the SORM as it provides guidance in performing the duties of the MA, defines U.S. Navy and unit organization, and outlines regulations that you may be responsible for enforcing. This chapter only discusses the regulations. The material in the SORM that is printed in italicized type is regulatory

and applies to each member of the U.S. Navy. Violation of any provision of these regulations is punishable under the UCMJ. The material printed in plain type in the SORM is for the guidance of commanders, COs, and officers in charge (OICs).

DUTIES OF WATCHES

As an MA, you may be tasked with the responsibility for posting watches/sentries and/or have various watches/sentries reporting to you. You will be required to have a thorough knowledge of the duties of watches, understand the watchstanding principles and regulations of those watches that you have posted, or those that are reporting to you.

No person, while on duty as a member of a patrol or as a sentry, should fail to report all violations of the unit's regulations, unit's directives, and other breaches of good order and discipline; or, observing a violation of regulations or of good order and discipline, fail to exert himself or herself to the utmost to suppress such violations; or fail to report any violation of safety precautions or safety regulations known to him or her that he or she may observe; or observing such violations, fail to exert himself or herself to the utmost to suppress such violations and other malpractice that may endanger the safety or security of a naval unit and its personnel.

A watch stander assigned a watch will be responsible for the proper performance of all duties prescribed for the watch. Personnel on watch under that watch stander will be subject to his or her orders. The watch stander will instruct subordinates as may be necessary and will endeavor to foresee emergency situations that may arise and prepare to take appropriate remedial actions. The watch stander will remain alert and will require subordinates, if any, to be attentive and ready for contingencies.

Orders or reports will be issued in the customary phraseology of the service.

The watch stander will promptly inform appropriate persons of matters pertaining to the watch of which they should be aware.

Before relieving, the watch stander will become thoroughly acquainted with all matters of which he or she should be aware to properly perform the duties. The watch stander may decline to relieve the previous watch should any circumstances or situations exist that, in the reliever's opinion, justify such action. The facts will be reported immediately to the appropriate authority and instructions will be requested.

The watch stander will not leave his or her post until properly relieved or secured by appropriate authority.

WATCHSTANDING PRINCIPLES

The proper functioning of the watch organization can be ensured only if all watch standers adhere to the following watchstanding principles:

- Watch standers will receive indoctrination and training to provide the requisite qualifications to perform the duties and functions to be carried out at the assigned watch station before being assigned to the watch.

- Watch standers will devote their full attention to the proper execution of the duties and responsibilities of the assigned watch station.

- Watch standers will frequently review all emergency procedures applicable to their assigned watch station so that they will be ready to execute emergency procedures without delay.

- Watch standers will not leave their assigned watch station unless properly relieved or when ordered by the OIC of the watch station.

- Throughout the course of the watch, watch standers will know to whom in the watch organization they report and all watch standers who report to them.

- While on watch, watch standers will not be assigned or assume any duties that may distract their attention from the proper execution of the duties to be carried out at the watch station.

- All watch standers authorized to carry arms should be instructed on the orders to sentries and the circumstances under which a weapon may be fired. Orders to sentries and the conditions under which armed watch standers are authorized to fire their weapons are set forth in the SORM. Watches requiring the carrying of arms will be assigned only to persons who have been trained in familiarization and actual firing of the weapon assigned.

PERFORMANCE OF DUTY ON WATCH

The following instructions are set forth as a general guide for standards to be met by all watch standers. Each person on watch will do the following:

- Be responsible for the proper performance of all duties prescribed for the watch. All persons under the watch stander will be subject to his or her orders.

- Remain responsible for the watch and remain on station until properly relieved. The watch stander will require the same of all persons on watch under him or her, The watch stander will instruct them as may be necessary on the performance of their duties and should make sure they are at their stations and are attentive, alert, and ready for duty. Watch standers will train themselves and their subordinates to foresee situations that may arise and to take such timely and remedial action as may be required.

- At all times conduct themselves in a smart and military manner befitting the status of a person on watch.

- Use the appropriate phraseology, customary to the service, when issuing orders and making reports.

- Demand of themselves and others formality in all relationships while on watch.

- Promptly inform the appropriate persons of matters pertaining to the watch that they should know for the proper performance of their duties.

- Make all required inspections and any such additional ones as are permitted and considered necessary to make sure that the duties of the watch are properly performed.

GENERAL REGULATIONS

The following general regulations are those regulations that are considered most pertinent to the MA and are by no means a complete list of all the regulations you may be responsible for enforcing. You should study the UCMJ, *U.S. Navy Regulations*, 1990, the SORM, and the instructions issued by your command.

Alarm Bells and the General Announcing System

No person will, without proper authority and due cause, tamper with, operate, or otherwise disturb any contact maker used to sound the general- or special-purpose alarms.

The general announcing system (IMC) will not be used without permission of the officer of the deck (OOD) except in emergencies. The use of this system will be restricted to matters of general importance. Words will not be passed for officers or enlisted persons except in emergencies or when their

immediate presence is necessary for the operation of the ship or equipment.

No person will strike the ship's bell or gong without permission of the OOD, and then only to indicate the time, as a fire alarm, or as a fog signal when at anchor.

Boat gongs will be sounded only by direction of the OOD to indicate the prospective departure of officers' boats and the arrival and departure of the CO and other senior officials. Boat gongs will be sounded in advance of the arrival or departure of the announced official.

Alcohol

Alcoholic beverages in transit and alcohol used for other purposes will be in the custody of the supply officer. These officers will supervise in person all receipts and issues of alcohol and alcoholic beverages in their custody and will keep proper records of all transactions to ensure strict responsibility and detect losses promptly. Only heads of departments are authorized to sign requests for the issue of alcohol. It will be drawn only in limited quantities sufficient for immediate use and will be issued only to responsible petty officers. The person to whom alcohol is issued for use will be responsible for making sure it is used only for the purpose for which issued; it is withheld from unauthorized persons; it is protected from theft; and the unused portion is returned immediately to the officer from whom it was drawn. The bulk alcohol should, if possible, be kept in a three-combination safe or, if this is not possible, under lock and key. Alcohol should be inventoried monthly by a special inventory board appointed by the CO for this purpose.

Armed Forces Identification Cards and Leave Papers

No person without proper authority shall do the following:

- Have in his or her possession more than one properly validated Armed Forces identification card.

- Depart from the unit on liberty without his or her own properly validated identification card; or, in the case of leave, depart from the unit without his or her own properly validated leave papers and identification card.

- Have in his or her possession a false or unauthorized identification card; or a mutilated, erased, altered,

or not properly validated identification card; or an identification card bearing a name, grade, service number, and date of birth other than his or her own name, grade, service number, and date of birth.

- Return to the unit from leave without depositing his or her leave papers with the proper authority. Any person returning who does not have an identification card will report to the OOD in person and inform him or her of the loss.

- The Armed Forces Liberty Pass, DD Form 345, may be used to control the authorized absence (other than leave) of enlisted members when, in the judgment of the CO or a senior officer in the chain of command, it is deemed necessary for security, operational, or other special circumstances. Such liberty pass issue will be according to the NAVMILPERSMAN.

Arrest by Civil Authorities

If arrested or detained by civil authorities, all persons will communicate quickly with the CO (OOD) and state the facts concerning such arrest or detention.

Berthing

No person should do the following:

- Sleep in any spaces or use any bunk or berth other than that to which assigned, except as may be authorized by proper authority.

- Sleep in or lie on any bunk or berth while clothed in dungarees or working clothes or while wearing shoes.

- Smoke while sitting or lying on any bunk or berth or smoke in any berthing space during the night hours between taps and reveille.

- Remove any mattress from any bunk or place of stowage or place such mattress on the deck or in any place other than a bunk, except as may be authorized by proper authority.

- Create a disturbance or turn on any white light in any berthing space or living space during the night hours between taps and reveille, except as may be necessary for the performance of duty.

- Fail to turn out of his or her bunk at reveille, except when on the sick list or authorized to late bunk.

- Be authorized late bunk privileges unless he or she has had a midwatch or made a boat trip as a crew member after 2200 the previous day or is specifically

authorized late bunk privileges by the executive officer (XO) or command duty officer (CDO). All late sleepers will turn out at 0700.

Card Games and Gambling

No person will gamble for money with playing cards, dice, or other apparatus on board naval units or engage in any card games or other games during prescribed working hours, during the night hours between taps and reveille, or during divine services.

Civilian Clothing

Unless the SECNAV directs that uniforms be worn at all times and except as noted in U.S. Navy Uniform Regulations, civilian clothing may be worn by officers and enlisted personnel according to the regulations outlined later in this chapter.

Concessions

Particular attention is directed to those sections of the U.S. Navy Regulations and the NAVSUP P-487 concerning concessions or dealings with tradesmen. No concessions will be granted nor any arrangement made with dealers or tradesmen by which they are allowed to make sales by agreements to pay a portion of their profit to the ship's store. This applies equally to "internal" concessions, and all items sold aboard naval units for profit (for example, popcorn and canned beverages) must be handled through the ship's store.

Contagious and Communicable Diseases

Any person contracting a communicable disease must be isolated immediately upon detection. Drafts of incoming members will be examined and appropriate action taken to prevent the spread of communicable diseases. To minimize the spread of contagious diseases, all mess gear and food containers must be sterilized and proper sanitary precautions must be effected in washrooms, laundries, and barbershops.

Quarantine diseases must be reported to higher authority according to current directives.

The medical officer must submit a medical quarantine list upon entering port and before to granting liberty. A new list must be submitted whenever changes occur. The medical quarantine list

must be forwarded to the CO via the XO with copies to all department heads and the CDO/OOD.

Division officers must check the medical quarantine list and deny liberty and leave to all personnel on the medical quarantine list.

Crew's Heads and Washrooms

Crew's heads and washrooms will be open at all times except when closed for cleaning according to the prescribed daily cleaning schedule.

No person will loiter or dry clothing in any crew's head or washroom or throw rubbish or other solid matter into bowls or urinals.

Customs

Upon arrival of a naval unit in United States territory after visiting a foreign port, the unit is subject to customs and other inspections by federal authorities. On such occasions, customs declarations will be distributed to all hands in sufficient time to be filled out and returned before arrival in port.

It shall be the duty of all personnel to accurately complete customs declarations prior to the arrival of the ship in port.

No person without permission from the commanding officer shall bring on board any article, animal, or any other thing, the introduction of which into U.S. territory is forbidden or restricted under current regulations.

Divine Services

All persons who do not desire to attend divine services should keep clear of the area in which services are being conducted and should refrain from words, sounds, or actions that would interfere with the service.

No person will conduct himself or herself in a manner that would interfere with divine services.

Electrical and Electronic Equipment

The use of privately owned electrical equipment on board naval ships creates a fire hazard as well as a hazard to the personal safety of individuals using such equipment. In addition, radios, phonographs, and other electronic equipment have emissive properties that may compromise the radio security of the ship.

Therefore, no privately owned electrical equipment will be used on board naval ships except that specifically authorized by the XO after it has been inspected and approved for use by the engineer officer or a designated representative. The electronic material officer will make a similar inspection of electronic equipment.

No persons other than those specifically authorized will operate electrically powered machinery.

No persons will operate an electrically powered hand tool unless it has been properly grounded and then only when specifically authorized to use such equipment.

No person will possess on board naval ships any electrical appliance other than an electric shaver and/or an electric toothbrush except as may be authorized by the XO; or when authorized, use such electrical equipment in any space or in any manner other than that for which it was authorized.

Emergency Equipment

No person should use emergency equipment for any purpose other than that for which it is intended. Emergency equipment includes such items as battle lanterns, emergency first aid boxes, shores, wrenches, life rings, equipment in life rafts and boats, handybillys, fire hoses, and fuel for emergency machinery.

False Statements

No person will, in any official capacity, knowingly and willfully make any false, fictitious, or fraudulent statements or representations or make use of any false writing or documents knowing the same to contain any false, fictitious, or fraudulent statement or entry.

Freshwater

The demands placed on ship's evaporators for makeup feed water and water for washing, cooking, and drinking make it mandatory that every person on board ship practice the utmost prudence and economy in the use of fresh water. The galleys, sick bay, and laundry are authorized to use only that amount of freshwater that is consistent with cleanliness and sanitation. Freshwater may be used for general cleaning purposes at such times as may be directed by the CO.

Salt water will not be used for cleaning purposes in any food preparation spaces, nor will saltwater connections be permitted in these spaces.

Cross connections between freshwater and saltwater systems or other systems that may contaminate the potable water are not to be permitted.

No person will willfully waste, or lose, or cause the loss of any freshwater on board ships.

Government Property

No person should do the following:

- Conceal or fail to report to proper authority the loss, removal, destruction, or damage of government property entrusted to his or her care or custody.

- Remove without proper authority from its regular place of stowage or location, for any purpose whatever, any particle of government property, including stores, foodstuffs, hull and damage control fittings, first aid equipment, and lifesaving and emergency equipment.

- Possess any article of government property except as may be necessary for the performance of duty or as may be authorized by authority.

Health, Sanitation, and Messing

All persons must report promptly to the medical officer the existence or suspicion of any communicable diseases in themselves or in persons with whom they are living or otherwise come in contact.

All persons must report immediately for medical treatment if they have any discharge, inflammation, or sores about their parts; or if they have displayed other symptoms of a venereal disease; or if they are aware that they have contracted a venereal disease.

No person suffering from infections or from a communicable contagious disease will be assigned to duty on the messdecks, in stores areas, or on working parties engaged in handling provisions.

The reporting and treatment of a venereal disease is a personal and confidential matter and no disciplinary action will be taken for having contracted the venereal disease itself.

Hitchhiking

No naval personnel will, on a public road, street, or highway, endeavor by words, gestures, or otherwise to beg, solicit, or hitchhike a ride in or on any motor vehicle. Accepting rides at authorized service personnel pickup stations is authorized.

Inspection of Property

Personnel should not refuse to present for inspection by the OOD or an authorized representative any item of baggage or article in their possession or on their persons or knowingly conceal in any container or on their persons any article with intent to deceive or evade the lawful inspection of such articles.

Intoxicated Persons

The OOD or the CDO must make sure that all persons who return on board in an intoxicated condition, or who are found on board intoxicated, are promptly examined by the medical officer or his or her qualified representative. Additional guidance can be found in COMNAVSURFLANTINST 6000.1 or COMNAVSURFPACINST 6000.1. All persons who are intoxicated to such an extent as to create a disturbance or to make their being at large dangerous to their personal safety or to the safety of the unit must be placed under protective restraint upon direction of the CO, the CDO, or the OOD. Only such restraint as is necessary to ensure the cessation of the disturbance or to ensure the personal safety of the individual concerned or the safety of the unit may be imposed.

Leave and Liberty

No person will proceed from the confines of a naval unit for any reason whatever without permission of proper authority.

No person will proceed from the confines of a naval unit for any reason whatever while knowingly in a restraint status without permission of the CO, the XO, or, in emergencies, the CDO.

No person will proceed from the confines of a naval unit for any reason whatever while knowingly on the sick list, binnacle list, or the venereal disease restricted list, unless such a person's name is removed from the list by the medical officer, and then only with proper authority.

No person will fail to report his or her departure from or return to a naval unit to the OOD or an authorized representative.

Lights

No person will turn on any white lights, other than standing lights, during the hours between taps and reveille, in any living space, passageway, office, messdeck, lounge or recreation area, control room, shop, machinery space, or other working space, unless such light is incident to the performance of duty or authorized by proper authority.

During periods when the unit is darkened, only flashlights or hand lanterns that have been altered to produce a dim red light will be lighted on any weather deck or in any space visible from without. Further, such lights will be used only when necessary for the performance of duty.

Locked Spaces

No person will have possession of the key to any space on board a naval unit other than the locker that is regularly assigned for the stowage of his or her personal property, unless such key is used in the performance of his or her regularly assigned duties.

No person will lock from the inside any office, shop, or other space on board a naval unit to prevent access to such space from without, except as may be authorized by proper authority.

Mess Gear

The removal of mess gear from the messdecks is prohibited. The senior petty officer in charge of the compartment in which mess gear is found will be responsible for its immediate return to the messdecks.

Motor Vehicles

No person will operate a government-owned motor vehicle assigned to a naval unit unless he or she has been specifically designated to do so by the CO, and then only for the purpose of official unit business.

All persons operating government-owned motor vehicles must possess a valid U.S. Government operator's permit or a valid state driver's license and will comply with all post, station, local, state, and federal directives pertaining to the operation of motor vehicles.

All persons operating government-owned motor vehicles assigned to a naval unit should obtain the permission of the OOD before driving such vehicles away from the unit and should report to the OOD upon their return.

Arrival and departure reports of vehicles assigned to naval vessels may be made to the beach guard.

Narcotics and Other Controlled Substances

All narcotics and other controlled substances authorized for medical purposes should be in the custody of the medical or dental officer. No one should have access to this material except as prescribed by these officers or the CO.

The medical and dental officers should supervise in person all receipts and issues of narcotics and other controlled substances in their custody and should keep proper records of all transactions to ensure strict accountability and detect losses promptly.

With the exception of medical and dental officers, no person should prescribe or administer any narcotics or other controlled substances either to himself or herself or to another person, except to aid the injured during action or emergencies. The medical and dental officers may authorize certain hospital corpsmen and dental technicians to administer narcotics and controlled drugs to patients in sick bay in according to the medical and dental officer's prescription.

In units to which no medical officer is attached, all narcotics and dangerous drugs must be in the custody of the controlled medicinal custodian, except small quantities of necessary narcotics and dangerous drugs that may be issued to the leading petty officer in the medical department. The narcotics and dangerous drugs should, if possible, be kept in a three-combination safe or, if this is not possible, under lock and key. All transactions between the bulk custodian and medical department representative should be receipted for. Issues from the working stock in the sick bay should be covered by prescription. Narcotics and dangerous drugs must be inventoried monthly by a special inventory board appointed for this purpose.

Official Forms, Records, and Correspondence

No person, having possession, custody, or control of official correspondence forms or records, will knowingly deliver them or divulge their contents to any person not authorized to receive them.

No person will sell, barter, or trade official correspondence, records, or forms for monetary gain or other considerations.

Outfits, Uniforms, and Clothing

No person will wear on board a unit any article of clothing that is unduly frayed, torn, dirty, or otherwise mutilated.

No person will wear on board a unit any article of clothing that is not prescribed as part of the uniform of the day without permission of proper authority.

No person will wear or otherwise display on his or her person on board a unit any article of a naval uniform in a manner that would bring discredit to the naval service or, in a manner other than it was intended to be worn.

If he or she is an enlisted person, possess on board a unit without permission from proper authority any article of uniform clothing that is not legibly marked with the owner's name and/or service number; or any article of clothing or bedding marked with the name and/or service number of another person that has not been marked DC by the Chief Master-at-Arms (CMAA) and recorded in the DC clothing record book.

No person will sell, barter, exchange, lend, or give away any clothing, arms, military outfits, or equipment furnished by the government. No names, designs, or marks except the number prescribed for official identification will be placed on any foul weather clothing or other equipment furnished by the government.

Personal Effects

Personnel will not maintain personal belongings or other articles in their custody or possession in any locker closet, peacoat locker, or space other than that which is regularly assigned to them or which they have been authorized by proper authority to use.

Each person is responsible for obtaining a lock and keeping his or her personal locker locked at all times. Any evidence of tampering with locks or authorized entry into a personal locker will be reported to the CMAA immediately.

Personally Owned Tools and Materials

No person will take ashore any tools, materials, or equipment, regardless of whether they are government or personal property, unless such items are definitely

and specifically listed on a duly authenticated property pass.

Enlisted personnel desiring to bring personally owned tools, materials, or equipment on board for use or repair will, provided such items are similar to comparable government-owned items used in unit work or business, first obtain permission to do so from their division officer.

The division officer will immediately complete an itemized, descriptive inventory sheet of all personally owned tools, materials, or equipment brought on board and will maintain a permanent file of such inventories as a function of division administrative procedure. Each inventory sheet will be signed by both property owner and division officer.

Petitions, Protest, and Dissident and Related Activities

The right of expression of any person in naval service should be preserved to the maximum extent possible, consistent with good order and discipline and the national security. Commanders and COs, however, should be alert to any conduct that, if allowed to continue, would impair or destroy the effectiveness of their unit. It is necessary and appropriate for COs to learn the nature and purpose of all significant group activities, including activities of racist organizations, within their commands to the extent reasonably necessary to prevent unlawful conduct or conduct that would otherwise pose a danger to military loyalty, discipline, or morale of the military personnel of the command. In the event that such conduct is made known to the commander, he or she will promptly take appropriate measures including the reasonable application of force, if necessary, to terminate such illegal activity. For related guidance, refer to Article 138, UCMJ; Article 1401-3-(4) U.S. Navy Uniform Regulations; and OPNAVINST 1620.1.

Unless prior CO approval is obtained, no person in the naval service will engage or participate in picketing, demonstrations, sit-ins, political speeches, and similar activities on board any ship, craft, aircraft, or in any vehicle of the Department of the Navy; on any military installation; in a foreign country; or on duty or in uniform.

Unless prior CO approval is obtained, no person will originate, sign, distribute, or issue petitions or publications, including pamphlets, newspapers, magazines, handbills, flyers, or other printed or

written material on board any ship, craft, aircraft, or in any vehicle of the Department of the Navy; on any military installation; in a foreign country; on duty or in uniform.

Generally, peaceful meetings, assemblies, congregations, or group discussions by off-duty personnel are lawful and will not be prohibited. On the other hand, some group activities may be undertaken in a manner or may involve a subject matter that would render the activity illegal and, hence, subject to control or prohibition.

A commander or CO may control or prohibit the unauthorized activities described in this section if, in his or her judgment, the activity would do the following:

- Materially interfere with the safety, operation, command, or control of the ship, or the assigned duties of particular members of the command
- Present a clear danger to the loyalty, discipline, morale, or safety of personnel of his or her command
- Involve distribution of material or the rendering of advice or counsel that causes, attempts to cause, or advocates insubordination, disloyalty, mutiny, refusal of duty; solicits desertion; discloses classified information; or contains obscene or pornographic matter
- Involve the planning or perpetuation of an unlawful act or acts including acts of unlawful intimidation and violence, racially motivated or otherwise

Pets

Personnel will not possess or introduce on a naval unit any animals, birds, reptiles, or fish, for any purpose whatever, without permission of the CO.

Photographic Equipment

No person will have in his or her possession or introduce on board a naval unit any camera or other photographic equipment capable of exposing a photographic plate or film without permission of the CO or his or her authorized representative.

No person will make photographs of a naval unit or its equipment or of objects from the units without permission of the CO, and then only of the objects for which permission was specifically given.

While on watch or duty as a sentry or member of a patrol, no person will knowingly permit the introduction of any camera or photographic

equipment on board a naval unit unless such equipment is authorized by the CO or his or her authorized representative.

Plan of the Day

A plan of the day will be published daily by the XO or authorized representative and will constitute a medium for the issuance of such orders and directives as the XO may issue. When the XO is absent from the unit, the plan of the day will be issued by the duty officer.

The plan of the day will be posted on all department and division bulletin boards.

All persons will read the plan of the day each day. They are responsible for obeying applicable orders contained therein.

In port, the plan of the day will be read at quarters.

Profane Language

No person will use profane, obscene, or vulgar words or gestures on board a naval unit.

Discharge of Oil, Trash, and Garbage

Except as authorized by law or regulation, no oil, oily waste, or trash will be discharged into United States or foreign international waters or prohibited areas.

- The United States prohibited area is designated as waters within 50 miles of its coastline.

- Discharge or otherwise dispose of overboard any trash or rubbish within the "prohibited zone" as issued in OPNAVINST 6240.3. The prohibited zone extends to seaward for 50 miles or more from land in most foreign international waters.

- Discharge or otherwise dispose of overboard any garbage within the contiguous zone which extends to seaward 12 miles from the coastline.

- Throw overboard wood, trash, bottles, boxes, garbage, unpierced metal containers, or other floatable articles unless packaged to have negative buoyancy.

- Throw anything overboard at sea except at the fantail and then only with the permission of the OOD.

- Dispose of garbage by means other than those approved by the XO.

- Any oil slick within 50 miles of the United States coastline should be reported as soon as possible to the nearest Coast Guard district headquarters.

- When in port, dispose of refuse in any other place except designated trash lighters or receptacles on the pier.

- Throw any trash, chewing gum, or other waste materials in urinals, on deck, or in any other place other than designated trash receptacles.

Removal of Equipment From Ship

Before any of the unit’s allowance of equipment and spare parts are removed temporarily from the unit, permission is required as follows:

Item	Grants Permission
Correspondence and unit publications	Executive officer
Equipage and department publications	Cognizant officer
Spare parts	Supply officer cognizant officer

Before any unit’s equipment or spare parts are removed permanently (over 1 week), the CO must grant permission. This applies to items removed to the unit’s storeroom ashore.

Restricted Spaces

Restricted spaces will be entered only by authorized personnel and personnel in the performance of duty.

Sabotage or Willful Damage

Any person who has reason to believe that the ship is in danger of sabotage or willful damage will notify the OOD or the CDO.

Shipboard Traffic Routes

All persons will use the following routes when proceeding to their general quarters or emergency stations; forward and up on the starboard side; aft and down on the port side.

Small Arms

Small arms will be issued by the weapons officer or first lieutenant to watches, sentries, guard mail petty officers, and such other persons as maybe specifically authorized by the CO to carry sidearms. No arms will be issued for unofficial purposes. Personal small arms brought aboard a naval unit for transportation purposes will be turned in to the weapons officer or first lieutenant for custody.

No person will be issued arms until it is demonstrated to the weapons officer or first lieutenant, or designated representative that he or she has a knowledge of the operation of the piece and of all safety precautions incident to its use.

No person will insert a clip or otherwise load any small arms unless actually required to fire the piece in the performance of a duty. However, operational and administrative commanders’ procedures should provide sufficient authorization for security personnel charged with protection of highly sensitive areas (for example, nuclear weapons and sensitive ordnance storage) to load small arms in time to prevent excessive personal danger or inability to perform assigned tasks.

Swimming

Swimming over the side is prohibited without express approval of the CO.

Swimming over the side is expressly prohibited when in a harbor or other fleet concentrations without approval of senior officer present afloat (SOPA), or when in waters known or suspected to be contaminated.

Whenever swimming parties are authorized, two swimmers, qualified as lifeguards, will be posted and one boat and boat crew will be in the water in the vicinity of the swimming area.

All swimmers will remain within the designated boundaries of the swimming area.

Tampering

No person should tamper with, manipulate, or operate in any manner any hull fittings and equipment, damage control fittings and equipment, valves, electrical equipment and controls, machinery, ventilation controls and thermostats, or other equipment that is not his or her duty to operate, repair, or adjust.

Tax-Free Tobacco Products

Except for bulk sales to certain units under orders to proceed beyond the 3-mile limit of the United States, tax-free cigarettes may not be sold by unit stores activities within the 3-mile limit or international boundary, as the case may be, of the United States.

TIPPING

No person should accept any money or other compensation from a person on board a naval unit in return for a service that is his duty to perform or render, regardless of the circumstances incident to such service.

No person should give or offer any money or other compensation to any person on board a naval unit for a service performed in the line of duty, regardless of the circumstances incident to such service.

Unauthorized Alterations

No change or alteration will be made to any system or component without the approval of the CO. All changes, regardless of scope, will be entered in prints, instruction books, and material histories by the responsible petty officer. This does not waive the requirement for approval of ships' alterations by the Naval Sea Systems Command.

Unauthorized Articles

No person will possess on board a naval unit the property of another person in the naval service without permission from proper authority.

No person will purchase any dangerous weapons prohibited by Navy Regulations in any port outside the United States, unless authorization has been obtained in writing from the CO.

No person will possess on board a naval unit any lewd, lascivious, or obscene writing, photograph, or drawing; or offer, sell, or exhibit any lewd, lascivious, or obscene writing or drawing.

No person will possess on board a naval unit any medicines or drugs or consume or use any medicines or drugs except as may be authorized by the medical officer or by a prescription of a civilian doctor.

Unauthorized Entry

No person will enter any space on board a naval unit that is marked EXCLUSION, LIMITED, CONTROLLED, or RESTRICTED AREA or that is known to be a restricted area, except as may be necessary in the performance of duty.

If an enlisted person, no person will enter or pass through the wardroom, the wardroom galley, officers' staterooms, or any space marked OFFICERS' COUNTRY, or which is known to be officers' country, except as may be necessary in the performance of duty.

No person will enter any officer space or shop that is not his or her duty to enter.

LEADERSHIP

LEARNING OBJECTIVES: Identify the leadership responsibilities of U.S. Navy personnel. Describe six methods used to reward outstanding individuals.

As a leader, you are expected to serve as a good example to your subordinates. You must encourage, inspire, teach, and motivate your personnel. Resort to extra military instruction (EMI) and the withholding of privileges only after you have counseled the individual and normal instruction and training have failed to accomplish the necessary objective. Use nonpunitive measures for those failing to maintain normal standards, but make sure you acknowledge exemplary behavior and performance when you see it. You are expected to publicly commend your personnel, when appropriate, and take the initiative in rewarding outstanding individuals. Some of the methods you should use are as follows:

- Recommending the awarding of letters of commendation and appreciation
- Recommending personal awards and assignment to training schools
- Recommending deserving personnel for sailor of the month, year, fleet, and so on
- Assigning preferred duties
- Recommending personnel for reenlistment
- Awarding high performance marks.

PETTY OFFICER AUTHORITY

LEARNING OBJECTIVES: Define general authority, organizational authority, and lawful orders. Describe the correct use of extra military instruction (EMI). Explain withholding of privileges, extension of working hours, nonpunitive censure, and alternative voluntary restraint.

One of the most important aspects of your military duties is to correct the substandard military performances of your subordinates without taking them to mast. You must understand the correct use of EMI; the withholding of privileges, and the extension of working hours. These are all elements of supervision that are available to you but must be used in strict compliance with Navy Regulations, orders, and your command's guidance. You do have the authority, as well as the responsibility, to carry out your position in the military chain of command. Do not forget that the principal and most effective means of influencing subordinates' behavior is your strong leadership and example. Corrective measures should never be used to cover up poor leadership on your part. If you have to resort to corrective measures frequently, examine your way of doing business to make sure that you are not a major part of the problem.

If you are given the authority to award EMI outside working hours, you must exercise this authority in a positive, constructive, objective, and evenhanded manner. Your exercise of this authority must not only be fair but must be seen as fair by all the personnel in your command.

AUTHORITY AND RESPONSIBILITY

Authority is tied directly to your duties and responsibilities. The exercise of authority is linked to your acceptance of responsibility and is granted only to support you in carrying out your assigned duties and responsibilities. You have general authority as a petty officer by virtue of your position in the Navy organization, and you have organizational authority by the particular billet you are now holding.

General Authority

Your general authority stems from Article 1110 of Navy Regulations which sets forth the qualities of all officers and petty officers. Article 1020 of Navy Regulations gives you the right to exercise authority

over all persons subordinate to you and the subordinates are charged, in Article 1132, to obey their superiors.

Organizational Authority

Your organizational authority stems from your assignment to a specific billet in a ship or station. Articles 1021 and 1029 of *Navy Regs* give officers, warrant officers, and petty officers necessary authority to perform their duties.

Lawful Orders

All your orders must be lawful. You cannot impose punishment outside the framework of the UCMJ. What has caused some confusion among petty officers is what measures can be taken to correct minor infractions that do not merit punishment under Article 15 of the UCMJ, to correct deficiencies in a phase of military duty in which one of your personnel may be deficient, or to direct completion of work assignments that extend beyond regular working hours. The following paragraphs explain those nonpunitive measures available to you and guide you in preventing the misuse of other corrective measures.

EXTRA MILITARY INSTRUCTION

To establish consistency within the Navy and to remove uncertainty now existing, the following policy is established.

EMI is instruction in a phase of military duty in which an individual is deficient and is intended to correct that deficiency. EMI is an administrative measure authorized under R.C.M. 306(c)(2) and Part V, *Manual of Courts-Martial* (MCM), 1984, as a bona fide training device intended to improve efficiency of a command or unit and must, therefore, be genuinely intended as such. It must not be used as a substitute for punitive action appropriate under the UCMJ. Extra instruction assigned must be logically related to the deficiency to be corrected.

Implementation

EMI within the Navy should be implemented, when required, within the following limitations:

- EMI will not normally be assigned for more than 2 hours per day.
- EMI may be assigned at a reasonable time outside normal working hours.

- EMI will not be conducted over a period that is longer than necessary to correct the performance deficiency.
- EMI should not be assigned on member's sabbath.
- EMI will not be used as a method of depriving normal liberty. A member who is otherwise entitled to liberty may commence normal liberty upon completion of EMI.

Authority

Authority to assign EMI to be performed during working hours is not limited to any particular rank or rate. It is an inherent part of that authority over subordinates that is vested in officers and petty officers in connection with duties and responsibilities assigned to them. Authority to assign EMI to be performed after working hours rests in the CO or OIC but may be delegated to officers and petty officers in connection with duties and responsibilities assigned to them. Administration of EMI within the Navy should be monitored by superiors in the chain of command as part of their normal supervisory duties. Authority should not be delegated below the lowest level of competence. Authority to assign EMI during working hours may be withdrawn by any superior if warranted. Authority to assign EMI after working hours may be withdrawn as provided in delegation of authority of the CO or OIC.

Duties and responsibilities should also be withdrawn if withdrawal of authority is considered appropriate. Delegation of authority to assign EMI outside of working hours to responsible officers and senior petty officers is encouraged. Ordinarily such authority should not be delegated below the chief petty officer level. However, it is emphasized that delegation is the prerogative of the CO and he or she is expected to exercise his or her independent judgment in determining the appropriate level, based on the situation prevailing in his or her command.

WITHHOLDING OF PRIVILEGES

Temporary withholding of privileges is authorized under R.C.M. 306(c)(2) and Part V, MCM, 1984, as another administrative corrective measure that may be employed by superiors to correct infractions of military regulation or performance deficiencies in their subordinates when punitive action does not appear appropriate due to the minor nature of the infraction or

deficiency. A privilege is a benefit, advantage, or favor, provided for the convenience or enjoyment of an individual. Examples of privileges that may be temporarily withheld as administrative corrective measures are special liberty, exchange of duty, special pay, special command programs, base or ship libraries, base or ship movies, base parking, and base special services events.

Final authority to withhold a privilege, however temporary, must ultimately rest with the level of authority empowered to grant that privilege. Therefore, authority of officers and petty officers to withhold privileges is, in many cases, limited to recommendations via the chain of command to the appropriate authority. Officers and petty officers are authorized and expected to initiate such actions when considered appropriate to remedy minor infractions as necessary to further efficiency of the command. Authority to withhold privileges of personnel in a liberty status is vested in the CO or OIC. Such authority may, however, be delegated to the appropriate level, but, in no event, may the withholding of such privileges either by the CO, OIC, or some lower level be tantamount to a deprivation of liberty itself.

EXTENSION OF WORKING HOURS

Deprivation of normal liberty as a punishment except as specifically authorized under the UCMJ is illegal. Therefore, except as the result of punishment imposed by Article 15, UCMJ, or by a court-martial, it is illegal for any officer or petty officer to deny to any subordinate normal liberty or privileges incident thereto as punishment for any offense or malperformance of duty. However, lawful deprivation of normal liberty may result from other actions such as authorized pretrial restraint, or deprivation of normal liberty in a foreign country or in foreign territorial waters, when such action is deemed essential for the protection of the foreign relations of the United States, or as a result of international legal hold restriction. Moreover, it is necessary to the efficiency of the naval service that official functions be performed and that certain work be done in a timely manner. It is, therefore, not a punishment when persons in the naval service are required to remain on board and be physically present outside of normal working hours, or for the accomplishment of additional essential work, or for the achievement of the currently required level of operational readiness. Good leadership and management practice requires that the impact of readiness requirements and work

requirements on normal liberty be kept under continual review. It is expected that supervisory personnel will keep their immediate supervisors informed when they intend to direct their subordinates to work beyond normal working hours.

NONPUNITIVE CENSURE

Nonpunitive censure is nothing more than criticism of a subordinate's behavior or performance of duty by a military superior. This censure is informal and it may be delivered either orally or in writing. Since this form of admonishment is commonly used in military organizations, it is normally delivered orally and referred to as "chewing out." A nonpunitive letter of censure is a more formal method of registering disapproval than some other means of communication, but it is not a matter of record and does not become a part of one's official record. The law places little restraint on the commander's use of this leadership technique though sound leadership principles may dictate the commander's use of censure in terms of good judgment.

ALTERNATIVE VOLUNTARY RESTRAINT

Alternative voluntary restraint is a device whereby a military superior promises not to report an offense or to impose disciplinary punishment for it in return for a promise by the subordinate not to take normal liberty and to remain on base or aboard ship. Such a practice is not recognized as a lawful exercise of military authority and a superior who uses this device runs a risk of prosecution. Alternative voluntary restraint should also be avoided since it cannot be enforced in court should the matter arise in a criminal prosecution.

UNIFORM REGULATIONS

LEARNING OBJECTIVES: State the importance of proper uniform wear. Explain a brief history of Navy uniforms. Describe the classes and types of uniforms and uniform policy when traveling. Explain the uniform regulations in terms of correct wear, care, and special uniform situations. Describe the uniforms for security personnel and shore patrol. Define protective clothing.

The United States Navy is a uniformed military service. Its uniforms and the indications of rank and

specialty displayed thereon are but outward symbols of naval organization and military rank or rating. As such, the Navy uniform is a visibly important element in the morale, pride, discipline, and effectiveness of the Navy. The subject of uniforms and operational attire, therefore, merits concern and individual attention at the senior level in each Navy organization.

HISTORY OF U.S. NAVY UNIFORMS

The development of the naval uniform has both recognized and maintained historical precedent. Since the early days of the United States Navy, there has existed a basic uniform policy directed toward clothing members in attractive, distinctive, and practical uniforms. Naval uniforms have reflected these criteria in their evolutionary development by gradual and meaningful changes in response to existing requirements, contemporary fashions, uniform material improvements, and economics. Uniforms have evolved that enable the sailor to work efficiently within the naval environment, afford some functional protection, and provide a distinct identity. The uniforms selected have been those that adapted to the unique and rigorous life at sea, as well as assignments ashore.

Again, following historical precedent, the establishment of an enlisted uniform distinctive from the officer's uniform has reflected the separate responsibility levels of the first members of the Navy. Through the years, as senior petty officers assumed a greater leadership role, this concept has largely persisted as the tradition of "bell bottoms" remained popular and the American public readily identified U.S. sailors. In his traditional enlisted uniform the American Navy man "looked like a sailor." Those responsible for the development of Navy uniforms have continued the traditional concept as the jumper style enlisted uniform remains practical, adaptable, and, with the addition of rating badges, easily identifiable. Conversely, the officer's and senior petty officer's service uniform paralleled civilian executive attire and was both fashionable and practical. Thus, through the years, distinct uniforms have been accepted and should be maintained.

The action to use a suit style for all enlisted personnel has been one of the most controversial changes to affect the Navy in its uniform history. From a practical standpoint, the adoption of a different uniform for dress wear was not the result of a requirement. The jumper/bell bottom style had evolved in a work environment where each piece of

the garment originally satisfied a need. With the absence of fully rigged sailing ships and the advent of more comfortable work uniforms, what a sailor wears for dress occasions is now a matter of style.

The most obvious impasse to acceptance of the suit and tie outfit to the enlisted and general public is that it breaks with tradition. While the components of the jumper style uniform serve no nautical purpose today and are not related to anything worn in the civilian world, it has served to identify sailors all over the globe for too long a period of time. Most navies of the world have used a similar outfit and most still retain it for nonrated personnel. Throughout the course of uniform history there has continued a strong resistance to changing traditional garments. Sailors prefer to be distinctively dressed. It was the same in 1830s as it is today.

The growing number of women in the Navy, the increasing number of job skills being developed by these women, and the prospect of assigning more women to sea duty has necessitated an examination of the concepts guiding development of women's uniforms. The obvious goal is uniformity; however, it is not desirable to sacrifice femininity to obtain this uniform appearance. Accordingly, the use of modified male uniform components is not desirable. The uniforms for women must combine utility with contemporary fashion ensuring compatibility without frequent change.

CATEGORIZATION OF NAVY UNIFORMS

History and unique conditions of the naval service demand that distinctive uniforms be provided to meet the varied needs of people in the Navy. Distinctions are necessitated by usage requirements and climatic environment.

Classes of Uniforms

Individual uniform needs exist for ceremonial dress, for wear to correspond to a business suit environment, for work, and finally for social functions. These uniforms are categorized and defined as follows:

- Ceremonial. Full dress uniforms are prescribed for official formal occasions that include honors aboard ships and stations, such as changes of command, inspections, and similar ceremonies.

- Protocol (social). Dress uniforms, formal and dinner dress, are prescribed for formal evening functions or state occasions at which civilians normally wear evening dress (white tie) or dinner dress (black tie). Specialized dress uniforms may also be developed and prescribed to meet certain unique protocol requirements.

- Uniform of the day. Service dress uniforms normally are prescribed as the uniform of the day. These uniforms are equivalent to civilian business attire and are prescribed for normal executive office work, watchstanding, liberty, and official business ashore.

- Work. Working uniforms are prescribed for working situations that would unduly soil dress uniforms or where dress uniforms would be inconvenient or unsafe. Working uniforms are prescribed as the uniform of the day aboard ship when at sea and usually are permitted for shipboard personnel in port during normal working hours. They may also be worn at shore stations during normal working hours in industrial areas, and when otherwise deemed appropriate by the senior officer present.

Types of Uniforms

Uniforms must reflect the climate in which they are to be used. Extremes of climate and environment, such as polar wear or flight equipment, are considered to be outside of the prescribed *U.S. Navy Uniform Regulations* and are governed by technical requirements as operational attire. In conformance with civilian convention, there are three seasonal types:

- Winter—Mediumweight garments designed to be worn during winter months of temperate zones (vice arctic wear).

- Summer—Lightweight garments designed to be worn during summer months of temperate zones (vice tropical).

- Tropical—Lightweight garments designed to be worn under tropical conditions.

PRESCRIBING UNIFORM WEAR

To provide optimum uniform control (uniformity), special emphasis is placed on the prescribing of the most suitable uniforms, dress and work, with regard to work environment, local climatic conditions, geographic location, and public exposure.

Pride in appearance is the mark of a responsible military member, officer and enlisted alike, and a prime indicator of morale and discipline in a command. All naval personnel should familiarize themselves with the standards of appearance and are held responsible for making sure their appearance is within those standards while in a duty status.

The CNO area representatives (formerly called commandants), of each area of responsibility (formerly called naval districts) is assigned the responsibility for establishing and controlling uniform policies within the geographical limits of his or her area. The CNO area representative prescribes uniforms for the season, day, or special occasion for all naval personnel (including marines under his or her command) that will provide the greatest uniformity. The CNO area representative, or an individual acting in the area representative's behalf, makes sure that the need for uniformity is stressed within given commands. Uniformity throughout a geographic area, although desirable, should not be a deterrent to individual command mission.

SOPAs in ports and adjacent waters should, insofar as possible, follow the uniforms prescribed by the CNO area representative with regard to liberty parties and members of the command operating ashore. Uniform policy afloat and for shore stations outside the jurisdiction of any naval area should be the responsibility of the senior officer present.

COS and OICs should make sure that uniforms are properly worn and maintained so as not to bring discredit to the command or to the naval service. Personnel at all levels must make sure that their own appearance and that of their subordinates conform to uniform regulations and grooming standards.

Personnel of all naval activities domiciled within the area should wear only those uniforms prescribed for personnel assigned to the area.

Naval personnel should wear the uniform of their respective rank as prescribed by the designated uniform prescribing authority.

The uniform should be worn properly to reflect credit upon the individual, the naval service, and the United States.

Local uniform regulations are punitively enforceable, having the force of a general order, and should be reviewed by a cognizant judge advocate to ensure enforceability.

UNIFORM POLICY

The distinctive Navy uniform is visual evidence of the authority and responsibility vested in the individual by the United States Government. Frequent wearing of the uniform reflects the personal pride of all Navy personnel.

Uniform Requirements

The initial uniforms required by enlisted personnel will be provided at the recruit training centers.

All naval personnel should maintain their full requirement of authorized uniforms and are forbidden to possess or wear any other than the authorized uniform or insignia of their respective grade, corps, or rating or to wear decorations, medals, badges, or their ribbons in any way other than that prescribed. A listing of required uniforms can be found in chapter 7, Table 7-1-1 for enlisted males E-1 through E-6 and chapter 8, Table 8-1-1 for enlisted females E-1 through E-6 of the *U.S. Navy Uniform Regulations*.

Traveling in Uniform

When traveling in uniform on leave, TAD, transfer, and so forth, the service dress blue uniform may be worn during any season of the year. If traveling within a geographic area, either the uniform of the day of the destination area or service dress blue should be worn as the travel uniform. If traveling between geographic areas, either the uniform of the day as prescribed for the destination or service dress blue should be worn as the travel uniform for the entire trip. Working uniforms are not normally authorized for official travel, but area coordinators may authorize working uniforms in specific geographic regions or situations when warranted by local conditions.

GOVERNMENT TRANSPORTATION.— Navy personnel in a duty, leave, or liberty status will wear an appropriate uniform when traveling in any DOD owned or controlled aircraft unless civilian attire is authorized due to local extenuating circumstances for political or personal safety reasons or as required by the USAF *Foreign Clearance Guide*. This policy applies to personnel traveling on military and Military Airlift Command (MAC) contracted (Category B) civil aircraft departing from military airfields and commercial gateways.

COMMERCIAL TRANSPORTATION.— When traveling on commercial international flights,

Navy personnel in a duty, leave, or liberty status will wear an appropriate uniform or civilian clothing as required by the USAF Foreign Clearance Guide. For travel in the United States, Navy personnel using a commercial mode of transportation may wear an appropriate uniform or civilian clothing.

COMMUTING.— The prescribing authority may authorize working uniforms for commuting to and from work. Commuting is defined as a direct route from place of residence to place of work by means of a private vehicle. No stops are authorized when commuting in a working uniform.

UNIFORM LAWS, REGULATIONS, AND DIRECTIVES

The wearing of the uniform by members of the naval service is governed by various laws, regulations, and amplifying directives issued by competent authority. Applicable laws may be found in the U.S. *Navy Uniform Regulations*. Those regulations that are governed by Navy Regulations have been previously mentioned in this chapter.

CARE OF THE UNIFORM

The longest service of the various articles of the prescribed uniform can be obtained only by proper care and maintenance. No matter how well-fitting a uniform is when new, especially the coat, it will not continue to look its best or keep its shape unless it is carefully put on and kept buttoned. The carrying of large or heavy objects in the pockets will destroy the shape of the best uniform. Uniforms should always be kept on hangers when not in use. If uniforms are to be put away for a long time and left undisturbed, thoroughly clean, then pack away in an airtight plastic bag with a packet of desiccant (drying agent) enclosed to afford maximum protection.

The basic guideline in caring for the uniform is to keep the cloth clean. Dirt accelerates the rate of wear. Accordingly, prompt removal of spots and frequent washing and dry cleaning are recommended. In view of the use of synthetic fibers in some uniform articles, consult a professional cleaner before attempting to wash or clean any garments, if unfamiliar with the cloth.

Uniform Stencils

Articles of clothing should be legibly marked with the owner's name and service number, using black

marking fluid for marking white clothes and chambray and utility blue shirts, and white marking fluid for marking blue clothes and dungaree trousers, or with indelible ink when labels are provided for the purpose. Markings should be made with a 1/2-inch stencil, stamp, or suitable black and white embroidery. If garment labels are provided, the name and service number should be legibly printed thereon. For male and female personnel E-1 - E-6, required articles of clothing and accessories should be marked according to *U.S. Navy Uniform Regulations*.

Transfer of Uniforms

No transfer or exchange of uniform clothing or enlisted personnel should be made without the authority of the CO.

Government-owned Uniforms

Government-owned clothing will be stenciled with the letters USN. In addition, to facilitate identification, a brief stenciled marking (letter, numeral, or combination of both) may be appended to the basic marking.

Organizational Clothing

Organizational clothing is any clothing that is issued to an individual by a naval activity on a loan basis and, therefore, remains the property of the Navy and is returned to the activity when the individual is transferred. Organizational clothing issued to personnel may be worn as required by prescribing authorities for specific work situations only.

CORRECT WEAR OF THE UNIFORM

As an MA, you will be most concerned with the general regulations for the correct wearing of clothing articles. A full listing of articles is found in chapters 3 through 8 of the *U.S. Navy Uniform Regulations*.

SPECIAL UNIFORM SITUATIONS

Special uniform situations occur frequently throughout fleet units. As an MA endeavoring to enforce uniform regulations, you must be familiar with the regulations governing these special situations. The following are two examples of special uniform situations.

Reflectorized Materials

Reflectorized materials may be applied to the uniform and furnishings for night visibility when prescribed by competent authority.

Naval Personnel on Duty With Other Services

Naval personnel on duty with Army or Air Force organizations should wear naval uniforms appropriate to those prescribed for personnel of the service concerned. Refer to chapters 10 and 11 of the

U.S. Navy Uniform Regulations for more information on special uniform situations.

UNIFORMS FOR SECURITY PERSONNEL

For male and female enlisted personnel performing duties as base police, corrections personnel, guard personnel, or MAs, the winter blue, summer white, or camouflage uniforms are worn (fig. 1-1). MAs afloat uniforms are determined by local commands.

Only authorized outer garments such as peacoats, reefers, raincoats, and windbreakers should be worn

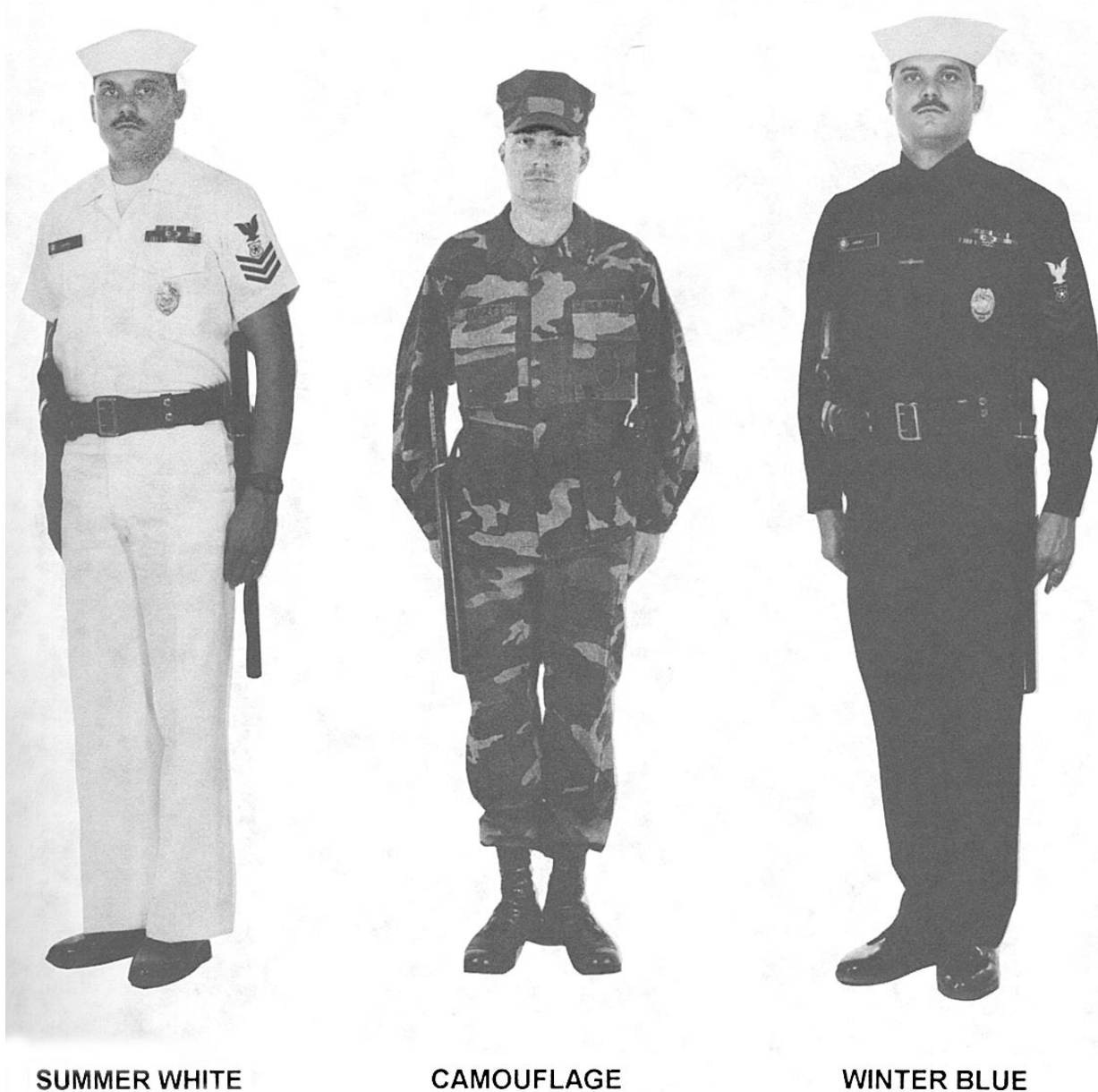

Figure 1-1.—Uniforms for security personnel

193.127

with the appropriate uniforms. For further guidance in the authorized outer garments and the correct wearing of the uniform, refer to chapters 7,8, and 11 of the U.S. Navy Uniform Regulations.

Badges

MAA/law enforcement badges will be worn by all military personnel who are assigned to an official MAA/law enforcement/physical security or corrections position.

CORRECT WEAR (MEN).— Wear on the left side. The badge may be worn on all uniforms except formal

and dinner dress. This badge may be worn only during the period of detail. See figure 1-2.

The badge should be worn as follows:

- On pockets with flaps, center the badge between the lower point of the flap and bottom of the pocket, midway between the sides.
- On pockets without flaps, center the badge on the pocket.
- On full dress uniforms, center the identification badge on the left pocket one-fourth inch below the lowest row of medals or below the second breast

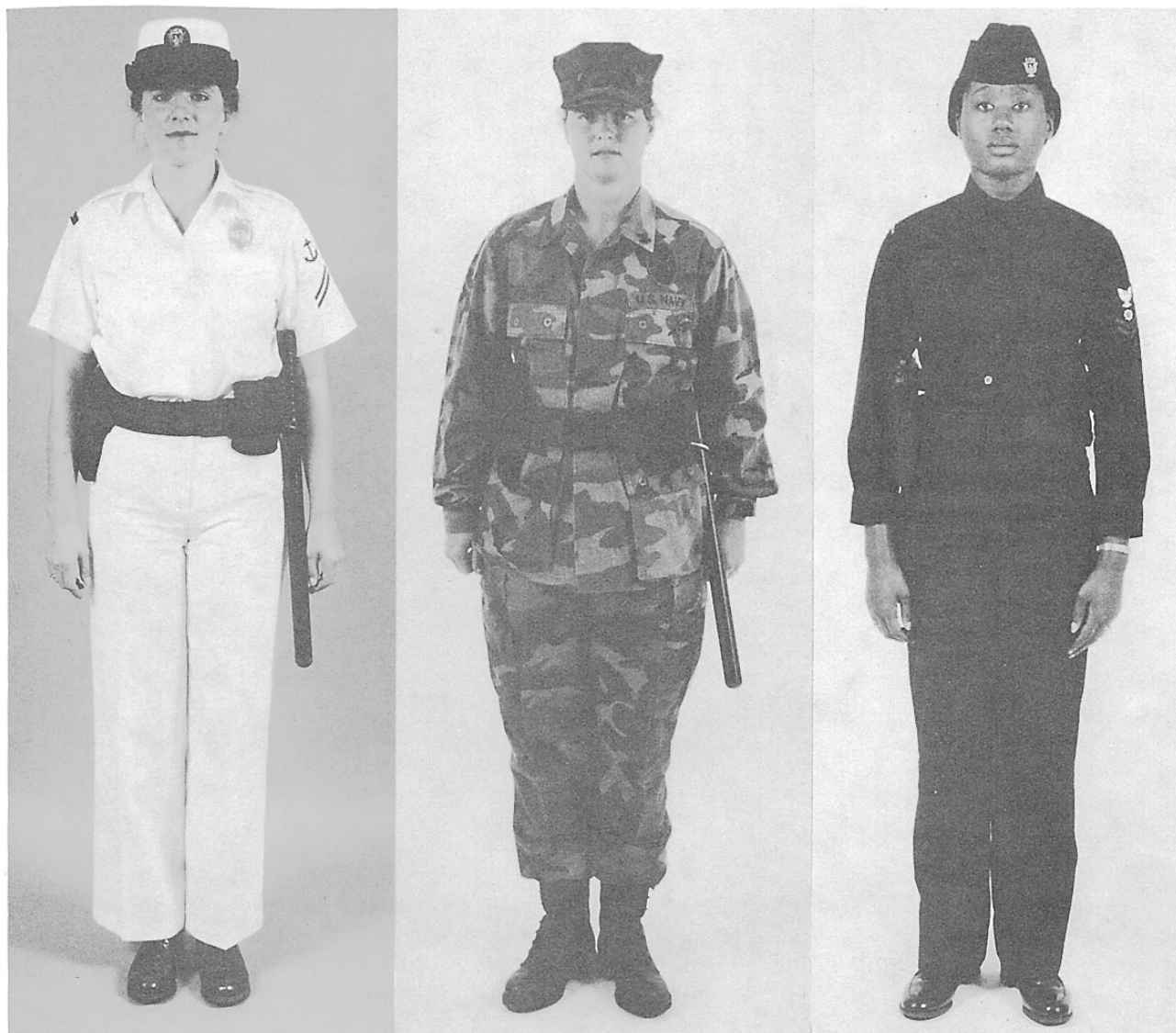

SUMMER WHITE

CAMOUFLAGE

WINTER BLUE

193.127.1

Figure 1-1.—Uniforms for security personnel—Continued.

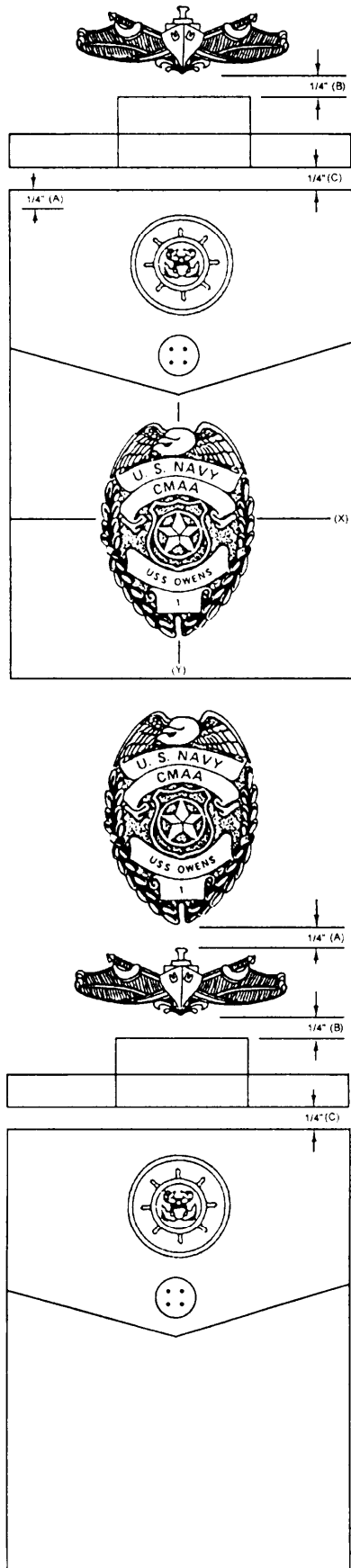

Figure 1-2.—Correct wearing of badges.

insignia, if authorized. If breast insignia, medals and identification badge combined cause the identification badge to be positioned on or below the lower seam of the pocket, do not wear the secondary breast insignia.

CORRECT WEAR (WOMEN).— Wear on the left side. Center the badge one-fourth inch above the coat/shirt pocket or above authorized ribbons/breast insignia. See figure 1-2.

A standard size badge is available through the supply system and is the only authorized one to be used. See figure 1-3.

MAA/LAW ENFORCEMENT BADGES



GOLD

SILVER

GOLD OR SILVER

GOLD OR SILVER

GOLD OR SILVER

Figure 1-3.—MAA/law enforcement badges.

Shore Patrol

Personnel assigned to perform shore patrol (SP) duties should wear the uniform of the day, with pistol belt, SP brassard, policeman's baton, and such other crowd control equipment as designated by competent authority. (See fig. 1-4.) The brassards should be worn on outer garments on the right arm midway between the shoulder and elbow. A white helmet liner may be authorized by the senior officer present.

Protective Clothing

Naval personnel are authorized to wear protective clothing with the uniform only while operating or riding as a passenger on any two- or three-wheeled vehicle or while proceeding to and

from the parking area to the duty station. Protective clothing means clothing that would prevent or lessen injury, especially to the skin, in the event of an accident. Protective clothing includes helmet (headgear), boots or heavy shoes, leather jacket, and leather gloves.

Boots or heavy shoes, if worn instead of uniform shoes, will be of plain design. The jacket will be plain leather or a material equal in protective qualities, unadorned except for safety markings. Leather gloves or other suitably protective gloves are authorized.

The procurement of protective clothing is the responsibility of the individual. Stowage of this clothing on board ship will be dependent upon availability of space and will be at the discretion of the commanding officer.

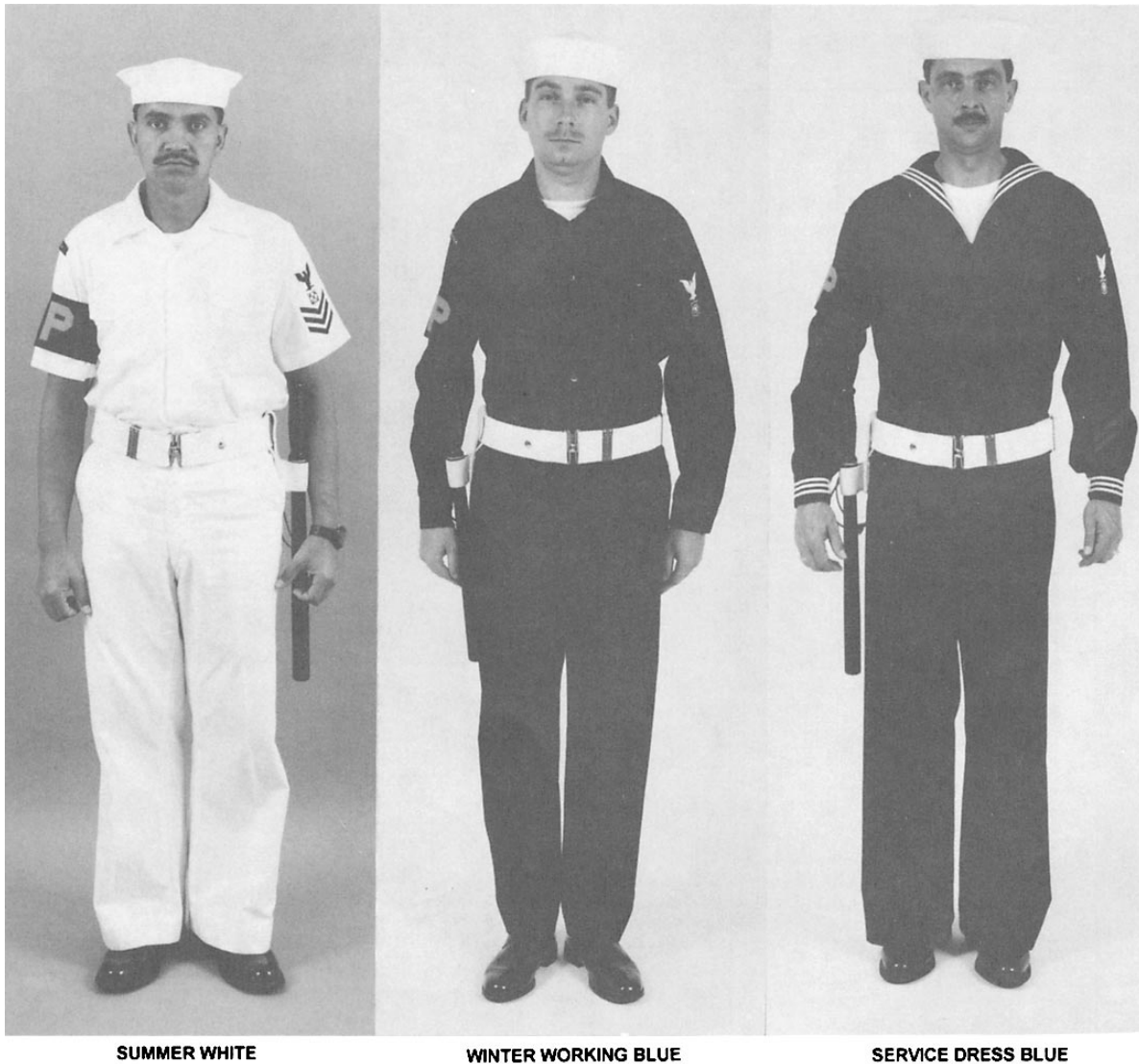

Figure 1-4.—Shore patrol uniforms.

193.127.2

GROOMING STANDARDS

LEARNING OBJECTIVES: Explain the personal grooming standards for men and women. Discuss the importance of smartness when wearing the uniform. Explain the uniform policy for glasses, undergarments, and civilian clothing.

Grooming standards are based on several elements including neatness, cleanliness, safety, military image, and appearance. The standards established here are not intended to be overly restrictive nor are they designed to isolate Navy personnel from society. The limits set forth are reasonable, enforceable, and make sure that personal appearance contributes to a favorable military image. The difference between men's and women's grooming

policies recognizes the difference between the sexes; sideburns for men, different hairstyles and cosmetics for women. Establishing identical grooming and personal appearance standards for men and women would not be in the Navy's best interest and is not a factor in the assurance of equal opportunity. The primary consideration is to have a neatly groomed appearance while wearing naval uniforms.

PERSONAL APPEARANCE (MEN)

Men should be well groomed at all times and meet the following minimum standards.

Hair

Keep hair neat, clean, and well groomed. Hair above the ears and around the neck should be tapered



Figure 1-4.—Shore patrol uniforms—Continued.

193.127.3

from the lower natural hairline upwards at least three-fourth inch and outward not greater than three-fourth inch to blend with hairstyle. Hair on the back of the neck must not touch the collar. Hair should be no longer than 4 inches and may not touch the ears, collar, extend below eyebrows when headgear is removed, show under front edge of headgear, or interfere with properly wearing military headgear. The bulk of the hair should not exceed 2 inches. Bulk is defined as the distance that the mass of hair protrudes from the scalp. Hair coloring must look natural and complement the individual. Faddish styles and outrageous multicolored hair are not authorized. The unique quality and texture of curled, kinked, waved, and straight hair are recognized, and in some cases the 3/4-inch taper at the back of the neck may be difficult to attain. In those cases hair must present a graduated appearance and may combine the taper with a line at the back of the neck. One (cut, clipped or shaved) natural narrow part is authorized. Varying hairstyles, including afro, are permitted if these styles meet the criteria of maximum length and bulk, tapered neck and sides, and do not interfere with properly wearing military headgear. Plaited or braided hair should not be worn while in uniform or in a duty status.

Sideburns

Keep sideburns neatly trimmed and tailored in the same manner as the haircut. Sideburns should not extend below the bottom of the earlobe, should be of even width (not flared), and should end with a clean-shaven horizontal line. See figure 1-5. Mutton-chops, ship's captain, or similar grooming styles are not authorized.

Beards and Mustaches

Mustaches are permitted but the face must be clean-shaven. A mustache will be kept neatly and closely trimmed. No portion of the mustache should extend below the lip line of the upper lip. In addition, it will not go beyond a horizontal line extending across the comers of the mouth and no more than one-fourth inch beyond a vertical line drawn from the corner of the mouth. The length of an individual mustache hair fully extended will not exceed one-half inch. See figure 1-5. Handlebar mustaches, goatees, beards, or eccentricities are not permitted. A beard may be worn for health reasons when authorized by a commander/CO on the advice of a medical officer. If a waiver is authorized, facial hair will be kept trimmed not to exceed one-fourth inch in length. Individuals

granted a shaving waiver will not shave any facial hair. Commanders/COs should monitor progress of treatment to control these waivers. Except for persons with valid medical reasons for not shaving, the following personnel are not authorized to wear any facial hair:

- Brig prisoners.
- Brig awardees.
- Personnel in a disciplinary hold status (that is, those who are serving restriction or hard labor without confinement or extra duties as a result of a court-martial or NJP).
- Personnel assigned to a transient personnel unit who are awaiting separation for the following three reasons:

By reason of a court-martial sentence

To benefit the service (MILPERSMAN 3630900)

Pursuant to the recommendation or waiver of an administrative discharge board, for misconduct (MILPERSMAN 3630600)

Refer to figure 1-5. Sideburns should not extend below the earlobes as indicated by line A. When a mustache is authorized, it should not go below a horizontal line extending across the corner of the mouth as indicated by line B. The mustache should not extend more than one-fourth inch beyond a vertical line drawn upward from the corners of the mouth as indicated by line C and should not protrude below the upper lip as indicated by line D. Hair should not be greater than 2 inches in bulk which is the distance the mass of hair protrudes from the scalp. Hair should not be more than 4 inches in length.

Hairpieces

Wigs or hairpieces may be worn by active duty personnel while in uniform or duty status only for cosmetic reasons to cover natural baldness or physical disfigurement. Wigs may be worn by Naval Reserve personnel engaged in inactive duty for training. Wigs or hairpieces will be of good quality and fit, present a natural appearance, and conform to the grooming standards set forth in these regulations. They will not interfere with the proper performance of duty, or present a safety or FOD (foreign object damage) hazard.

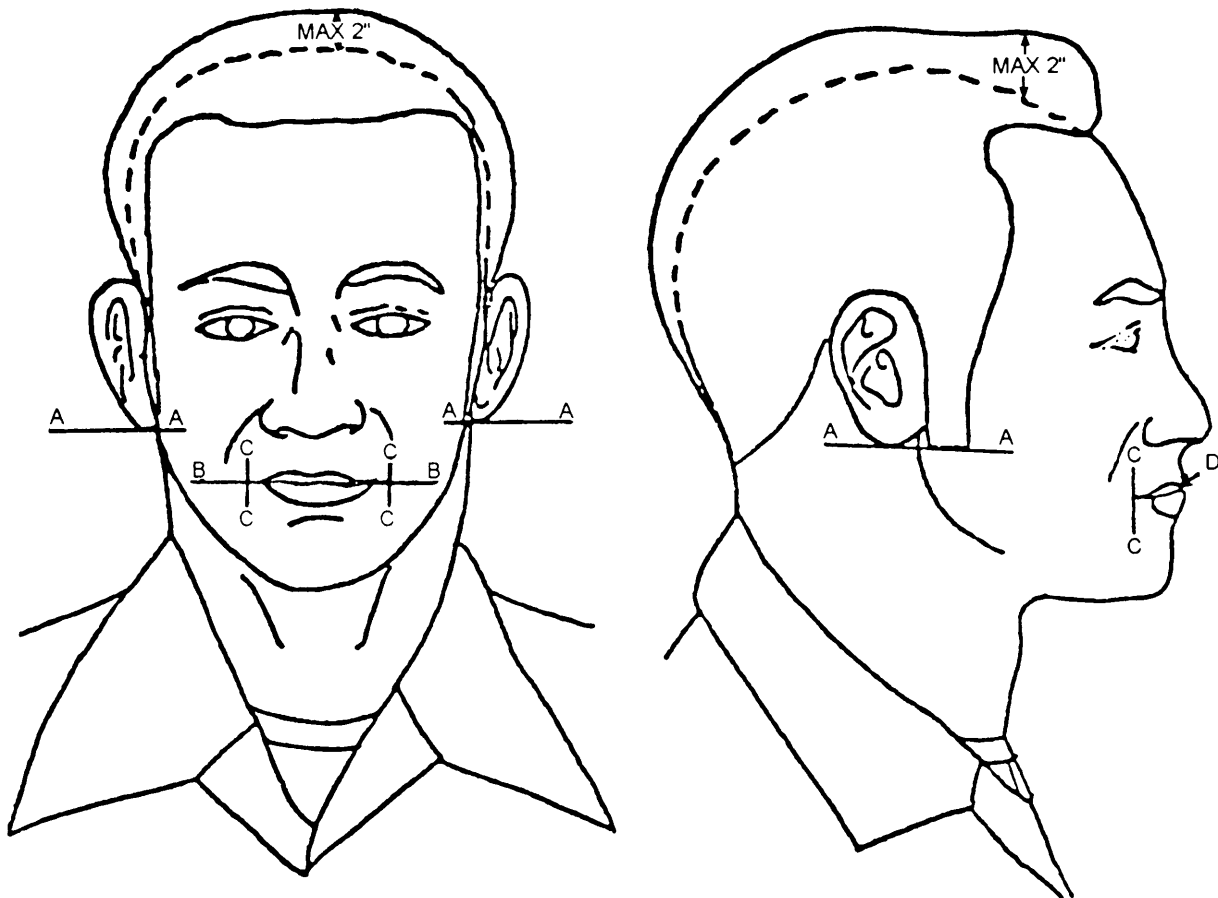

Figure 1-5.—Male hair grooming standards.

Fingernails

Fingernails will not extend past fingertips.

Jewelry

Jewelry is authorized for all male personnel and should be in good taste while you are in uniform. Eccentricities or faddishness is not permitted. Jewelry should not present a safety or FOD hazard. Jewelry should be worn within the following guidelines.

RINGS.— While in uniform, only one ring per hand is authorized, plus a wedding ring.

EARRINGS.— While in uniform, not authorized. Additionally, earrings are not authorized with civilian attire when in a duty status or while aboard any ship, craft, aircraft, or in any military jurisdiction, or within any base or other place under military jurisdiction, or while participating in any organized military

recreational activities. No other articles should be attached to or through the ear or nose.

NECKLACES/CHOKERS.— While in uniform, only one necklace may be worn and it should not be visible.

WRISTWATCHES/BRACELETS.— While in uniform, only one of each may be worn. Ankle bracelets are not authorized while in uniform.

PERSONAL APPEARANCE (WOMEN)

Women should be well groomed at all times and meet the following minimum standards.

Hair

Keep hair clean, neatly shaped, and arranged in an attractive feminine and professional style. Hairstyles with a maximum of two braids may be worn. Faddish and exaggerated styles are prohibited. Ponytails and

pigtails are not permitted. When in uniform, hair on back of the head may touch but not fall below the lower edge of the collar. When wearing jumper uniforms, hair can extend a maximum of 1 1/2 inches below the top of the collar. Long hair, including braids, must be neatly and inconspicuously fastened, pinned, or secured to the head presenting an attractive hairstyle and may not dangle free at any point. See figure 1-6. Hair must not show under the front of the brim of the combination hat, garrison cap, or command ball cap. Afro, natural, bouffant, and other similar hairstyles, which do not interfere with proper wearing of headgear, are permitted. The bulk of the hair should not exceed 2 inches. Bulk is defined as the distance the mass of the hair protrudes from the scalp. Hair coloring must look natural and complement the individual. Faddish and outrageous multicolored hair is not authorized. Visible hairnets may be worn only

if authorized for specific duties such as hospitals or galleys.

Hair should not fall below the lower edge of the back of the collar as indicated by line A. When wearing jumper uniforms, hair can extend a maximum of 1 1/2 inches below the top of the collar.

HAIR ORNAMENTS.— Conspicuous rubber bands, combs, and pins are not authorized. When worn, hair ornaments should not present a safety or FOD hazard. A maximum of two barrettes, similar to hair color, may be used to pin up hair.

HAIRPIECES.— While in uniform or duty status, hairpieces or wigs should be of good quality and fit, present a natural appearance, and conform to the grooming standards set forth in these regulations. They should not interfere with the proper performance of duty, or present a safety or FOD hazard.



Figure 1-6.—Female hair grooming standards.

Cosmetics

Cosmetics should be applied in good taste so that colors blend with natural skin tone and enhance natural features. Exaggerated or faddish cosmetic styles are inappropriate with the uniform and should not be worn. Care should be taken to avoid an artificial appearance. Lipstick colors should be conservative and complement the individual. Long false eyelashes should not be worn when in uniform.

Fingernails

Fingernails should not exceed one-fourth inch measured from the fingertip. Nail polish colors should complement the skin tone,

Jewelry

Jewelry is authorized for all female personnel and should be in good taste while you are in uniform. Eccentricities or faddishness are not permitted. Jewelry should not present a safety or FOD hazard. Jewelry should be worn within the following guidelines.

RINGS.— While in uniform, only one ring per hand is authorized, plus an engagement ring (or wedding ring set).

EARRINGS.— One earring per ear (centered on earlobe) may be worn with any uniform. Nose rings are not authorized. Earrings should be 6mm ball (approximately one-fourth inch), plain with brushed matte finish, screw-on or with posts. Gold for officers/CPOs, and silver for enlisted personnel. Small single pearl earrings are authorized for wear with dinner and formal dress uniforms.

NECKLACES/CHOKERS.— While in uniform, only one necklace may be worn and it should not be visible.

WRISTWATCHES/BRACELETS.— While in uniform, only one of each may be worn. Ankle bracelets are not authorized while in uniform.

SMARTNESS

United States Navy personnel must set and maintain the high standards of smartness in uniform appearance. The military image reflected by attention to detail is a key element in the public image of the Navy. Uniforms should be kept scrupulously clean,

with lace, devices, and insignia bright and free from tarnish and corrosion.

No articles, such as pencils, pens, watch chains, key chain fobs, pins, jewelry, handkerchiefs, combs, large wallets, cigars, cigarettes, pipes, or similar items, should protrude from or be visible on the uniform. Jewelry, tie clasps, cuff links, shirt studs, and earrings should be worn as prescribed elsewhere in these regulations.

GLASSES

The following is guidance for wearing of eyewear.

- Prescription glasses—No eccentric or faddish glasses are permitted. Retainer straps are not authorized except for safety or FOD prevention.

- Sunglasses—Conservative sunglasses are permitted, except in military formations. Retainer straps are not authorized except for safety or FOD prevention.

- Contact lenses—Tinted contact lenses must be a natural color (blue, green, brown).

UNDERGARMENTS

Appropriate undergarments will be worn to preserve the dignity and appearance of the uniform.

CIVILIAN CLOTHING

Officers and enlisted personnel are permitted to have civilian clothing in their possession at naval activities ashore when authorized by the prescribing authority. Personnel aboard ship may have civilian clothing when authorized by the CO. Such clothing may be authorized for wear while leaving or returning to ships or stations, while awaiting transportation after permission to leave the ship has been given, while on authorized leave of absence, liberty, or in any off-duty status ashore. Commands are authorized to suspend the privilege of wearing civilian clothing for individuals who do not wear civilian clothing as outlined in this section, or who fail to maintain adequate uniforms properly. Regional commanders and the senior officers present may suspend the privilege of wearing civilian clothing to meet local conditions.

CASUAL CIVILIAN ATTIRE

Naval personnel should make sure that their dress and personal appearance are appropriate for the

occasion and will not discredit the Navy. Current styles and fashions are authorized.

Tank-top shirts, white undershirts worn as outer garments, cutoff shorts, and shower sandals are appropriate civilian attire for occasions such as picnics, athletic events, and other casual daytime activities, otherwise these items are not acceptable within the confines of a military installation.

WEARING UNIFORM ARTICLES WITH CIVILIAN CLOTHES

Military personnel may wear the following military uniform articles with civilian clothing:

Command ball cap

Belts with/civilian buckles

Four-in-hand necktie

Gloves

Socks/hosiery

Shoes

Underwear

All-weather coat/raincoat without insignia

Windbreaker without insignia

Sweaters (cardigan and blue pullover (government issue))

Watch cap

Purse

DRUG ADVOCATION PROHIBITED

Wearing or displaying clothing, jewelry, tattoos, and so forth, depicting marijuana or any other

controlled substance, or advocating drug abuse is prohibited at all times on any military installation or under any circumstance that is likely to discredit the Navy.

CIVILIAN CLOTHES IN FOREIGN COUNTRIES

Naval personnel stationed overseas or on liberty are authorized to wear civilian clothing under the following conditions. Additionally, when considered appropriate by the prescribing authority under Article 12201.2 of the *Navy Uniform Regulations*, earrings may be prohibited while in foreign countries.

- If the laws of a country prohibit wearing foreign uniforms, civilian clothing must be worn.

- Personnel traveling in a foreign country may wear civilian clothes, but wearing civilian clothes should not conflict with Article 1301.6 of the *U.S. Navy Uniform Regulations*. Prescribing authorities are responsible for setting civilian clothes guidelines appropriate for foreign countries.

SUMMARY

In this chapter we studied the rules and regulations governing the Navy. We discussed U.S. Navy Regulations in terms of purpose, rights, and responsibilities. Some of the general regulations in the *Standard Organization and Regulations of the U.S. Navy* (SORM) were listed. Leadership and petty officer authority were also examined. We looked at the *U.S. Navy Uniform Regulations* for both men and women. Types and classes of uniforms were discussed as well as care, special situations, and uniforms for security personnel. Finally grooming standards for both men and women were covered.

CHAPTER 2

LEGAL ASPECTS OF MILITARY LAW

In civilian life, criminal law seeks to protect society from the ravages of its irresponsible members. It seeks to provide this protection without hasty, ill-considered actions that show prejudice toward any person's fundamental rights. However, military law must not only restrain individuals for the protection of military society but also be an instrument that encourages teamwork and morale. For these reasons, certain acts that are considered inalienable rights in civilian society are offenses in military society. For instance, "telling off the boss" is a right of an American civilian; but in the military service, it may well constitute an offense punishable by court-martial.

Military law also promotes discipline in the Armed Forces. Discipline is that attribute of a military organization that enables it to function in a coordinated manner under different circumstances. Many factors contribute to the building of a well-disciplined organization. One of the more important factors is military law.

Traditional military law has always applied standards of behavior to the Armed Forces that were different and more strict than those applied to civilians. However, the role of the military in protecting our nation justifies the requirement for strict standards of behavior. With that in mind, Congress established a system of military justice for all members of the armed forces. This system is the Uniform Code of Military Justice (UCMJ).

A court-martial has jurisdiction over those offenses described in the UCMJ's punitive articles, Articles 77-134. Many of these articles describe conduct that is purely military in nature, such as unauthorized absence and misbehavior of a sentinel. However, many of the other articles define offenses that are also prohibited in any society, such as murder, theft, and rape.

You are responsible for keeping your knowledge of military law up-to-date; as an MA, you must be thoroughly familiar with the essentials of military law. Now let's look more at the concept of jurisdiction in military law,

JURISDICTION

LEARNING OBJECTIVES: Identify and explain two sources of jurisdiction. Describe jurisdiction over the person, the offense, and the location or place.

All personnel performing law enforcement work for the Navy in the continental United States or overseas need a basic understanding of the legal concepts of *jurisdiction* and *authority to apprehend*. Both of these areas are complex legal subjects, susceptible to change by legislation or court decision. Personnel with specific legal and policy questions should be referred to the local staff judge advocate for guidance and resolution.

Jurisdiction is defined in the judicial sense as the power of a court, military or civilian, to consider a controversy and render a valid judgment. To have such power, a court must have jurisdiction over several areas. But first, let's look at the sources of law that govern jurisdiction.

SOURCES OF JURISDICTION

The sources of federal court jurisdiction are the Constitution of the United States and various federal statutes.

The Constitution

The power of a court-martial to try service persons is contained in Article I, Section 8 of the Constitution, which gives Congress authority to make rules and regulations for the Armed Forces. Article II of the Constitution makes the President of the United States the Commander in Chief of the Armed Forces. The Congress has exercised its rule-making power by enacting the *UCMJ*: Title 10, U.S. Code, Sections 801-940. And the President has exercised his constitutional power by issuing the *Manual for Courts-martial (MCM)*. Both the *UCMJ* and the *MCM* discuss and define court-martial jurisdiction.

The federal statutes of the United States, as well as the Constitution, are sources of jurisdiction. Article III of the Constitution established the United States Supreme Court and also authorized the Congress, by federal statutes, to establish the lower courts. Magistrate and district courts are established under federal statutes. Military law-enforcement officials will often come into contact with civilian violators of federal law. Now let's look at jurisdiction over the person, the offense, and the location or place.

JURISDICTION OVER THE PERSON

To try a person, a court must have authority "over his person." Courts-martial normally have no authority, or power, over civilians. Thus a court-martial could not try a civilian, even though his or her conduct might have been criminal and directly detrimental to the military.

JURISDICTION OVER THE OFFENSE

To try a person for an offense, a court must have jurisdiction over the offense. All courts are limited in the classes of offenses that they may hear and decide. For example, a federal or state civilian court has no authority to try a military person for unauthorized absence from his or her unit. That offense, punishable under Article 86 of the *UCMJ*, can only be adjudicated by the military.

JURISDICTION OVER LOCATION OR PLACE

The jurisdiction of the courts is also limited by the location or place of the offense. For example, the courts of New York State have no jurisdiction to consider cases involving criminal conduct in the state of Florida. Similarly, the United States federal civilian courts have no jurisdiction, generally, to try American citizens for offenses committed in another country. Nevertheless, under Article 5 of the *UCMJ*, a court-martial has jurisdiction to try military personnel for service-connected offenses occurring in "all places."

LEARNING OBJECTIVES: Explain military and civilian jurisdiction and how the service connection issue relates to jurisdiction. Describe jurisdiction as it relates to federal offenses, Explain investigative jurisdiction and how the Federal Assimilative Crimes Act affects jurisdiction. Define territorial, maritime waterway, and security zone jurisdiction, Explain the *Posse Comitatus Act*.

As an MA, you must be concerned with the various types of jurisdiction. To begin with, jurisdiction deals with the type of offense, where it was committed, and by whom it was committed. Many other factors also govern jurisdiction, as you will see in the following discussion.

MILITARY JURISDICTION

Courts-martial have jurisdiction to try only certain specific classes of personnel as delineated in Article 2 of the *UCMJ*. The following describes these classes:

Service members on active duty. Article 2(1) of the *UCMJ* identifies certain active-duty personnel as subject to its jurisdiction.

- Reserve members attending drill. Reservists on inactive duty training, usually weekend drills, are subject to *UCMJ* jurisdiction during drill periods if the orders assigning them to duty so state. The orders of reservists in some branches of the service do not state that the drilling reservist is subject to *UCMJ* jurisdiction. Specific situations should be referred to a local JAG officer.

- Retired persons. Retired members of a Regular component of the armed forces who are entitled to pay, retired members of the Reserves who are hospitalized by the service, and members of the Fleet Reserve or the Marine Corps Reserve are all subject to *UCMJ*. This rule continues military jurisdiction over specified categories of retired service members who retain financial or other ties to the armed forces.

CIVILIAN JURISDICTION

The Supreme Court has ruled that civilians are not under court-martial jurisdiction in peacetime despite *UCMJ*, Article 2(11). That article provides for jurisdiction over "persons serving with, employed by, or accompanying the armed forces outside the United

States.” Our Government has allowed the trial of civilians under military jurisdiction in time of war. However, the United States Court of Military Appeals has interpreted the term *war* to include only a war declared by Congress.

SERVICE-CONNECTION ISSUE

Law-enforcement personnel may encounter some offenses that are not purely military crimes. When that happens, they must evaluate the offense to show a connection between the crime and the military service. If they find no “service-connection,” the military has no jurisdiction, even if the offender is on active duty in the military. Offenses that are not service connected are legal issues that must be referred to the staff judge advocate on a case-by-case basis. The more closely related the crime is to the base, military authority, or military duties, the more apt the courts are to find it a service-connection issue and thus under military jurisdiction.

This service-connection jurisdiction problem does not exist when the crime is committed aboard ship or overseas. In addition, even if no court-martial jurisdiction exists because of a lack of service connection, the crime may still be under the jurisdiction of nonjudicial punishment or of local, federal, or state civilian courts.

JURISDICTION OVER FEDERAL OFFENSES

Title 18 of the United States Code delineates the majority of federal crimes. These crimes are generally major felonies. They apply to both civilians and military personnel and are prosecuted in the federal district courts. Offenses prohibited involve a wide range of serious activities, such as mail fraud, kidnapping, and theft of U.S. property.

INVESTIGATIVE JURISDICTION

Base commanding officers, in addition to having the duty of maintaining good order and discipline, have the responsibility of ensuring that neither military nor civilian personnel on base violate federal civilian laws. The Secretary of Defense and the U.S. Attorney General recognize that certain offenses against federal civilian law are also violations against military law. They recognize that the military offender should be prosecuted by a military tribunal after the military investigation. They also recognize that other offenses committed by military personnel or civilians

should be investigated by other federal agencies and prosecuted in federal criminal courts. The *Manual for Courts-Martial*, appendix 3, details investigative jurisdiction. Now let’s look at investigative jurisdiction for major crimes and for minor crimes and traffic offenses.

Major Crimes

The Federal Bureau of Investigation is the chief investigative agency tasked with the enforcement of federal criminal laws. Other agencies, such as the Drug Enforcement Administration and the Treasury Department, have investigative jurisdiction over specific crimes. Incidents of actual, suspected, or alleged major criminal offenses should be referred to the Naval Criminal Investigative Service (NCIS), which will decide whether the case should be referred to outside federal agencies. If the federal agency does not assume investigative jurisdiction, NCIS will, in most instances, conduct the investigation.

Minor Crimes and Traffic Offenses

The majority of naval commands have investigative personnel within their security departments. Such persons are normally limited to investigating minor offenses. Any major criminal offense should be referred immediately to the NCIS. This requirement of referral does not in any way restrict command law enforcement personnel from executing appropriate procedures. Appropriate procedures include preventing the escape or loss of identity of offenders, preserving crime scenes and the integrity of physical evidence, or conducting on-scene inquiries as appropriate.

Minor offenses include most misdemeanors and traffic offenses. Both the commanding officer (if the subject is military) and the U.S. magistrates may dispose of these offenses. If criminal prosecution before a U.S. magistrate is appropriate, it is effected by the issuance of a U.S. magistrate’s court violation notice, as set forth in SECNAVINST 5822.1.

ASSIMILATIVE CRIMES ACT

To avoid the task of maintaining a complete code of civilian criminal laws for military bases and other federal property, Congress passed the Assimilative Crimes Act. This statute provides that all acts or omissions occurring in an area under federal jurisdiction that would constitute crimes if the area were under state jurisdiction will constitute the same

crimes, similarly punishable, under federal law. For example, Congress has not enacted a traffic code for military bases. However, speeding on a naval base could be a federal traffic violation, because military bases adopt for federal use the traffic laws of the state in which they are located.

TERRITORIAL JURISDICTION

Military reservations generally are categorized as having either exclusive federal jurisdiction or concurrent federal jurisdiction. The federal government may also hold territory in a status of proprietary interest. Jurisdiction in this context refers to the authority to enact and enforce general criminal laws within a given area. Two or three types of jurisdiction may exist within the same installation. Because parts of a base might have been acquired at different times in different ways, one portion might be under exclusive jurisdiction and the next under concurrent. Law enforcement personnel should consult with their local staff judge advocate concerning the jurisdictional status of all portions of their base. Now let's look at exclusive, concurrent, and proprietary jurisdiction.

Exclusive Federal Jurisdiction

Only the federal government has the power to make and enforce federal laws. Federal laws are enforced through various agencies, including the military. Thus, exclusive federal jurisdiction applies only to areas governed by the specific federal criminal statutes and the statutes of the federal Assimilative Crimes Act. Generally, state laws have neither force nor effect in areas of federal jurisdiction; and local, state, or municipal law enforcement authorities have no authority in such areas.

Concurrent Federal Jurisdiction

Both the federal government and state government (including its county and municipal subdivisions) have authority to make and enforce general municipal laws on the land in question. Thus, a single act could constitute a crime against both the federal and local state law. Both naval authorities and state authorities could, in theory, enforce and prosecute under their respective law. However, they must first seek permission as specified in section 0116 of the *Manual of the Judge Advocate General (JAGMAN)*.

Proprietary Jurisdiction

When the federal government has acquired a degree of ownership of a piece of property but has not obtained legislative authority over the area, generally only the state has the power to enforce its laws on the property. The United States has the right, however, as does any landowner or tenant, to protect its property. In addition, state authorities cannot interfere with any valid military activity on such property.

A court-martial has jurisdiction over a military member on active duty no matter where the offense is committed; however, coordination between naval and state/local authorities is always recommended first.

MARITIME WATERWAY AND SECURITY ZONE JURISDICTION

The United States Coast Guard has the ultimate responsibility for law enforcement jurisdiction for intercostal waterways and in security zones. The Coast Guard will board all vessels making an unauthorized entry into any security zone and make any apprehensions required.

Although the Coast Guard is responsible for security on the waterways, commands are not relieved from their primary responsibility for the protection and security of waterfront facilities.

Further guidance can be found in *Combined Federal Regulations* 33, chapter 1, part 6, ("Protection and Security of Vessels, Harbors, and Waterfront Facilities").

POSSE COMITATUS ACT

The *Posse Comitatus Act* provides that the Army and Air Force cannot be used to execute the laws. DOD Directive 5525.5 of 16 Jan 86 and SECNAVINST 5820.7 have applied the same restrictions to the Navy as a matter of DOD and DON policy.

Posse comitatus means the power or force of the county. It authorizes the sheriff to call a posse of citizens to help enforce the law. In the context of this statute and DOD policy, *posse comitatus* generally means that military personnel cannot be used to enforce civilian laws. This law does not prohibit such individuals from making a citizen's arrest for a felony or breach of the peace committed in their presence or from issuing citations for appearance before a U.S. magistrate. It also doesn't prevent them from performing other duties that support the role of the military; for example, protecting government personnel and property.

STATUS OF FORCES AGREEMENTS

LEARNING OBJECTIVES: State the purpose of status of forces agreements. Describe the application of status of forces agreements and the jurisdictional arrangements. Explain fairness of jurisdiction and the importance of status of forces agreements.

The development of collective defense in peacetime requires that forces of various countries form an integrated force for their common defense. This development requires that these forces be stationed in the territory of another treaty country. It also requires that they be free to move from one country to another to comply with the demands of strategy. It is essential, therefore, to have uniform arrangements and procedures governing the status of such forces and their relationship to the civilian authorities in countries other than their own.

The purpose of status of forces agreements is to define the status of the forces of one country when stationed in the territory of another. Status of forces agreements, accordingly, undertake to regulate this relationship in two ways:

1. Guaranteeing the armed forces adequate legal protection without, at the same time, infringing on the authority of the military command
2. Recognizing fully the peacetime rights and responsibilities of the civilian authorities in the host countries

APPLICATION OF STATUS OF FORCES AGREEMENTS

The status of forces agreements apply to personnel belonging to the land, sea, and air armed services, as well as to civilian personnel accompanying a force. Article II of the NATO Status of Forces Agreement, for example, sets forth the basic principle to be observed by any force in a country other than its own:

It is the duty of a force and its civilian component and the members thereof as well as their dependents to respect the law of the receiving State, and to abstain from any activity inconsistent with the spirit of the present Agreement, and in particular, from any political activity in the receiving State. It is also the duty of the sending State to take necessary measures to that end.

JURISDICTIONAL ARRANGEMENTS

The jurisdictional arrangements of the status of forces agreements are important in terms of fairness of trial. When we object to trial of United States personnel in foreign courts, we do so for a particular reason: We feel that a member of our forces, tried in a foreign court under a different legal system and in a language he or she does not understand, may not receive a fair trial.

FAIRNESS OF JURISDICTION

In considering the question of fairness, two basic points must be observed. First, the effect of a status of forces agreement is not to grant jurisdiction to foreign courts over American defendants when those courts would not otherwise have jurisdiction in the case. On the contrary, the agreement gives the United States the primary right to exercise concurrent jurisdiction in some cases. In other cases of concurrent jurisdiction, the agreement expressly provides mechanics for, and thereby encourages, foreign courts to waive jurisdiction over offenses that would otherwise be triable before them. If it were not for the status of forces agreements, many more service members would be tried by foreign courts. And though we may not always agree with foreign criminal procedures, our service members are afforded much more protection than they would otherwise receive if the status of forces agreements did not exist.

Secondly, since there is a yielding of jurisdiction to our military courts by the other parties to the status of forces agreements, we cannot expect that the American defendants who are tried by foreign courts to be tried under our own country's criminal procedure. Further, we cannot expect to obtain agreements that grant substantial concessions for criminal jurisdiction by a foreign country to also guarantee procedural safeguards in its courts beyond those available to its own citizens.

Military commanders of overseas commands have reported that the jurisdictional arrangements in the countries under their responsibility have worked well in practice. They have also reported that these arrangements have had no adverse effect upon the military mission of the Armed Forces or the morale and discipline of its members.

IMPORTANCE OF STATUS OF FORCES AGREEMENTS

From the foregoing discussion of the status of forces agreements, each MA assigned to duty overseas

should realize the need to develop a working knowledge of its provisions. You must remember at all times that you are a guest in a foreign country and are subject to that country's laws and procedures. Remember also that whatever privileges you possess, as compared with the ordinary visitor or tourist in that country, you possess only by the special consent of the host country. Only by giving thought to your mission as a member of the military forces of the United States will you understand why the host country extends certain privileges to you. In most countries, those privileges permit you to do the following:

- Use your United States driver's permit as authorization to drive
- Take household goods and personal belongings, including your car, into the country without paying any customs duty or taxes
- Enter and leave the country on military orders alone, without a passport or visa
- Spend money freely in the foreign country without paying foreign taxes on property and salary

Lastly, remember that as a guest in a foreign country, you are subject to that country's criminal laws and procedures. If you break any of these laws, you may find yourself on trial before a foreign court. Only by the consent of the host country can you be tried by the courts of your own service for offenses committed on foreign soil. Trial by the courts of your own service is not a matter of absolute right, but a privilege embodied in status of forces agreements.

Military Requirements for Senior and Master CPO, NAVEDTRA 12048, illustrates the general form and scope of the many agreements of the NATO status of forces agreements.

APPREHENSION AND RESTRAINT

LEARNING OBJECTIVES: Explain the UCMJ articles that apply to apprehension and restraint. Define apprehension. Describe apprehension as it relates to approach, evaluation, and taking into custody.

Because Masters-at-Arms make a large percentage of all apprehensions in the Navy, you should clearly understand the legal meanings of the word apprehension and other terms such as arrest, custody,

confinement, and restraint. The authority of Navy law enforcement personnel to enforce military law, orders, and regulations is derived from Title 10, U.S. Code 807, and *Manual for Courts-Martial (MCM)*, Rule 302.

UCMJ ARTICLES

As a preface to this section, applicable Articles 7 through 14 of the *UCMJ* are quoted verbatim and are followed in some cases by clarifying explanations that point out legal considerations not always obvious in the quoted article.

Within the quoted material of this section, you will see a reference to persons "subject to this chapter." "Chapter" refers to the chapter of the *MCM* that contains the articles of the *UCMJ* under discussion, not to this chapter of the training manual.

Articles 7 through 14 directly concern MAs because they are the basis of "the law" as it relates to taking persons into custody, methods of restraint, and authority to order persons into arrest or confinement.

Article 7—Apprehension

(a) Apprehension is the taking of a person into custody.

(b) Any person authorized under regulations governing the armed forces to apprehend persons subject to this chapter or to trial thereunder may do so upon reasonable belief that an offense has been committed and that the person apprehended committed it.

(c) Commissioned officers, warrant officers, petty officers, and noncommissioned officers shall have authority to quell quarrels, frays, and disorders among persons subject to this chapter, and to apprehend persons subject to this chapter who take part therein.

Section (a) defines apprehension as taking a person into custody. As you will see later, a person is placed under arrest only on the order of an officer. As a practical matter, the fact that you say, "I'm placing you under arrest" instead of "I'm apprehending you" makes no legal difference. The important point is that the offender must be informed clearly that he or she is being taken into custody. The offender won't know unless told. The *MCM* defines custody in part as "restraint of free locomotion, which is imposed by

lawful apprehension.” To make the custody clear, you should normally use some indication of physical restraint, such as taking the offender by the arm. This procedure is not always wise, of course, especially if the offender is argumentative or drunk. Use good judgment when using physical restraint. Remember that the purpose of taking a person into custody is only to restrain the violator until proper authority can be notified.

The *MCM* clarifies the words in section (b) “authorized under regulations governing the armed forces . . . ” to include all petty officers. The important point here is the “reasonable belief.” The initial action of apprehending a person is legally sufficient if a reasonable belief exists that the person has committed an offense. Legal proof is seldom available at this stage unless you actually see the violation take place.

Although section (b) uses the words “reasonable belief to justify apprehension, section (c) has no restriction whatever. By virtue of your rating badge, you have the authority to take into custody persons involved not only in a fight, but in a quarrel (angry dispute) as well. The idea, of course, is to stop the quarrel before it develops into a brawl. But sometimes the only way to stop it is to take the individuals into custody, and Article 7 gives you this authority.

Article 7 includes taking custody of any U.S. service member, Navy or otherwise.

Article 8—Apprehension of Deserters

Any civil officer having authority to apprehend offenders under the laws of the United States or of a State, Territory, Commonwealth, or possession, or the District of Columbia may summarily apprehend a deserter from the armed forces and deliver him into the custody of these forces.

Generally speaking, a civilian has no authority to apprehend a suspected deserter. Usually the civilian notifies a civil or military authority about suspicions of desertion. However, once the military sends out a formal declaration that a person is a deserter and offers a reward for picking the deserter up, a private citizen has sufficient authority to apprehend. Even if a civilian apprehends and delivers a deserter without authority, that deserter will be held for trial. A deserter may be apprehended by anyone—the FBI, military police, civil police, and private citizens.

Article 9—Imposition of Restraint

(a) Arrest is the restraint of a person by an order, not imposed as a punishment for an offense, directing him to remain within certain specified limits. Confinement is the physical restraint of a person.

(b) An enlisted member may be ordered into arrest or confinement by any commissioned officer by an order, oral or written, delivered in person or through other persons subject to this chapter. A commanding officer may authorize warrant officers, petty officers, or noncommissioned officers to order enlisted members of his command or subject to his authority into arrest or confinement.

(c) A commissioned officer, a warrant officer, or a civilian subject to this chapter or to trial thereunder may be ordered into arrest or confinement only by a commanding officer to whose authority he is subject, by an order, oral or written, delivered in person or by another commissioned officer. The authority to order such persons into arrest or confinement may not be delegated.

(d) No person may be ordered into arrest or confinement except for probable cause.

(e) Nothing in this article limits the authority of persons authorized to apprehend offenders to secure the custody of an alleged offender until proper authority may be notified.

Congress has given the terms apprehension, arrest, and confinement distinct meanings. Apprehension, as you learned from Article 7, is the initial act of taking a person into custody. Once a person is taken into custody, that person may be held under restraint for safekeeping while the charges are disposed of. There are three forms of such restraint. The most severe is confinement—the physical restraint of a person. Next comes arrest, which is the restraint of a person by an order directing him or her to remain within certain specified limits. The least severe form of restraint for safekeeping is restriction in lieu of arrest, which is also imposed by an order directing the person to remain within certain specified limits. The difference between arrest and restriction in lieu of arrest is that a restricted person performs all regular duties, whereas a person under arrest does not perform

full military duties. For this reason, personnel who commit relatively minor offenses are normally put under restriction in lieu of arrest.

Confinement, arrest, and restriction in lieu of arrest, when imposed under Article 9, are not forms of punishment. Arrest and restriction in lieu of arrest are similar in one respect: the party is required to stay within specified limits. It is a person's conscience and the force of law, rather than a strong arm or a barred door, that induce an individual to remain within those limits. A person obeys because of a moral and legal obligation to do so.

Confinement before trial is usually not imposed. However, it is imposed if needed to ensure the presence of the accused at the trial, if the offense charged is extremely serious, or if the safety of the public or the accused is in jeopardy.

Article 10—Restraint of Persons Charged With Offenses

Any person subject to this chapter charged with an offense under this chapter shall be ordered into arrest or confinement, as circumstances may require; but when charged only with an offense normally tried by a summary court-martial, he shall not ordinarily be placed in confinement. When any person subject to this chapter is placed in arrest or confinement prior to trial, immediate steps shall be taken to inform him of the specific wrong of which he is accused and to try him or to dismiss the charges and release him.

This article, requiring "immediate steps" to try the accused, is strengthened by Article 98, which makes punishable by court-martial any unnecessary delay in the disposition of a case. However, undue haste also is frowned upon. In time of peace no person may, against his or her objection, be brought to trial before a general court-martial within 5 days after being served charges or before a special court-martial within 3 days after being served charges (Article 35).

The *MCM* amplifies this article by permitting an authorized arresting officer merely to restrict an accused person to specified areas of the military command (restriction in lieu of arrest). (See discussion under Article 9.)

Article 11—Reports and Receiving of Prisoners

(a) No provost marshal, commander of a guard, or master-at-arms may refuse to receive or keep any prisoner committed to his charge by a commissioned officer of the armed forces, when the committing officer furnishes a statement, signed by him, of the offense charged against the prisoner.

(b) Every commander of a guard or master-at-arms to whose charge a prisoner is committed shall, within twenty-four hours after that commitment or as soon as he is relieved from guard, report to the commanding officer the name of the prisoner, the offense charged against him, and the name of the person who ordered or authorized the commitment.

An arrest is imposed by notifying the person to be arrested that he or she is under arrest and informing that person of the limits of the arrest. The order to arrest may be oral or written. A person to be confined is placed under guard and taken to the place of confinement.

Article 12—Confinement With Enemy Prisoners Prohibited

No member of the armed forces may be placed in confinement in immediate association with enemy prisoners or other foreign nationals not members of the armed forces.

However, members of the Armed Forces may be confined in the same jails, prisons, or other confinement facilities with the categories mentioned above if they are separated from them.

Article 13—Punishment Prohibited Before Trial

Subject to section 857 of this title (Article 57), no person, while being held for trial or as the result of trial, may be subjected to punishment or penalty other than arrest or confinement upon the charges pending against him, nor shall the arrest or confinement imposed upon him be any more rigorous than the circumstances required to ensure his presence, but he may be subjected to minor punishment during that period for infractions of discipline.

The minor punishment permitted under Article 13 includes that authorized for violations of discipline required by the place of confinement. The article does not prevent a person from being required to do ordinary cleaning or policing or from taking part in routine training and duties not involving the bearing of arms.

Article 14—Delivery of Offenders to Civil Authorities

(a) Under such regulations as the Secretary concerned may prescribe, a member of the armed forces accused of an offense against civil authority may be delivered, upon request, to the civil authority for trial.

(b) When delivery under this article is made to any civil authority of a person undergoing sentence of a court-martial, the delivery, if followed by conviction in a civil tribunal, interrupts the execution of the sentence of the court-martial, and the offender after having answered to the civil authorities for his offense shall, upon the request of competent military authority, be returned to military custody for the completion of his sentence.

APPREHENSION

Apprehension is the military equivalent of the civilian term *arrest*. Any officer, warrant officer, noncommissioned officer, or other person designated by proper authority to perform guard, police, or criminal investigation duties may apprehend a violator.

Custody means restraint of free movement. When an individual is taken into custody, the individual's movements are controlled by the person or persons who made the apprehension.

Physical restraint is the loss of free movement that results from being taken into custody. It may involve force or may be accomplished by obedience to orders. Even if force is not used, a Master-at-Arms must be able to apply force if needed to effect an apprehension; that is, the MA must be able to restrain forcibly an offender who resists apprehension. The use of force depends on whether or not the offender submits to the apprehension.

The procedure for apprehending depends upon its necessity, the manner in which an offender is approached, an evaluation of the facts and

circumstances, and the manner in which custody is imposed. Although no formal procedure can apply in all cases, the following information emphasizes what a Master-at-Arms should consider.

WHEN TO APPREHEND

Apprehension is made only for probable cause. If facts and circumstances indicate that a person has committed an offense, then an apprehension may be justified. All offenses, however, do not require apprehension. A minor offense or traffic violation may require only an on-the-spot correction, an incident report, or a traffic citation. When to apprehend depends on the facts and circumstances of the offense and your judgment and experience. No two offenders are identical. Officers should not be apprehended except on the orders of another officer or because of the seriousness of the offense.

Two-person Approach

Masters-at-Arms usually work in pairs to assist each other when the occasion requires. In an apprehension involving force, the advantage of two persons is clear.

When approaching an offender, the senior MA takes a position to the right front of the offender. This approach provides a defense against a direct frontal attack and allows for restraining action. The second MA takes a position to the left rear of the offender, ready to assist if necessary. The senior MA does all questioning and checking of identification. If the offender is against a wall, the MAs form a V to the left and right front of the offender. This approach allows them to protect themselves and overcome any resistance.

Politeness pays off in a smooth apprehension, a minimum use of force, better public relations, and increased respect for law enforcement. A smooth, courteous, and efficient approach and a firm but friendly conversational tone usually calm all but the most violent offenders.

Evaluation

In deciding whether to apprehend a suspect, the Master-at-Arms must make an evaluation of the person. The MA must evaluate the suspect's attitude, possible injuries the suspect might have received, and any indication of a probable cause to apprehend.

A suspect is either cooperative or uncooperative. An uncooperative attitude is a good indication that an apprehension is necessary and force may be required. A cooperative attitude, in itself, does not always indicate innocence. Experienced offenders sometimes appear to be model sailors.

Always check a suspect for any injuries that require medical attention. That is particularly important when the suspect has been in a fight or is intoxicated. A seemingly minor injury could be serious, and the few minutes required for medical attention may clear you of negligence.

Considering all the circumstances, the senior MA will decide whether probable cause exists to make an apprehension. Since an apprehension is not a trial, a reasonable belief that the person has committed an offense is sufficient grounds to support an apprehension. Proof beyond a reasonable doubt is NOT required at this point. If the apprehension has been ordered by higher authority, no further decision is necessary. Once decided upon, an apprehension should be made quickly, without hesitation or argument. The objective is to remove the suspect from the scene with minimum delay.

Taking Into Custody

An apprehension is effected when the suspect is told that he or she is being taken into custody. A simple statement such as "You're under apprehension" or "I'm taking you into custody" is sufficient. The suspect should not have any doubts about his or her status.

Immediately upon apprehension, search the suspect for weapons. You may simply frisk the suspect or, if warranted, thoroughly search both the suspect and the area under the suspect's immediate control. As the apprehending officer, you may search for weapons to ensure your own safety or search for tools that might enable the suspect to escape. You need not search every area in a room in which a suspect is apprehended; instead, search only that area of the room under the suspect's immediate control. Thus, the scope of the search depends on the circumstances involved in the apprehension.

If circumstances allow, warn a suspect of his or her right against self-incrimination in accordance with Article 31, *UCMJ*. Although formal interrogations are rarely made at the scene of an apprehension, any confession or admission obtained from the suspect at the scene is inadmissible in court unless the suspect is

first warned of his or her rights under Article 31, *UCMJ*.

CITIZEN'S RIGHT TO ARREST

LEARNING OBJECTIVES: Explain the citizen's right to arrest. Describe personal liability when making a citizen's arrest, and identify the two defenses that are available if an MA is brought to trial.

All members of the Navy have the ordinary right of civilians to assist in maintaining peace. Generally, this right means members of the Navy (including MAs) have the authority to apprehend any person who commits a felony or who in their presence commits a misdemeanor amounting to a breach of the peace.

PERMISSION TO APPREHEND

Since the law of apprehension varies considerably in different localities, an MA ordinarily apprehends under this right only with the permission of the commanding officer. Apprehension that involves the removal of a person from an area of military jurisdiction and an order not to reenter also requires the permission of the commanding officer. This type of apprehension normally occurs when a person not subject to military law is found in an area of military jurisdiction in the act of committing a violation not amounting to a felony or a breach of the peace.

PERSONAL LIABILITY DEFENSES

When actions for damages or criminal proceedings occur, the acts of Masters-at-Arms in aiding civil authorities to suppress domestic violence are subject to review by military and civil courts. An MA brought to trial for acts done while assisting civil authorities under circumstances authorized by constitutional or statutory provisions has two defenses for personal liability: military necessity and superior orders.

Military Necessity

The defense of military necessity is generally available to the officer in charge of the operation and to the Master-at-Arms. If the officer (or MA) can show that the action appeared to be necessary at the time because of the emergency, he or she is freed from guilt. If hindsight shows that better methods were available,

the officer (or MA) may still be absolved of legal responsibility.

Superior Orders

The defense of superior orders is ordinarily available to all military personnel who act under the order of a military superior. Under circumstances calling for prompt action, the Master-at-Arms cooperates with civil authority but is subject only to the authority of military superiors. The defense of superior orders is available unless an order is so obviously illegal that any person of ordinary understanding would instantly perceive it to be so. If the commands are illegal but not obviously so, the Master-at-Arms is not held liable if he or she obeys.

CONSTITUTIONAL CONSIDERATIONS

LEARNING OBJECTIVES: Describe and compare the fifth amendment to the Constitution with UCMJ, Article 31. Explain the preinterrogation warnings and the purpose of each part of Article 31.

The fifth amendment to the Constitution states, “nor shall any person be subject for the same offense to be twice put in jeopardy of life or limb; nor shall be compelled in any criminal case to be a witness against himself, nor be deprived of life, liberty, or property, without due process of law.” This provision of the Constitution is fundamental to the American legal system and to a democratic way of life.

Article 31 of the *UCMJ* is a statutory enactment of judicial interpretations of the fifth amendment protection against compulsory self-incrimination. Like all statutes, it is of a lesser importance than the constitutional provision. It is, however, broader than the constitutional guarantee and will, therefore, be used as a basis for discussing the rights of persons subjected to interrogation.

PREINTERROGATION WARNINGS

Before an individual can be questioned concerning an alleged crime that the individual is suspected of having committed, that person’s rights as afforded by the Constitution must be explained. This explanation of the individual’s rights is called a preinterrogation warning. To help you understand more of what is involved in this warning, we will look at what is required by the fifth amendment, how

Article 31 of the *UCMJ* incorporates the fifth amendment, and what procedures must be followed to properly administer a warning under Article 31, *UCMJ*.

FIFTH AMENDMENT RIGHTS

The fifth amendment to the U.S. Constitution provides, among other things, that no person “shall be compelled in any criminal case to be a witness against himself.” The sixth amendment requires that the accused in a criminal case “be informed of the nature . . . of the accusation” and that he have the “assistance of Counsel for his defense.” In passing the *UCMJ*, Congress enacted the spirit of the fifth amendment in Article 31. Much later, the Court of Military Appeals made a ruling that applied to the military. This ruling, based on a decision of the Supreme Court, made sure that if an accused person is interrogated in custody and the interrogator plans to use accused’s statements in evidence, the accused has not only the right to have the assistance of counsel, but must be advised of this right before any interrogation. Since you will be dealing with persons suspected of offenses, you will be interested primarily with real-world ramifications of these rights. When and by whom must a suspect be warned? What constitutes a valid warning? What are the consequences of a failure to warn?

ARTICLE 31

Article 31 is divided into four subsections, the first three of which regulate the activities of individuals who question or interrogate others. The fourth subsection prohibits the receipt into evidence of any statement taken from an accused in violation of the first three subsections.

Article 31a

“No person subject to this chapter may compel any person to incriminate himself or to answer any question, the answer to which may tend to incriminate him.” Compulsion and self-incrimination are the keys to understanding this subsection. Evidence is incriminating if it tends to establish guilt; interrogation is improper under Article 31 a if it compels the person being questioned to give responses that tend to establish his or her guilt. Notice that the article deals with “person(s),” not just suspects. The privilege against self-incrimination applies to both accused persons and to witnesses. The type of compulsion contemplated could involve an in-court

situation in which either a witness or the accused is required to answer questions.

In court, the accused has an absolute right not to take the stand and testify. An accused who chooses to take the stand to testify on any or all charges may be compelled to answer any questions concerning the charge or charges about which he or she testifies, even though the answer would be incriminating.

The accused may, however, take the stand and limit testimony to a collateral issue. The accused retains the privilege against self-incrimination about all other issues.

On the other hand, a witness maybe compelled to come to court, to take the stand, and to testify. The witness, however, may not be compelled to say anything self-incriminating.

The witness's privilege against self-incrimination is personal; the witness must assert that privilege personally. When the witness asserts that privilege, the ruling officer, usually the military judge, will decide if the answer will, in fact, incriminate the witness. A ruling officer who decides that it will not incriminate the witness will direct the witness to answer. If the determination of the ruling officer is incorrect, the answer cannot later be used in a trial against the witness, as the answer will have been compelled in violation of Article 31a.

Article 31b

Article 31b imposes the following three requirements:

(1) No person subject to this chapter may interrogate, or request any statement from, an accused or a person suspected of an offense without first informing him of the nature of the accusation, (2) advising him that he does not have to make any statement regarding the offense of which he is accused or suspected and, (3) that any statement made by him may be used against him in a trial by court-martial.

This is the subsection of Article 31 that will be most significant to you. As a Master-at-Arms, you will be intimately involved in interrogations and interviews with suspects. You must understand and comply with Article 3 lb to ensure the admissibility of any statement elicited.

Article 31c

No person subject to this chapter may compel any person to make a statement or produce evidence before any military tribunal if the statement or evidence is not material to the issue and may tend to degrade him.

This subsection is an enactment of a rule of evidence that precludes admission of immaterial or irrelevant evidence. The witness may be compelled to answer, no matter how degrading the answer may be, if the court determines the evidence to be material to the issue.

Article 31d

No statement obtained from any person in violation of this article or through the use of coercion, unlawful influence, or unlawful inducement may be received in evidence against him in a trial by court-martial.

This subsection is the teeth of Article 31. In general terms, it provides that evidence or statements obtained without affirmative compliance with Article 31 by the interrogator are inadmissible in a court-martial. A few examples are necessary to define the scope of unlawful influence and inducement:

- The interrogator tells the accused that if he or she doesn't make a statement, the interrogator will see that the accused's wife is arrested. Violation of Article 31.
- The interrogator tells the accused that if he or she makes a statement, the interrogator will see to it that the case will be handled in juvenile court and will not affect the accused's service. Violation of Article 31.
- The interrogator questions the accused for 12 hours straight. During that time, the interrogator makes the accused sit at attention, doesn't allow the accused to eat or smoke, and doesn't allow head calls.

A failure to comply with Article 31 does not necessarily mean that a guilty person goes free. Enough independent evidence may still exist to convict the person. At the very least, however, it does mean that the business of prosecuting charges will be needlessly complicated. A little experience will convince you that giving the required warnings is much easier than attempting to develop enough independent evidence for a conviction several years after the fact. It is easier even though such warnings

could make the interrogation more difficult. NOTE: IF IN DOUBT, WARN!

PROCEDURES FOR ADMINISTERING A WARNING

LEARNING OBJECTIVES: Identify who must be warned and who must give the warnings, and explain when the warnings must be given. Explain a cleansing warning and when acts are considered statements. Describe right to counsel, custodial interrogation, and scope of the right to counsel. Explain how to give the warnings under Article 31b.

As an MA, you will be required to administer Article 31, *UCMJ*, warnings to individuals who are either suspected of or accused of committing an offense under the *UCMJ*. The following discussions should help you become familiar with who can give the warning, when to give the warning, to whom the warning should be given, and how the warning should be given. Additionally, you should become familiar with the accused's right to counsel in connection with this warning.

WHO MUST BE WARNED?

Article 31b may be misinterpreted to mean that this subsection is applicable only to persons accused or suspected of an offense. If an individual is to be questioned merely as a witness, the individual need not be warned. However, if an interview of a witness clearly reveals that the witness may have committed a crime, the individual must be warned before continued interrogation.

WHO MUST GIVE THE WARNING?

Article 31b may also be misinterpreted to mean that only the persons subject to the *UCMJ* are required to give the warning. Persons not subject to the Code but employed by the Armed Forces for law enforcement or investigative purposes must give the warning. That includes Naval Criminal Investigative Service (NCIS) agents, security personnel agents, and their counterparts in other services. Persons acting on the request of the military in furtherance of a military investigation also must give warning.

WHEN MUST THE WARNINGS BE GIVEN?

Before ANY question may be asked of an accused or a suspect, warnings must be given. Warnings given after questioning will not meet the criteria set in

Article 31 and will not correct any error that prevented the use of statements made before the warning was given. If during questioning of a witness the interrogator suspects that the witness has committed some offense, the interrogator must give the warning as soon as he or she suspects the person's guilt.

CLEANSING WARNING

When an interrogator obtains a confession or admission without proper warning, subsequent compliance with Article 31 will not automatically make later statements admissible. That is best illustrated with the following example:

Assume the accused or suspect initially makes a confession or admission without proper warnings. That is called an involuntary statement and, because of the deficient warning, the statement is inadmissible at a court-martial. Next, assume the accused or suspect is later properly advised and then makes a second statement identical (or otherwise) to the first involuntary statement. Before the second statement can be admitted, the trial counsel must make a clear showing to the court that the second statement was both voluntary and independent of the first involuntary statement. There must be some indication that the second statement was not made only because the person felt the government already knew about the first confession and, therefore, he or she had nothing to lose by confessing again.

The Court of Military Appeals has sanctioned a procedure to be followed when a statement has been improperly obtained from an accused or suspect. In this situation, rewarn the accused giving all the warnings mandated. In addition, include a cleansing warning to this effect:

You are advised that the statement you made on _____ cannot and will not be used against you in a subsequent trial by court-martial.

The use of those exact words is not required. However, the trial counsel needs to use a cleansing warning of this type to clearly show that the second statement was not obtained from the first statement. Therefore, it is recommended that cleansing warnings be given when necessary.

Another problem in this area concerns the suspect who has committed several crimes. Suppose the interrogator knows of only one of these crimes and properly advises the suspect about the known offense. During the interrogation, the suspect relates the circumstances surrounding desertion, the offense about which the interrogator has warned the accused. During questioning,

however, the suspect tells the interrogator that while in a desertion status, he or she stole a military vehicle. Immediately upon learning about the additional offense, the interrogator must advise the suspect of his or her rights involving that offense. Only after that has been done may the interrogator begin interrogating the suspect about the additional crime.

If the interrogator does not follow this procedure, statements about the desertion may be admissible, but statements on the theft of the military vehicle probably will be excluded.

ACTS AS STATEMENTS

When an interrogator obtains a confession or admission, some acts, not usually thought of as statements, fall within the privilege against self-incrimination. When one of these acts is requested from an accused or suspect, Article 31 warnings must be given. The following is a selected list of protected acts:

- Asking an accused or suspect an incriminating question. But asking questions to establish identity, such as name, rank, address, or service number, are authorized.

- Requesting an accused or suspect to perform an act requiring conscious mental cooperation. “Verbal acts” or acts that amount to a statement—for example, having an individual identify property by pointing to it—also fall within the prohibited area. Acts that do not require cooperation and that are not protected under Article 31 include fingerprinting, placing a foot in a cast, trying on clothing, exhibition of the body, and physical examination by a licensed physician.

- Requiring an accused or suspect to submit to degrading acts or acts that shock the conscience. For example, the use of a stomach pump to obtain stomach contents or the use of a catheter to obtain urine is a violation of the due process of law because of the degrading nature of such acts. The extraction of blood is not considered degrading and is permitted under certain specific conditions.

RIGHT TO COUNSEL

Supreme Court decisions interpreting the sixth amendment have held that an accused who is in custody and who is to be interrogated has the right to counsel, and further, the right to be advised of his or her right to counsel. The Court of Military Appeals has held this rule to be applicable to military custodial interrogation (*U.S. v. Tempia*, 16 USCMA 629, 37

CMR 249 [1967]). Failure to advise the accused of the right to counsel or failure to provide counsel as requested will trigger an exclusionary rule similar to that contained in Article 31d. Evidence obtained at an interrogation in the absence of the *Tempia* warnings will be inadmissible at a trial by court-martial. Now let us consider two remaining points: custodial interrogation and scope of the right to counsel.

Custodial Interrogation

Custody does not depend on execution of any technicalities of placing a suspect under arrest. Rather, a suspect is considered to have been taken into custody if he or she has been deprived of freedom of action in any significant way or could reasonably believe he or she is in custody. Two examples will highlight the broad definition of the concept:

- Seaman Door is suspected by the CO of possessing marijuana. The CO directs Door to report to NCIS for questioning. Upon arrival at NCIS, Seaman Door, for the purposes of counsel warning requirements, is in custody.

- Airman Frost is seen downtown by the division officer, who is aware that Frost had been restricted last week by the CO for 30 days. The division officer stops Frost. Frost is in custody.

As a general rule, advice to the accused of the right to counsel is required whenever an Article 31 warning is required. The major exception to this rule is that the accused has no right to counsel at an Article 15 hearing (as opposed to a preheating interrogation). But the accused must be advised of the right to consult with independent counsel before making a decision concerning acceptance/rejection of nonjudicial punishment (NJP). Note, however, that no statement made at NJP in the absence of warnings as to the right to counsel can be used in a later court-martial proceeding.

Scope of the Right to Counsel

What are the rights to counsel of the accused? In the first place, counsel means a lawyer within the meaning of Article 27, *UCMJ*. The lawyer must be a judge advocate of one of the armed services. The lawyer also must be a graduate of an accredited law school or a member of the bar of a federal court or of the highest court of a state or be a civilian member of the bar of a federal court or of the highest court of a state. Unless the accused waives the right to counsel, a military lawyer will be appointed by military authority without cost to the accused. Alternatively, the accused has the right to retain a civilian counsel of choice at the

accused' sown expense. The accused has the absolute right to consult with counsel before the interrogation and to have counsel present during the interrogation.

An associated right, in itself not technically a part of the sixth amendment right to counsel, is that the accused has the power to end the interrogation at any time for any reason (or for no reason at all). If the accused indicates a desire to end the interview, it must be terminated. Failure to do so makes inadmissible any statement made after the request to terminate.

HOW TO GIVE THE WARNINGS

The foregoing discussions of fifth and sixth amendment rights have indicated that suspects have rights that mere witnesses do not have. Guidelines have been given to help you determine when a witness shifts to the suspect category. The concept of "in custody" has been explained. Now that you know how to fit the person who is being interrogated into the various categories, you are probably interested in a formula that ensures the admission of any evidence produced by an interrogation.

All suspects and accused persons are entitled to warnings flowing from rights guaranteed by both the fifth and sixth amendments. First, you must identify yourself by name and official position. Then, you should make the following statements to ensure that proper warnings have been given:

1. You are suspected of committing the following offense(s): [Describe the offense(s) here.]
2. You have the right to remain silent.
3. Any statement you do make may be used as evidence against you in trial by court-martial.
4. You have the right to obtain and consult with a lawyer, either a civilian lawyer retained by you at your own expense or, if you wish, a military lawyer who will be appointed to act as your counsel without cost.
5. You have the right to have a retained civilian lawyer or an appointed military lawyer present with you during this interview.
6. You have the right to terminate this interview at any time and for any reason.
7. Do you understand?
8. Do you waive your right to counsel?
9. Do you consent to making a statement?

Determining that the accused or suspect fully understands the rights is particularly important because in the absence of understanding, no intelligent choice can

be made to exercise or waive the rights. A court may later look not only at the words used in giving the warning, but also at the suspect's age, intelligence, and experience. For example, a suspect who is drunk at the time of his or her apprehension and original warning should be readvised of his or her rights before any subsequent questioning.

An accused will be advised in accordance with the Suspect's Acknowledgement and Waiver of Rights form. The accused will sign the form to indicate that he or she has been advised of his or her rights. The form is then retained in case it becomes necessary to prove in court that the warnings were properly given.

ARTICLE 31b

Remember from our previous discussion under "Constitutional Considerations" that Article 31 b imposes three requirements:

1. That the accused or suspect be informed of the nature of the accusation against him or her.
2. That the accused be told that he or she has the right to remain silent.
3. That the accused be advised that any statement made by him or her may be used as evidence against him or her at a trial by court-martial. The person giving the advice must also make certain that (1) the accused understands this advice and (2) that the accused affirmatively waives his or her rights before any statement is obtained. Accordingly, a proper Article 31 warning must be given.

For example, the accused is suspected of stealing two wallets containing a total of \$30. The Article 31 warning should be phrased as follows:

Seaman Brush, I advise you that I suspect you of stealing two wallets from the lockers of Seamen Boate and Doe last night. I advise you that you have the right to remain silent and, if you do say anything, what you say may be used against you as evidence in a trial by court-martial. Do you understand? Do you waive your rights and desire to make a statement?

It is NOT sufficient merely to read Article 31 to the accused. Neither is it in compliance with Article 31 to tell the accused that he or she need not "incriminate himself or herself."

If the accused indicates a desire to consult with a lawyer, ask no questions until a lawyer is obtained.

Likewise, if the accused does not wish to be questioned and has no lawyer present, ask no questions. If, after waiving the rights, the accused elects to make a statement or answer questions, the accused must complete and sign the Suspect's Rights and Acknowledgment form at the time the statement is recorded. If at all possible, have a witness present when the accused is informed of his or her rights and when the accused signs the form. If the accused orally waives the rights but refuses to sign the form, you may proceed with questioning. Make a note on the form to the effect that the accused has stated that he or she understands the rights, does not want a lawyer, wants to discuss the offense(s), and refuses to sign the form.

In all cases, complete the form as soon as possible. Make every effort to complete the form before any questioning begins. If you cannot complete the form at once, as in the case of the street interrogation, you may temporarily postpone completion of the form, but keep notes on the circumstances.

PUNITIVE ARTICLES OF UCMJ

LEARNING OBJECTIVES: Identify the punitive articles of the UCMJ. Read and explain each of the punitive articles contained in appendix III of this manual.

Articles 77 through 134 of *UCMJ* are referred to as punitive articles, which as a whole, cover almost any offense or crime that can be committed. Appendix III of this book covers the punitive articles.

You must remember to establish proof that the accused committed the alleged offense. All ELEMENTS of the offense MUST be met before the accused can be charged for violation of the offense.

The *Manual for Courts-Martial* (part IV, "Punitive Articles") contains specific information about each article. You should consult this part of the *MCM* to obtain the proper specifications when writing charges for NJP or courts-martial proceedings.

SUMMARY

In this chapter, we studied the sources for jurisdiction and discussed jurisdiction over the person, offense, and location. Types of jurisdiction, such as military, civilian, investigative, and territorial were covered. This section also included a dialogue on the service-connection issue, the assimilative crimes act, and the *Posse Comitatus Act*. Next we discussed the status of forces agreements as they relate to application, jurisdictional arrangements, fairness, and importance to members of the Navy. Then we defined apprehension and covered articles 7 through 14 of the UCMJ, which are the basis of "the law" as it relates to the authority for different types of custody. The citizen's right to arrest and two defenses against civil liability were covered next. The fifth amendment to the Constitution and *UCMJ* Article 31 were also discussed. The need for detailed procedures to administer and record a warning was included. Finally, the punitive articles, 77 through 134, were pointed out. Remember, the punitive articles are included in this manual as appendix III.

CHAPTER 3

SEARCH AND SEIZURE

What is a search? What are the rights of an individual being searched? What procedures must be followed in requesting and conducting a search? What are the different types of searches?

As an MA, you will undoubtedly be involved in conducting searches. Therefore, you must familiarize yourself with the procedures in conducting a search, preparation of the associated paper work, and the rights of the individual being searched. The following discussions are intended to help you answer the previous questions and become familiar with the standards that must be followed to make sure a search has been conducted properly. In addition to these discussions, you should familiarize yourself with the applicable command instructions and JAG directives on search and seizure procedures.

Each military member has a constitutionally protected right to privacy. However, a service member's expectation of privacy must occasionally be infringed upon because of military necessity. Military law recognizes that the individual's right to privacy is balanced against the command's legitimate interests in maintaining health, welfare, discipline, and readiness, as well as by the need to obtain evidence of criminal offenses.

Searches and seizures conducted according to the requirements of the *United States Constitution* will generally yield admissible evidence. On the other hand, evidence obtained in violation of constitutional mandates will not be admissible in any later criminal prosecution. With this in mind, the most productive approach for you is to develop a thorough knowledge of what actions are legally permissible (producing admissible evidence for trial by court-martial) and what actions are not. This understanding will enable the command to determine, before acting in a situation, whether prosecution will be possible. The legality of the search or seizure depends on what was done by the command at the time of the search or seizure. No amount of legal brilliance by a trial counsel (TC) at trial can undo an unlawful search and seizure.

SOURCES OF THE LAW OF SEARCH AND SEIZURE

LEARNING OBJECTIVES: Explain the Fourth Amendment to the *Constitution* and describe probable cause, particularly described, and the exclusionary rule. Identify how the *Manual for Courts-Martial* (MCM) applies to search and seizure in terms of the Military Rules of Evidence (MRE).

The two sources we will discuss regarding search and seizure include the Constitution and the MCM.

UNITED STATES CONSTITUTION

Although enacted long ago, the language of the Fourth Amendment to the *Constitution* has never changed. The Fourth Amendment was not an important part of American jurisprudence until this century when courts created an exclusionary rule based on its language:

The right of the people to be secure in their persons, houses, papers, and effects against unreasonable searches and seizures shall not be violated, and no warrants shall issue, but upon probable cause supported by oath or affirmation, and particularly describing the place to be searched, and the persons or things to be seized.

Probable Cause

An important concept contained in the Fourth Amendment is that of probable cause. This concept is not particularly complicated, nor is it as confusing as often assumed.

In deciding whether probable cause exists, you must first remember that conclusions of others do not comprise an acceptable basis for probable cause. The person who is called upon to determine probable cause must, in all cases, make an independent assessment of facts presented before a constitutionally valid finding of probable cause can be made. The concept of probable cause arises in many different factual situations. Numerous individuals in a command may be called upon to establish its presence during an investigation.

Although the reading of the *U.S. Constitution* would indicate that only searches performed pursuant to a warrant are permissible, there have been certain exceptions carved out of that requirement, and these exceptions have been classified as searches otherwise reasonable. Probable cause plays an important role in some of these searches that will be dealt with individually in this chapter.

Although the Fourth Amendment mandates that only information obtained under oath may be used as a basis for probable cause, military courts traditionally ignored this requirement. Still, it is strongly recommended that the information be given under oath. When a person takes an oath, it is a factor that adds to the believability of that person.

Particularly Described

The Fourth Amendment also provides that no search or seizure will be reasonable if the intrusion is into an area not particularly described. This requirement requires a particular description of the place to be searched and items to be seized. Thus, the intrusion by Government officials must be as limited as possible in areas where a person has a legitimate expectation of privacy.

Exclusionary Rule

The exclusionary rule of the Fourth Amendment is a judicially created rule based upon the language of the Fourth Amendment. The U.S. Supreme Court considered this rule necessary to prevent unreasonable searches and seizures by Government officials. In more recent decisions, the Supreme Court has reexamined the scope of this suppression remedy and concluded that the rule should only be applied where the Fourth Amendment violation is substantial and deliberate. So, where Government agents are acting in an objectively reasonable manner (in good faith), the evidence seized should be admitted despite technical violations of the Fourth Amendment.

MANUAL FOR COURTS-MARTIAL (MCM)

By a 1980 amendment to the MCM, the Military Rules of Evidence (MRE) were enacted. The MRE provide extensive guidance in the area of search and seizure in rules 300-317. Anyone charged with the responsibility for authorizing and conducting lawful searches should be familiar with those rules. Unlike the area of confessions and admissions, which are covered in Article 31 of the UCMJ, there is no basis

in the *Uniform Code of Military Justice* (UCMJ) for the military law of search and seizure.

THE LANGUAGE OF THE LAW OF SEARCH AND SEIZURE

LEARNING OBJECTIVES: Define the words and terms related to search and seizure.

Certain words and terms must be defined to properly understand their use in this chapter. These definitions are as follows:

SEARCH

A *search* is a quest for incriminating evidence. It is an examination of a person or an area with a view to the discovery of contraband or other evidence to be used in a criminal prosecution. Three factors must exist before the law of search and seizure will apply. Does the command activity constitute any of the following:

- A quest for evidence
- A search conducted by a Government agent
- A search conducted in an area where a reasonable expectation of privacy exists

If, for example, it were shown that the evidence in question had been abandoned by its owner, the quest for such evidence by a Government agent that led to the seizure of the evidence would present no problem, since there was no reasonable expectation of privacy of such property.

SEIZURE

A *seizure* is taking possession of a person or some item of evidence in conjunction with the investigation of criminal activity. The act of seizure is separate and distinct from the search, the two terms varying significantly in legal effect. On some occasions a search of an area may be lawful, but not a seizure of certain items thought to be evidence. Examples of this distinction will be seen later in this chapter. MRE 316 deals specifically with seizures and creates some basic rules for application of the concept. Except in cases of abandoned property, a proper person (such as anyone with the rank of E-4 or above) or a criminal investigator Naval Criminal Investigative Service (such as a (NCIS) special agent) must be used to make the seizure.

PROBABLE CAUSE TO SEARCH

Probable cause to search is a reasonable belief, based upon believable information having a factual basis, that a crime has been committed and that the person, property, or evidence sought is located in the place or on the person to be searched.

Probable-cause information generally comes from any of the following sources:

- Written statements
- Oral statements communicated in person, via telephone, or by other appropriate means of communication
- Information known by the authorizing officer (the commanding officer (CO))

PROBABLE CAUSE TO APPREHEND

Probable cause to apprehend an individual is similar in that an authority must conclude, based upon facts, that a crime was committed and that the person to be apprehended is the person who committed the crime.

A detailed discussion of the requirement for a finding of probable cause to search appears later in this chapter. Further discussion of the concept of probable cause to apprehend also appears later in this chapter in connection with searches incident to apprehension.

OBJECTS OF A SEARCH OR SEIZURE

LEARNING OBJECTIVES: List and describe eight categories of evidence that maybe seized.

In carrying out a lawful search or seizure, agents of the government are bound to look for and seize only items that provide some link to criminal activity. MRE 316 provides, for example, that the following categories of evidence may be seized:

- Unlawful weapons made unlawful by some law or regulation
- Contraband or items that may not legally be possessed
- Evidence of a crime that may include such things as instrumentalities of crime, items used to commit crimes, fruits of crime, such as stolen property, and

other items that aid in the successful prosecution of a crime

- Persons, when probable cause exists for apprehension
- Abandoned property that may be sized or searched for any or no reason, by any person
- Government property

With regard to government property, the following rules apply:

- Generally, government agents may search for and seize such property for any or no reason, and there is a presumption that no privacy expectation attaches.
- Footlockers or wall lockers are presumed to carry with them an expectation of privacy; thus they can be searched only when the Military Rules of Evidence permit.

CATEGORIZATION OF SEARCHES

LEARNING OBJECTIVES: Describe probable-cause searches with and without prior authorization. Explain searches not requiring probable cause.

In discussing the law of search and seizure, we can divide all search and seizure activity into two broad areas: those that require prior authorization and those that do not. Searches that do not require prior authorization are (1) searches requiring probable cause and (2) searches not requiring probable cause. Since the constitutional mandate of reasonableness is most easily met by searches based on prior authorization, authorized searches are preferred. The courts have recognized, however, that some situations require immediate action, and here the reasonable alternative is a search without prior authorization. Although this second category is more closely scrutinized by the courts, several valid approaches can produce admissible evidence.

PROBABLE-CAUSE SEARCHES BASED UPON PRIOR AUTHORIZATION

The military search authorization is a prior-authorization search, like that described in the text of the Fourth Amendment, but is the express product of MRE 315. Although the prior military law

contemplated that only officers in command could authorize a search, MRE 315 clearly intends that the power to authorize a search follows the billet occupied by the person involved, rather than be founded in rank or officer status. Thus, in those situations where senior noncommissioned or petty officers occupy positions as officers in charge (OICs) or positions similar to command, they are generally competent to authorize searches unless otherwise directed by the Secretary of the Navy.

In the typical case, the commander or other competent military authority, such as an OIC, decides, when issuing a search authorization, whether probable cause exists. Although there is no exclusion of COs per se, courts will decide, on a case-by-case basis, whether a particular commander was in fact neutral and detached. MRE 315(d) provides that:

An otherwise impartial authorizing official does not lose that character merely because he or she is present at the scene of a search or is otherwise readily available to persons who may seek the issuance of a search authorization; nor does such an official lose impartial character merely because the official previously and impartially authorized investigative activities when such previous authorization is similar in intent or function to a pretrial authorization made by the United States district courts.

Jurisdiction to Authorize Searches

Before any competent military authority can lawfully order a search and seizure, he or she must have the authority necessary over both the person and/or place to be searched, and the persons or property to be seized. This authority, or jurisdiction, is most often a dual concept—jurisdiction over the place and over the person. Any search or seizure authorized by one not having jurisdiction is a nullity and, even though otherwise valid, the fruits of any seizure would not be admissible in a trial by court-martial if objected to by the defense.

JURISDICTION OVER THE PERSON.— It is critical to any analysis of the authority of the CO over persons to determine whether the person is a civilian or military witness.

Civilians.—The search of civilians is now permitted under MRE 315(c) when they are present aboard military installations. This gives the military commander an additional alternative in such situations where the only possibility before the MRE was to

detain that person for a reasonable time while a warrant was sought from the appropriate federal or state magistrate. Furthermore, a civilian desiring to enter or exit a military installation may be subject to a reasonable inspection as a condition precedent to entry or exit. Such inspections have recently been upheld as a valid exercise by the commander of the administrative need for security of military bases. Inspections will be discussed later in this chapter.

Military.— MRE 315 indicates two categories of military persons who are subject to search by the authorization of competent military authority—members of that CO's unit and others who are subject to military law when in places under that CO's jurisdiction; for example, aboard a ship or in a command area. There is military case authority for the proposition that the commander's power to authorize searches of members of his or her command goes beyond the requirement of presence within the area of the command. In one case, the court held that a search authorized by the accused's CO, although actually conducted outside the squadron area, was nevertheless lawful. Although this search occurred within the confines of an Air Force base, a careful consideration of the language of MRE 315(d)(1) indicates that a person subject to military law could be searched even while outside the military installation. This would hold true only for the search of the person, since personal property located off base is not under the jurisdiction of the CO if situated in the United States, its territories, or possessions.

JURISDICTION OVER THE PROPERTY.—

Several topics must be considered when determining whether a CO can authorize the search of property. It is necessary to decide first if the property is Government-owned and, if so, whether it is intended for Governmental or private use. If the property is owned, operated, or subject to the control of a military person, its location determines whether a commander may authorize a search or seizure. If the private property is owned or controlled by a civilian, the commander's authority does not extend beyond the limits of the pertinent command area.

Property that is Government-owned and not intended for private use may be searched at any time, with or without probable cause, for any reason, or for no reason at all. Examples of this type of property include Government vehicles, aircraft, ships.

Property that is Government-owned but has a private use by military persons (therefore, an expectation of privacy) may be searched by the order of

the CO having control over the area, but probable cause is required. An example of this type of property is a BOQ/BEQ room.

MRE 314 attempts to remove the confusion about which kinds of Government property involve expectations of privacy. The intent of the rule in this area is to affirm that there is a presumed right to privacy in wall lockers, footlockers, and in items issued for private use. With other Government equipment, there is a presumption that no personal right to privacy exists.

Property that is privately owned and controlled or possessed by a military member within a military command area (including ships, aircraft, and vehicles) within the United States, its territories, or possessions, may be ordered searched by the appropriate military authority with jurisdiction—if the probable-cause requirement is fulfilled. Examples of this type of property include automobiles, motorcycles, and luggage.

Private property that is controlled or possessed by a civilian (any person not subject to the UCMJ) may be ordered searched by the appropriate military authority only if such property is within the command area (including vehicles, vessels, or aircraft). If the property ordered searched is, for example, a civilian banking institution located on base, attention must be given to any additional laws or regulations that govern those places.

Searches outside the United States, its territories or possessions, constitute special situations. Here the military authority or his or her designee may authorize searches of persons subject to the UCMJ, their personal property, vehicles, and residences, on or off a military installation. Any relevant treaty or agreement with the host country should be complied with. The probable-cause requirement still exists. Except where specifically authorized by international agreement, foreign agents do not have the right to search areas considered extensions of the sovereignty of the United States.

Delegation of the Power to Authorize Searches

Traditionally, commanders have delegated their power to authorize searches to their chief of staff, command duty officer (CDO), or even the officer of the day (OOD). This practice was held to be illegal, as the Court of Military Appeals has held that a CO may not delegate the power to authorize searches and seizures to anyone except a military judge or military magistrate. The court decided that most searches authorized by delegees such as CDOs would result in unreasonable searches or seizures in violation of the Fourth Amendment. If full command responsibility

devolves upon a subordinate, that person may authorize searches and seizures, since the subordinate in such cases is acting as the CO. General command responsibility does not automatically devolve to the CDO, OOD, or even the executive officer (XO) simply because the CO is absent. Only if full command responsibilities devolve to a subordinate member of the command may that person lawfully authorize a search. If, for example, the CDO or OOD must contact a superior officer or the CO before acting on any matter affecting the command, full command responsibilities will not have devolved to that person and, therefore, he or she could not lawfully authorize a search or seizure. Guidance on this matter has been issued by the Commander in Chief Atlantic Fleet (CINCLANTFLT), Commander in Chief Pacific Fleet (CINCPACFLT), and Commander in Chief U.S. Naval Forces, Europe (CINCUSNAVEUR). Until the courts provide further guidance on this issue, you should follow the guidance set forth by your respective CINCs.

The Requirement of Neutrality and Detachment

A commander must be neutral and detached when acting on a request for search authorization. The courts have issued certain rules that, if violated, will void any search authorized by a CO on the basis of lack of neutrality and detachment. These rules are designed to prevent an individual who has entered the evidence-gathering process from thereafter acting to authorize a search. The intent of both the courts' decisions and the rules of evidence is to maintain impartiality in each case. Where a commander has become involved in any capacity concerning an individual case, the commander should carefully consider whether his or her perspective can truly be objective when reviewing later requests for search authorization.

If a commander is faced with a situation in which action on a search authorization request is impossible because of a lack of neutrality or detachment, a superior commander in the chain of command or another commander who has jurisdiction over the person or place should be asked to authorize the search.

The Requirement for Probable Cause

As discussed earlier, the probable-cause determination is based upon a reasonable belief that a crime was committed and that certain persons, property, or evidence related to that crime will be found in the place or on the persons to be searched.

Before an authority may conclude that probable cause to search exists, he or she should have a

reasonable belief that the information giving rise to the intent to search is believable and has a factual basis.

The portion of MRE 315 dealing with probable cause recognizes the proper use of hearsay information in the determination of probable cause and allows such determinations to be based either wholly or in part on such information.

Probable cause must be based on information provided to or already known by the authorizing official. Such information can come to the commander through written documents, oral statements, messages relayed through normal communications procedures, such as the telephone or by radio, or may be based on information already known by the authorizing official.

In all cases, both the factual basis and believability basis should be satisfied. The factual basis requirement is met when an individual reasonably concludes that the information, if reliable, adequately apprises him or her that the property in question is what it is alleged to be and is located where it is alleged to be. Information is believable when an individual reasonably concludes that it is sufficiently reliable to be believed.

The method of application of the tests will differ, however, depending upon circumstances. The following examples are illustrative:

- An individual making a probable-cause determination who observes an incident firsthand must determine only that the observation is reliable and that the property is likely to be what it appears to be. For example, an officer who believes that he or she sees an individual in possession of heroin must first conclude that the observation was reliable (whether his or her eyesight was adequate and the observation was long enough) and that he or she has sufficient knowledge and experience to be able reasonably to believe that the substance in question is in fact heroin.

- An individual making a probable-cause determination who relies upon the in-person report of an informant must determine both that the informant is believable and that the property observed is likely to be what the observer believes it to be. The determining individual may consider the demeanor of the informant to help determine whether the informant is believable. An individual known to have a clean record and having no bias against the suspect is likely to be credible.

- An individual making a probable-cause determination who relies upon the report of an informant not present before the authorizing official must determine both that the informant is believable and that the information supplied has a factual basis. The individual making the determination may use one or more of the

following factors to decide whether the informant is believable:

- Prior record as a reliable informant—Has the informant given information in the past that proved to be accurate?

- Corroborating detail—Has enough detail of the informant's information been verified to imply that the remainder can reasonably be presumed to be accurate?

- Statement against interest—Is the information given by the informant sufficiently adverse to the pecuniary or penal interest of the informant to imply that the information may reasonably be presumed to be accurate?

- Good citizen—Is the character of the informant, as a person known by the individual making the probable-cause determination, such as to make it reasonable to presume that the information is accurate?

These factors are not the only ways to determine an informant's believability. The commander may consider any factor tending to show believability, such as the informant's military record, his or her duty assignments, and whether the informant has given the information under oath.

Mere allegations, however, may not be relied upon. Thus, an individual may not reasonably conclude that an informant is reliable simply because the informant is described as such by a law enforcement agent. The individual making the probable-cause determination should be supplied with specific details of the informant's past actions to allow that individual to personally and reasonably conclude that the informant is reliable. The informant's identity need not be disclosed to the authorizing officer, but it is often a good practice to do so.

Finally, probable cause must be determined by the person who is asked to authorize the search without regard to the prior conclusions of others on the question to be answered. No conclusion of the authorizing official should ever be based on a conclusion of some other person or persons. The determination that probable cause exists can be arrived at only by the officer charged with that responsibility.

Execution of the Search Authorization

MRE 315(h) provides that a search authorization or warrant be served upon the person whose property is to be searched if that person is present. Further, the persons who actually perform the search should compile an inventory of items seized and should give

a copy of the inventory to the person whose property is seized. If searches are carried out in foreign countries, the rule provides that actions should conform to any existing international agreements. Failure to comply with these provisions, however, will not necessarily render the items involved inadmissible at a trial by court-martial.

Record of Search Authorization

Although written forms are not mandatory, they are highly recommended for several reasons. Many

cases may take some time to get to trial, and it is helpful to the parties involved to review such documents before testifying. Further, these records may be introduced to prove that the search was lawful.

The Judge Advocate General of the Navy has recommended the use of the standard record of search authorization form, set forth in the *JAG Manual* and shown in figure 3-1. Should the situation require an immediate determination of probable cause, with no time to use the form, make a record of all facts used

RECORD OF AUTHORIZATION TO SEARCH
(See JAGMAN 0170)

1. At _____ on _____ I was approached by _____
Time Date Name, Rate, Service
 in his or her capacity as _____ who having been first duly sworn, advised me that
Duty
 he or she suspected _____ of _____ and requested permission
Name Offense
 to search his or her _____ for _____
Object or Place Items

2. The reasons given to me for suspecting the above named person were:

3. After carefully weighing the foregoing information, I was of the belief that the crime of _____
 _____ [had been] [was being] [was about to be] committed, that
 _____ was the likely perpetrator thereof, that a search of the object or
 area stated above would probably produce the items stated and that such items were [the fruits of
 crime] [the instrumentalities of a crime] [contraband] [evidence].

4. I have therefore authorized _____ to search the place named for the
 property specified, and if the property be found there, to seize it.

Grade Signature Title

Date and Time

Figure 3-1.—Record of authorization to search.

and actions taken as soon as possible after the events have occurred.

PROBABLE-CAUSE SEARCHES WITHOUT PRIOR AUTHORIZATION

As discussed earlier, there are two basic categories of searches that can be lawful if properly executed. Our discussion to this point has centered on those types of searches that require prior authorization. We will now discuss those categories of searches that have been recognized as exceptions to the general rule requiring authorization before the search. Recall that within this category of searches there are searches requiring probable cause and searches not requiring probable cause.

Exigency Searches

This type of search is permitted by MRE 315(g) under circumstances demanding some immediate action to prevent removal or disposal of property believed, on reasonable grounds, to be evidence of a crime. Although the exigencies may permit a search to be made without the requirement of a search authorization, the same quantum of probable cause required for search authorizations must be found to justify an intrusion based on exigency. Prior authorization is not required under MRE 315(g) for a search based upon probable cause under the following circumstances:

INSUFFICIENT TIME.— No authorization need be obtained where there is probable cause to search and there is a reasonable belief that the time required to obtain an authorization would result in the removal, destruction, or concealment of the property or evidence sought. Although both military and civilian case law, in the past, have applied this doctrine almost exclusively to automobiles, it now seems possible that this exception may be a basis for entry into barracks and apartments in situations where drugs are being used. The Court of Military Appeals found that an OOD, when confronted with the unmistakable odor of burning marijuana outside the accused's barracks room, acted correctly when he demanded entry to the room and placed all occupants under apprehension without first obtaining the CO's authorization for his entry. The fact that he heard shuffling inside the room and was on an authorized tour of living spaces was considered crucial, as well as the fact that the unit was overseas. The court felt that this was a present danger to the military mission,

and thus military necessity warranted immediate action.

LACK OF COMMUNICATION.— Action is permitted in cases where probable cause exists and destruction, concealment, or removal is a genuine concern, but communication with an appropriate authorizing official is prevented by reasons of military operational necessity. For instance, where a nuclear submarine, or a Marine Corps unit in the field maintaining radio silence lacks a proper authorizing official (perhaps due to some disqualification on neutrality grounds), no search would otherwise be possible without breaking the silence and perhaps endangering the unit and its mission.

SEARCH OF OPERABLE VEHICLES.— This type of search is based upon the U.S. Supreme Court's creation of an exception to the general warrant requirement where a vehicle is involved. Two factors are controlling. First, a vehicle may easily be removed from the jurisdiction if a warrant or authorization were necessary; and second, the court recognizes a lesser expectation of privacy in automobiles. In the military, the term *vehicle* includes vessels, aircraft, and tanks, as well as automobiles, trucks, and so on. If probable cause exists to stop and search a vehicle, then authorities may search the entire vehicle and any containers found therein in which the suspected item might reasonably be found. All this can be done without an authorization. It is not necessary to apply this exception to government vehicles, as they maybe searched any time and any place under the provisions of MRE 314(d).

SEARCHES NOT REQUIRING PROBABLE CAUSE

MRE 314 lists several types of lawful searches that do not require either a prior search authorization or probable cause.

Searches Upon Entry to or Exit From U.S. Installations, Aircraft, and Vessels Abroad

Commanders of military installations, aircraft, or vessels located abroad may authorize personnel to conduct searches of persons or property upon entry to or exit from the installation, aircraft, or vessel. The justification for the search is the need to make sure the security, military fitness, or good order and discipline of the command are maintained.

Consent Searches

If the owner, or other person in a position to do so, consents to a search of his or her person or property over which he or she has control, a search may be conducted by anyone for any reason (or for no reason) pursuant to MRE 314(e). If a free and voluntary consent is obtained, no probable cause is required. For example, where an investigator asks the accused if he or she "might check his or her personal belongings" and the accused answers, "Yes . . . it's all right with me," the Court of Military Appeals has found that there was consent.

The court has also said, however, that mere agreement in the face of authority is not consent. Thus, where the CO and the chief Master-at-Arms appeared at the accused's locker with a pair of bolt cutters and asked if they could search, the accused's affirmative answer was not consent. The question in each case will

be whether consent was freely and voluntarily given. Voluntary consent can be obtained from a suspect who is under apprehension if all other facts indicate it is not mere acquiescence.

Except under the Navy's urinalysis program, there is no absolute requirement that an individual who is asked for consent to search be told of the right to refuse such consent, nor is there any requirement to warn under Article 31(b), even when the individual is a suspect before consent is requested, (OPNAVINST 5350.4 currently requires the Navy to inform a member of his or her right to refuse a consent urinalysis.) Both warnings can help show that consent was voluntarily given. The courts have been unanimous in finding such warnings to be strong indicia that any waiver of the right to privacy thereafter given was free and voluntary.

Additionally, use of a written consent to search form is a sound practice. JAGMAN 0170 and figure 3-2

<p>CONSENT TO SEARCH (See JAGMAN 0170)</p> <p>I, _____, have been advised that inquiry is being made in connection with _____ . I have been advised of my right not to consent to a search of [my person] [the premises mentioned below]. I hereby authorize _____ and _____, who [has] [have been] identified to me as _____ to conduct a complete search of _____ Position(s) my [person] [residence] [automobile] [wall locker] [_____] located at _____</p> <p>I authorize the above listed personnel to take from the area searched any letters, papers, materials, or other property which they may desire. This search may be conducted on _____ Date</p> <p>This written permission is being given by me to the above named personnel voluntarily and without threats or promises of any kind.</p> <p style="text-align: center;">_____ Signature</p> <p>WITNESSES</p> <p>_____</p> <p>_____</p>

Figure 3-2.—Consent to search.

Illustrate the consent to search form that should be used. Remember that since the consent itself is a waiver of a constitutional right by the person involved, it may be limited in any manner or revoked at any time. The fact that you have the consent in writing does not make it binding on a person if a withdrawal or limitation is communicated. Refusing to give consent or revoking it does not then give probable cause where none existed before. You cannot use the legitimate claim of a constitutional right to infer guilt or that the person must be hiding something.

Even where consent is obtained, if any other information is solicited from one suspected of an offense, proper Article 31 warnings and, in most cases, counsel warnings must be given.

As previously noted, we use the term *control* over property rather than ownership. For instance, if Seaman Frost occupies a residence with her male companion, John Doe, John can consent to a search of the residence. Suppose, however, that Seaman Frost keeps a large tin box at the residence to which John is not allowed access. The box would not be subject to a search based upon John's consent. He could only consent to a search of those places or areas where Seaman Frost has given him control. Likewise, if Seaman Frost maintained her own private room within the residence, and John was not permitted access to the room by her, John could not give consent for a search of that room.

Stop and Frisk

Although most often associated with civilian police officers, this type of limited seizure of the person is specifically included in MRE 314(f). It does not require probable cause to be lawful and is most often used in situations where an experienced officer, chief petty officer, or petty officer is confronted with circumstances that just do not seem right. This articulable suspicion allows the law enforcement officer to detain an individual to ask for identification and an explanation of the observed circumstances. This is the stop portion of the intrusion. Should the person who orders the stop have reasonable grounds to fear for his or her safety, a limited frisk or pat down of the outer garments of the person stopped is permitted to find out whether a weapon is present. If any weapon is discovered in this pat down, its seizure can provide probable cause for apprehension and a later search incident thereto. There is, however, no right to frisk or pat down a suspect in situations where no apprehension of personal danger is involved, nor

can the frisk be conducted in a more than cursory manner to ensure safety. Further, any detention must be brief and related to the original suspicion that underlies the stop.

Searches Incident to Lawful Apprehension

A search of an individual's person, of the clothing he or she is wearing, and of the places into which he or she could reach to obtain a weapon or destroy evidence is a lawful search if conducted incident to a lawful apprehension of that individual and pursuant to MRE 314(g).

Apprehension is the taking into custody of a person. This means the imposition of physical restraint and is substantially the same as civilian arrest. It differs from military arrest, which is merely the imposition of moral restraint.

A *search* incident to a lawful apprehension will be lawful if the apprehension is based upon probable cause. This means the apprehending official is aware of facts and circumstances that would justify a reasonable person to conclude that an offense had been or is being committed and the person to be apprehended committed or is committing the offense.

The concept of probable cause as it relates to apprehension differs somewhat from that associated with probable cause to search. Instead of concerning oneself with the location of evidence, the second inquiry concerns the actual perpetrator of the offense.

An apprehension may not be used as a subterfuge to conduct an otherwise unlawful search. Furthermore, only the person apprehended and the immediate area where that person could easily obtain a weapon or destroy evidence may be searched. For example, a locked suitcase next to the person apprehended may not be searched incident to the apprehension, but it may be seized and held pending authorization for a search based on probable cause.

Until recently, the extent to which an automobile might be searched incident to the apprehension of the driver or passengers therein was unsettled. In 1981, however, the U.S. Supreme Court firmly established the lawful scope of such apprehension searches. The court held that when a law enforcement officer lawfully apprehends the occupants of an automobile, the officer may conduct a search of the entire passenger compartment, including a locked glove compartment, and any containers found therein, whether opened or closed.

Decisions of the U.S. Supreme Court have further limited the scope of a search incident to apprehension where the suspect possesses a briefcase, duffel bag, footlocker, suitcase, and so on. If it is shown that the object carried or possessed by a suspect was searched incident to the apprehension (that is, at the same time as the apprehension), then the search of that item is likely to be upheld. If, however, the suspect is taken away to be interrogated in room 1 and the suitcase is taken to room 2, a search of the item would not be incident to the apprehension, since it is outside the reach of the suspect. Here, search authorization would be required.

Emergency Searches to Save Life or for Related Purposes

In emergency situations, MRE 314(i) permits searches to be conducted to save lives or for related purposes. The search may be performed in an effort to render immediate medical aid, to obtain information that will assist in the rendering of such aid, or to prevent immediate or ongoing personal injury. Such a search must be conducted in good faith and may not be a subterfuge to circumvent an individual's Fourth Amendment protections.

Plain View Searches

When a Government official is in a place where he or she has a lawful right to be, whether by invitation or official duty, evidence of a crime observed in plain view may be seized, according to MRE 316. An often repeated example of this type of lawful seizure arises during a wall locker inspection. While the searcher is looking at the uniforms of a certain service member, a bag of marijuana falls to the deck. Its seizure as contraband is justifiable under those circumstances, as having been observed in plain view. Another situation could arise while a searcher is carrying out a duly authorized search for stolen property and comes upon a gun in the search area; since the gun is contraband, it is both seizable and admissible in court-martial proceedings.

Body Views and Intrusions

Under certain circumstances defined in MRE 312, evidence that is the result of a body view or intrusion will be admissible at court-martial. There are also situations where such body views and intrusions may be performed in a nonconsensual manner and still be admissible.

Visual examination of the unclothed body may be made with the consent of the individual subject to the inspection. An involuntary display of the unclothed body, including a visual examination of body cavities, may be required only if conducted in reasonable fashion and authorized under the following provisions of the Military Rules of Evidence:

- Inspections and inventories under MRE 313
- Searched under MRE 314(b) and 314(c) if there is a reasonable suspicion that weapons, contraband, or evidence of a crime is concealed on the body of the person to be searched
- Searched within jails and similar facilities under MRE 314(h) if reasonably necessary to maintain the security of the institution or its personnel
- Searched incident to lawful apprehension under MRE 315

An examination of the unclothed body under this rule should be conducted whenever practical by a person of the same sex as the person being examined; failure to comply with this requirement does not make an examination an unlawful search within the meaning of MRE 311.

A reasonable nonconsensual physical intrusion into the mouth, nose, and ears may be made when a visual examination of the body is permissible. Nonconsensual intrusions into other body cavities may be made under the following categories.

For purposes of seizure—When there is a clear indication that weapons, contraband, or other evidence of a crime is present, to remove weapons, contraband, or evidence of a crime discovered if such intrusion is made in a reasonable fashion by a person with appropriate medical qualifications.

For purposes of search—To search for weapons, contraband, or evidence of a crime if authorized by a search warrant or search authorization and conducted by a person with appropriate medical qualifications.

Notwithstanding this rule, a search under MRE 314(h) may be made without a search warrant or authorization if such search is based on a reasonable suspicion that the individual is concealing weapons, contraband, or evidence of a crime.

Extraction of bodily fluids—The nonconsensual extraction of body fluids; for example, blood, is permissible under the two following circumstances:

- Pursuant to a lawful search authorization

- Where the circumstances show a clear indication that evidence of a crime will be found and that there is reason to believe that the delay required to seek a search authorization could result in the destruction of the evidence

Involuntary extraction of body fluids, whether conducted pursuant to either situation mentioned previously, must be done in a reasonable fashion by a person with the appropriate medical qualifications. (It is likely that physical extraction of a urine sample would be considered a violation of constitutional due process, even if based on an otherwise lawful search authorization.) Note that an order to provide a urine sample through normal elimination, as in the typical urinalysis inspection, is not an extraction and need not be conducted by medical personnel.

Intrusions for valid medical purposes—The military may take whatever actions are necessary to preserve the health of a service member. Thus, evidence or contraband obtained from an examination or intrusion conducted for a valid medical purpose may be seized and will be admissible at a court-martial.

THE USE OF DRUG-DETECTOR DOGS

LEARNING OBJECTIVES: Describe some of the considerations and requirements when using drug-detector dogs.

Military working dogs can be used as drug-detector dogs. As such, they can be used to assist in the obtaining of evidence for use in courts-martial. Some of the ways they can be used include their use in gate searches or other inspections under MRE 313 and to establish the probable cause necessary for a later search.

One situation where the use of the dog was considered permissible was during a gate search conducted on an overseas installation. The dog's alert was used to establish probable cause to apprehend the accused. All evidence obtained was held to be admissible. Recently, the Court of Military Appeals held that the use of detector dogs at gate searches in the United States was also reasonable.

In another case, the Court of Military Appeals permitted a detector dog to be brought to an automobile believed to contain marijuana. The dog alerted on the car's rear wheels and exterior, and that prompted the police to detain the accused. The proper

commander was then notified of this alert and of other circumstances surrounding the case. The search of the vehicle was then conducted pursuant to the authorization of the commander.

The court held that the use of the marijuana dog in an area surrounding the car was lawful. The mere act of monitoring airspace surrounding the vehicle did not involve an intrusion into an area of privacy. Thus, the dog's alert was not a search, but a fact that could be relayed to the proper commander for a determination of probable cause. The Supreme Court has also held that using a dog in a common area to sniff a closed suitcase is not a search at all.

Close attention must be given to establishing the reliability of the informers in this situation; for example, the dog and dog-handler. The drug-detector dog is simply an informant. As in the usual informant situation, there must be a showing of the dog's alert and the dog's reliability. This reliability may be determined by the CO through either of two commonly used methods. The first method is for the CO to observe the accuracy of a particular dog's alert in a controlled situation. The second method is for the CO to review the record of the particular dog's previous performance in actual cases. Although either of these methods may be sufficient by itself for a determination that a dog is reliable, both should be used whenever practical. For more information on the use of military working dogs as drug detectors and establishing their reliability as such, see the *Military Working Dog Manual*, OPNAVINST 5585.2.

A few words of caution about the use of drug dogs. One court has stated that a military commander who participates in an inspection involving the use of detector dogs in the command area cannot later authorize a search based upon later alerts by the same dogs during that use. This illustrates the point that any person swept into the evidence-gathering process may find it impossible later to be considered an impartial official. The provisions of the Military Rules of Evidence are geared to lessen the effect in this type of case, in that mere presence at the scene is not per se disqualifying; but again, the line is difficult to draw.

In summary, the use of dogs for the purpose of ferreting out drugs or contraband that threatens military security and performance is reasonable means to provide probable cause when

- the dog alerts in a common area such as a barracks or passageway, or

- the dog alerts on the airspace extending from an area where there is an expectation of privacy.

INSPECTIONS AND INVENTORIES

LEARNING OBJECTIVES: Explain the general considerations regarding inspections, and list some of the requirements for inventories.

Although not within either category of searches (prior authorization or without prior authorization), administrative inspections and inventories conducted by Government agents may yield evidence admissible in trials by court-martial. MRE 313 codifies the law of military inspections and inventories. Some traditional terms that were formerly used to describe various inspections; for example, shakedown search, have been abandoned as being confusing. If carried out lawfully, inspections and inventories are not designed to be quests for evidence and thus are not searches in the strictest sense. It follows, then, that items of evidence found during these inspections are admissible in court-martial proceedings. If inspections or inventories are primarily a quest for evidence directed at certain individuals or groups, the inspection is actually a search, and evidence seized will not be admissible.

INSPECTIONS

MRE 313(b) defines *inspection as an* “examination . . . conducted as an incident of command the primary purpose of which is to determine and to ensure the security, military fitness, or good order and discipline of the unit, organization, installation, vessel, aircraft, or vehicle.” Thus, an inspection is conducted to make sure mission readiness is part of the inherent duties and responsibilities of those in the military chain of command. Because inspections are intended to discover, correct, and deter conditions detrimental to military efficiency and safety, they are considered necessary to the existence of any effective armed force and inherent in the very concept of a military organization.

MRE 313(b) makes it clear that “an examination made for the primary purpose of obtaining evidence for use in a trial by court-martial or in other disciplinary proceedings is not an inspection within the meaning of this rule.” An otherwise valid inspection is not rendered invalid solely because the

inspector has as his or her secondary purpose that of obtaining evidence for use in a trial by court-martial or in other disciplinary proceedings.

For example, assume Captain Jones suspects Seaman Doe of possessing marijuana because of an anonymous tip received by telephone. Captain Jones cannot proceed to Seaman Doe’s locker and inspect it because what he would really be doing is searching it—looking for the marijuana. How about an inspection of all lockers in Seaman Doe’s wing of the barracks? That would afford Captain Jones an opportunity to get into Seaman Doe’s locker on a pretext. And note that this is not a lawful probable-cause search because the captain has no underlying facts and circumstances from which to conclude that the informer is reliable or that his or her information is believable.

Suppose, however, that Captain Jones, having no information concerning Seaman Doe, is seeking to remove contraband from his command, prevent removal of Government property, and reduce drug trafficking. He establishes inspections at the gate. Those entering and leaving through the gate have their persons and vehicles inspected on a random basis. Captain Jones is not trying to get goods on Seaman Doe or any other particular individual. Seaman Doe carries marijuana through the gate and is inspected. The inspection is a reasonable one; the trunk of the vehicle, under its seats, and Seaman Doe’s pockets are checked. Marijuana is discovered in Seaman Doe’s trunk. The marijuana was discovered incident to the inspection. Seaman Doe was not singled out and inspected as a suspect. Here, the purpose was not to get Seaman Doe, but merely to deter the flow of drugs or the contraband. The evidence would be admissible.

An inspection may be made of the whole or any part of a unit, organization, installation, vessel, aircraft, or vehicle. Inspections are quantitative examinations because they do not single out specific individuals or very small groups of individuals. There is, however, no legal requirement that the entirety of a unit or organization be inspected. An inspection should be totally exhaustive (for example, every individual of the chosen component is inspected) or it should be done on a random basis, by inspecting individuals according to some rule of chance. Such procedures will be an effective means to avoid challenges based on grounds that the inspection was a subterfuge for a search. Unless authority to so do has been withheld by competent superior authority, any individual placed in a command or appropriate

supervisory position may inspect the personnel and property within his or her control.

An inspection also includes an examination to locate and confiscate unlawful weapons and other contraband. *Contraband* is defined as “material the possession of which is by its very nature unlawful.” Material may be declared to be unlawful by appropriate statute, regulation, or order. For example, liquor is prohibited aboard ship and would be contraband if found in Seaman Doe’s seabag aboard ship, although it might not be contraband if found in Seaman Jones’ BEQ room.

MRE 313(b) indicates that certain classes of contraband inspections are especially likely to be subterfuge searches and thus not inspections at all. If the contraband inspection (1) occurs immediately after a report of some specific offense in the unit and was not previously scheduled; (2) singles out specific individuals for inspection; or (3) inspects some people substantially more thoroughly than others, then the Government must prove that the inspection was not actually a subterfuge search.

As a practical matter, the rule expresses a clear preference for previously scheduled contraband inspections. Such scheduling helps make sure the inspection is a routine command function and not an excuse to search specific persons or places for evidence of a crime. The inspection should be scheduled sufficiently far enough in advance to eliminate any reasonable chance that the inspection is being used as a subterfuge. Such scheduling may be made as a matter of date or event. In other words, inspections may be scheduled to take place on any specific date, or on the occurrence of a specific event beyond the usual control of the commander. The previously scheduled inspection, however, need not be preannounced.

MRE 313(b) permits a person acting as an inspector to use any reasonable natural or technological aid in conducting an inspection. The marijuana detection dog, for instance, is a natural aid that may be used to assist an inspector in more accurately discovering marijuana during an inspection of a unit for marijuana. If the dog should alert on an area that is not within the scope of the inspection, however, that area may not be searched without a prior authorization. Also, where the CO is conducting the inspection when the dog alerts, he or she should not authorize the search himself or herself, but should seek authorization from some other competent authority.

INVENTORIES

MRE 313(c) codifies case law by recognizing that evidence seized during a bona fide inventory is admissible. The rationale behind this exception to the usual probable-cause requirement is that such an inventory is not prosecutorial in nature and is a reasonable intrusion. Commands may inventory the personal effects of members who are on an unauthorized absence, placed in pretrial confinement, or hospitalized. Contraband or evidence incidentally found during such a legitimate inventory will be admissible in a later criminal proceeding. However, an inventory may not be used as a subterfuge for a search.

DRUG ABUSE DETECTION

LEARNING OBJECTIVES: Describe the Navy’s urinalysis program and the types of tests given. Explain the uses of urinalysis tests.

Not in My Navy and Zero Tolerance are the Navy’s call to arms in the war on drugs. These statements reflect our commitment to the elimination of illicit drugs and drug abusers from the Naval Establishment and the continued emphasis placed on deterrence, leadership, and expeditious action. While the options available to commanders in combating drug abuse are many and varied, this section deals only with the Urinalysis Program and its limitations.

THE URINALYSIS PROGRAM

The Urinalysis Program of the Navy was established to provide a means for the detection of drug abuse and to serve as a deterrent against drug abuse. OPNAVINST 5350.4 contains guidelines on alcohol and drug abuse prevention and control. Additional guidance is found in the MRE. These rules and directives contain detailed guidelines for the collection, analysis, and use of urine samples.

The positive results of a urinalysis test may be used for a number of distinct purposes, depending on how the original sample was obtained. Therefore, it is important to be able to recognize when, and under what circumstances, a command may conduct a proper urinalysis.

TYPES OF TESTS

OPNAVINST 5350.4 directs that commanders, COs, and OICs should conduct an aggressive urinalysis testing program, adapted as necessary to meet unique unit and local situations. The specific types of urinalysis testing and authority to conduct them are described in the following paragraphs.

SEARCH AND SEIZURE

Members suspected of having unlawfully used drugs may be requested to consent to urinalysis testing. For consent to be valid, it must be voluntarily given. In this regard, OPNAVINST 5350.4 provides that, before requesting consent, commands should advise the member that he or she is “suspected of drug

use and may decline to provide a sample.” A recommended urinalysis consent form is shown in figure 3-3.

- Probable cause and authorization. Urinalysis testing may be ordered, according to MRE 312(d) and 315, whenever there is probable cause to believe that a member has wrongfully used drugs and that a test will produce evidence of such use. For example, during a routine locker inspection in the enlisted barracks, you find an open bag of what appears to be marijuana under some clothes in Petty Officer Frost’s wall locker. Along with the marijuana you find a roach clip and some rolling papers. You notify the CO of your findings and the CO sends for Frost. A few minutes later, Frost staggers into the CO’s office—eyes red and speech slurred—Frost is immediately apprehended and

URINALYSIS CONSENT FORM

I, _____, having been requested to provide a urine sample, have been advised that:

- (1) I am suspected of having unlawfully used drugs;
- (2) I may decline to consent to provide a sample of my urine for testing;
- (3) If a sample is provided, any evidence of drug use resulting from urinalysis testing may be used against me in a court-martial.

I consent to providing a sample of my urine. This consent is given freely and voluntarily by me, and without any promises or threats having been made to me or pressure or coercion of any kind having been used against me.

Signature

Date

Witness' signature

Date

Figure 3-3.—Urinalysis consent form.

searched. A marijuana cigarette is found in his shirt pocket. Under these facts, a commander would have little trouble finding probable cause to order that a urine sample be given.

- Probable cause and exigency. MRE 315 recognizes that there may not always be sufficient time or means available to communicate with a person empowered to authorize a search before the evidence is lost or destroyed. This lack of time is most commonly seen in the operable vehicle setting, and facts could easily give rise to support an exigency search of a member's body fluids. Remember, to be lawful, an exigency search must still be based upon a finding of probable cause.

URINALYSIS INSPECTIONS UNDER MRE 313

Commanders may order urinalysis inspections, just as they may order any other inspection, to determine and make sure of the security, military fitness, and good order and discipline of the command. Urinalysis inspections may be ordered for the primary purpose of obtaining evidence for trial by court-martial or for other disciplinary purposes would defeat the purpose of an inspection and make it a search. Commands may use a number of methods of selecting service members or groups of members for urinalysis inspection, including (but not limited to) the following:

- Random selection of individual service members from the entire unit or from an identifiable segment or class of that unit. Random selection is achieved by making sure each service member has an equal chance of being selected each time personnel are chosen,

- Selection, random or otherwise, of an entire subunit or identifiable segment of a command. Examples of such groups include an entire department, division, or watch section; all personnel within specific paygrades; all newly reporting personnel; or all personnel returning from leave, liberty, or unauthorized absence (UA).

- Urinalysis testing of an entire unit. As a means of quota control, Navy commands are required to obtain second-echelon approval before conducting all unit sweeps and random inspections involving more than 20 percent of a unit, or 200 members. Failure to obtain such approval, however, will not invalidate the results of the testing.

SERVICE-DIRECTED TESTING

Service-directed testing is actually nothing more than inspections of units expressly designated by the Chief of Naval Operations (CNO). These include rehabilitation facility staff; security personnel; A school candidates; officers and enlisted in the accession pipeline; and those executing permanent change of station (PCS) orders to an overseas duty station.

VALID MEDICAL PURPOSES

Urinalyses and blood tests also may be performed to assist in the rendering of medical treatment (for example, emergency care, periodic physical examinations, and such other medical examinations as are necessary for diagnosis or treatment). Do not confuse this with a fitness-for-duty examination ordered by a service member's command.

FITNESS-FOR-DUTY TESTING

Categories of fitness-for-duty urinalysis testing are briefly described as follows. Generally, all urinalyses not the product of a lawful search and seizure, inspection, or valid medical purpose fall within the fitness-for-duty/command-directed categories.

- Command-directed testing. A command-directed test will be ordered by a member's CO or OIC, or other authorized individual, whenever the member's behavior, conduct, or involvement in an accident or other incident gives rise to a reasonable suspicion of drug abuse and a urinalysis has not been conducted on a probable cause or *con sensual* basis. Command-directed tests are often ordered when suspicious or bizarre behavior does not amount to probable cause.

- Aftercare and surveillance testing. *Aftercare testing* is periodic command-directed testing of identified drug abusers as part of a plan for continuing recovery following a rehabilitation program. *Surveillance testing* is periodic command-directed testing of identified drug abusers who do not participate in a rehabilitation program, as a means of monitoring for further drug abuse.

- Evaluation testing. This refers to command-directed testing when a commander has doubt as to the member's wrongful use of drugs following a laboratory-confirmed urinalysis result. Evaluation testing should be conducted twice a week for a maximum of 8

weeks and is often referred to as a two-by-eight evaluation.

- Safety investigation testing. A CO or any investigating officer may order urinalysis testing in connection with any formally convened mishap or safety investigation.

USES OF URINALYSIS RESULTS

Of particular importance to the command is what use may be made of a positive urinalysis. The results of a lawful search and seizure, inspection, or a valid medical purpose may be used to refer a member to a Department of Defense (DOD) treatment and rehabilitation program, to take appropriate disciplinary action, or to establish the basis for a separation and for characterization in a separation proceeding.

The results of a command-directed/fitness-for-duty urinalysis may not be used against the member for any disciplinary purposes or on the issue of characterization of service in separation proceedings except when used for impeachment or rebuttal in any proceeding that evidence of drug abuse has been first introduced by the member. In addition, positive results obtained from a command-directed fitness-for-duty urinalysis may not be used as a basis for vacation of a suspension of punishment imposed under Article 15, UCMJ, or a result of court-martial. Such results may, however, serve as the basis for referral of a member to a DOD treatment and rehabilitation program and as a basis for administrative separation.

What administrative or disciplinary action can be taken against service members identified as drug

abusers through service-directed urinalysis testing varies, depending upon which CNO-designated unit was tested. The only constant is that all service-directed testing may be considered as the basis for administrative separation.

THE COLLECTION PROCESS

The weakest link in the urinalysis program chain is in the area of collection and custody procedures. Commands should conduct every urinalysis with the full expectation that administrative or disciplinary action might result. The use of chiefs and officers as observers and unit coordinators is strongly encouraged. Strict adherence to direct observation policy during urine collection to prevent substitution, dilution, or adulteration is an absolute necessity. All samples should be mailed immediately after collection to reduce the possibility of tampering. Make sure all documentation and labels are legible and complete. Special attention should be given to the ledger and chain of custody to make sure they are all accurate, complete, and legible. Additional guidance is provided in OPNAVINST 53530.4.

SUMMARY

In this chapter, we examined the sources of the law of search and seizure and some of the language used. Next we covered the categories of evidence and searches. The use of drug-detector dogs, requirements for inspections and inventories, and the Navy's urinalysis program were also considered.

CHAPTER 4

MILITARY LAW OF EVIDENCE

Acting much like a filter, the law of evidence operates to separate that evidence or information which is worthy of being placed before the triers of fact from information which has no place before these jurors. Obviously, this is a gross oversimplification, but it conveys the basic idea underlying the law of evidence.

—*Basic Military Justice Handbook*

The material discussed in this manual does not cover all the laws of evidence. The laws covered in this chapter are those needed to help you prepare a case and to make you aware of what to expect when a case goes to trial.

SOURCES OF THE LAW OF EVIDENCE

LEARNING OBJECTIVES: Identify and discuss the various sources for the law of evidence.

When speaking of “the law of evidence,” one does not refer to a single set of laws contained in a particular book. Some of the major sources of the law of evidence are the Constitution, statutes, court rules, court decisions, scholarly writings, and administrative decisions.

THE CONSTITUTION

The chief focal point of our discussion of the law of evidence is its application in the military. Since the Navy is an arm of the Federal Government, the basic source for evidentiary law is, as expected, the U.S. Constitution.

Article I, Section 8 of the Constitution states: “The Congress shall have power. . . to make rules for the Government and regulation of the land and naval forces. . . .” For anyone familiar with the Constitution, this might seem odd, since Article III addresses itself to the judiciary. But military courts are Article I courts—not Article III courts. In other words, military courts derive their existence, at least indirectly, from Article I of the Constitution, whereas a Federal

District court, which might try a criminal case, derives its power from Article III of the Constitution.

THE UNIFORM CODE OF MILITARY JUSTICE

Congress enacted the *Uniform Code of Military Justice (UCMJ)* Under Article I, Section 8 of the Constitution. The *UCMJ* contains a number of articles dealing with evidentiary matters, but Article 36 is the key to the military law of evidence. Article 36 of the *UCMJ* vests the President of the United States with the power to prescribe rules of evidence for the Armed Forces.

THE MANUAL FOR COURTS MARTIAL

The President has prescribed the rules of evidence in the *Manual for Courts-Martial (MCM)*. Change 5 is the latest revision to the *MCM*, issued in November 1991. This is the most significant change concerning the rules of evidence. It adopts a new body of rules similar to the Federal Rules of Evidence. These new rules, called Military Rules of Evidence (MRE), are found in Chapter 27 of the *MCM*. They have long been the primary source of evidentiary rules in the military. Although the bulk of evidentiary rules are set forth in Chapter 27, other chapters of the *MCM* also deal with matters related to the law of evidence.

The *MCM* may not be able to interpret each point of the law relating to evidence. Such interpretation is a continuing process. Therefore, the Courts of Military Review (CMR) and Court of Military Appeals (COMA) were established to interpret points of law on particular issues. In effect, then, they have the function of making new law through their interpretation of existing law. If a point of law is not covered in the *MCM*, or if it is not clear, in many instances military trial courts will be able to refer to the decisions of the CMR or COMA. Therefore, in addition to the *MCM*, the military judicial system itself is a source of the law of evidence.

OTHER SOURCES

Finally, other sources of the law of evidence are to be found in Federal Court decisions interpreting rules of evidence; opinions of the Judge Advocate General; various administrative publications such as *Navy Regulations*, the *Manual of the Judge Advocate General of the Navy*, the *Naval Military Personnel Manual*, and various orders and instructions; the decisions of State courts; and scholarly works on evidence.

APPLICABILITY OF THE RULES OF EVIDENCE

LEARNING OBJECTIVES: Explain how the rules of evidence apply at trial and in nonjudicial punishment proceedings.

In a trial, the rules of evidence may well determine whether or not the accused is convicted or acquitted. Without the rules of evidence, the outcome of trials would be inconsistent and the courtroom in chaos. Thus, these rules, which some choose to call “technicalities,” are necessary for fairness, both to the government and to the accused.

The Military Rules of Evidence (MRE) do not apply to proceedings conducted under Article 15, *UCMJ*. However, paragraph 133b(3) of the MCM requires that the accused be advised of his or her rights against self-incrimination (Art. 31b) at mast or office hours. Although the MRE do not apply in nonjudicial punishment proceedings, the commanding officer should be assured that the information that provides the basis for imposition of nonjudicial punishment is reliable. But rule 101 of the Military Rules of Evidence does make the rules applicable to general, special, and summary courts-martial.

The purpose of a trial is to decide the “ultimate issue”; that is, the innocence or guilt of the accused with regard to particular charges and specifications. To resolve this issue, the government has the burden of proving the accused’s guilt beyond a reasonable doubt by the introduction of facts.

Besides the ultimate issue of guilt or innocence, there are other issues that will arise at trial. For example, one right of the accused is to have access to the files of the government that pertain to his or her case. The law of evidence operates to guarantee that this right is observed. If the government has not

allowed the defense to examine these files, the government may be prevented from introducing this information at trial.

Thus, without the law of evidence, the criminal trial as we know it would be a very disorderly proceeding. Without it, information received at trial would be unreliable, and many of the rights afforded an accused in a criminal proceeding would be denied.

POINTS OF INTEREST

LEARNING OBJECTIVES: Describe the two major points of interest in a case. Define corpus delicti. Explain how intent, drunkenness, and negligence may affect the outcome of a trial. Describe the concept of presumption of innocence.

In every court proceeding, the prosecution must produce evidence to prove the following two major points, which constitute the issue in a case:

1. The offense charged was actually committed.
2. The person accused committed the illegal act.

Certain other elements also must be proven in some cases. For example, consider a case of larceny in which the accused is charged with stealing certain personal goods of value. The other element that must be proven is that the articles were taken fraudulently with the intent to permanently deprive the owner of possession.

CORPUS DELICTI

A consideration of the meaning of *corpus delicti* becomes necessary at this point, because some people usually think of a murder victim when anyone uses this term. A commonly accepted definition of *corpus delicti* is “the body or substance of a crime.” As the term is used and understood today, this definition is not accurate. The definition has a broader meaning. *Corpus delicti* is applicable to the substantial and fundamental fact or facts connected with the actual commission of an illegal act (civil or criminal). For example, in the theft of a watch, the corpus delicti is the taking of the watch.

Usually the corpus delicti is proven by the prosecution at the start of a case, because without it, there is no offense. In certain instances, courts permit changes in the normal sequence in which evidence is introduced. Notwithstanding such a change in

procedure, the prosecution must always prove that the accused is the same person named in the indictment, charges and specifications. Usually the requisite proof is afforded by the testimony of people who know the accused. Next, the prosecution must prove, with the testimony of the witnesses, that the accused committed the crime.

INTENT

In some crimes, intent must be proven as a separate fact apart from the crime. Such crimes are murder, larceny, burglary, desertion, mutiny, and the like. In certain other crimes, the law holds that the crime itself shows intent existed. In this group are rape, sleeping on watch, drunkenness, neglect of duty, and so on.

DRUNKENNESS

Drunkenness may be admitted for consideration if it tends to show a mental or physical incapacity on the part of a person to plan or carry out a specific intent to commit an offense. The nature of some crimes is such that deliberate intent and careful planning may be beyond the ability of a person who is drunk. Such crimes are larceny, robbery, and burglary. For instance, a drunk person charged with robbery might have the charge reduced to one less serious, such as battery or trespassing. Similarly, in a murder case, proof of drunkenness might reduce the crime to manslaughter. Proof of drunkenness at the time the crime was committed may be introduced not to excuse or lessen the seriousness of the homicide, but to aid the court in deciding whether the accused is guilty of the crime charged or of one less serious in nature.

On the other hand, a statute may be so framed as to make the act of rape, assault and battery, or arson criminal, whether or not there was intent to break the law. Evidence that the accused was drunk would not, therefore, constitute a defense for the commission of any of these acts.

NEGLIGENCE

If a man kills another, proof of negligence may be sufficient to support a conviction without regard to intent. To avoid criminal responsibility, such a person must have used the same care and caution that a man of ordinary foresight would have used under similar conditions. The courts are very strict in interpreting what constitutes ordinary caution, particularly in regard to firearms.

PRESUMPTION OF INNOCENCE

The law presumes the accused is innocent until he or she is proven guilty. In a civil action, the plaintiff must prove his or her case by a preponderance of the evidence; whereas in a criminal case, his or her guilt must be proven beyond a reasonable doubt. The burden of proving a case (recovery or a ground of defense) is upon the person who makes the accusation and takes action to introduce the matter for trial before a judicial tribunal. The burden of proof remains to the end of the case with the party who has it at the beginning of the trial. The accused is never required to assume the burden of proof to show innocence. In minor issues, however, such as when the accused objects to the testimony introduced by the prosecution, the accused must assume the burden of proving that his or her objection is valid.

FORMS OF EVIDENCE

LEARNING OBJECTIVES: List and explain the three basic forms of evidence. Define demonstrative evidence.

Evidence can be divided into at least three basic forms: oral, documentary, and real. A special form of evidence called demonstrative will also be discussed in this section.

ORAL EVIDENCE

Oral evidence is the sworn testimony received at trial. The fact that an oath is administered is some guarantee that the information related by the witness will be trustworthy. If the witness makes statements under oath that are not true, he or she may be prosecuted for perjury. There are, however, other forms of oral evidence. For example, if a witness makes a gesture or assumes a position to convey information, this, too, is a form of oral evidence from the standpoint of a broad definition of the term. Generally, witnesses will be able to relate what they actually observed, heard, smelled, felt, or experienced, either through oral testimony or by acting out what they know as a result of their sensory perceptions.

DOCUMENTARY EVIDENCE

Documentary evidence is usually a writing that is offered into evidence. For example, an accused is

charged with making a false report. The government, to prove its case, would want to introduce the report in evidence. Another example could be when a servicemember is absent from his or her command. To prove that he or she was absent, the government would introduce an entry from the accused's service record as proof of this fact.

Documentary evidence includes letters, telegrams, printed matter, photographs, charts, and the like. It must be both material and relevant, and its use is governed by certain rules, as pointed out in the next three topics.

General Requirements for Documentary Evidence

The following is a listing of general requirements for documentary evidence:

1. The genuineness of every document must be proven. Authentication of a writing maybe provided by having its author appear as a witness, calling a witness who was present when it was signed, or calling one who can identify the handwriting.

2. In proving the contents of a writing, the original of the writing is the best evidence of its contents and must, therefore, be introduced (except in certain situations). When an admissible writing has been lost or destroyed or cannot be produced, the contents may be proven by an authenticated copy or by the testimony of a witness who has seen and can remember the writing.

3. When documentary evidence is lengthy, the court (to save time) may permit a witness who has studied the papers to attest to their meaning. The opposing party, of course, has the right to examine the documentary evidence and to cross-examine the witness.

4. Unofficial charts, sketches, diagrams, plans, notes, or drawings representing items that cannot be described clearly and easily by a witness are admissible when proven to be authentic. Proof that such a piece of evidence is a true and accurate representation is sufficient.

5. The terms of a written document cannot be altered by oral testimony. Oral testimony intended to explain the meaning of a document, however, is admissible.

6. Documentary evidence must be introduced by presenting it to the court and identifying it.

7. Official documents of the Department of Defense are assumed to be genuine.

8. A document must be offered in full. Even though only a part of it is read to the court, the entire document must be received in evidence.

9. A desired document that is not in the possession of the party wishing to introduce it may be produced in court by serving a *subpoena* on the holder.

Records and Registers

The following rules apply to the admissibility of records and registers:

1. Properly authenticated copies of government records are admissible in lieu of the originals.

2. An official chart is admissible as an official record.

3. Entries and records of an organization (such as attendance reports, muster sheets, and hotel registers) are admissible, provided it is the practice of such organization to keep such records in the regular course of business.

Letters, Telegrams, and Photographs

The following rules apply to the admissibility of letters, telegrams and photographs:

1. A letter or telegram written, dictated, or signed by the accused may be submitted as evidence.

2. A letter or telegram sent to the accused is admissible only if it can be shown that he or she answered or acted upon it.

3. The original telegram filed with the sending office should be offered to the court. If the original is lost or destroyed, the received copy can be submitted.

4. Photographs and X-rays that are proven to be true pictures are admissible.

REAL EVIDENCE

Real evidence is any physical object that is offered into evidence. Real evidence includes all objects that are relevant and material to the issue, in addition to the testimony of witnesses and written documents. For example, a murder weapon, such as a pistol, would be real evidence. Now let's look at one more form of evidence, called demonstrative evidence.

DEMONSTRATIVE EVIDENCE

Demonstrative evidence is a hybrid or combination form of evidence. The old “personal view” principle has not been scrapped. This principle permits the jurors to view the scene of the act or happening, and thus obtain firsthand evidence to assist them in reaching a decision. Because of the complexity of the machinery of justice, however, the personal view becomes less and less practical. But if the court considers personal view desirable, it may adjourn to the scene of the offense.

As a means of presenting to the jury factual evidence concerning the issues, the courts today find it expedient to permit a witness to explain his or her testimony by introducing photographs, maps, models, or diagrams. The courts look upon such evidence as being more helpful in some respects than the testimony of human witnesses.

Evidence in this form, partly documentary and partly real, is called demonstrative evidence and is frequently categorized separately from the three basic forms of evidence.

TYPES OF EVIDENCE

LEARNING OBJECTIVES: List and explain the two types of evidence. Determine when circumstantial evidence is admissible and when it is inadmissible.

At trial, any form of evidence may be introduced to prove or disprove a fact either directly or circumstantially. We will now consider evidence known as *direct evidence* and *circumstantial evidence*. These two types of evidence may take any of the forms already discussed.

DIRECT EVIDENCE

Direct evidence is evidence that applies directly, without referring to other inferences, to prove or disprove a fact in issue. For example, a confession from the accused that he or she perpetrated the alleged offense is direct evidence that he or she did it.

CIRCUMSTANTIAL EVIDENCE

Circumstantial evidence, on the other hand, is evidence that tends to establish a fact from which a fact in issue may be inferred. For example, a pistol

found at the scene of the crime and inscribed with the name “Able B. Seaman” is only circumstantial evidence that he was ever at the scene or that the pistol is his. The pistol may not belong to Able B. Seaman; or if the pistol is his, it may have been lost or stolen.

Circumstantial evidence is **NOT** inherently inferior to direct evidence. If the trier of fact is convinced of the accused’s guilt beyond a reasonable doubt, the fact that all evidence was circumstantial will not dictate an acquittal.

Admissible Circumstantial Evidence

The following case illustrates competent circumstantial evidence that would be acceptable by a court. SN Jack R. Frost is charged with stealing clothes from the locker of QM3 Pistol.

1. The clothes were taken while Pistol was at drill. No one was seen near his locker.
2. Because Frost was detailed as a foodhandler, he was not at drill. For a short while, however, he was absent from his duty as foodhandler, during which period the clothes disappeared.
3. Frost was known to be without money the day before the theft occurred. That evening he left the barracks with a bundle under his arm, and later was seen to enter a certain house. Later the same night, he had money in his possession.
4. When the house was searched the next day, most of the missing clothes were found.

Inadmissible Circumstantial Evidence

The courts would not allow the following types of circumstantial character evidence to be admitted for the purpose of proving the conduct of the accused. These examples of circumstantial evidence are inadmissible because they are unreliable. In general, this is true whether the case is civil or criminal.

- The accused is disliked by his shipmates.
- A number of thefts have occurred aboard the ship, and the general belief is that the accused was connected with them.
- He was tried before for the theft of clothes, and convicted.
- He is suspected of being a deserter from a foreign navy.

- He comes from a poor district where petty thievery is common.

ADMISSIBILITY OF EVIDENCE

LEARNING OBJECTIVES: Describe three major factors that determine the admissibility of evidence. Define prima facie evidence. Explain the concept of reasonable doubt. Determine when similar facts and other offenses are admissible at trial. Define hearsay evidence and explain two exceptions to the hearsay evidence rule.

Apart from the forms and types of evidence, certain matters will be admitted into evidence and others will not.

Admissibility depends upon several factors: (1) authenticity, (2) relevancy, and (3) competency. For evidence to be admissible, it must meet each qualification or test discussed in the following paragraphs.

AUTHENTICITY

The term *authenticity* refers to the genuine character of the evidence. Authenticity simply means that a piece of evidence is what it purports to be. Let's consider the three forms of evidence.

First, with regard to oral evidence, consider the testimony of a witness. We know that his or her testimony is what it purports to be by virtue of the fact that he or she has taken an oath to tell the truth, the whole truth, and nothing but the truth. He identifies himself as John Boate, and therefore, this is John Boate's testimony.

Next, consider a piece of documentary evidence—a service record entry, for example. How do we know that the service record entry is what it purports to be? Sometimes the custodian of the record, the personnel officer, will be called to “identify” the service record entry. The personnel officer will testify under oath that he or she is the custodian of the record, that he or she has withdrawn a particular entry or page from the service record, and that the evidence is, in fact, that entry or page. Again, it is established that the service record entry is what it purports to be.

Last of all, with regard to real evidence, take, for example, a weapon that was recovered from the person of the accused as the result of a search by an MA. The

MA is called and sworn as a witness. He or she gives testimony with regard to the circumstances of the search. Finally, the MA is presented with the weapon, and identifies it, perhaps from an identifying mark on the weapon or perhaps from a tag he or she attached to the weapon at the time it was seized. His or her testimony establishes that the weapon is what it purports to be.

Testimony is not the only way to authenticate certain types of evidence. For example, in the case of documentary evidence, a certificate from the custodian may be attached to a particular piece of documentary evidence. This attesting certificate establishes that the document is what it purports to be. An attesting certificate is a certificate or statement signed by the custodian of the record. It indicates that the writing to which the certificate or statement refers is a true copy of the record. The attesting certificate also indicates that the signer of the certificate or statement is the official custodian of the record. Once it is admitted in evidence, the certificate takes the place of a witness. In effect, the certificate speaks for itself. Of course, another way to achieve authentication is to have the trial counsel and the defense counsel agree that a certain item sought to be introduced into evidence is what it purports to be. The accused must consent to the agreement. This type of agreement is called a “stipulation,” which must be accepted by the court in order for it to be effective in the case.

RELEVANCY

The term relevancy means that the information must reasonably tend to prove or disprove any matter in issue. The question or test involved is, “Does the evidence aid the court in answering the question before it?”

To understand the meaning of relevancy, consider a situation in which an accused is charged with theft of property of the United States. In most cases, the fact that the accused beat his wife regularly would probably have nothing to do with his theft of property of the United States. Therefore, any testimony to that effect would be objectionable as being irrelevant.

COMPETENCY

Competent as used to describe evidence means that the evidence is relevant and not barred by any exclusionary rule. Competent evidence is admissible as fit and appropriate proof in a particular case.

Several other considerations also determine competency. They are as follows:

Public policy. First, the evidence sought to be introduced must not be obtained contrary to public policy. The exclusionary rule is a recognition by the courts that in certain instances there is a public policy that requires the exclusion of certain evidence because of a counterbalancing need to encourage or prevent certain other activity or types of conduct. Additionally, this concept acts to further certain relationships at the expense of excluding certain evidence; for example, the husband-wife privilege precludes under certain circumstances the calling of one spouse to testify against the other. Similar privileges protect the relationships of attorney-client and clergyman-penitent. There is no such protection afforded in military law to a doctor and patient.

Reliability. A second exclusionary factor that relates to competence is reliability. Evidence that is hearsay (an out-of-court statement offered in court for the proof of its contents) is inadmissible. Hearsay evidence will be discussed later in this chapter. Exceptions to the hearsay rule are allowed only where the circumstances independently establish the reliability of the evidence. With respect to documentary evidence, the rules have been previously discussed. These rules exist with one purpose in mind: evidence that is offered must be reliable.

Undue prejudice. The third consideration with regard to competence rests in the area of undue prejudice. Here, such matters as prior convictions and inflammatory matters may not be received in evidence in order to prove or disprove an issue at trial.

Therefore, competency is a test of whether or not something is admissible; but, more than that, it is a matter of whether or not the evidence can meet the three tests outlined above—public policy, reliability, and undue prejudice.

PRIMA FACIE EVIDENCE

Prima facie evidence may be defined as “evidence that is good and sufficient, on its face, to meet the issue if no other testimony is offered.” The prosecution establishes a prima facie case by introducing enough evidence to outweigh the general presumption that the accused is innocent. A prima facie case can be overthrown only when the accused introduces sufficient evidence in rebuttal; that is, evidence that contradicts or meets the evidence of the prosecution.

You must keep in mind that a prima facie case has no effect on the burden of proof, though it satisfies that burden for the time being. In addition, it calls upon the adverse party to introduce sufficient evidence to counteract or meet the prima facie case made against an accused.

The question of the court at the end of the trial is always: “Has the prosecution proven the guilt of the accused beyond a reasonable doubt?” Notice that it is not: “Has the accused been proven innocent?”

REASONABLE DOUBT

Reasonable doubt means an honest and real doubt caused by insufficient proof. It is not a doubt caused by a fault-finding attitude. Nor is it brought on by sympathy for the accused or for the accused’s family. Proof beyond reasonable doubt is not proof beyond the possibility of mistake. The doubt must be based on reason, and it must be reasonable in view of all the evidence. If, after considering all the evidence impartially, the court feels it is dissatisfied or has an honest misgiving that the defendant is guilty, then reasonable doubt exists. To find the accused guilty, the court must be morally certain that the accused is guilty.

SIMILAR FACTS

Evidence of similar facts maybe introduced where the similarity between the facts is so close that there is practically no difference. For example, if a man is apprehended for speeding, the fact that he had been speeding on the same day a mile away would be inadmissible evidence. But evidence that he was driving at 60 miles per hour a moment before at a point very close to where he was apprehended would be admissible, because there is reasonable probability that his speed was maintained. Similarly, in a case involving drunkenness, it may be shown that the accused had been drinking shortly before the time specified, but a statement that the accused often was drunk in the past would not be admissible.

OTHER OFFENSES

Evidence of other offenses or acts of misconduct of the accused may be introduced when it tends to (1) identify the person as the perpetrator of the offense charged, (2) prove a plan or design of the accused, and (3) prove guilty knowledge or intent, if guilty knowledge or intent is an element of the offense.

For example, a man was being tried for claiming as real an imitation diamond he was pawning. Evidence that he shortly before had tried to pawn other imitation gems was admitted. This evidence is an exception to the rule that a different crime, not connected with the one alleged in the specification, cannot be brought out in evidence. Another example: A male defendant is charged with obtaining money from a female by marrying her. He obtained her money on a representation that he would invest it for her, and then he absconded. Evidence that he had pursued the same course with three other female acquaintances is admissible.

HEARSAY EVIDENCE

Hearsay testimony is secondhand evidence; it is not what the witness knows personally, but what someone else told him or her. *Scuttlebutt* is an example of hearsay. In general, hearsay may not be admitted in evidence, but there are exceptions. For instance, if the accused is charged with uttering certain words, a witness is permitted to testify that he or she heard the accused speak them.

The following examples illustrate hearsay that is inadmissible:

1. SN Water, the accused, is being tried for desertion. BMC Boate cannot testify that BM3 Christmas told him that SN Water said he (Water) intended to desert.

2. The accused is being tried for larceny of clothes from a locker. A testifies that B told him that she saw the accused leave the space where the locker was located with a bundle of clothes about the same time the clothes were stolen. This testimony from A would not be admissible to prove the facts stated by B.

Neither BMC Boate nor A would be allowed to testify, but the trial counsel could call BM3 Christmas and B as witnesses. The fact that hearsay evidence was given to an officer in the course of an official investigation does not make it admissible. Now let's look at two exceptions to the rules for hearsay evidence: dying declarations and *res gestae*.

Dying Declarations

Dying declarations of a victim that relate to facts surrounding the act that caused his or her dying condition are excepted from the hearsay rule. Such declarations are admissible in homicide cases. To be admissible as a dying declaration, the declaration must

have been made while the victim was at the end of life (extremity) or under a sense of impending death and without hope of recovery.

In most jurisdictions, if the statement is to be introduced at a trial for criminal homicide, the person making the declaration must actually have died. If that person did not die, he or she would, of course, appear as a witness. A transcript of oral evidence of the dying declaration of the victim is admissible and may be repeated in court provided it is shown that the person knew that he was dying when the declaration was made, that the statement pertained to his own homicide, and that he was competent to testify. In the trial of A for murder, for example, the statement the deceased made, a few minutes before his death, that A shot him will be held admissible.

Res Gestae

Still another exception to hearsay testimony comes under the heading of *res gestae*. *Res gestae* are involuntary exclamations or acts made at the time the offense was committed and are so closely connected to the main fact in issue as to be a part of it. These utterances or acts are not planned, but are forced from the individual by the excitement of the moment. The ground of reliability upon which such declarations are received is their spontaneity; they are the facts talking through the party.

Res gestae also cover matters of identification. If a man witnesses a killing, for example, and afterwards sees the accused and, without thought, asserts: "There's the man who did the killing," his remark would be admissible.

COURT PROCEEDINGS

LEARNING OBJECTIVES: Determine the order in which evidence is presented in court, Describe the methods used to bring witnesses to court, and who may testify in court. Define credibility of a witness. Explain disqualification and impeachment of a witness. Identify the difference between depositions and affidavits.

We will now discuss some of the court procedures that you will find helpful when preparing an investigation. A working knowledge of court proceedings will also help if you have to appear in court.

ORDER OF EVIDENCE

Evidence is introduced first by the prosecution, then by the defense. Next, the prosecution rebuts the defense evidence. In conclusion, the defense has its surrebuttal. The court, in the interest of justice, may allow new evidence to be introduced at any time before it brings in a verdict.

During the rebuttal, the prosecution may introduce evidence to explain or contradict the evidence brought forward by the defense. The evidence of defense witnesses may be impeached (its truth questioned), or the truthfulness of the prosecution witnesses may be upheld. In the surrebuttal, the defense tries to discount the evidence brought out in the rebuttal.

Witnesses always are examined separately; no witness is allowed to be present in court while another witness is testifying. This practice, of course, does not apply to the accused, the trial counsel, the defense counsel, or members of the court, should they testify. Objection to a witness on the grounds of incompetence is made before he is sworn. The court decides whether such an objection is valid. Similarly, when the opposing side objects, the court rules on the admissibility of any question asked a witness.

ATTENDANCE OF WITNESSES

The attendance of witnesses is obtained by serving them a subpoena. This method of calling witnesses applies to civilians appearing before any judicial body appointed to inquire into the truth of a matter of general interest.

Any court-martial can require any member of the Armed Forces to appear before it as a witness. If the witness is stationed near the location of the court (so that travel at government expense is unnecessary), the trial counsel customarily notifies the witness, orally or in writing, of the date and place of the trial. To assure the attendance of the witness, his or her commanding officer should be advised informally. If a formal notice is required, the trial counsel makes a request to the commanding officer of the witness to ensure his or her appearance.

If the witness is not stationed close to the location where the court-martial will convene, the commanding officer will issue orders for travel at government expense to the trial. If practicable, a request for the attendance of a military witness is made

in ample time to allow notice of at least 24 hours before the court convenes.

The trial counsel is authorized to subpoena as a witness, at government expense, a civilian in the United States or its territories and possessions, and can compel the civilian's attendance at the trial. If practicable, a subpoena is issued at least 24 hours before the time the witness must travel from home to comply with the subpoena.

The trial counsel, the defense counsel, and the court-martial are given equal opportunity to obtain witnesses. The trial counsel takes timely and appropriate action to provide for the attendance of those witnesses who have personal knowledge of the facts at issue in the case, both for the prosecution and for the defense.

WHO MAY TESTIFY?

The greater portion of the law of evidence is concerned with the rules that gradually have grown up in the courts respecting persons who may testify, and the manner in which their testimony may be given. Keep in mind that the sole objective of the rules of evidence is to arrive at the truth. A witness testifies regarding his or her knowledge of the facts as a matter of public duty, and only with the imposition of conditions the law authorizes. An example of an unauthorized condition would be an agreement to pay a witness additional compensation exceeding that authorized by law for his or her testimony.

Accused and Accomplice

The accused is allowed to testify if he or she desires. But the accused can never be forced to testify. If the accused elects not to take the witness stand, no comment may be made on this fact. The Constitution provides that no one may be compelled to testify against himself or herself.

An accomplice is always competent to testify although he or she cannot be required to answer questions when the answers might be incriminating. When an accused or accomplice testifies, the court, when deciding the creditability of the testimony, will carefully consider the evidence given.

Counsel

The trial counsel or the counsel for the accused may testify when his or her testimony is desired.

Children

The admissibility of testimony from a child is governed not by the child's age but by the child's sense and understanding of the facts and by his or her understanding of the importance of telling the truth.

Husband and Wife

The rules governing certain restrictions on the testimony of husband and wife are as follows:

1. The wife or husband of an accused may testify for the accused without restriction, but the witness may be cross-examined by the trial counsel.
2. The wife or husband of an accused may not be called to testify against the accused without the consent of both the accused and the witness unless the offense was committed by the accused against the witness.
3. A wife or husband may not testify to confidential communications received from the other unless the other gives consent.

CREDIBILITY OF A WITNESS

The *credibility of a witness* is his or her worthiness of belief, determined by the following considerations: Character, acuteness of powers of observation, accuracy and retentiveness of memory, general manner in giving evidence, relation to the matter before the court, appearance, deportment, and prejudices, general reputation for truth in his or her community, a comparison of his or her testimony with other statements made by him or her out of court, and a comparison of his or her testimony with that of others.

The creditivity of a witness may be attacked in cross-examination, or by evidence, to show that the witness has a bad reputation for truthfulness. Evidence that he or she was convicted in court of a crime involving moral turpitude and, particularly, perjury may be admitted. Testimony may be introduced to the effect that the witness has a bad reputation for truthfulness in his or her community or place of employment, and his or her reputation is considered to be a matter of fact. Testimony concerning his or her character is not allowed, because the law holds that this is a matter of opinion.

DISQUALIFICATION OF A WITNESS

Insanity or intoxication may disqualify a witness insofar as such condition affects the validity of the testimony. A witness proven senseless with drink at the time of the happening for which testimony is desired is barred on the grounds of intoxication. A witness suffering from mental infirmity is nevertheless competent to testify if the witness understands the moral importance of telling the truth and has the mental capacity to observe, remember, and describe accurately the facts under inquiry. The court (judge or law officer) decides whether a witness is competent to testify.

IMPEACHING A WITNESS

The testimony of a witness may be impeached in any of three ways:

- The facts to which the witness testifies may be disproved.
- It may be proved that the witness made contradictory statements during the present trial.
- An attack may be made on the witness' general credibility (worthiness of belief).

In impeaching a witness for making contradictory statements, he must be asked specifically if he made the contradictory statement just read to him. He cannot be asked, merely, if he made a different statement. Also, the contradictory statements must have been made during the current trial.

As a rule, although the side that called the witness may introduce evidence of a contradictory nature, it may not impeach him or her. An exception to this rule is made when (1) the witness appears to be hostile to the side that called him or her, or (2) counsel who called the witness, because of the nature of the case, had to call the witness but was surprised by his or her testimony.

DEPOSITIONS AND AFFIDAVITS

The testimony of a witness, as a general rule, is given orally. Necessity may, however, require that testimony be given by deposition. It is well to remember that after the action begins (charges have been signed), any deposition permitted to be taken stands on the same footing as testimony at a trial. What, then, is a deposition? A *deposition* is a written declaration, under oath or affirmation, made by a witness in the presence of the

adverse party so that necessary cross-examination may be made.

A deposition must be taken in the presence of a competent official, usually a court officer or notary public. If a crime is committed or injury or damage occurs, parties concerned find it advisable to have the testimony of various witnesses reduced to writing as prospective evidence in later legal actions. From the standpoint of accuracy alone, depositions are helpful. A witness who testifies immediately after an event takes place is more likely to remember the facts than some months later. Because the witness is placed under oath and because there is an opportunity for cross-examination, depositions are not in violation of the hearsay rule.

An *affidavit* differs from a deposition in that it is a statement made without giving the other side an opportunity to ask questions of the declarer. Although an affidavit is a sworn statement, it ordinarily is inadmissible in evidence of the truth of matters therein stated, because it is a *hearsay* statement and is one-sided. Exceptions may be made in affidavits dealing with certain issues, such as character of the accused, loss of an original document, or matters in extenuation of a possible sentence, unless such exceptions appear to affect injuriously the substantial rights of the parties.

Testimony given in a former trial of the accused may be admitted if the accused had been tried on substantially the same charges. Also, such testimony is admissible if it can be proven that the witness cannot attend the present trial because he or she is dead, very ill, insane, or that he or she is prevented by the accused from attending. However, the mere fact that the witness is now beyond the jurisdiction of the court or that his or her whereabouts are unknown does not render such former testimony admissible.

EXAMINATION PROCEDURE

LEARNING OBJECTIVES: State the order in which witnesses are examined. Define leading-, double-, and forbidden questions. State the general rule regarding opinions and describe when notes can be used in court. Explain verification of testimony and weighing of evidence. Describe the cross-examination technique used in court.

The examination of a witness proceeds as follows: First, the direct examination by the party who called him; second, cross-examination by the opposite party; third, redirect examination; fourth, re-cross-examination. The court may allow additional

interrogation of a witness if further questioning is desirable.

All facts desired by the party who called the witness should be brought out in the direct examination. Objection may be raised by the other side if an attempt is made to bring out additional facts at a later time in the trial. On taking the stand, the witness must identify himself and (if possible) the accused.

LEADING QUESTIONS

Leading questions usually are not allowed on direct examination. *Leading questions* are questions that either suggest the answer desired of the witness or, embodying a material fact, are susceptible of being answered by a simple yes or no. A leading question, except on cross-examination, should be excluded upon proper objection. For example, if a knife is introduced in evidence, a witness should not be asked on direct examination whether it is the knife with which he saw the accused stab A. He should be asked first whether he recognizes the knife, and if he answers that he does, then he may be asked where he saw it and what was done with it.

To shorten the court proceedings, leading questions are sometimes allowed. For example, if the accused admits that he was arrested as a deserter on a certain day, at a certain place, by a policeman, the latter may be asked directly whether he arrested the accused on that day and at that place. Leading questions are allowed also when the witness appears hostile to the party who called him, or when the witness makes an erroneous answer, apparently caused by forgetfulness or a slip of the tongue, that a suggestion would set right. Under certain circumstances it is necessary to ask a leading question to enable the witness to better understand what is required. Such an instance may occur when he is called on to contradict a statement made in his absence by another witness.

DOUBLE QUESTIONS

Double questions are not permitted. An example of a double question is: "Did you see the accused with a bundle?" Actually, a *double question* is made up of two separate questions. The first is: "Did you see the accused?" The second is: "Did he have a bundle?"

FORBIDDEN QUESTIONS

A witness is not obligated to answer forbidden questions. Three classes of such questions are:

1. Questions involving state secrets. These include any question detrimental to the public interest, as well as classified military information.

2. Incriminating questions. This group includes questions that make the witness subject to criminal prosecution.

3. Degrading questions. These questions tend to degrade or disgrace the witness. A witness may refuse to answer a degrading question unless it deals with a material issue of the trial.

When a witness protests on the grounds of any of the foregoing forbidden questions, the court rules on whether the witness must answer the question or remain silent. If a witness was tried previously on the matter, and the conviction become final, the claim of privilege is disallowed because there is no further danger.

OPINIONS

It is a general rule that a witness must state facts and not opinions or conclusions. There are three main exceptions to this rule:

1. A witness may testify about opinions in matters based on daily observation and experience. For example, a witness may give an opinion of a person's sanity, sobriety, identity, or resemblance to another. Or a view regarding that person's physical or temperamental condition may be expressed when such an opinion is based on frequent contact with the person in question.

2. Another exception involves a question regarding who wrote or signed a document. Anyone acquainted with the handwriting of the supposed writer may give an opinion about whether it was written or signed by the writer.

3. The opinions of experts in a specialty are admissible in cases requiring a knowledge of such a specialty. Such witnesses must be proven to be actual experts in their line. Physicians, chemists, fingerprint experts, and ballistics specialists are often called as expert witnesses.

NOTES

Ordinarily, a witness whose memory fails on a particular point may be allowed to refer to notes. Thus, a Master-at-Arms normally is allowed to refer to his or her notebook regarding such items as the serial number of a gun, the exact dimensions of rooms, and the like. In such an instance, notes are not evidence; they merely serve to remind the MA of matters that can be testified to from memory.

Notes may be submitted directly as evidence when the witness cannot recall something but is able to testify that an accurate note was made. Both this paragraph and the preceding one point out the necessity for the MA to maintain accurate, complete, and legible notebooks.

VERIFICATION OF TESTIMONY

A witness maybe asked to verify testimony, which may be read to the witness or the witness may read the testimony from a copy of the court record. Then he or she is called before the court to correct, amend, or verify the testimony.

Witnesses are warned not to discuss their testimony with anyone. This warning is given to ensure that the testimony of a witness is not colored by what was heard from another witness. The defense and the prosecution, however, are allowed to discuss the case with their witnesses in advance. When collecting evidence for the prosecution, you may ascertain, through statements, what a witness knows of the case.

WEIGHING EVIDENCE

All evidence and testimony introduced at a trial are considered in reaching a verdict, together with facts of evidence recognized by the court. Such facts fall into three general groups, as follows:

1. The first group includes facts that are common knowledge to every person of ordinary intelligence. For instance, qualities and properties of matter; well-known scientific, geographical, historical, and physiological data; the composition and use of common articles; the character of weapons; time, days, and duties; and the existence, appearance, and value of money are included in this group.

2. Matters that maybe ascertained readily, such as the time of sunrise on a given day.

3. Matters that a court (civil or military) should know as part of its own special function, such as the Constitution, treaties, Federal law, the *UCMJ*, and General Orders.

As stated previously, members of the court may admit any of the aforementioned matters that apply, together with all the evidence introduced. Their knowledge of facts must come to them through the evidence; but, in weighing the evidence given by the various witnesses, members of the court are expected to use common sense, and knowledge of human nature and of the ways of the world. Thus, the court may believe one witness, yet disbelieve several witnesses whose testimony conflicts with that one.

CROSS-EXAMINATION

Cross-examination is intended to test the extent to which the testimony of a witness can be relied upon. An attempt to make a story stand up under cross-examination is difficult, especially when it is not

entirely true. Wide latitude is allowed in cross-examination, and leading questions are permitted. If the accused takes the stand, he or she usually is exposed to a searching cross-examination.

SUMMARY

As a Master-at-Arms, you are expected to have the greatest credibility. Your character should never be open to criticism. Develop your power of observation and memory to the fullest extent, and be straightforward in presenting your testimony. You must show no prejudice; your appearance must be smart; and your deportment must be above reproach. At all times, maintain the highest reputation for truthfulness. In this chapter, we have discussed the sources, applicability, and points of interest of the military law of evidence. The forms, types, and admissibility of evidence were also covered. Finally, court proceedings and examination techniques were discussed.

CHAPTER 5

COURTS-MARTIAL PROCEDURES

Courts-martial procedures differ according to the type of court. A summary court-martial has a simple procedure and is convened to try relatively minor offenses. A special court-martial is used to try serious offenses beyond the scope of a summary court-martial but not serious enough for trial by a general court-martial. The major differences in types of courts-martial are the maximum punishments adjudged and the manner in which you prepare the records of proceedings.

This chapter examines the types of courts-martial, the procedures used, and other matters that occur before and during a trial. In our discussion of trial methods, we will consider each court-martial separately. Now, let's take a look at the summary court-martial.

THE SUMMARY COURT-MARTIAL

LEARNING OBJECTIVES: Describe the creation of the summary court-martial and the preferral and referral of charges. Explain pretrial preparation and court procedures for the summary court-martial.

A summary court-martial is the least formal of the three types of courts-martial and the least protective of individual rights. The summary court-martial is a streamlined trial process involving only one officer, who performs the duties of prosecutor, defense counsel, judge, and jury. The purpose of the summary court-martial is to dispose of relatively minor offenses. One officer is assigned to perform the various roles. Since the summary court-martial affords the least protection for rights of the accused, the maximum punishment that this court can award is limited. Furthermore, only enlisted personnel who consent may be tried by summary court-martial.

The summary court-martial has no civilian equivalent. It is strictly a creature of statute within the military system. While it is a criminal proceeding, and technical rules of evidence apply and a finding of guilty can result in loss of liberty and property, there

is no constitutional right to representation by counsel. Therefore, it is not a true adversarial proceeding.

CREATION OF THE SUMMARY COURT-MARTIAL

An individual must be authorized by law to convene a summary court martial. Article 24, *Uniform Code of Military Justice* (UCMJ); *Rules for Courts-Martial* (R.C.M.) 1302a; *Manual for Courts-Martial* (MCM) 1984; and *Judge Advocate General Manual* (JAGMAN) 0120c identify those persons who have the power to convene a summary court-martial. These individuals include any person who may convene a special or general courts-martial; or the Commander or Officer-in-Charge of any command when empowered by the Secretary of the Navy.

The authority to convene a summary court martial rests in the office of the authorized command rather than in the person of its commander. For example, Captain Doe, U.S. Navy, has summary court-martial convening authority while performing his or her duties as Commanding Officer, USS *Mississippi*. When Captain Doe goes on leave or is absent from his command for other reasons he or she loses that authority. Convening power cannot be delegated, and no subordinate may exercise such authority "by direction." When Captain Doe is on leave from his or her ship, the authority to convene passes to the temporary successor in command (usually the executive officer), who, in the eyes of the law, becomes the acting commanding officer.

Commanding officers or officers-in charge not empowered to convene a summary court-martial may request such authority by following the procedures contained in JAGMAN 0121b.

Restrictions on Authority to Convene

Unlike the authority to impose non-judicial punishment, a superior commander may restrict the power to convene a summary court-martial. Further, a commander of a unit attached to a ship should, as a matter of policy, refrain from exercising his or her

summary-court-convening powers. He or she should refer such cases to the commanding officer of the ship for disposition while the unit is embarked. This policy does not apply to commanders of units that are embarked for transportation only. When an individual has already been tried by a state or foreign court, permission must be obtained from the officer exercising general court-martial jurisdiction before imposition of non-judicial punishment or referral to summary court-martial. Offenses that have already been tried in a court deriving its authority from the United States (U.S. District Courts) may not be tried by courts-martial.

If the convening authority or summary court-martial officer is the accuser, it is discretionary with the convening authority as to whether to forward the charges to a superior with a recommendation to convene the summary court-martial or convene the court himself. If the summary court officer is the accuser, the jurisdiction of the summary court is not affected.

Mechanics of Convening

Before any case can be brought before a summary court-martial, it must be properly convened. The summary court is created by order of the convening authority detailing the court-martial officer to the court. The convening order will specify that it is a summary court and appoint the summary court-martial officer. Additionally, the convening order may designate where the court-martial will meet. If the convening authority derives his or her power from designation by SECNAV, this information is included in the order. Each convening order is assigned a court-martial convening order number. The convening authority personally signs the convening order showing his or her name, grade and title, including organization and unit.

The *MCM*, 1984 authorizes the convening authority to convene a summary court-martial by a notation on the charge sheet when signed. However, the better practice is to use a separate convening order for the summary court-martial. Appendix 6b of the *MCM*, contains a suggested format. We will have another look at convening orders later in this manual.

Summary Court-Martial Officer

A summary court-martial requires only one officer. As a jurisdictional prerequisite, this officer must be a commissioned officer on active duty and of

the same armed force as the accused. (The Navy and Marine Corps are part of the same armed force.) Where practical, the officer's grade should not be below O-3. Age, education, experience, and judicial temperament are qualifications for the summary - court-martial officer, as his or her performance will have a direct impact upon the morale and discipline of the command. When more than one commissioned officer is present within the command or unit, the convening authority may not serve as summary court officer. When the convening authority is the only commissioned officer in the unit, he or she may serve as summary court-martial officer. This fact should be noted in the convening order and should be attached to the record of trial. When such a situation exists, the better practice is to appoint a summary court officer from outside the command. Note that the summary court-martial officer does not have to be from the same command as the accused.

Remember, the summary court-martial officer assumes the burden of prosecution, defense, judge, and jury. He or she must thoroughly and impartially inquire into both sides of the matter assuring that the interests of both the government and the accused are safeguarded and that justice is done. While the summary court-martial officer may seek advice from a judge advocate or legal officer on questions of law, the officer may not seek advice from anyone on questions of fact, since he or she has a duty to make these determinations independently.

Jurisdictional Limitations: Persons

Article 20, *UCMJ*, and R.C.M. 1301(c) provide a summary court-martial the power (jurisdiction) to try only those enlisted person who consent to be tried. The right of an enlisted accused to refuse trial by a summary court-martial is absolute. A summary court-martial may not try commissioned officers, warrant officers, cadets, aviation cadets, midshipmen, and those not subject to the *UCMJ*.

Jurisdictional Limitations: Offenses

A summary court has the power to try all offenses described in the *UCMJ* except those that require punishment beyond the maximum that can be imposed at a summary court-martial. For instance, a summary court cannot try capital offenses that involve the death penalty. Refer to R.C.M. 1004 for a discussion of capital offenses. A summary court-martial may dispose of any minor offense.

PREFERRAL AND REFERRAL OF CHARGES

In this section, we will focus on the mechanism for properly bringing a case to trial before a summary court-martial. Referral is the basic process by which you send a case to a particular type of court-martial. Preferral is when charges are formally made.

Preliminary Inquiry

Every court-martial case begins with a complaint by someone that a person subject to the *UCMJ* has committed an offense that results in the discovery of misconduct. The officer exercising immediate non-judicial punishment authority over the accused has the duty to make, or cause to be made, an inquiry into the truth of the complaint or apparent wrongdoing.

Preferral of Charges

Charges are formally made against an accused when signed and sworn to by a person subject to the *UCMJ*. This procedure is known as preferral of charges. You prefer charges by executing the appropriate portions of the charge sheet, DD Form 458. There are several steps involved in this preferral process. They are:

1. Personal data. Complete Block I of page 1 of the charge sheet first. You can find the information relating to personal data in the pertinent portions of the accused's service record.

2. The charges. Next, you complete Block II of page 1 of the charge sheet indicating the precise misconduct involved in the case. Each punitive article found in Part IV, *MCM*, 1984 contains sample specifications. If the charges are so numerous that they will not all fit in Block II, place them on a separate piece of paper as Attachment A.

3. Accuser. The accuser is a person subject to the *UCMJ* who signs Item 11 in Block III at the bottom of page 1 of the charge sheet. The accuser swears to the truth of the charges and has the affidavit executed before an officer authorized to administer oaths. This step is important, as an accused has a right to refuse trial on unsworn charges.

4. Oath. The oath must be administered to the accuser and the affidavit must show that it was executed by a person with proper authority. As authorized by Article 136, *UCMJ*, judge advocates, staff judge

advocates, legal officers, law specialists, summary court-martial officers, adjutants, Marine Corps and Navy commanding officers, among others, may administer oaths to the accuser. Also authorized to administer oaths are officers certified by the Judge Advocate General of the Navy as counsel under Article 27, *UCMJ*, all officers in paygrade O-4 and above, executive officers, and administrative officers of Marine Corps aircraft squadrons. Often the legal officer will administer the oath regardless of who conducted the preliminary inquiry. When the charges are signed and sworn to they are "preferred" against the accused.

Informing the Accused

Once formal charges have been signed and sworn to, the preferral process is complete. The preferred charges are then receipted for by the officer exercising summary court-martial jurisdiction over the accused. This officer or his or her designate should formally receipt for the preferred charges by completing the receipt section, Block IV, of the charge sheet. The purpose of this receipt certification is to stop the statute of limitations for the offense charged.

The next step is to inform the accused of the charges against him or her. The purpose of this step is to provide the accused with reasonable notice of an impending criminal prosecution. This action complies with standards of due process of law. The immediate commander is required to inform the accused of the following elements as soon as practicable:

1. the charges preferred against him or her;
2. the name of the person who preferred the charges; and,
3. the name of the person who ordered the charges to be preferred.

The person who gives notice to the accused executes Item 12 at the top of page 2 of the charge sheet. If not the immediate commander of the accused, the person signing on the signature line should state their rank, component, and authority. The law does not require a formal hearing to provide notice to the accused, but the charge sheet must show that notice was given.

When the accused is absent without leave at the time charges are sworn, it is permissible and proper to execute the receipt certification even though the accused cannot be advised of the existence of the charges. In such cases, attach a statement to the case file indicating the reason for the lack of notice. When

the accused returns to military control, notice should then be given.

Referral of Charges

Once the charge sheet and supporting materials are presented to the summary court-martial convening authority and a decision made to refer the case to a summary court, it must be sent to one of the summary court-martials previously convened. The referral is executed personally by the convening authority. It explicitly details the type of court (summary, special or general) and the specific court to which the case is being referred. This procedure is concluded by completing Item 14, Block V, on page 2 of the charge sheet.

In addition, the referral on page 2 of the charge sheet should show any particular instructions applicable to the case. These instructions could include statements such as, "confinement is not an authorized punishment in this case," or any other instructions desired by the convening authority. If no instructions apply to the particular case, the referral should so indicate by use of the word "none" in the appropriate blank. Once the referral is properly executed, the case is "referred" to trial. The case file should then be forwarded to the proper summary court-martial officer for further action.

PRETRIAL PREPARATION

After charges are referred to trial by a summary court, all case materials must be forwarded to the summary court-martial officer. He or she is then responsible for preparing the case for trial.

Preliminary Preparation

Upon receipt of the charges and accompanying papers, the summary court-martial officer begins preparation for trial. The charge sheet is carefully examined, and all obvious administrative, clerical, and typographical errors are corrected. The summary court-martial officer must initial each correction made on the charge sheet. If there are so many errors as to require preparation of a new charge sheet, re-swearing of the charges and re-referral are required. If the summary court officer changes an existing specification to include any new person, offense, or matter not fairly included in the original specification, again, the new specification must be re-sworn and re-referred. The summary court-martial officer continues with his or her examination of the charge

sheet to determine the correctness and completeness of the information on pages 1 and 2.

Pretrial Conference with the Accused

After initial review of the court-martial file, the summary court-martial officer meets with the accused in a pretrial conference. We will discuss the accused's right to counsel later in this chapter. If the accused elects representation by counsel, all dealings with the accused is through his or her counsel. Thus, the accused's counsel, if any, should be invited to attend the pretrial conference. At the pretrial conference, the summary court-martial officer follows the suggested guide found in appendix 9, MCM, 1984, and documents the fact that all applicable rights were explained to the accused.

PURPOSE.— The purpose of the pretrial conference is to provide the accused with information on the nature of the court-martial, the procedure to be used, and his or her rights with respect to that procedure. No attempt should be made by the summary court-martial officer to interrogate the accused or otherwise discuss the merits of the charges. The proper time to deal with the accusations against the accused is at trial. The summary court-martial officer should provide a meaningful and thorough briefing. It is most important that the accused fully understand the court-martial process and his or her rights pertaining to that process.

ADVICE TO ACCUSED—RIGHTS.— The summary court-martial officer should advise the accused of the following:

- The general nature of the charges.
- The fact that the charges have been referred to a summary court-martial for trial and the date of referral.
- The identity of the convening authority,
- The name of the accuser.
- The names of witnesses who may be called to testify and any documents or physical evidence that the summary court-martial officer expects to introduce.
- The accused's right to inspect the allied papers and personnel records immediately available.
- That during the trial the summary court officer will not consider any matters, including statements previously made by the accused, unless they are admitted in accordance with the military rules of evidence.

- The accused's right to plead not guilty or guilty.
- The accused's right to cross-examine witnesses and have the summary court-martial officer cross-examine witnesses on behalf of the accused.
- The accused's right to call witnesses and produce evidence with the assistance of the summary court-martial officer, if necessary.
- The accused's right to testify on the merits, or to remain silent with the assurance that no adverse inference will be drawn by the summary court-martial officer for such silence.
- If any findings of guilt are announced, the accused's right to remain silent, to make an unsworn statement, oral or written or both, to testify, and to introduce evidence in extenuation and mitigation.
- The accused's right to object to trial by summary court-martial.
- The maximum sentence that the summary court-martial officer may adjudge if the accused is found guilty of the offense(s) alleged.

Advice to accused should include the following maximum punishments that can be awarded at a summary court-martial.

SUMMARY COURT-MARTIAL PUNISHMENTS.— The maximum punishment at a summary court-martial is discussed in the following paragraphs.

E-4 and Below.— The jurisdictional maximum sentence that a summary court may adjudge in the case of an accused who, at the time of trial, is in paygrade E-4 or below extends to (1) reduction to the lowest paygrade; (2) forfeiture of 2/3 of 1-month's pay, not to be apportioned over more than 3 months; (3) a fine not to exceed 2/3 of 1 month's pay; (4) confinement not to exceed 1 month; (5) hard labor without confinement not to exceed 45 days (in lieu of confinement); and (6) restriction to specified limits for 2 months. If the accused is attached to or embarked in a vessel and is in paygrade E-3 or below, he or she may be sentenced to serve 3 days' confinement on bread and water/diminished rations and 24 days' confinement in lieu of 30 days' confinement.

E-5 and Above.— The jurisdictional maximum that a summary court can impose in the case of an accused who, at the time of trial, is in paygrade E-5 or above extends to (1) reduction, but only to the next inferior paygrade; (2) restriction to specified limits

for 2 months; and (3) forfeiture of 2/3 of 1 month's pay. Unlike non-judicial punishment, where an E-4 may be reduced to E-3 and then awarded restraint punishments imposed only upon an E-3 or below, at a summary court-martial an E-5 cannot be sentenced to confinement or hard labor without confinement, even if a reduction to E-4 has also been adjudged.

ADVICE TO ACCUSED—COUNSEL.—

While the *MCM*, 1984, creates no statutory right to provide a military defense counsel at a summary court-martial, it has created a limited right to civilian defense counsel. Therefore, the convening authority may still permit the presence of a counsel if the accused can obtain such counsel. The accused has a right to hire a civilian lawyer and have that lawyer appear at trial, if such appearance will not necessarily delay the proceedings and if military exigencies do not prevent it. The accused must, however, bear the expenses involved. If requested, the summary court officer should allow a reasonable time for the accused to retain a civilian counsel.

Even though an accused has no right to military counsel at a summary court-martial, if not given an opportunity to consult with counsel before accepting a summary court-martial, the summary court findings will be inadmissible at a later trial by court-martial. The term *independent counsel* means a lawyer qualified in the sense of Article 27(b), *UCMJ*, who in the course of regular duties does not act as the principle legal advisor to the convening authority.

To be admissible at a later trial by court-martial, evidence of a summary court-martial at which an accused was not represented by counsel must affirmatively demonstrate that

- the accused was advised of his or her right to confer with counsel prior to deciding to accept trial by summary-court martial;
- the accused either exercised his or her right to confer with counsel or made a voluntary, knowing, and intelligent waiver; and
- the accused voluntarily, knowingly, and intelligently waived his or her right to refuse a summary court-martial.

When an accused has been properly advised of the right to consult with counsel and to refuse a summary court-martial, the elections or waiver in this regard are made in writing and signed by the accused. Use a form

similar to that shown in figure 5-1 to record the advice/waiver. The "Acknowledgement of Rights and Waiver," properly completed, contains all the necessary advice to an accused. When it is properly executed it will establish a voluntary, knowing, and intelligent waiver of the accused's right to consult with counsel and/or his or her right to refuse trial by summary court-martial. A page 13 entry in the accused's service record should be made, and a copy of the form should be attached to the record of trial.

Assuming these Booker warnings have been given (proper advice and recording of election/waivers), evidence of the summary court-martial will be admissible at a later trial by court-martial.

Final Pretrial Preparation

After the pretrial interview, the summary court officer determines whether the accused has decided to accept or refuse trial by summary court-martial. If the accused needs more time to decide, it should be

**SUMMARY COURT-MARTIAL
ACKNOWLEDGEMENT OF RIGHTS AND WAIVER**

I, _____,
assigned to _____,
acknowledge the following facts and rights regarding summary courts-martial:

1. I have the right to consult with a lawyer prior to deciding whether to accept or refuse trial by summary court-martial. Should I desire to consult with counsel, I understand that a military lawyer may be made available to advise me, free of charge, or, I may consult with a civilian lawyer at my own expense.
2. I realize that I may refuse trial by summary court-martial, in which event the commanding officer may refer the charge(s) to a special court-martial. My rights at a summary court-martial include
 - a. the right to confront and cross-examine all witnesses against me;
 - b. the right to plead not guilty and the right to remain silent, thus placing upon the government the burden of proving my guilt beyond a reasonable doubt;
 - c. the right to have the summary court-martial call, or subpoena, witnesses to testify in my behalf;
 - d. the right, if found guilty, to present matters that may mitigate the offense or demonstrate extenuating circumstances as to why I committed the offense(s); and
 - e. the right to be represented at trial by a civilian lawyer provided by me at my own expense, if such appearance will not unreasonably delay the proceedings and if military exigencies do not preclude it.
3. I understand that the maximum punishment that may be imposed at a summary court-martial is

<u>E-4 and below</u> Confinement for 1 month 45 days' hard labor without confinement 60 days' restriction Forfeiture of 2/3 pay for 1 month Reduction to the lowest paygrade	<u>E-5 and above</u> 60 days' restriction Forfeiture of 2/3 pay for 1 month Reduction to next inferior paygrade
--	--

Figure 5-1.—Summary Court-Martial Acknowledgement of Rights and Waiver.

4. Should I refuse trial by summary court-martial, the commanding officer may refer the charge(s) to trial by special court-martial. At a special court-martial, in addition to those rights set forth above with respect to a summary court-martial, I would also have the following rights:

a. The right to be represented at trial by a military lawyer, free of charge, including a military lawyer of my own selection if he or she is reasonably available. I would also have the right to be represented by a civilian lawyer at my own expense.

b. The right to be tried by a special court-martial composed of at least three officers as members or, at my request, at least one-third of the court members would be enlisted personnel. If tried by a court-martial with members, two-thirds of the members, voting by secret written ballot, would have to agree in any finding of guilty, and two-thirds of the members would also have to agree on any sentence to be imposed should I be found guilty.

c. The right to request trial by military judge alone. If tried by a military judge alone, the military judge alone would determine my guilt or innocence and, if found guilty, he or she alone would determine the sentence.

5. I understand that the punishments that can be imposed at a special court-martial for the offense(s) presently charged against me are:

Discharge from the naval service with a bad conduct discharge (delete if inappropriate);

Confinement for _____ months;

Forfeiture of 2/3 pay per month for _____ months;

Reduction to the lowest enlisted pay grade (E-1).

Knowing and understanding my rights as set forth above, I (do) (do not) desire to consult with counsel before deciding whether to accept trial by summary court-martial.

Knowing and understanding my rights as set forth above (and having first consulted with counsel), I hereby (consent) (object) to trial by summary court-martial.

Signature of accused and date

Signature of witness and date

Figure 5-1.—Summary Court-Martial Acknowledgement of Rights and Waiver—Continued.

provided. If the case is to proceed, the witnesses or the description of other evidence that the accused wishes to present at trial should be identified. The summary court-martial officer arranges for a time and place to hold the open session of the trial. These arrangements are made through the legal officer, and the summary court officer notifies all personnel involved of the time and place of the first meeting.

The summary court-martial officer plans an orderly trial procedure to include a chronological presentation of the facts. Appendix IX, *MCM*, is a summary court-martial trial guide. The summary court-martial officer should follow it closely and precisely during the hearing. The admissibility and authenticity of all known evidentiary matters are determined and numbers assigned to all exhibits to be

offered at trial. The evidence reviewed by the summary court officer includes not only that contained in the original file but also any other relevant evidence discovered by other means. The summary court-martial officer has the duty to insure that all relevant and competent evidence in the case, both for and against the accused, is presented. It is the responsibility of the summary court officer to ensure that only legal and competent evidence is received and considered at the trial. The military rules of evidence apply to a summary court-martial and must be followed. Therefore, only legal and competent evidence received in the presence of the accused at trial can be considered in determining guilt or innocence. If a question regarding admissibility of evidence arises, the summary court officer may seek assistance from a Navy Legal Service Office in resolving the issue.

The summary court is authorized to issue subpoenas to compel the appearance at trial of civilian witnesses. In such a case, the summary court-martial officer follows the same procedure that a special or general court-martial trial counsel would follow.

SUMMARY COURT-MARTIAL: TRIAL PROCEEDINGS

The actual trial procedure, while different from a special or general court-martial, is governed by the same principles and procedures. The major steps of the summary court-martial include the arraignment, motions, pleas, presentation of the evidence, and findings and sentence. Let's look at each of these steps individually.

Arraignment

The summary court-martial officer reads and shows the charges and specifications to the accused and, if necessary, explains them. The accused may waive the reading of the charges. The summary court-martial officer then asks the accused to plead to each charge and specification.

Motions

Before receiving pleas, the summary court-martial officer allows the accused to make motions to dismiss or for any other relief. When requested by the accused, the summary court-martial officer, in the interest of justice, takes appropriate action on behalf of the accused.

Pleas

When a not-guilty plea is entered, the summary court-martial officer proceeds to trial. If the accused pleads guilty to any offense, the summary court officer determines the providence of the plea. If the summary court officer doubts that the accused's plea of guilty was not voluntarily and understandingly made, or if at any time during the trial any matter inconsistent with the plea of guilty arises, the summary court-martial officer enters a not-guilty plea on behalf of the accused. If the accused refuses to plead, the summary court-martial officer enters a not-guilty plea. The accused may change any plea at any time before findings are announced.

Presentation of Evidence

Witnesses for the prosecution are called first and examined under oath. The accused is permitted to cross-examine these witnesses. The summary court-martial officer can aid the accused in the cross-examination process. The witnesses for the accused are then called and examined under oath. The summary court-martial officer then evaluates the evidence to prove or disprove the accused's guilt or innocence or to establish extenuating circumstances.

Findings and Sentence

The summary court-martial officer announces the findings and sentence to the accused in open session. If the sentence includes confinement, the summary court officer advises the accused of the right to apply to the convening authority for deferment of the sentence to confinement. If the accused is found guilty, he or she is informed of the right to submit matters to the convening authority within 7 days.

SPECIAL COURT-MARTIAL

LEARNING OBJECTIVES: Describe the creation and composition of the special court-martial. Determine the qualification of members and the military judge. Describe the referral of charges and how charges can be modified. Explain the special court-martial procedures.

The special court-martial is the intermediate level court-martial created by the *Uniform Code of Military Justice*. The maximum penalties that an accused may receive at a special court-martial are generally greater

than those of a summary court-, but less than those of a general court-martial. The rights of an accused are also generally greater as the maximum penalties increase with each type of court-martial. The special court-martial is a court consisting of at least three members, a trial counsel, a defense counsel, and a military judge. The maximum punishment at a special court extends to a bad-conduct discharge, 6 months' confinement, forfeiture of two-thirds pay per month for 6 months, and reduction to paygrade E-1. This chapter will discuss the special court-martial in detail.

CREATION OF THE SPECIAL COURT-MARTIAL

Article 23, *UCMJ* and *JAGMAN* 0120b prescribe who has the power to convene (create) a special court-martial. As with the summary court-martial, the power to convene a special court-martial is nondelegable, and in no event can a subordinate exercise such authority.

The commander of a unit embarked on a naval vessel who is authorized to convene a special court-martial should refrain from exercising such authority and defer instead to the wishes of the ship's commander.

Before any case can be brought before a special court-martial, it must be convened. The creation of a special court-martial is accomplished by the written orders of the convening authority.

Basically, the order is under command letterhead, is dated and serialized, and is signed personally by the convening authority. The order specifies the names and ranks of all members detailed to serve on the court. Signature titles such as "Acting Commanding Officer" and "Executive Officer" should not be used on legal documents, regardless of the validity of such titles on other administrative correspondence. When a proper convening order is executed, a special court-martial is created and remains in existence until dissolved.

COMPOSITION OF THE SPECIAL COURT-MARTIAL

There are several configurations of a special court-martial, depending upon either the desires of the convening authority or the desires of the accused. The constitution of the court refers to the court's composition, that is, the personnel involved. The

composition of the types of special court-martial is discussed in the following paragraphs.

Three Members

One type of special court-martial consists of a minimum of three members and counsel, but no military judge. Such a special court-martial can try any case referred to it but cannot adjudge a sentence (in enlisted cases) of more than 6 months' confinement, forfeiture of 2/3 pay per month for 6 months, and reduction to paygrade E-1. So, in ordinary circumstances, a punitive discharge from service may not be adjudged. When a three-member type court-martial is used, the convening authority must include in the referral block on the charge sheet that a bad conduct discharge (BBCD) is not an authorized punishment.

Military Judge and Members

Another type of special court-martial involves counsel, at least three members, and a military judge. The role of the members is similar to that of a civilian jury. They determine guilt or innocence and impose sentence. The senior member is, in effect, the jury foreman, who presides during deliberations. The military judge functions like a civilian criminal court judge. He or she resolves all legal questions that arise and directs the trial proceedings. This form of special court-martial is authorized to adjudge a punitive discharge and has become fairly standard in the naval service.

Military Judge Alone

The special court-martial consisting of a military judge alone is not created by a convening order, but by exercise of a statutory right of the accused. The accused has the right to request orally on the record or in writing, a trial by military judge alone (without members). Before choosing to be tried by judge alone, an accused is entitled to know who the judge will be. The trial counsel (prosecutor) may argue against a request for a judge-alone trial when presented. The judge rules on the request and, if the request is granted, the court members are dismissed for that case only. A court-martial so configured is authorized to impose a sentence extending to a punitive discharge.

CONSTITUTION OF THE COURT

In order for a court-martial to properly try a case, it must have strict constitution. That is, it must have jurisdiction over the offense, the defendant, and a proper convening authority. A deficiency in any of these requisites makes the court powerless to adjudicate a case lawfully. The rules relating to constitution of the court must therefore be carefully observed.

QUALIFICATIONS OF MEMBERS

The convening authority has the ultimate legal responsibility to select the court members; that authority cannot be delegated. The convening authority appoints as members only those personnel who, in his or her judgment, are best qualified by reason of age, education, training, experience, length of service, and judicial temperament. These factors, of course, vary with individuals and do not necessarily depend on the grade of the particular person. No person in arrestor confinement is eligible to be a court member. Similarly, no person who is an accuser, witness for the prosecution, or has acted as investigative officer or counsel in a given case is eligible to serve as a member for that case. Although the convening authority may choose from lists suggested by subordinates, the final decision on members of a court rests with the office of the convening authority.

Commissioned Officers

The members of a special court-martial must, as a general rule, be commissioned officers. When the accused is an enlisted service member, non-commissioned warrant officers are eligible to be court members. No member of the court should be junior in grade to the accused if it can be avoided. Members of an armed force other than that of the accused may be used, but at least a majority of the members should be of the same armed force as the accused.

Enlisted Members

An enlisted accused has a right to be tried by a court consisting of at least one-third enlisted members. The accused must ask for enlisted membership by a personally signed request either before the conclusion of a pretrial hearing (Article 39a, UCMJ), or before the assembly of the court at

trial, or make the request orally on the record. Enlisted persons assigned to the same unit as the accused may not serve on the court. Only those enlisted members assigned to other units may lawfully serve on the court. "Unit" means company, squadron, battery, ship, or similar sized element.

If enlisted members cannot be found to serve, the convening authority may direct the court to proceed with trial. Such actions should only be taken when enlisted service members cannot be assigned because of extraordinary circumstances. In such a case, the convening authority forwards to counsel a detailed explanation of the circumstances, and why the trial must proceed without enlisted members.

QUALIFICATIONS OF THE MILITARY JUDGE

The military judge of a special court-martial must be a commissioned officer, a member of the bar of a Federal court, or the highest court of any state, and certified by the Judge Advocate General as qualified to be a military judge. A military judge qualified to act on general court-martial cases can also act in special court-martial cases.

REFERRAL OF CHARGES

The process of referring a case to trial by special court-martial is essentially the same as that for referral to a summary court-martial. Thus, the principles that apply to the preliminary inquiry, referral of charges, informing the accused, and receipt of sworn charges also apply to the special court-martial. As far as the referral process is concerned, the only essential difference between the referral of a summary and a special court-martial is the information contained in Block 14 on page 2 of the charge sheet.

Referral to Trial

If, after reviewing the applicable evidence, and the convening authority determines that trial by special court-martial is warranted, he or she executes Section V of the charge sheet. In addition to the command data entered on the appropriate lines of Block 14, the convening authority indicates the type of court-martial, the court-martial assignment, and any special instructions. Block 14 is then personally signed by the convening authority or by personal order reflecting the signer's authority. It might serve well to recall that a clear and concise serial system is essential to proper referral. The referral should identify a particular court

to hear the case; that is, it should relate to a specific convening order. Care should be taken in preparing convening orders and referral blocks to avoid confusion and legal complications at trial.

Withdrawal of Charges

Withdrawal of charges is a process in which the convening authority removes a court-martial case previously referred to it for trial. The convening authority cannot withdraw charges from one court and refer them to another without reason. These reasons are articulated in writing by the convening authority and included in the record of trial when the case is tried by the second court. The convening authority may withdraw charges for the purpose of dismissing them for any reason deemed sufficient. The withdrawal is accomplished by drawing a diagonal line across the referral block on page 2 of the charge sheet and having the convening authority initial the line-out. It is also advisable to write "withdrawn" across the endorsement and to date the action.

DISESTABLISHMENT OF THE COURT.—

Perhaps the most frequent withdrawal problem is presented when the convening authority wants to disestablish the court and create another to take its place. This usually happens when several members have been transferred or when the particular court has been in existence for a long time and the convening authority wants to relieve the court. Such grounds are valid and constitute a "proper reason." However, if evidence shows that a change was made because a convening authority was displeased with the leniency of a sentence or the number of acquittals, then the withdrawal would not be lawful. Whenever a new court relieves an old one, it creates a problem with respect to those cases previously referred to the old court and those now being referred to the new court. Remember, only the court to which a case is specifically referred can try it. The convening authority should withdraw each case from the old court (by lining out the referral block) and then referring the case to the new court. This action is accomplished by executing a new Block 14 referral on the charge sheet, indicating the serial number and date of the convening order that appoints the new court. The new referral should be taped (at the top) over the old lined-out referral to allow inspection of both referrals.

CHANGE IN COURT: NO DISESTABLISHMENT.— Sometimes a convening authority may have good cause for withdrawing a case from a court but

has no intention of disestablishing that court. For instance, one of several court panels may be backlogged, and the convening authority may wish to redistribute the pending cases. This action is accomplished by lining out and initialing the old referral block on the charge sheet and executing anew Block 14, referring the case to a new court. Again, the new Block 14 is taped over the old one to allow inspection of both referrals.

Amendment of Charges

In some instances, an amendment to charges will necessitate further administrative action with respect to the charge sheet. Minor changes in the form of correction of typographical errors normally will require no more administrative action than lining out and initialing the erroneous data and substituting the correct data. If, on the other hand, the contemplated change involves any new person, offense, or matter not fairly included in the charges as originally preferred, the amended specification must go through the preferral-referral process or the accused can exercise his or her right to object to trial on the unsworn charges.

Additional Charges

If, while awaiting trial on certain charges, an accused commits new offenses or if other previously-unknown offenses are discovered, an entirely new charge sheet must be prepared. Using the Special Instructions section of the Referral block, the convening authority states that the additional charges are to be tried together with the charges originally referred to the court-martial.

SPECIAL COURT-MARTIAL: TRIAL PROCEEDINGS

It is not necessary that you have a complete understanding of the many and complex rules and procedures of the special court-martial. It is essential, however, that you have a general knowledge of the mechanics of the trial process. Although an infinite number of variations may exist in any particular case, the general arrangement includes service of charges, pretrial hearings, preliminary matters, arraignment, motions, and pleas.

Service of Charges

In times of peace, no person can be brought to trial in any special court-martial until 3 days after formal charges have been served. In computing the 3-day period, you may not count the date of service or the date of trial. Sundays and holidays do count, however, in computing the statutory period. If the accused is served on Wednesday, he or she could not be tried before Sunday, and, as a practical matter, not before Monday. An accused can lawfully object to participating in trial proceedings before the 3-day waiting period has expired. The accused may, however, waive the 3-day period, so long as he or she understands the right and voluntarily agrees to go to trial earlier. At U.S. shore establishments, trials normally do not occur on the weekends. However, when ships are at sea or in overseas ports, trial is possible at any time, any day of the week.

The date charges are served upon the accused is reflected by the certificate in Block 15 of page 2 of the charge sheet. The trial counsel normally executes this certificate when he or she personally presents a copy to the accused. The trial counsel must personally serve the accused, even though the accused may have been previously informed of the charges. The service of the charge sheet may also be accomplished by the command at any time after referral as long as the accused is served personally.

Pretrial Hearings

After the 3-day period has elapsed, the military judge may hold sessions of court without members to litigate motions, objections, and other matters not amounting to a trial of the accused's guilt or innocence. The accused may be arraigned and his pleas taken and determined at such a hearing. At such hearings, the judge, trial counsel, defense counsel, accused, and a reporter will be present. Several such hearings may be held if desired. These hearings are commonly referred to as Article 39(a) sessions.

Preliminary Matters

At the initial pretrial hearing, the first order of business is to incorporate into the record those documents relating to the convening of the court and referral of the case for trial. Also, all oaths are administered. The convening order, the charge sheet, and any amendments to either document become matters of record at this point in the proceedings.

In addition, an accounting is made of all personnel required to be present. This accounting includes all persons named in the convening order, the counsel, the reporter, and the military judge. Also, all personnel qualifications are checked for the record.

The Arraignment

The arraignment is the reading of charges to the accused and asking for the accused's plea. The arraignment is complete when the accused is asked to enter his or her plea. This stage is an important one in the trial. After arraignment, if the accused voluntarily absents himself or herself without authority or does not appear during court sessions, he or she may nevertheless be tried and, if the evidence warrants, convicted. The arraignment is also the cut-off point for adding charges to the trial. After arraignment, no new charges can be added without the consent of the accused.

Motions

At arraignment, the military judge advises the accused that pleas are about to be requested and that if any motions are to be made, they should be presented. Many times motions such as attacking jurisdiction, sufficiency of charges, illegal pretrial confinement, and speedy trial will have already been litigated at a pretrial hearing. Nevertheless, the accused may decide to make additional motions and is allowed to do so. If there are motions, they are litigated at this time. If there are no motions, the trial proceeds.

Pleas

The responses of the accused to each specification and charge are known as the pleas. The recognized pleas in military practice are guilty, not guilty, guilty of a lesser included offense, and under some circumstances, a conditional plea of guilty. Any other pleas (such as *nolo contendere*) are improper, and the military judge enters a plea of not guilty.

NOT-GUILTY PLEAS.— When not-guilty pleas are entered by the accused or by the court, the trial proceeds to the presentation of evidence. The prosecutor begins, followed by the defense.

GUILTY PLEAS.— When guilty pleas are entered or when the accused pleads guilty of a lesser included offense, the judge determines that such pleas are made knowingly and voluntarily and that the

accused understands the meaning and effect of such pleas. This process is known as providence. The military judge advises the accused (1) of the maximum sentence that can be imposed in his or her case; (2) that a plea of guilty is the strongest form of proof known to the law; and (3) that by pleading guilty the accused is giving up the right to a trial of the facts, the right against self-incrimination, and the right to confront and to cross-examine the witnesses. In addition, the judge explores the facts thoroughly with the accused to obtain an admission of guilt-in-fact to each element of the offense (or offenses) to which the pleas relate.

CONDITIONAL PLEAS.— With the approval of the military judge and the consent of the trial counsel, an accused may enter a conditional plea of guilty. The main purpose of a conditional plea is to preserve for appellate review certain adverse determinations which the military judge may make against the accused regarding pretrial motions. If the accused prevails on appeal, his or her conditional plea of guilty may then be withdrawn.

Assembly of the Court

After the accused enters pleas, the military judge assembles the court. The members enter the courtroom and the military judge announces that all parties are present, and the members are sworn. The court is then assembled. After assembly, the military judge may give preliminary instructions to the members. Any witnesses who are expected to be called are asked to leave the courtroom. The trial counsel restates the general nature of the charges in the case for the benefit of the members.

Challenge Procedure

When the court is composed of members, the next stage will involve a determination of the eligibility of court members to participate in the trial. Members may be asked questions individually or collectively. This procedure is called *voir dire*. This procedure determines whether or not a member is suitable to sit as a member of the court-martial.

Both trial and defense counsel is given an opportunity to question each member to see if grounds for a challenge exists. In this connection, there are two types of challenges: (1) challenges for cause, and (2) peremptory challenges. A challenge, if sustained by the judge, excuses the member from the trial. The law places no limit on the number of challenges for cause that can be made at trial, but the trial counsel and

counsel for the defense are each limited to only one peremptory challenge. A *peremptory challenge* is challenge that can be made for any reason.

Case on the Merits

At this point the military judge announces the plea of the accused. The trial counsel and defense counsel make an opening statement to the court before the presentation of evidence begins. After opening statements are made, the prosecution commences presenting his or her case-in-chief. Each party has full opportunity to present evidence. Ordinarily the following sequence is used:

- Presentation of evidence for the prosecution
- Presentation of evidence for the defense
- Presentation of prosecution evidence in rebuttal
- Presentation of defense evidence in surrebuttal
- Additional rebuttal evidence at the discretion of the military judge
- Presentation of evidence requested by the military judge or members

A trial does not have to follow that order of events. For example, the defense may elect to make its opening statement and present evidence for the defense after the prosecution has rested.

The testimony of witnesses is taken orally in open session. Each witness must testify under oath. After the witness is sworn, he or she is identified for the record. The party calling the witness conducts direct examination of the witness, followed by cross-examination of the witness by the opposing party. Redirect and recross-examinations are conducted as necessary followed by any questioning by the military judge or members. All documentary and real evidence is marked and introduced into evidence.

Arguments on Findings

After all evidence has been presented, the trial counsel makes arguments on findings. The trial counsel presents argument, followed by the defense counsel. In this stage the trial counsel is allowed to make another argument, rebutting anything that was brought up by the defense counsel. After all arguments are complete, the military judge instructs the members

on findings. The members then withdraw from the courtroom for deliberation.

If the court is composed of members, the president of the court will announce the findings. When there are no members, the judge announces findings. At a special court-martial, two-thirds of the members present at trial must agree on each finding of guilty. In computing the necessary number of votes to convict, a fraction is counted as one. Thus, on a court of five members, the number of voters required to convict is three and one-third, or, applying the rule, four votes. In a trial by military judge alone, the required number of votes is one: the judge's.

Pre-sentencing Procedure

After findings of guilty have been announced, the prosecution and defense may present matters to aid the court-martial in determining an appropriate sentence. Such matters are ordinarily presented in the following sequence:

1. Service record data relating to the accused taken from the charge sheet
2. Personal data relating to prior service of the accused taken from the service record
3. Evidence of prior convictions, military or civilian
4. Evidence of rehabilitative potential

Extenuation and Mitigation

The defense may present matters in rebuttal of any material presented by the prosecution and may present matters in extenuation and mitigation. Matters in extenuation of an offense explains the circumstances of an offense, including those reasons for committing the offense which do not constitute a legal justification or excuse. Matters in mitigation of an offense is introduced to lessen the punishment adjudged by the court-martial, or to furnish grounds for clemency.

The accused may testify, make an unsworn statement, both in extenuation or mitigation, or rebut matters presented by the prosecution. The accused must limit such testimony or statements to those specifications to which the accused has been found guilty.

Arguments on Sentence

After introduction of matters relating to the sentencing, counsel for the prosecution and defense may argue for an appropriate sentence. Again, in a members trial, the military judge will instruct the members on sentencing. As with findings, two-thirds of the members must agree on a particular sentence. In a members trial, the president of the court will announce sentence; otherwise the military judge announces it. Immediately after sentencing, the military judge informs the accused of post-trial and appellate rights.

Adjournment

The military judge adjourns the court-martial at the end of a trial of an accused or proceeds to try other cases referred to that court-martial.

Clemency

After trial, any or all court members and the military judge may recommend that the convening authority exercise clemency to reduce the sentence, notwithstanding their vote on the sentence at trial.

THE GENERAL COURT-MARTIAL

LEARNING OBJECTIVES: Describe the pretrial investigation and identify the parties involved and explain the duties of each. Explain general court-martial proceedings.

The general court-martial is the highest court in the military justice system. A general court may impose the greatest penalties provided by military law. The general court-martial is composed of a minimum of five members, a military judge, and lawyers for the government and the accused. In some cases, the court is composed of a military judge and counsel. The general court-martial is created by the order of a flag or general officer in much the same manner as the special court-martial is created by subordinate commanders. Before trial by general court-martial may lawfully occur, a formal investigation of the alleged offenses must be conducted and a report forwarded to the general court-martial convening authority. The pretrial investigation, often referred to as an Article 32 investigation, is normally convened by a summary court-martial convening authority. The next section

will discuss the legal requisites of the pretrial investigation,

THE PRETRIAL INVESTIGATION

The formal pretrial investigation (Article 32, *UCMJ*) is the military equivalent of the grand jury proceeding in a civilian court. The pretrial investigation will formally inquire into the allegations contained in the charge sheet; it will secure information on how to dispose of the case, and aid the accused in defending against the evidence. Basically, this investigation is protection for the accused, but it is also useful for the prosecutor. The pretrial investigation will enable the prosecutor to test the case for its strength and determine whether to continue with the case or seek dismissal if too frail or groundless.

Authority to Direct

The pretrial investigation may be directed by one authorized by law to convene a summary or higher level court-martial. As is true of all other forms of convening authority, the power to order the Article 32, *UCMJ* pretrial investigation resides in the office of the commander.

Mechanics of Convening

When a summary court or higher convening authority receives charges against an accused that are serious enough to warrant trial by a general court, the convening authority directs a pretrial investigation. Written orders of the convening authority assign personnel to participate in the investigation. At the time the investigation is ordered, the charge sheet will have been completed up to, but not including, the Referral block on page 2. Unlike courts-martial, pretrial investigations are directed as required, and standing orders for such proceedings are inappropriate. And there is no separate referral of a case to a pretrial investigation, since the order creating the investigation amounts to a referral of the case. The original appointing order is forwarded to the investigating officer along with the charge sheet, allied papers, and a blank investigating officer's report form (DD Form 457).

Investigating Officer

The pretrial investigation is a formal one-officer investigation into alleged criminal misconduct. The investigating officer must be a commissioned officer

who should be a major or lieutenant commander or above, or an officer with legal training. The advantages of appointing a judge advocate (when available) to act as the investigating officer are substantial, especially in view of the increasingly complex nature of the military judicial process. An accuser, prospective military judge, or prospective trial or defense counsel for the same case may not act as investigating officer. Further, the investigating officer must be impartial and cannot previously have had a role in inquiring into the offenses involved, such as the provost marshal or public affairs officer. But, prior knowledge of the facts alone will not disqualify a prospective investigating officer. If the investigating officer is biased by such knowledge, however, then he or she is not the impartial investigator required by law. The law requires an investigating officer who is mature, fair, and impartial. That such an officer be appointed is the responsibility of the convening authority. If an investigating officer who is not a lawyer seeks advice regarding the investigation, that advice should not be requested from one who is likely to prosecute the case.

Counsel for the Government

While the pretrial investigation need not be an adversarial proceeding, current practice favors having the convening authority detail a lawyer to represent the interests of the government, especially when the investigating officer is not a lawyer. The assignment of a counsel for the government does not lessen the obligation of the investigating officer to investigate the alleged offenses thoroughly and impartially. As a practical matter, however, the presence of the lawyers representing the government and the accused do make the pretrial investigation an adversarial proceeding. During the investigation, the counsel for the government will present evidence to support allegations contained on the charge sheet, much like a prosecutor at trial.

Defense Counsel

An accused has extensive rights to counsel at the pretrial investigation, as well as at the general court-martial. More specifically, an accused may be represented by civilian counsel and by a detailed military lawyer. The civilian counsel must be provided by the accused at no expense to the government. The detailed military lawyer must be certified in accordance with Article 27(b), *UCMJ*, and can be a military lawyer of his or her own choice at no cost if

such counsel is reasonably available. Detailed defense counsel at a pretrial investigation must be a certified lawyer and be designated by the appointing order. Individual counsel, military or civilian, is normally not detailed on the appointing order. An accused is not entitled to more than one military counsel in the same case,

Reporter

There is no requirement that a record of the pretrial investigation proceedings be made other than the completion of the investigating officer's report. Accordingly, a reporter need not be detailed. It is common practice, however, to assign a reporter to

prepare a verbatim record, particularly in complex cases. When such a record is desired, the convening authority may detail a reporter, but this assignment is usually made orally and is not part of the appointing order.

Appointing Order

The order directing a pretrial investigation may be drafted in any acceptable form so long as an investigation is ordered and an investigating officer and counsel are detailed. A suggested format is shown in figure 5-2.

<p>DEPARTMENT OF THE NAVY U.S. Naval Support Activity FPO New York, NY 09521-1000</p> <p style="text-align: right;">17 Jul 19CY</p> <p>In accordance with Rules for Courts Martial (R.C.M.) 405, Manual for Courts Martial (MCM), 1984, Commander Jon T. Boate, JAGC, U.S. Navy, is hereby appointed to investigate the attached charges preferred against Seaman Very C. Pistol, U.S. Navy. The charge sheet and allied papers are appended hereto. The investigating officer will be guided by the provisions of R.C.M. 405, MCM, 1984, and current case law relating to the conduct of pretrial investigations. In addition to the investigating officer hereby appointed, the following personnel are detailed to the investigation for the purposes indicated:</p> <p style="text-align: center;">COUNSEL FOR THE GOVERNMENT</p> <p>Lieutenant Jane B. Doe, JAGC, U.S. Naval Reserve, certified in accordance with Article 27(b), Uniform Code of Military Justice.</p> <p style="text-align: center;">DEFENSE COUNSEL</p> <p>Lieutenant Mary (N) Christmas, JAGC, U.S. Naval Reserve, certified in accordance with Article 27(b), Uniform Code of Military Justice.</p> <p style="text-align: right;">WATER T. DOOR Captain, U.S. Navy Commanding Officer U.S. Naval Support Activity Naples, Italy</p>

Figure 5-2.—Sample Appointing Order for Article 32 Pretrial Investigation.

PREPARATION FOR PRETRIAL HEARING

When the pretrial investigation officer receives his or her orders of appointment, the charge sheet and allied papers should first be studied to become thoroughly familiar with the case. The charge sheet should be reviewed for errors and any needed corrections noted. The pretrial investigation officer should consult the accused, counsel, and the legal officer of the convening authority to set up a specific hearing date.

Hearing Date

Once the preheating preparation has been completed, the pretrial investigation officer should convene the hearing. The pretrial investigation is a public hearing and should be held in a place suitable for a quasi-judicial proceeding. All parties should be present; the accused, lawyers, a reporter (if one is used), and witnesses. But witnesses must be examined one-by-one, and no witness should be permitted to hear another testify.

Witnesses

All reasonably available witnesses necessary for a thorough and impartial investigation are required to be called before the Article 32 investigation. Transportation and per diem expenses are provided for both military and civilian witnesses. Witnesses are "reasonably available" and must testify when the significance of the testimony outweighs the difficulty, expense, delay, and effect on military operations. This balancing test means, therefore, as the importance of the testimony increases, a greater difficulty, expense, delay, or effect on military operations can be withstood. Similar considerations apply to the production of documentary and real evidence.

For both military and civilian witnesses, the pretrial investigation officer makes the initial determination concerning availability. For military witnesses, the immediate commanding officer of the witness may overrule the pretrial investigation officer's determination. The decision not to make a witness available is subject to review by the military judge at trial.

A civilian witness whose testimony is material must be invited to testify. But he or she cannot be subpoenaed or otherwise compelled to appear at the investigation. Thus, the pretrial investigation officer should make a bona fide effort to have such civilian

witnesses appear voluntarily, offering transportation expenses and a per diem allowance.

Statements

The pretrial investigation officer has a number of alternatives to live testimony. When a witness is not reasonable available, and even if the defense objects, the pretrial investigation officer may consider sworn statements of witnesses. Unless the defense objects, a pretrial investigation officer may also consider, regardless of the availability of the witness, sworn and unsworn statements, prior testimony, and offers of proof of expected testimony of that witness.

Upon objection, only sworn statements may be considered. Since objections to unsworn statements are generally made, every effort should be made to get sworn statements. All statements considered by the pretrial investigation officer should be shown to the accused and counsel. The same procedure should be followed with respect to documentary and real evidence.

Testimony

All testimony given at the pretrial investigation must be given under oath and is subject to cross-examination. The accused has the right to offer either sworn or unsworn testimony. Also, the statements of witnesses who testify at the hearing should be obtained under oath if undue delay will not result. For this purpose, the pretrial investigation officer is authorized to administer oaths.

Rules of Evidence

The rules of evidence applicable to trial by court-martial do not strictly apply at a pretrial investigation. And the pretrial investigation officer need not rule on objections raised by counsel except in procedural matters. This normally means that objections of counsel are merely noted on the record. Since the rules of evidence do not strictly apply, cross-examination of witnesses maybe very broad and searching and should not be unduly restricted.

Post-hearing Procedures

After the hearing is completed, the investigating officer's report (DD Form 457) is prepared and submitted to the commanding officer who directed the investigation. The commanding officer considers the investigating officer's recommendation as to

disposition, but may dispose of the charges as he or she sees fit. If the commanding officer deems a general court-martial is appropriate but lacks the authority to convene such a court-martial, then the report must be forwarded to the area coordinator unless otherwise directed from the general court-martial convening authority in the commanding officer's chain of command.

Forwarding of the report is accomplished by endorsement that includes the recommendation of the officer directing the pretrial investigation, the recommendations of the investigating officer, a detailed chronology of events in the case, and any comments deemed appropriate. A sample endorsement is shown in figure 5-3.

If the command who ordered the investigation is also a general court-martial convening authority, he or she may refer the case to trial by general court-martial if the charges are warranted by the evidence and such disposition is appropriate.

Pretrial Advice

Before a case is referred to a general court-martial, the convening authority's staff judge advocate must review the case and prepare a written legal opinion on the sufficiency of the evidence and advisability of trial. This written legal opinion is referred to as the pretrial advice.

The pretrial advice of the staff judge advocate includes a written and signed statement of the following:

- Whether each specification on the charge sheet alleges an offense under the UCMJ
- Whether each allegation is substantiated by the evidence indicated in the Article 32 report of investigation
- Whether a court-martial would have jurisdiction over the accused and the offense(s)

<p>DEPARTMENT OF THE NAVY Naval Education and Training Program Management Support Activity Pensacola, Florida 32509</p>	
<p>17 April 19CY</p>	
<p>FIRST ENDORSEMENT on LCDR Jack R. Frost, JAGC, USN Investigating Officer's Report of 13 April CY</p>	
From:	Commanding Officer, Naval Education and Training Program Management Support Activity
To:	Chief of Naval Education and Training
Subj:	ARTICLE 32 INVESTIGATION ICO SEAMAN ABLE B. SEAMAN, USN, 111-11-1111
<ol style="list-style-type: none">1. Forwarded.2. Recommend trial by general court-martial.	
<p>PAUL T. BOATE</p>	

Figure 5-3.—Sample endorsement on Article 32 investigating officer's report.

- A recommended action to be taken by the convening authority

The staff judge advocate is personally responsible for the pretrial advice and must make an independent and informed appraisal of the charges and evidence in order to render the advice. Another person may prepare the advice, but the staff judge advocate is responsible for it and must sign it personally.

The advice need not set forth the underlying analysis or rationale for its conclusions. Ordinarily, the charge sheet, forwarding letter and endorsements, and report of investigation are forwarded with the pretrial advice. When appropriate, the pretrial advice should include a brief summary of the evidence, discussion of significant aggravating, extenuating, or mitigating factors, and any other recommendations. There is no legal requirement to include such information, however, and the failure to do so is not an error. Lastly, it should be noted that the legal conclusions reached by the staff judge advocate are binding on the convening authority, whereas the recommendation is not.

GENERAL COURTS-MARTIAL-TRIAL PROCEEDINGS

As you have just learned, there are prerequisites to convening a general court-martial. Once an Article 32 investigation has been conducted and a case is referred to a general court-martial, the actual procedure is the same as that of a special court-martial. However, there are some differences in composition and qualification of parties.

Who May Be Tried

A general court-martial may try any person subject to the *UCMJ* for any offense made punishable under the code. General courts-martial may also try any person for a violation of Articles 83, 104, and 106. Upon a finding of guilty of an offense, general court-martials may, within limits prescribed in the *MCM*, adjudge any punishment authorized under R.C.M. 1003.

The Death Penalty

The death penalty may not be adjudged if not specifically authorized for the offense, or if the case has been referred as noncapital. A general court-martial composed only of a military judge may not try any person for a capital offense, again, unless

the case has been referred as noncapital. In essence, this means the death penalty may not be ordered by a military judge alone, it must be imposed by a court composed of members.

The Military Judge

The military judge of a general court-martial is designated for such duties by the Judge Advocate General, certified for duty as a military judge of a general court-martial and is assigned and directly responsible to the Judge Advocate General.

Who May Serve

There is no special requirement for a person to act as a member in a general court-martial. But in the general court-martial there must be a minimum of five members appointed. And if the accused elects to be tried by a court composed of enlisted members, then the general court must consist of at least two enlisted members.

The Defense Counsel

The requirement for a defense counselor associate to be certified under Article 27(b), *UCMJ* is the same in both the special and general court-martial. However, in the special court-martial the trial counsel need only be a commissioned officer, whereas in a general court-martial the trial counsel must be a person certified by the Judge Advocate General to perform such duties.

COURTS-MARTIAL PUNISHMENTS

LEARNING OBJECTIVES: Define authorized punishments and identify the primary references for punishment authority. Explain when increased punishments are allowed, and describe maximum punishments and prohibited punishments.

Articles 19,55, and 56, *UCMJ*, R.C.M. 1003 and appendix 12, and Part IV, *MCM*, 1984 are the primary references concerning punishment authority. Part IV of the *MCM* contains the maximum permissible punishment for a particular offense. The other references further limit punitive authority, depending on the level of court-martial and type of punishment being considered.

AUTHORIZED PUNISHMENTS

Punishments are determined by statutory provisions or by the President of the United States under the authority delegated by Article 56, *UCMJ*. An accused, as a general rule, may be separately punished for each offense convicted, unlike non-judicial punishment where only one punishment is imposed for all offenses. Thus, an accused convicted of unauthorized absence (Art. 86), assault (Art. 128), and larceny (Art. 121) is subject to a maximum sentence determined by totaling the maximum punishment for each offense. Summary court-martial punishments were discussed earlier as part of the

advice to the accused. Table 5-1 illustrates authorized punishments for all three types of courts-martial. Now let's consider some of the punishments listed in table 5-1.

Bad-Conduct Discharge

A special court-martial is empowered to sentence an enlisted accused to separation from the service with a bad-conduct discharge (BCD). This is true provided the discharge is authorized for one or more of the offenses for which the accused stands convicted, or by virtue of an escalator clause (discussed later). A special court-martial is not authorized to sentence any

Table 5-1.—Authorized Punishments.

Punishment	Summary		Special		General		
	E-4 & Below	E-5 & Above	E n l i s t e d	O f f i c e r	E n l i s t e d	W a r r n t	O f f i c e r
Death	No	No	No	No	¹ Yes	¹ Yes	¹ Yes
Dismissal	No	No	No	No	No	No	Yes
Dishonorable Discharge	No	No	No	No	Yes	Yes	No
Bad-Conduct Discharge	No	No	Yes	No	Yes	No	No
Confinement	30 days	No	6 mo	No	⁵ Yes	⁵ Yes	⁵ Yes
Solitary Confinement	No	No	No	No	No	No	No
Confinement on bread and water or diminished rations	² 3 days	No	² 3 days	No	² 3 days	No	No
Restriction	2 mo	2 mo	2 mo	2 mo	2 mo	2 mo	2 mo
Hard labor w/o confinement	45 days	No	3 mo	No	3 mo	No	No
Forfeiture all pay and allowances	No	No	No	No	Yes	Yes	Yes
Forfeiture 2/3 pay per month	³ 1 mo	³ 1 mo	6 mo	6 mo	⁵ Yes	Yes	Yes
Fine	⁴ Yes	⁴ Yes	⁴ Yes	⁴ Yes	Yes	Yes	Yes
Reduction to next inferior rate	Yes	Yes	Yes	No	Yes	No	No
Reduction to lowest paygrade	Yes	No	Yes	No	Yes	No	No
Loss of numbers	No	No	No	Yes	No	Yes	Yes
Reprimand	Yes	Yes	Yes	Yes	Yes	Yes	Yes

¹ Where authorized or mandatory

² If attached to or embarked in a naval vessel

³ May extend payment up to 3 months (JAGMAN, 0019b)

⁴ If given, a fine or a fine and forfeiture combination may not exceed the maximum amount of forfeiture which may be adjudged in a case

⁵ Maximum punishment listed for each offense in Part IV, MCM

officer or warrant officer to separation from the service. A BCD is a separation from the service under other than honorable conditions, and is designed as a punishment for bad conduct rather than as a punishment for serious military or civilian offenses. It is also appropriate for an accused who has been convicted repeatedly of minor offenses and whose punitive separation appears necessary.

The practical effect of this type of separation is less severe than a dishonorable discharge, where the accused automatically becomes ineligible for almost all veteran's benefits. The effect of a BCD on veteran's benefits depends upon whether it was adjudged by a general or a special court-martial, whether the benefits are administered by the service concerned or by the Veteran's Administration, and upon the particular facts of a given case.

Confinement

Confinement involves the physical restraint of an adjudged service member in a brig, jail, or prison. Under military law confinement automatically includes hard labor, but the law prefers that the sentence be stated as confinement, omitting the words *at hard labor*. Omission of the words *hard labor* does not relieve the accused of the burden of performing hard labor. A special court-martial can adjudge 6 months' confinement upon an enlisted service member, but may not impose any confinement upon an officer or warrant officer. Part IV, *MCM*, limits this punishment to an even lesser period for certain offenses. As an example, failure to go to appointed place of duty (Art. 86) has a maximum confinement punishment of only 1 month.

Confinement on Bread and Water/Diminished Rations

As its name suggests, this punishment involves confinement coupled with a diet of bread and water or diminished rations. When on a diet of bread and water, the accused is allowed as much bread and water as he or she wants. Diminished rations is food from the regular daily rations, constituting a nutritionally balanced diet, but limited to 2100 calories per day. No hard labor may be required to be performed by an accused undergoing this punishment. Confinement on bread and water/diminished rations may be imposed only upon enlisted persons in paygrades E-1 to E-3 who are attached to or embarked in a vessel, and then for a maximum of only 3 days. Both the prisoner and

the confinement facility must be inspected by a medical officer who must certify in writing that the punishment will not be injurious to the accused's health and that the facility is medically adequate for human habitation.

Restriction

Restriction is a moral restraint upon the accused to remain within certain specified limits for a specified time. Restriction may be imposed on all persons subject to the *UCMJ*, not to exceed 2 months. Restriction is a less severe form of punishment than confinement or hard labor without confinement, and may be combined with any other punishment. The performance of military duties can be required while an accused is on restriction.

Hard Labor Without Confinement

This form of punishment is performed in addition to routine duties and may not lawfully be used in lieu of regular duties. The number of hours per day and character of the hard labor will be designated by the immediate commanding officer of the accused. The maximum amount of hard labor that can be adjudged at a special court-martial is 3 months. This punishment can be imposed on enlisted personnel, but not officers or warrant officers. After each day of hard labor, the accused should then be permitted normal liberty or leave. Hard labor means rigorous work but not so rigorous as to be injurious to health. Hard labor cannot be required on Sundays, but may be performed on holidays. Hard labor can be combined with any other punishment.

Forfeiture of Pay

This kind of punishment involves withholding a specified amount of pay for a specific number of months. The maximum amount that is subject to forfeiture at a special court-martial is two-thirds of 1 month's pay per month for 6 months. The forfeiture must be stated in terms of pay per month for a certain number of months. The basis for computing the forfeiture is the base pay of the accused plus sea and foreign duty pay. Other pay and allowances cannot be considered for forfeiture. If the sentence is to include reduction in grade, the forfeiture must be based upon the grade to which the accused is to be reduced. A forfeiture may be imposed by a special court-martial upon all military personnel. The forfeiture applies to pay becoming due after the forfeitures have been

imposed and not to monies already paid to the accused. Unless suspended, forfeitures take effect on the date executed by the convening authority.

Fine

A fine is a lump sum judgment against the accused requiring him or her to pay money to the United States. A fine is not taken from the accruing pay, as with forfeitures, but becomes due in one payment when the sentence is executed. To enforce collection, a fine may also include the provision that in the event the fine is not paid, the accused must be confined for a period of time. The total period of confinement may not exceed the jurisdictional limit of the specified court-martial should the accused fail to pay the fine. While a special court-martial can impose a fine upon all personnel, the punishment should not be adjudged unless the accused has been unjustly enriched by his or her crimes. A fine cannot exceed the total amount of money that the court could have required to be forfeited. The court may, however, award both a fine and forfeitures, so long as the total monetary punishment does not exceed the amount that could have been required to be forfeited.

Reduction in Grade

Reduction in grade takes away the paygrade of an accused and places him or her in a lower paygrade. Therefore, this punishment can only be used against enlisted persons in other than the lowest paygrade. Officers may not be reduced in grade. A special court-martial may reduce an enlisted service member to the lowest paygrade regardless of grade before sentencing. A reduction can be combined with all other forms of punishment.

In accordance with the power granted in Article 58(a), *UCMJ*, the Secretary of the Navy has determined that automatic reduction will be effected in accordance with JAGMAN 0152d. Under the provisions of this section, a court-martial sentence of an enlisted member (in a paygrade above E-1), that includes a punitive discharge or confinement in excess of 90 days or 3 months automatically reduces the member to the paygrade of E-1 as of the date the sentence is approved. The convening authority or supervisory authority may retain the accused in the paygrade held at the time of sentence or at an intermediate paygrade and suspend the automatic reduction to paygrade E-1. Additionally, the convening authority may direct that the accused serve in paygrade E-1 while in confinement, but be returned

to the paygrade held at the time of sentencing or an intermediate paygrade upon release from confinement. Failure of the convening authority to address automatic reduction will result in the automatic reduction to paygrade E-1.

Loss of Numbers

The dropping of an officer a stated number of places on the lineal precedence list is called loss of numbers. Lineal precedence is lost for all purposes except consideration for promotion. This exception prevents the accused from avoiding or delaying being passed over. Loss of numbers does not reduce an officer in grade, nor does it affect pay or allowances. Loss of numbers may be adjudged in the case of commissioned officers, warrant officers, and commissioned warrant officers. This punishment may be combined with all other punishments.

Punitive Reprimand

A special court-martial may also adjudge a punitive reprimand against anyone subject to the *UCMJ*. A reprimand is nothing more than a written statement criticizing the conduct of the accused. In adjudging a reprimand, the court does not specify the wording of the statement but only its nature. JAGMAN 0152c contains guidance for drafting the reprimand.

CIRCUMSTANCES PERMITTING INCREASED PUNISHMENTS

There are three situations in which the maximum limits of Part IV, *MCM*, may be exceeded. These are known as the "escalator clauses" and are designed to permit a punitive discharge in cases involving chronic offenders. In no event, however, may the so-called escalator clauses operate to exceed the jurisdictional limits of a particular type of court-martial. With respect to a special court-martial, these three clauses have the following impact.

Three or More Convictions

If an accused is convicted of an offense for which Part IV, *MCM*, does not authorize a dishonorable discharge, proof of three or more previous convictions by court-martial during the year preceding the commission of any offense of which the accused is convicted will allow a special court-martial to adjudge a bad conduct discharge, forfeiture of 2/3 pay per

month for 6 months and confinement for 6 months, even though that much punishment is not otherwise authorized. In computing the 1-year period, any unauthorized absence time is excluded.

Two or More Convictions

If an accused is convicted of an offense for which Part IV, *MCM*, does not authorize a punitive discharge, proof of two or more convictions within 3 years preceding the commission of any of the current offenses will authorize a special court-martial to adjudge a bad conduct discharge, forfeiture of 2/3 pay per month for 6 months, and, if the confinement authorized by the offense is less than 3 months, confinement for 3 months. For purposes of the second escalator clause, periods of unauthorized absence are excluded in computing the 3-year period.

Two or More Offenses

If an accused is convicted of two or more separate offenses, none of which authorizes a punitive discharge, and if the authorized confinement for these offenses totals 6 months or more, a special court-martial may adjudge a bad-conduct discharge and forfeiture of 2/3 pay per month for 6 months.

JURISDICTIONAL MAXIMUM PUNISHMENT

In no case can a special court-martial lawfully adjudge a sentence in excess of a bad conduct discharge, confinement for 6 months, forfeiture of 2/3 pay per month for 6 months, and reduction to paygrade E-1. But there are many lesser forms of punishment within these limits that may be adjudged.

PROHIBITED PUNISHMENTS

Article 55, *UCMJ*, flatly prohibits flogging, branding, marking, tattooing, the use of irons (except for safekeeping of prisoners), and any other cruel and unusual punishment. Other punishments not recognized by service customs include shaving the head, tying up by hands, carrying a loaded knapsack, placing in stocks, loss of good conduct time (a strictly administrative measure), and administrative discharge.

DEMEANOR ON WITNESS STAND

LEARNING OBJECTIVES: Identify 12 suggestions offered to help you conduct yourself properly on the witness stand. Explain the purpose of 11 tactics used by counsel, and give an example of each and your response.

As a Master-at-Arms, you undoubtedly will be called upon to testify in court. Remember that a court expects a more precise account from a patrolperson or investigator than from other witnesses. The following suggestions are offered to help you conduct yourself so that you will feel at ease and can direct all your efforts toward presenting your testimony:

- Wear the proper uniform.
- Be punctual.
- Remain calm; don't permit yourself to get confused or upset.
- Tell the truth; don't conceal any facts concerning inquiries about the case.
- You can testify only to what you know to be fact. Hearsay is secondhand information; it is not what you know personally, but what someone else told you.
- Tell your story in your own way. Use plain language that is within the everyday experience and vocabulary of the members of the court or jury. Speak slowly, clearly, and distinctly. Always try to convey thoughts or pictures (not just words) to the court.
- If you make a mistake, no matter how slight, correct it. This method may save you much embarrassment later if the testimony of other witnesses differs from yours.
- Your attitude toward the court should always be respectful. Do not regard the lawyer who cross-examines you as the enemy.
- Remember: There is no hurry; take your time while testifying. The judge and members of a court-martial are anxious to hear what you have to say. They need all the information you can give.
- Limit your answers to the questions asked; do not volunteer information. Don't talk too much.

- Keep your wits about you so you won't make mistakes and get fouled up on cross-examination. The opposing lawyer probably will make you repeat your testimony, hoping you will contradict or discredit your earlier statements. Know the facts, testify to them, and do not change your testimony.
- Before you appear in court, carefully review what you know about the case, run over the facts, and mentally arrange them in proper sequence. As a result, you will be more confident of your ability to do a good job.

Some common tactics used by defense counsels during cross-examinations and the actions you should take are included in table 5-2.

MASTER-AT-ARMS DUTIES AT COURTS-MARTIAL, AND COURTS OF INQUIRY

LEARNING OBJECTIVES: Describe the usual duties of Master-at-Arms at courts-martial and courts of inquiry.

There are no prescribed duties for Masters-at-Arms at courts-martial or courts of inquiry. Usually each command sets its own procedures and directives for personnel assigned.

The following are some of the duties you may encounter and with which you should be familiar.

GUARDING PRISONERS

You may be assigned duties of guarding military prisoners in court. When performing this duty, station yourself in a position so you can observe the prisoner at all times. Remain close enough to prevent the prisoner from injuring himself or others. You may also be required to ensure that the accused, witnesses, and interested parties are present. There may be times you will be stationed outside the courtroom, summoning witnesses. In either instance, remain alert and ensure that quiet is maintained in the immediate area.

When appropriate, a guard is detailed to ensure proper custody of the accused and to assist the court in preserving order and decorum. Unless otherwise directed by the trial judge, guards are not permitted inside the bar of the courtroom. Arms or weapons, except when they are to be exhibits or when otherwise

authorized by the trial judge, are not allowed inside the courtroom.

Prisoners being tried may be delivered in handcuffs if circumstances warrant. If so, the cuffs are removed during the proceedings.

Upon completion of the court and depending on the sentence awarded, the MA may take charge of the accused immediately upon sentencing.

Arrangements for the location of witnesses and the placement of the Master-at-Arms should be coordinated with the trial counsel.

COURT BAILIFF

Masters-at-Arms may also be assigned to duties of a court bailiff. A bailiff should be present at every trial to announce the opening and closing of the court, to obtain witnesses as they are called to testify, to ask everyone to rise when the trial judge enters or leaves the courtroom, and to take care of administrative errands during the trial. The trial counsel is responsible for briefing the bailiff as to his or her duties.

Duties of the Bailiff

The bailiff may look to the trial counsel for specific instruction as to his or her duties and for directions before and after each session of the court. While the court is in session, the bailiff is under the supervision of the military judge and will assist the military judge and counsel in the conduct of an orderly trial. The bailiff should be familiar with the location of the principal offices and facilities, such as the library, within the law complex.

The following is a list of the duties of a court bailiff:

- The bailiff reports to the trial counsel in the uniform of the day with duty belt and appropriate cover at least 30 minutes before the beginning of each day's proceedings. Thereafter the bailiff reports to the military judge 15 minutes before the beginning of the day's proceedings.
- The bailiff sees that the courtroom, including the spectator area and the deliberation room for court members, has a neat and orderly appearance and will arrange the furniture properly.

Table 5-2.—Cross Examination Tactics

<u>COUNSEL'S TACTIC</u>	<u>EXAMPLE</u>	<u>PURPOSE</u>	<u>YOUR RESPONSE</u>
Rapid fire questions	One question after another with little time to answer.	To confuse you; an attempt to force inconsistent answers.	Take time to consider the question; be deliberate in answering; ask to have the question repeated; remain calm.
Condescending counsel	Benevolent in approach, over-sympathetic in his or her questions to the point of ridicule.	To give the impression that you are inept, lack confidence, or may not be a reliable witness.	Firm decisive answers, asking for the question to be repeated if improperly phrased.
Friendly counsel	Very courteous, polite; questions tend to take you into his or her confidence.	To lull you into a false sense of security where you will give answers in favor of the defense.	Stay alert, bear in mind that the purpose of defense is to discredit or diminish the effect of your testimony.
Badgering, beligerent	Counsel staring you right in the face, shouts, "That is so, isn't it?"	To make you angry so that you lose your sense of logic and calmness. Generally, rapid questions will also be included in this approach.	Stay calm, speak in a deliberate voice giving trial counsel time to make appropriate objections.
Mispronouncing your name; using wrong rank	Your name is Jansen; counsel calls you Johnson.	To draw your attention to the error in pronunciation rather than enabling you to concentrate on the question asked so that you will make inadvertent errors in testimony.	Ignore the mispronouncement and concentrate on the question counsel is asking.
Suggestive question (tends to be a leading question allowable on cross-examination).	Was the color of the car blue?	To suggest an answer to counsel's question in an attempt to confuse or to lead you.	Concentrate carefully on the facts, disregard the suggestion. Answer the question.
Demanding a "yes" or "no" answer to a question that needs explanation.	Did you strike the defendant with your club?	To prevent all pertinent and mitigating details from being considered by the jury.	Explain the answer to the question, if stopped by counsel demanding a "yes" or "no" answer, pause until the court instructs you to answer in your own words.
Reversing your words	You answer, "The accident occurred 27 feet from the intersection." Counsel says, "You say the accident occurred 72 feet from the intersection?"	To confuse you and demonstrate a lack of confidence in you.	Listen intently whenever counsel repeats back something you have said. If he makes an error, correct him.
Repetitious questions	The same question asked several times slightly rephrased.	To obtain inconsistent or conflicting answers from you.	Listen carefully to the question and state, "I have just answered that question."
Conflicting answers	But, Petty Officer Smith, Chief Brown just said, etc.	To show inconsistency in the investigation. This tactic is normally used on measurements, times, etc.	Remain calm. Conflicting statements have a tendency to make a witness extremely nervous. Be guarded in your answers on measurements, times, etc. Unless you have exact knowledge, use the term "approximately". Refer to your notes.
Staring	After you have answered, counsel just stares as though there were more to come.	To have a long pause that one normally feels must be filled thus saying more than necessary. To provoke you into offering more than the question called for.	Wait for the next question.

- The bailiff ensures that the judge has the desk supplies desired and that the court members have pencils and pads of voting paper in their deliberation room.

- When counsel for both sides, the accused, the reporter, and, when appropriate, the court members, are all present in the courtroom, the bailiff notifies the military judge and escorts him or her to the courtroom. When entering the courtroom, the bailiff states: "All persons please rise." When the military judge announces a recess or adjournment, the bailiff again states: "All persons please rise." If need be, he or she will also instruct the spectators to stand fast until the military judge has departed from the courtroom. The military judge will advise the bailiff in the event there is to be any departure from this procedure.

- According to the instructions of the military judge, the court will be formally opened at the beginning of each day of the trial at which spectators are in attendance. On those occasions, the bailiff states:

All persons please rise. A (general) (special) court-martial convened by _____ is now in session, Military Judge (Captain) (Colonel) (Commander) () U.S. (Navy) (Marine Corps) presiding.

- When the court members enter the courtroom and also when the court members stand to be sworn, the bailiff will announce, "Everyone, please stand," in a voice that can be heard by all spectators (unless advised of a different procedure by the judge).

- The bailiff should be aware that military trials are open and that spectators and members of the news media are welcome in the courtroom to hear and observe the trial proceedings (unless otherwise instructed by the judge). The bailiff should see that they can enter the courtroom, be seated, and leave quietly while the court is in session.

- As the law does not permit picture taking or any type of broadcasts in the courtroom, the bailiff will not permit that type of equipment to be taken into the courtroom. Any problems concerning this matter should be brought to the attention of the trial counsel.

- Courtroom rules do not permit spectators to eat, sleep, smoke, or engage in conversation while the court is in session. The bailiff should quietly and diplomatically inform the offenders of these rules.

- Anyone talking or making noise in the halls that distracts from the proceedings in the courtroom will be told by the bailiff that court is in session.

- Rowdiness and violence are not unknown in the courtroom. The bailiff must be alert and prepared to take immediate steps to suppress unruly behavior.

- When the court members are in closed session, only the members may be permitted in the deliberation room. Therefore, the bailiff will not enter that room or permit anyone else to enter during the closed session.

- The bailiff is the only contact between the court members and the parties to the trial during the periods the court members are deliberating. The bailiff will be available to the court members outside their deliberation room and immediately notify the trial counsel, defense counsel, and military judge when the court members are ready for the court to be reopened.

- If the bailiff is instructed to deliver any item or message to the court members in closed session, he or she first informs the judge and obtains approval.

Services of Bailiff

The bailiff will be prepared to furnish the following services:

- Summon the court members to the courtroom at the beginning of each session of court when advised by the military judge or trial counsel.

- Collect written questions from the court members upon the judge's request and hand them to the judge or trial counsel as instructed.

- Summon witnesses to the courtroom when requested by counsel.

- Deliver findings and sentence worksheets to the president of the court when instructed to do so.

- Deliver items of evidence to the deliberation room, if instructed to do so by the military judge, when the court members retire to the deliberation room.

- Perform administrative errands during the trial as requested by the military judge and trial and defense counsel.

Conduct of Bailiff

The bailiff should remain neutral throughout the trial of a case and not assume a partisan attitude toward either the prosecution or the defense. The bailiff should never participate in any discussion of the merits of the case or attempt to predict the outcome of the trial. The bailiff should also avoid making any

comments on the performance of counsel for either side or on the testimony of witnesses.

CIVIL COURT LIAISON

LEARNING OBJECTIVES: List and explain the duties of a civilian court liaison.

Depending on the size, location, and number of cases handled, Masters-at-Arms may be assigned to a civil court. The purpose of this assignment is to establish and maintain a good working relationship between armed forces personnel and civilian law enforcement agencies and the court.

Duties of civilian court liaison include:

- Learn of civilian offenses committed by military personnel, using all available resources
- Initiate reports as required; e.g., original reports on cases not reported to the patrol section plus needed supplemental reports
- Maintain a working file on each open case; ensure the destruction of each working file as a case is closed
- Place military detainees on service personnel confined by civil authorities who have military charges pending

- Attend sessions of criminal and traffic courts whenever military offenders are tried and provide assistance to civil court and law enforcement personnel
- Accept custody of military personnel released by civil authorities and make appropriate disposition
- Keep concerned units advised of the status of those in civil confinement
- Act as liaison between individuals in confinement and the military
- Maintain a written record of visits made and units notified

SUMMARY

In this chapter, we looked at the three different types of courts-martial, their creation, and the duties and qualifications of the personnel involved. We also covered advice to the accused regarding rights and right of counsel. Punishments that can be awarded in each court were covered, along with prohibited punishments. Suggestions for Master-at-Arms to improve their performance on the witness stand were given. Finally, the usual duties of Master-at-Arms at courts-martial and courts of inquiry were discussed, as well as the duties of a civilian court liaison.

CHAPTER 6

NONJUDICIAL PUNISHMENT

As a Master-at-Arms (MA), you will be involved with all aspects of nonjudicial punishment (NJP). NJP is better known in the Navy as *captain's mast*, or just *mast*, a term from the early sailing days when the usual setting for this type of naval justice was on the weather deck at the front of the ship's mainmast. In this chapter, we will discuss the duties and procedures required before, during, and after NJP proceedings.

Both commanding officers (COs) and officers in charge (OICs) can conduct mast. For a discussion on the differences between masts held by COs and OICs, see Article 15, *Uniform Code of Military Justice* (UCMJ) and part V of the *Manual for Courts-Martial* (MCM).

The terms *nonjudicial punishment* and *NJP* are used interchangeably. They refer to certain limited punishments that can be awarded for minor disciplinary offenses by a CO to members of command.

Article 15 of the UCMJ, part V of the MCM, and part B of chapter 1 of *The Manual of the Judge Advocate General* (JAGMAN) cover the basic law on NJP procedures. The legal protection afforded an individual subject to NJP proceedings is more complete than is the case for nonpunitive measures, but, by design, is less extensive than for courts-martial. Unlike courts-martial, NJP is nonadversarial in nature. When punishment is imposed it is not considered a conviction, and when a case is dismissed it is not considered an acquittal.

The word *mast also* is used to describe three different types of proceedings: request mast, meritorious mast, and disciplinary mast. Request mast is a hearing before the CO, at the request of a member, for making requests, reports, statements, and for airing grievances. Meritorious mast is for the purpose of publicly and officially commending a member of the command for noteworthy performance of duty. This chapter discusses disciplinary mast.

Mast is a procedure where the CO may (1) inquire into the facts surrounding minor offenses allegedly committed by a member of their command; (2) afford the accused a hearing as to the offense(s); and (3) dispose of such charges by dismissing the charges,

imposing punishment, or referring the case to a court-martial.

NATURE AND REQUIREMENTS FOR NONJUDICIAL PUNISHMENT (NJP)

LEARNING OBJECTIVES: Identify who may impose NJP and persons on whom NJP may be imposed. Explain the right to trial by court-martial. Discuss punishments under Article 15, in terms of circumstances surrounding the offense, cases previously tried, and off-base offenses.

Nonjudicial punishment is a disciplinary measure more serious than administrative corrective measures, but less serious than trial by court-martial. Nonjudicial punishment provides commanders with an essential and prompt means of maintaining good order and discipline and also promotes positive behavior changes in service members without the stigma of a court-martial conviction.

WHO MAY IMPOSE

Authority to impose nonjudicial punishment under Article 15, UCMJ, may be exercised by a CO, an OIC, or by certain officers to whom the power has been delegated by the Secretary of the Navy (SECNAV).

In the Navy and Marine Corps, billet designations by the Bureau of Naval Personnel and Headquarters Marine Corps identify those persons who are COs. So the term *commanding officer* has a precise meaning and is not used arbitrarily.

An OIC is a commissioned officer appointed by departmental orders, tables of organization, manpower authorizations, orders of a flag or general officer in command, or orders of the senior officer present.

The power to impose NJP is inherent in the office and not in the individual. Thus, the power may be exercised by a person acting as CO, such as when the

CO is on leave and the executive officer (XO) succeeds to command.

Ordinarily, the power to impose NJP cannot be delegated. But one exception is when a flag or general officer delegates all or a portion of his or her Article 15 power to a principal assistant. A principal assistant is a senior officer on a flag or general officer's staff who is eligible to succeed to command. This delegation must be made with the express approval of the Chief of Naval Personnel or the Commandant of the Marine Corps.

Another exception exists when members of the naval service are assigned to a multiservice command. The commander of a multiservice command may appoint one or more naval units and for each unit designate a naval commissioned officer as CO for NJP purposes over the unit. A copy of such designation must be furnished to the Commander, Naval Military Personnel Command or the Commandant of the Marine Corps, as appropriate, and to the Judge Advocate General.

No officer may limit or withhold the exercise of any disciplinary authority under Article 15 by subordinate commanders without the specific authorization of SECNAV.

If a CO determines that his or her authority under Article 15 is not enough to make a proper disposition of the case, he or she may refer the case to a superior commander for appropriate disposition.

This referral situation could arise either when the CO's NJP powers are less extensive than those of the superior officer, or when the status of higher authority would add force to the punishment, as in the case of a letter of reprimand or admonition.

PERSONS SUBJECT TO NJP

A CO may impose NJP on all military personnel of his or her command. An OIC may impose NJP only upon enlisted members assigned to his or her unit.

At the time punishment is imposed, the accused must be a member of the command of the CO (or of the unit of the OIC) who imposes the NJP. A person is "of the command or unit" if he or she is assigned or attached to it. This includes temporary additional duty (TAD) personnel. Personnel on TAD may be punished either by the OIC of the TAD unit to which they are assigned, or by the CO of the duty station to which they are permanently attached. Note, however, that both the OIC and the CO cannot punish an individual

under Article 15 for the same offense. In addition, a party to a *JAG Manual* investigation remains of the command or unit that he or she was attached to at the time of his or her designation as a party for the sole purpose of imposing a letter of admonition or reprimand as NJP.

Personnel of Another Armed Force

Under present agreements between the armed forces, a Navy CO should not exercise NJP jurisdiction on Army or Air Force personnel assigned or attached to a naval command. As a matter of policy, these personnel should be returned to their parent service for discipline. If this is impractical and the need to discipline is urgent, NJP may be imposed, but a report to the Department of the Army or Department of the Air Force is required. See MILPERSMAN, Article 1860320.5a, 5b, for the procedures to follow.

Express agreements do not extend to Coast Guard personnel serving with a naval command, but as a matter of policy, the naval command should not try to exercise NJP over such personnel assigned to their unit. Refer to section 1-3(c), *Coast Guard Military Justice Manual*, COMDTINST M5801.1.

Because the Marine Corps is part of the Department of the Navy, no general restriction extends to the exercise of NJP by Navy commanders over Marine Corps personnel or by Marine Corps commanders over Navy personnel.

NJP of Embarked Personnel

The CO or OIC of a unit attached to a ship should refrain from exercising his or her power to impose NJP and refer all such matters to the CO of the ship for disposition. This policy does not apply to Military Sealift Command (MSC) vessels operating under masters or to organized units embarked on a Navy ship for transportation only. Nevertheless, the CO of a ship may permit a CO or OIC of a unit attached to that ship to exercise nonjudicial punishment authority.

NJP of Reservists

Reservists on active duty for training, and under some circumstances inactive duty for training, are subject to the UCMJ and are, therefore, subject to the imposition of NJP.

The offense(s) that the CO or OIC seeks to punish at NJP must have occurred while the member was on active duty or inactive duty training. However, it is not

necessary that NJP occur (or the offense even be discovered) before the end of the active duty or inactive duty training period during which the alleged misconduct occurred. When a CO imposes NJP on reservists, the following options apply:

- Impose NJP during the active duty or inactive duty training when the misconduct occurred
- Impose NJP at a later period of active duty or inactive duty training (not to exceed 2 years from the date of the offense)
- Request an involuntary recall of the accused to active duty or inactive duty training to impose NJP from the regular component officer exercising general court-martial jurisdiction over the accused
- Impose NJP after the period of active duty or inactive duty training, if the accused waives the right to be present at the NJP hearing

Punishment imposed on a person who was involuntarily recalled for imposition of NJP may not include restraint unless the SECNAV approves the recall.

Right to Trial by Court-Martial

Article 15a, UCMJ, and part V, par. 3, MCM, 1984, provide another limitation on the exercise of NJP. Except for a person attached to or embarked in a vessel, an accused may demand trial by court-martial instead of NJP.

This right to refuse NJP exists up to the time of imposition of NJP (that is, up until the CO announces the punishment). This right is not waived by the accused having previously signed a report chit showing that he or she would accept NJP.

The category of persons who may not refuse NJP includes those persons assigned or attached to a vessel and those who are on board for passage, or assigned or attached to an embarked staff, unit, detachment, squadron, team, air group, or other regularly organized body.

The key time factor in determining whether or not a person has the right to demand trial by court-martial is the time of the imposition of the NJP and not the time of the commission of the offense. There is no provision for a CO or OIC to impose NJP on a civilian.

OFFENSES PUNISHABLE UNDER ARTICLE 15, UCMJ

Article 15 gives a CO power to punish individuals for minor offenses. The term *minor offense* has been the cause of some concern in the administration of nonjudicial punishment.

Article 15, UCMJ, and part V, par. 1e, MCM, state that the term *minor offense* means misconduct normally not more serious than that usually handled at a summary court-martial (SCM) (where the maximum punishment is 30 days' confinement). These sources also say that the nature of the offense and the circumstances surrounding its commission are also factors that should be considered in determining whether an offense is minor in nature.

The term *minor offense* ordinarily does not include misconduct that, if tried by general court-martial (GCM), could be punished by a dishonorable discharge or confinement for more than 1 year. The Navy and Marine Corps, however, have taken the position that the final determination whether an offense is minor is within the sound discretion of the CO.

Maximum Penalty

To determine if the offense is minor, begin the analysis with a consultation of punitive articles (part IV, MCM, 1984) and determine the maximum punishment for the offense. If the authorized confinement is 30 days to 3 months, the offense is most likely a minor offense, although the MCM does not specifically state this. If the authorized confinement is 6 months to a year, the offense may be minor. However, if authorized confinement is 1 year or more, the offense is usually not minor.

Circumstances Surrounding the Commission of an Offense

The MCM, 1984, also points out that in determining whether an offense is minor, the nature of the offense and the circumstances surrounding its commission should be considered. This is a significant statement and often is misunderstood as referring to the seriousness or gravity of the offense. Gravity refers to the maximum punishment. In contrast, nature of the offense refers to its character, not its gravity.

In military criminal law, there are two basic types of misconduct: disciplinary infractions and crimes.

Disciplinary infractions are breaches of standards governing the routine functioning of society. Thus, traffic laws, license requirements, disobedience of military orders, and disrespect to a military superior are disciplinary infractions. Crimes, on the other hand, involve offenses recognized as particularly evil. Crimes are acts of robbery, rape, murder, aggravated assault, and larceny. Both types of offenses involve a lack of self-discipline, but crimes involve a particular gross absence of selfdiscipline amounting to a moral deficiency. Crimes are the product of a mind particularly disrespectful of good moral standards.

In most cases, criminal acts are not minor offenses. However, they are minor or serious depending upon the circumstances. And thus, while some disciplinary offenses carry severe maximum penalties, the law recognizes that the impact of some of these offenses on discipline will be slight.

The circumstances surrounding the commission of a disciplinary infraction are important to the determination of whether such an infraction is minor. For example, willful disobedience of an order to take ammunition to a unit engaged in combat can have fatal results for those engaged in the combat and is a serious matter. Willful disobedience of an order to report to the barbershop will have much less of an impact. The offense must provide both extremes, and it does because of a high maximum punishment limit.

When dealing with disciplinary infractions, the commander must be free to consider the impact of the circumstance since he or she is considered to be the best judge. However, in disposing of crimes, society at large has an interest coexistent with that of the command, and criminal defendants are given more safeguards. Therefore, the commander's discretion in disposing of disciplinary infractions is much greater than the latitude afforded when dealing with crimes.

The Navy has taken the position that the final determination of what is a minor offense is within the sound discretion of the CO. Imposition of NJP does not, in all cases, prevent a later court-martial for the same offense. See part V, par. 1e, MCM, 1984.

Cases Previously Tried in Civil Court

Although a member may have been previously tried in a civil court he or she may still be subject to military law. Sections 0108b and 0124c(2) of the *JAG Manual* permit the use of nonjudicial punishment to punish an accused for offenses in the following circumstances:

- When tried (whether acquitted or convicted) by a domestic or foreign civilian court
- When diverted out of the regular criminal process for a probationary period
- When adjudicated by juvenile court authorities. This is true only if authority is obtained from the officer exercising general court-martial jurisdiction.

NJP may not be imposed for an act tried by a court that derives its authority from the United States, such as a federal district court.

Cases in which a finding of guilt or innocence has been reached in a trial by court-martial cannot be taken to nonjudicial punishment.

Off-Base Offenses

COs and OICs may dispose of minor off-base disciplinary infractions at NJP. Unless the off-base offense is a traffic violation or one previously adjudicated by civilian authorities, there is no limit on the authority of military commanders to resolve such offenses at NJP.

In areas not under military control, the responsibility for maintaining law and order rests with civil authority. The enforcement of traffic laws falls within the purview of this principle. Off-duty, off-installation driving offenses, however, show inability and lack of safety consciousness. Such driving performance does not prevent the use of nonpunitive measures that could include denial of on-base driving privileges.

THE NJP PACKAGE

LEARNING OBJECTIVES: List the functions of the Report and Disposition of Offenses, NAVPERS 1626/7. Explain how to properly complete the NAVPERS 1626/7.

The NJP package includes numerous documents and forms along with any evidence pertaining to the case. Strict compliance with filling out the forms is essential to a proper nonjudicial punishment proceeding.

REPORT AND DISPOSITION OF OFFENSE(S), NAVPERS 1626/7

Your office can receive notification that an offense has been committed in a variety of ways. These can include a shore patrol report, a verbal complaint by a victim, or a local report chit. Except when serious crimes are involved, charges are reduced to writing on the Report and Disposition of Offense(s), NAVPERS 1626/7, and processed in the manner prescribed by the form itself.

The NAVPERS 1626/7 is a one-sheet (back and front) form. It is not a substitute for a charge sheet and it is not a substitute for the pretrial investigation required by Article 32, UCMJ. However, so long as the offense(s) remains in the group of cases to be handled by the CO at mast, this one form satisfies most paper work requirements of a mast proceeding. Among the functions the NAVPERS 1626/7 serves are the following:

- It reports the offense(s).
- It records that the accused has been advised of his or her rights under Article 31, UCMJ.
- It records any premast restraint.
- It serves as a preliminary inquiry report.
- It records the action of the XO at screening mast.
- It records that the accused has been advised of the right to refuse NJP (if that right exists under the circumstances of the case).
- It shows the action of the CO at mast.
- It records that appeal rights have been explained to the accused.
- It becomes a permanent record of the case in the Unit Punishment Book (UPB). No additional record is needed, such as 3 x 5 cards or a mast logbook.

Remember, however, that the NAVPERS 1626/7 does not include all the required premast advice that must be given to the accused according to section 0109 of the *JAG Manual*.

Regardless of how the commission of a minor offense is brought to your attention, you will probably need to prepare the smooth NAVPERS 1626/7. Figure 6-1 illustrates a completed NAVPERS 1626/7. Let's

look at the information that you will place on this form.

PREPARATION OF NAVPERS 1626/7

Referring to figure 6-1, section A, start with addressing the report to the OIC or CO of the accused. Fill in the date of the report. Type the accused's last name, first name, and middle initial. Type in the accused's social security number, present rate, and branch and class of service. Designate the department or division to which the accused is attached. Fill in the place of the offense. If there is more than one place, list all applicable places of the offense(s). Show the date of the commission of the offense. If there is more than one date, show all dates.

In the section entitled Details of the Offense, it is not mandatory that you type the offenses in the manner that you would on a charge sheet. However, this is good practice. If you always prepare a specification in full detail, you will not have to change it in the event the charges are referred to court-martial.

List military witnesses to the offense in order of seniority, followed by civilian witnesses, if any. If the witnesses are attached to the same command as the offender, it is only necessary to give the witness' division or department. If the witness is attached to another command, identify that command completely. If a witness is a civilian, give the complete address, business and home, if available. Finally, be sure to get the signature of the person placing the accused on report.

Section B of figure 6-1 shows the acknowledgement of the accused as having been informed of the nature of the accusation(s) against him or her and his or her right not to answer any questions relating to the offense. After the accused is formally informed of the accusations against him or her, this section should be signed by the accused and the person informing the accused of his or her right. If the accused refuses to sign this section, that fact must be witnessed by the person informing the accused of the accusations who will sign attesting to that fact.

Section C of figure 6-1 shows any premast restraint of the accused. If the accused is not being restricted, put the entry in the No Restrictions block. On the other hand, if the accused is placed on restriction pending investigation of the charges, you will either mark the Confined for Safekeeping block or the Restricted block. If the Restricted block is used, fill in the restricted to the limits of portion. Be sure to

REPORT AND DISPOSITION OF OFFENSE(S)
NAVPERS 1626/7 (REV. 8-81) S/M 0100-LF-016-2038

To: Commanding Officer, NETPMSA, Pensacola, Florida Date of Report: 25 March 19CY

I hereby report the following named person for the offense(s) noted:

NAME OF ACCUSED	SERIAL NO	SOCIAL SECURITY NO	RATE / GRADE	BR & CLASS	DIV / DEPT
Seaman, Able B.		555-55-5555	BMSA	USN	Base Ops

PLACE OF OFFENSE(S) NETPMSA, Saufley Field, Pensacola, Florida DATE OF OFFENSE(S) 23 March 19CY

DETAILS OF OFFENSE(S) (Refer by article of UCMJ, if known. If unauthorized absence, give following info: time and date of commencement, whether over leave or liberty, time and date of apprehension or surrender and arrival on board, loss of ID card and/or liberty card, etc.):

Charge: Violation of the Uniform Code of Military Justice, Article 121

Specification: In that Boatswain's Mate Seaman Apprentice Able B. Seaman, U.S. Navy NETPMSA, Saufley Field, Pensacola, Florida, on active duty, did, onboard Saufley Field, Pensacola, Florida, on or about 23 March 19CY, steal two \$50.00 bills, the property of BM3 Water T. Door, U.S. Navy.

NAME OF WITNESS	RATE / GRADE	DIV / DEPT	NAME OF WITNESS	RATE / GRADE	DIV / DEPT
Doe, Jane B.	Lt	OPS	Door, Water T.	BM3	OPS
Boat, Paul T.	BMC	OPS			
Pistol, Verv. C	MA1	511			

MAC, USN, Base Security Chief
(Rate/Grade/Title of person submitting report)

Jack R. Frost
 Jack R. Frost
(Signature of person submitting report)

I have been informed of the nature of the of the accusation(s) against me. I understand and I do not have to answer any questions or make any statement regarding the offense(s) of which I am accused or suspected. However, I understand any statement made or questions answered by me may be used as evidence against me in event of trial by court-martial (Article 31 UCMJ).

Witness: John A. Doe, ENS, USN
(Signature)

Acknowledged: Able B. Seaman
(Signature of Accused)

PRE-ARREST RESTRAINT

PRE TRIAL CONFINEMENT

RESTRICTED: You are restricted to the limits of _____

NO RESTRICTIONS

_____ in lieu of arrest by order of the CO. Until your status as a restricted person is terminated by the CO, you may not leave the restricted limits except with the express permission of the CO or XO. You have been informed of the times and places which you are required to muster.

(Signature and title of person imposing restraint)

(Signature of Accused)

INFORMATION CONCERNING ACCUSED

CURRENT ENL DATE	EXPIRATION CURRENT ENL DATE	TOTAL ACTIVE NAVAL SERVICE	TOTAL SERVICE ON BOARD	EDUCATION	GCT	AGE
02 Jan 19CY	02 Jan 1994	3 years 3 months	18 months	12	54	22
MARITAL STATUS	NO. DEPENDENTS	CONTRIBUTION TO FAMILY OR OTHER ALLOWANCE <small>(Amount required by law)</small>		PAY PER MONTH <small>(Including sea or foreign duty pay, if any)</small>		
Married	5	N/A		\$1,250.20		

RECORD OF PREVIOUS OFFENSE(S) (Date, type, action taken, etc. Nonjudicial punishment incidents are to be included.)

19 June 1991

COs NJP

OFFENSE: Viol UCMJ Art. 92 - Failure to obey a lawful order on 16 June 1991.

NJP AWARDED: Restriction for a period of 14 days and extra duty for a period of 14 days

Figure 6-1.—Report and Disposition of Offense(s), NAVPERS 1626/7.

PRELIMINARY INQUIRY REPORT						
From: Commanding Officer To: ENS Floss A. Brush, USN, Supply Department					Date: 26 March 19CY	
1. Transmitted herewith for preliminary inquiry and report by you, including, if appropriate in the interest of justice and discipline, the preferring of such charges as appear to you to be sustained by expected evidence.						
REMARKS OF DIVISION OFFICER (Performance of duty, etc.) BMSA Seaman is a capable and conscientious worker. He has been experiencing financial difficulties which appear to have been the basis of this misconduct.						
NAME OF WITNESS		RATE/GRADE	DIV/DEPT	NAME OF WITNESS		RATE/GRADE DIV/DEPT
Doe, Jane B.		Lt	OPS	Pistol, Very C.		MA1 511
Boat, Paul T.		BMC	OPS	Door, Water T.		BM3 OPS
RECOMMENDATION AS TO DISPOSITION:						
<input checked="" type="checkbox"/> DISPOSE OF CASE AT MAST		<input type="checkbox"/> REFER TO COURT MARTIAL FOR TRIAL OF ATTACHED CHARGES (Complete Charge Sheet (DD Form 458) Through Page 2)			<input type="checkbox"/> OTHER	
COMMENT (Include data regarding availability of witnesses, summary of expected evidence, conflicts in evidence, if expected. Attach statements of witnesses, documentary evidence such as service record entries in UA cases, items of real evidence, etc.)						
Summary of Evidence: Statements of LT Doe, BMC Boat, and MA1 Pistol (enclosures (1), (2), and (3)) state that they saw BMSA Seaman remove the money from the personal desk of BM3 Door. BMC Boat also states that he has personally counseled BMSA Seaman on numerous occasions concerning indebtedness and was aware that BMSA Seaman was experiencing money problems. In view of the seriousness of the offense, <i>Floss A. Brush</i> Floss A. Brush, ENS, USN NJP is recommended.						
ACTION OF EXECUTIVE OFFICER						
<input type="checkbox"/> DISMISSED			<input checked="" type="checkbox"/> REFERRED TO CAPTAIN'S MAST		SIGNATURE OF EXECUTIVE OFFICER Mary N. Christmas, CDR, USN	
RIGHT TO DEMAND TRIAL BY COURT-MARTIAL (Not applicable to persons attached to or embarked in a vessel)						
I understand that nonjudicial punishment may not be imposed on me if, before the imposition of such punishment, I demand in lieu thereof trial by court-martial. I therefore (do) (do not) demand trial by court-martial.						
WITNESS <i>Jack R. Frost</i> Jack R. Frost, MAC, USN			SIGNATURE OF ACCUSED <i>Able B. Seaman</i> Able B. Seaman, BMSA			
ACTION OF COMMANDING OFFICER						
<input type="checkbox"/> DISMISSED		<input type="checkbox"/> DISMISSED WITH WARNING (Not considered NJP)		<input type="checkbox"/> CONF. ON _____, 1, 2, OR 3 DAYS		<input checked="" type="checkbox"/> CORRECTIONAL CUSTODY FOR <u>30</u> DAYS
<input type="checkbox"/> ADMONITION: ORAL/IN WRITING		<input type="checkbox"/> REPRIMAND: ORAL/IN WRITING		<input type="checkbox"/> REST TO _____ FOR _____ DAYS		<input checked="" type="checkbox"/> REDUCTION TO NEXT INFERIOR PAY GRADE
<input type="checkbox"/> REST TO _____ FOR _____ DAYS		<input type="checkbox"/> REST TO _____ FOR _____ DAYS WITH SUSP. FROM DUTY		<input type="checkbox"/> FORFEITURE: TO FORFEIT \$ _____ PAY PER NO. FOR _____ MO(S)		<input type="checkbox"/> EXTRA DUTIES FOR _____ DAYS
<input type="checkbox"/> DETENTION: TO HAVE & _____ PAY PER MO FOR (1, 2, 3) MO(S) DETAINED FOR _____ MO(S)		<input type="checkbox"/> AWARDED SPOM		<input type="checkbox"/> AWARDED SCM		<input type="checkbox"/> PUNISHMENT SUSPENDED FOR _____
<input type="checkbox"/> ART. 32 INVESTIGATION		<input type="checkbox"/> RECOMMENDED FOR TRIAL BY GOM		DATE OF MAST: 02 April 19CY		
DATE ACQUAINTED OF ABOVE ACTION: 02 April 19CY		SIGNATURE OF COMMANDING OFFICER <i>Jon T. Boate</i> Jon T. Boate, CAPT, USN				
It has been explained to me and I understand that if I feel this imposition of nonjudicial punishment to be unjust or disproportionate to the offenses charged against me, I have the right to immediately appeal my conviction to the next higher authority within XXXXXX 5 days.						
SIGNATURE OF ACCUSED <i>Able B. Seaman</i> Able B. Seaman		DATE 02 April 19CY		I have explained the above rights of appeal to the accused. SIGNATURE OF WITNESS J. Doe, MA1, USN DATE 02 April 19CY		
FINAL ADMINISTRATIVE ACTION						
APPEAL SUBMITTED BY ACCUSED DATED: None			FINAL RESULT OF APPEAL:			
FORWARDED FOR DECISION ON _____			APPROPRIATE ENTRIES MADE IN SERVICE RECORD AND PAY ACCOUNT ADJUSTED WHERE REQUIRED			
DATE: 03 April 19CY (Initials)			FILED IN UNIT PUNISHMENT BOOK DATE: 03 April 19CY (Initials)			
NAVPERS 1626/7 (REV. 8-81)(BACK)						

Figure 6-1.—Report and Disposition of Offense(s), NAVPERS 1626/7—Continued.

PRELIMINARY INQUIRY OFFICER'S REPORT

Name of Accused: _____

1. Read paragraph in MCM concerning offenses/charges Yes
2. Witnesses interviewed (not the accused):

	(NAME)	(PHONE)	SIGNED STATEMENT ATTACHED		SUMMARY OF INTERVIEW ATTACHED
a.	_____	_____	<input type="checkbox"/>	or	<input type="checkbox"/>
b.	_____	_____	<input type="checkbox"/>	or	<input type="checkbox"/>
c.	_____	_____	<input type="checkbox"/>	or	<input type="checkbox"/>
d.	_____	_____	<input type="checkbox"/>	or	<input type="checkbox"/>
e.	_____	_____	<input type="checkbox"/>	or	<input type="checkbox"/>
f.	_____	_____	<input type="checkbox"/>	or	<input type="checkbox"/>

3. Accused's supervisor(s) interviewed:

a.	_____	_____	<input type="checkbox"/>	or	<input type="checkbox"/>
b.	_____	_____	<input type="checkbox"/>	or	<input type="checkbox"/>

4. Documentary evidence:

	(ORIG)		(COPY)/(ATTACHED)		(LOCATION)
a.	_____ <input type="checkbox"/>	or	<input type="checkbox"/>	<input type="checkbox"/>	or _____
b.	_____ <input type="checkbox"/>	or	<input type="checkbox"/>	<input type="checkbox"/>	or _____
c.	_____ <input type="checkbox"/>	or	<input type="checkbox"/>	<input type="checkbox"/>	or _____
d.	_____ <input type="checkbox"/>	or	<input type="checkbox"/>	<input type="checkbox"/>	or _____

5. Real evidence:

	(DESCRIPTION)	(NAME OF CUSTODIAN)	(CUSTODIAN'S PHONE)
a.	_____	_____	_____
b.	_____	_____	_____

6. Permit the accused to inspect report chit - - - - - Yes ___ No ___
7. Accused initialed second page of charges (if any) - - - - N/A ___ Yes ___ No ___
8. Accused signed acknowledgement line of NAVPERS 1626/7 - - - Yes ___ No ___
9. Investigator signed witness line on NAVPERS 1626/7 - - - - - Yes ___ No ___
10. Accused waived his or her rights - - - - - Yes ___ No ___
11. Accused made statement (only when #10 is Yes), and
- a. The accused's signed statement is attached.
- b. The summary of investigation is attached.

Figure 6-2.—Sample preliminary inquiry officer's report.

get the signature and title of the person who is imposing the restraint.

Section D of figure 6-1 shows information about the accused. Get the accused's service record before filling this section out in order to verify all the information. In the section Record of Previous Offense(s), list all NJPs and courts-martial during the accused's current enlistment.

PRE-MAST SCREENING

LEARNING OBJECTIVES: Explain the preliminary inquiry. Identify the preheating advice and the forms used to document NJP screening. Describe the executive officer's screening process.

After you have completed the front of the NAVPERS 1626/7, the case must touch two more bases before it is ready for hearing by the CO. The first step is to refer the report chit to an officer or senior enlisted person for a preliminary inquiry that will later be screened by the XO.

PRELIMINARY INQUIRY

At small commands cases are referred to division officers for the preliminary inquiry. At large commands the discipline officer or legal officer is delegated the authority to appoint the preliminary inquiry officer (PIO). You need to fill in the name of the PIO at the top of section E on figure 6-1 before referring it to the PIO for action.

It is not the job of the PIO to develop a case against the accused. Rather, the PIO is to collect all available facts about the offense itself and about the background of the accused. You should have a standard form that the PIO prepares for submission to the CO. Figure 6-2 is a good example of what should be included in a PIO's report.

When the accused wishes to waive his or her rights on self-incrimination and to make a statement, Suspect's Rights Acknowledgement/Statement (fig. 6-3) should be used. However, figure 6-3 is a suggested format and its use is not mandatory. You should provide the PIO with this form in case the accused desires to make a statement.

Now let's go back and look at the report chit. In addition to filling out a PIO's report the PIO completes

section E of the report chit (fig. 6-1) by doing the following:

- Inserting a short resume of the division officer's opinion of the accused
- Listing the names of the witnesses whose presence at mast is necessary to dispose of the case
- Recommending a disposition of the case
- Summarizing the evidence that supports the recommendation

The recommendation of the PIO is not binding on the CO.

After the PIO has completed his or her inquiry, the report chit, preliminary inquiry report, and all statements are sent to the CO for a determination of whether disposition by nonjudicial punishment is appropriate.

PREHEARING ADVICE

If, after the preliminary inquiry, the CO determines that disposition by nonjudicial punishment is appropriate, the CO causes the accused to be given the advice outlined in part V, par. 4, MCM, 1984. The CO need not give the advice personally but may assign this responsibility to the legal officer, discipline officer, or another appropriate person. The advice that must be given includes the following:

- Contemplated action. This informs the accused that the CO is considering the imposition of nonjudicial punishment for the offense(s).
- Suspected offense(s). This describes the suspected offense(s) to the accused. The description should include the specific article(s) of the UCMJ that the accused is alleged to have violated.
- Government evidence. This advises the accused of the information that the allegations are based on. It also informs the accused that, upon request, he or she is allowed to examine all available statements and evidence.
- Right to refuse NJP. Unless the accused is attached to or embarked in a vessel (in which case he or she has no right to refuse NJP), this informs the accused of his or her right to demand trial by court-martial instead of nonjudicial punishment. The accused must also be informed of (1) the maximum punishment that can be awarded at nonjudicial punishment; (2) that if he or she demands trial by court-martial, referral of the

charges to trial by SCM, special court-martial (SPCM), or GCM is possible; (3) that he or she cannot be tried by SCM over his or her objection; and (4) at an SPCM or a GCM the accused has the right to representation by counsel.

● Right to confer with independent counsel. Because an accused who is not attached to or embarked in a vessel has the right to refuse NJP, this informs the accused of his or her right to confer with independent counsel about his or her decision to accept or refuse

SUSPECT'S RIGHTS ACKNOWLEDGEMENT/STATEMENT (See JAGMAN 0170)			
FULL NAME (ACCUSED/ SUSPECT)	SSN	RATE/RANK	SERVICE (BRANCH)
ACTIVITY/UNIT			DATE OF BIRTH
NAME (INTERVIEWER)	SSN	RATE/RANK	SERVICE (BRANCH)
ORGANIZATION		BILLET	
LOCATION OF INTERVIEW		TIME	DATE

RIGHTS

I certify and acknowledge by my signature and initials set forth below that, before the interviewer requested a statement from me, he/she warned me that:

(1) I am suspected of having committed the following offense(s);

[]

(2) I have the right to remain silent - - - - -

[]

(3) Any statement I do make may be used as evidence against me in trial by court-martial; - - - - -

[]

(4) I have the right to consult with lawyer counsel prior to any questioning. This lawyer counsel may be a civilian lawyer retained by me at my own expense, a military lawyer appointed to act as my counsel without cost to me, or both; and

[]

(5) I have the right to have such retained civilian lawyer and/or appointed military lawyer present during this interview, - - - - -

[]

Figure 6-3.—Suspect's rights acknowledgement/statement.

the NJP. This advice must be given to make sure the record of that NJP is admissible in evidence against the accused should he or she ever be tried by court-martial. A failure to advise an accused properly of his or her right to confer with counsel, or a failure to

provide counsel, will not, however, render the imposition of nonjudicial punishment invalid or make a ground for appeal. Therefore, if the command imposing the NJP desires that the record of the NJP be admissible for court-martial purposes, you must

WAIVER OF RIGHTS

I further certify and acknowledge that I have read the above statement of my rights and fully understand them, and that, -----

(1) I expressly desire to waive my right to remain silent; -----

(2) I expressly desire to make a statement; -----

(3) I expressly do not desire to consult with either a civilian lawyer retained by me or a military lawyer appointed as my counsel without cost to me prior to questioning; -----

(4) I expressly do not desire to have such a lawyer present with me during this interview; and -----

(5) This acknowledgement and waiver of rights is made freely and voluntarily by me, and without any promises or threats having been made to me or pressure or coercion of any kind having been used against me. -----

SIGNATURE (ACCUSED/SUSPECT)	TIME	DATE
SIGNATURE (INTERVIEWER)	TIME	DATE
SIGNATURE (WITNESS)	TIME	DATE

The statement which appears on this page (and the following ___ page(s), all of which are signed by me), is made freely and voluntarily by me, and without any promises or threats having been made to me or pressure or coercion of any kind having been used against me.

SIGNATURE (ACCUSED/SUSPECT)

Figure 6-3.—Suspect's rights acknowledgement/statement—Continued.

prepare the record of the NJP according to applicable service regulations and reflect the following:

The accused was advised of his or her right to confer with counsel.

The accused either exercised his or her right to confer with counsel or made a knowing, intelligent, and voluntary waiver of this right.

The accused knowingly, intelligently, and voluntarily waived his or her right to refuse NJP. All such waivers must be in writing.

● **Hearing rights.** The accused is entitled to appear personally before the CO for the nonjudicial punishment hearing if he or she did not demand trial by court-martial or if the right to demand trial by court-martial is not applicable. At such a hearing the accused is entitled to the following:

Be informed of he or her rights under Article 31, UCMJ.

Be accompanied by a spokesperson provided by, or arranged for, the member. (The proceedings should not be unduly delayed to permit the presence of the spokesperson, nor is the spokesperson entitled to travel or similar expenses).

Be informed of the evidence against them relating to the offense.

Be allowed to examine all evidence that the CO will rely on in deciding whether and how much nonjudicial punishment to impose.

Present matters in defense, extenuation, and mitigation, orally, in writing, or both.

Have witnesses present. These witnesses can include those adverse to the accused, upon request, if (a) their statements will be relevant, (b) they are reasonably available, (c) their appearance will not require reimbursement by the government, (d) their appearance will not unduly delay the proceedings or, in the case of a military witness, (e) will not necessitate their being excused from other important duties.

Have the proceedings open to the public unless the CO determines that the proceedings should be closed.

FORMS

The status of the accused determines the form that you must use to record that the accused was informed of his or her prehearing rights.

Figures 6-4, 6-5, and 6-6, Accused's Notification and Election of Rights, also illustrated in appendixes A-1-b, A-1-c, and A-1-d of the *JAG Manual*, comply with the previous requirements of prehearing advice to the accused.

Use appendix A-1-b, figure 6-4, when the accused is attached to or embarked in a vessel.

Use appendix A-1-c, figure 6-5, when an accused is not attached to or embarked in a vessel, and the command does not afford the accused the right to consult with a lawyer to assist the accused in deciding whether to accept or reject NJP. In this case the record of nonjudicial punishment will not be admissible for any purpose at any later court-martial.

Use appendix A-1-d, figure 6-6, when an accused is not attached and to or embarked in a vessel, and the command affords the accused the right to consult with a lawyer before deciding whether to accept or reject nonjudicial punishment.

Use and retention of the proper form are essential. Whatever form you use, attach it to the NAVPERS 1626/7 and retained it in the command's UPB.

In the event punishment is imposed at captain's mast, and appendix A-1-d, figure 6-6, is used, or the accused is represented by a lawyer at the hearing, you will need to document the Booker rights advice on a page 13 of the member's service record book. This is necessary because appendix A-1-d, figure 6-6, stays in the command UPB. If the member transfers out of the area and is later charged with offenses that are referred to a court-martial, the trial counsel can prove Booker rights advice was given with the page 13. As an example, the page 13 should state the following:

(Grade and name of accused) signed *JAG Manual* appendix A-1-d, before to his or her captain's mast which was held on (date of captain's mast). The accused [talked to a lawyer before deciding whether to demand trial by court-martial instead of captain's mast] [gave up his or her right to talk to a lawyer before to deciding whether to demand trial by court-martial instead of captain's mast]. The accused was advised that acceptance of nonjudicial punishment does not prevent

(CAPTAIN'S MAST) (OFFICE HOURS)
ACCUSED'S NOTIFICATION AND ELECTION OF RIGHTS
ACCUSED ATTACHED TO OR EMBARKED IN A VESSEL
(See JAGMAN 0109)

Notification and election of rights concerning the contemplated imposition of nonjudicial punishment in the case of _____, SSN _____, assigned or attached to _____.

NOTIFICATION

1. In accordance with the requirements of paragraph 4 of Part V, MCM, 1984, you are hereby notified that the commanding officer is considering imposing nonjudicial punishment on you because of the following alleged offenses:

(Note: Here describe the offenses, including the UCMJ article(s) allegedly violated.)

2. The allegations against you are based on the following information:

(Note: Here provide a brief summary of that information.)

3. You may request a personal appearance before the commanding officer or you may waive this right.

a. Personal appearance waived. If you waive your right to appear personally before the commanding officer, you will have the right to submit any written matters you desire for the commanding officer's consideration in determining whether or not you committed the offenses alleged, and, if so, in determining an appropriate punishment. You are hereby informed that you have the right to remain silent and that anything you do submit for consideration may be used against you in a trial by court-martial.

b. Personal appearance requested. If you exercise your right to appear personally before the commanding officer, you shall be entitled to the following rights at the proceeding:

(1) To be informed of your rights under Article 31(b), UCMJ;

(2) To be informed of the information against you relating to the offenses alleged;

(3) To be accompanied by a spokesperson provided or arranged for by you. A spokesperson is not entitled to travel or similar expenses, and the proceedings will not be delayed to permit the presence of a spokesperson. The spokesperson may speak on your behalf, but may not question witnesses except as the commanding officer may permit as a matter of discretion. The spokesperson need not be a lawyer;

(4) To be permitted to examine documents or physical objects against you that the commanding officer has examined in the case and on which the commanding officer intends to rely in deciding whether and how much nonjudicial punishment to impose;

(5) To present matters in defense, extenuation, and mitigation orally, in writing, or both;

Figure 6-4.—Accused's notification and election of rights - accused attached to or embarked in a vessel.

(6) To have witnesses attend the proceeding, including those that may be against you, if their statements will be relevant and they are reasonably available. A witness is not reasonably available if the witness requires reimbursement by the United States for any cost incurred in appearing, cannot appear without unduly delaying the proceedings, or if a military witness, cannot be excused from other important duties; and

(7) To have the proceedings open to the public unless the commanding officer determines that the proceedings should be closed for good cause. However, this does not require that special arrangements be made to facilitate access to the proceedings.

ELECTION OF RIGHTS

4. Knowing and understanding all of my rights as set forth in paragraphs 1 through 3 above, my desires are as follows:

a. Personal appearance. (Check one)

_____ I request a personal appearance before the commanding officer.

_____ I waive a personal appearance. (Check one)

_____ I do not desire to submit any written matters for consideration.

_____ Written matters are attached.

(Note: The accused's waiver of personal appearance does not preclude the commanding officer from notifying the accused, in person, of the punishment imposed.)

b. Election at personal appearance. (Check one or more)

_____ I request that the following witnesses be present at my nonjudicial punishment proceeding:

_____ I request that my nonjudicial punishment proceeding be open to the public.

(Signature of witness)

(Signature of accused)

(Name of witness)

(Name of accused)

Figure 6-4.—Accused's notification and election of rights - accused attached to or embarked in a vessel—Continued.

(CAPTAIN'S MAST) (OFFICE HOURS)
ACCUSED'S NOTIFICATION AND ELECTION OF RIGHTS
ACCUSED NOT ATTACHED TO OR EMBARKED IN A VESSEL
RECORD CANNOT BE USED IN AGGRAVATION IN EVENT OF LATER
COURT-MARTIAL UNLESS LAWYER SERVES AS PERSONAL REPRESENTATIVE
(See JAGMAN 0109)

Notification and election of rights concerning the contemplated imposition of nonjudicial punishment in the case of _____, SSN _____, assigned or attached to _____.

NOTIFICATION

1. In accordance with the requirements of paragraph 4 of Part V, MCM, 1984, you are hereby notified that the commanding officer is considering imposing nonjudicial punishment on you because of the following alleged offenses:

(Note: Here describe the offenses, including the UCMJ article(s) allegedly violated.)

2. The allegations against you are based on the following information:

(Note: Here provide a brief summary of that information.)

3. You have the right to refuse imposition of nonjudicial punishment. If you refuse nonjudicial punishment, charges could be referred for trial by court-martial by summary, special, or general court-martial. If charges are referred to trial by summary court-martial, you may not be tried by summary court-martial over your objection. If charges are referred to a special or general court-martial, you will have the right to be represented by counsel. The maximum punishment that could be imposed if you accept nonjudicial punishment is:

4. If you decide to accept nonjudicial punishment, you may request a personal appearance before the commanding officer or you may waive this right.

a. Personal appearance waived. If you waive your right to appear personally before the commanding officer, you will have the right to submit any written matters you desire for the commanding officer's consideration in determining whether or not you committed the offenses alleged, and, if so, in determining an appropriate punishment. You are hereby informed that you have the right to remain silent and that anything you do submit for consideration may be used against you in a trial by court-martial.

b. Personal appearance requested. If you exercise your right to appear personally before the commanding officer, you shall be entitled to the following rights at the proceeding:

(1) To be informed of your rights under Article 31(b), UCMJ;

(2) To be informed of the information against you relating to the offenses alleged;

(3) To be accompanied by a spokesperson provided or arranged for by you. A spokesperson is not entitled to travel or similar expenses, and the proceedings will not be delayed to permit the presence of a spokesperson. The spokesperson may speak on your behalf, but may not question witnesses except as the commanding officer may permit as a matter of discretion. The spokesperson need not be a lawyer;

(4) To be permitted to examine documents or physical objects against you that the commanding officer has examined in the case and on which the commanding officer intends to rely in deciding whether and how much nonjudicial punishment to impose;

Figure 6-5.—Accused's notification and election of rights - accused NOT attached to or embarked in a vessel. Record CANNOT be used in aggravation in event of later court-martial unless lawyer served as personal representative.

(5) To present matters in defense, extenuation, and mitigation orally, in writing, or both;

(6) To have witnesses attend the proceeding, including those that may be against you, if their statements will be relevant and they are reasonably available. A witness is not reasonably available if the witness requires reimbursement by the United States for any cost incurred in appearing, cannot appear without unduly delaying the proceedings, or if a military witness, cannot be excused from other important duties; and

(7) To have the proceedings open to the public unless the commanding officer determines that the proceedings should be closed for good cause. However, this does not require that special arrangements be made to facilitate access to the proceedings.

ELECTION OF RIGHTS

5. Knowing and understanding all of my rights as set forth in paragraphs 1 through 4 above, my desires are as follows:

a. Right to refuse nonjudicial punishment. (Check one)

_____ I refuse nonjudicial punishment

_____ I accept nonjudicial punishment

(Note: If the accused does not accept nonjudicial punishment, the matter should be submitted to the commanding officer for disposition.)

b. Personal appearance. (Check one)

_____ I request a personal appearance before the commanding officer.

_____ I waive a personal appearance. (Check one)

_____ I do not desire to submit any written matters for consideration.

_____ Written matters are attached.

(Note: The accused's waiver of personal appearance does not preclude the commanding officer from notifying the accused, in person, of the punishment imposed.)

c. Election at personal appearance. (Check one or more)

_____ I request that the following witnesses be present at my nonjudicial punishment proceeding:

_____ I request that my nonjudicial punishment proceeding be open to the public.

(Signature of witness)

(Signature of accused)

(Name of witness)

(Name of accused)

Figure 6-5.—Accused's notification and election of rights - accused NOT attached to or embarked in a vessel. Record CANNOT be used in aggravation in event of later court-martial unless lawyer served as personal representative—Continued.

(CAPTAIN'S MAST) (OFFICE HOURS)
ACCUSED'S NOTIFICATION AND ELECTION OF RIGHTS
ACCUSED NOT ATTACHED TO OR EMBARKED IN A VESSEL
RECORD MAY BE USED IN AGGRAVATION IN EVENT OF LATER COURT-MARTIAL
(See JAGMAN 0109)

Notification and election of rights concerning the contemplated imposition of nonjudicial punishment in the case of _____, SSN _____, assigned or attached to _____.

NOTIFICATION

1. In accordance with the requirements of paragraph 4 of Part V, MCM, 1984, you are hereby notified that the commanding officer is considering imposing nonjudicial punishment on you because of the following alleged offenses:

(Note: Here describe the offenses, including the UCMJ article(s) allegedly violated.)

2. The allegations against you are based on the following information:

(Note: Here provide a brief summary of that information.)

3. You have the right to refuse imposition of nonjudicial punishment. If you refuse nonjudicial punishment, charges could be referred for trial by court-martial by summary, special, or general court-martial. If charges are referred to trial by summary court-martial, you may not be tried by summary court-martial over your objection. If charges are referred to a special or general court-martial, you will have the right to be represented by counsel. The maximum punishment that could be imposed if you accept nonjudicial punishment is:

4. If you decide to accept nonjudicial punishment, you may request a personal appearance before the commanding officer or you may waive this right.

a. Personal appearance waived. If you waive your right to appear personally before the commanding officer, you will have the right to submit any written matters you desire for the commanding officer's consideration in determining whether or not you committed the offenses alleged, and, if so, in determining an appropriate punishment. You are hereby informed that you have the right to remain silent and that anything you do submit for consideration may be used against you in a trial by court-martial.

b. Personal appearance requested. If you exercise your right to appear personally before the commanding officer, you shall be entitled to the following rights at the proceeding:

(1) To be informed of your rights under Article 31(b), UCMJ;

(2) To be informed of the information against you relating to the offenses alleged;

(3) To be accompanied by a spokesperson provided or arranged for by you. A spokesperson is not entitled to travel or similar expenses, and the proceedings will not be delayed to permit

Figure 6-6.—Accused's notification and election of rights - accused NOT attached to or embarked in a vessel. Record MAY be used in aggravation in event of later court-martial.

the presence of a spokesperson. The spokesperson may speak on your behalf, but may not question witnesses except as the commanding officer may permit as a matter of discretion. The spokesperson need not be a lawyer;

(4) To be permitted to examine documents or physical objects against you that the commanding officer has examined in the case and on which the commanding officer intends to rely in deciding whether and how much nonjudicial punishment to impose;

(5) To present matters in defense, extenuation, and mitigation orally, in writing, or both;

(6) To have witnesses attend the proceeding, including those that may be against you, if their statements will be relevant and they are reasonably available. A witness is not reasonably available if the witness requires reimbursement by the United States for any cost incurred in appearing, cannot appear without unduly delaying the proceedings, or if a military witness, cannot be excused from other important duties; and

(7) To have the proceedings open to the public unless the commanding officer determines that the proceedings should be closed for good cause. However, this does not require that special arrangements be made to facilitate access to the proceedings.

5. In order to help you decide whether or not to demand trial by court-martial or to exercise any of the rights explained above should you decide to accept nonjudicial punishment, you may obtain the advice of a lawyer prior to any decision. If you wish to talk to a lawyer, a military lawyer will be made available to you, either in person or by telephone, free of charge, or you may obtain advice from a civilian lawyer at your own expense.

ELECTION OF RIGHTS

6. Knowing and understanding all of my rights as set forth in paragraphs 1 through 5 above, my desires are as follows:

a. Lawyer: (Check one or more, as applicable)

_____ I wish to talk to a military lawyer before completing the remainder of this form.

_____ I wish to talk to a civilian lawyer before completing the remainder of this form.

_____ I hereby voluntarily, knowingly, and intelligently give up my right to talk to a lawyer.

(Signature of witness)

(Signature of accused/date)

Figure 6-6.—Accused's notification and election of rights - accused NOT attached to or embarked in a vessel. Record MAY be used in aggravation in event of later court-martial—Continued.

(Note: If the accused wished to talk to a lawyer, the remainder of this form shall not be completed until the accused has been given a reasonable opportunity to do so.)

_____ I talked to _____, a lawyer, on _____.

(Signature of witness)

(Signature of accused/date)

b. Right to refuse nonjudicial punishment. (Check one)

_____ I refuse nonjudicial punishment

_____ I accept nonjudicial punishment

(Note: If the accused does not accept nonjudicial punishment, the matter should be submitted to the commanding officer for disposition.)

c. Personal appearance. (Check one)

_____ I request a personal appearance before the commanding officer.

_____ I waive a personal appearance. (Check one)

_____ I do not desire to submit any written matters for consideration

_____ Written matters are attached.

(Note The accused's waiver of personal appearance does not preclude the commanding officer from notifying the accused, in person, of the punishment imposed.)

d. Election at personal appearance. (Check one or more)

_____ I request that the following witnesses be present at my nonjudicial punishment proceeding:

_____ I request that my nonjudicial punishment proceeding be open to the public.

(Signature of witness)

(Signature of accused)

(Name of witness)

(Name of accused)

Figure 6-6.—Accused's notification and election of rights - accused NOT attached to or embarked in a vessel. Record MAY be used in aggravation in event of later court-martial—Continued.

further administrative action. In completing the remainder of the form, the accused did not demand trial by court-martial instead of captain's mast.

If the accused is represented by a military or civilian lawyer as a personal representative at his or her captain's mast, the following example should be made on a page 13:

(Grade and name of accused) received punishment at captain's mast on (date). The accused was represented by a lawyer.

If the member refuses to sign the forms, simply record that you advised him or her of his or her rights but the member declined to sign the forms. Note that the member must demand trial by court-martial and if he or she fails to make such a demand, the command may proceed with nonjudicial punishment. Once all preheating advice is given, the accused is ready for XO's screening.

EXECUTIVE OFFICER'S (XO'S) SCREENING

The XO may screen a case by holding an informal hearing or may merely review the record of the accused and the report chit. If the XO has been given the power by the CO, he or she may dismiss the case, but may NEVER impose punishment.

At XO's screening mast the accused is advised again of the right to refuse NJP and demand a trial by court-martial. At this point section G of figure 6-1 can be signed by the accused if it was not signed before. Be sure to get the witness' signature in this section also.

Remember Article 15, UCMJ, does not give the right to refuse NJP to persons attached to vessels. Also remember that an accused not attached to or embarked in a vessel may elect at any time before imposition of NJP to refuse it and demand a court-martial. It is possible for an accused to elect not to demand trial by court-martial at XO's screening but later at captain's mast demand it provided it is before punishment is imposed.

Once the XO has conducted an inquiry, he or she has the option of referring the case to mast or dismissing it. The XO fills in section F of figure 6-1 annotating the action he or she has taken. If the case is referred to the CO for mast, a formal hearing is set up. Note that sections H, I, and J of figure 6-1 is for

the action of the CO, the accused's right of appeal, and the final administrative action, respectively.

THE NJP HEARING PROCEDURE

LEARNING OBJECTIVES: Describe the requirements for NJP hearing procedure. Explain some of the possible actions by the CO at mast.

The CO decides when and where a captain's mast will be held. The XO, legal officer, or discipline officer normally assists the CO. As an MA, you will be present to keep order and call the accused to mast. You will also provide any additional documents needed by the CO.

While local practices will come into play as far as setting up the mast and the formalities required, figure 6-7, appendix A-1-e of the *JAG Manual* is the official guide for the nonjudicial punishment proceedings.

HEARING REQUIREMENTS

Except as noted below, nonjudicial punishment cases must be handled at a hearing at which the accused is allowed to exercise the foregoing rights. In addition, there are other technical requirements about the hearing and the exercise of the accused's rights.

Personal Appearance Waived

An accused may waive his or her right to appear personally before the CO, and may submit a written explanation for consideration by the CO before NJP is imposed. If the accused makes this election, make sure the accused is informed of the right to remain silent and that any matters submitted may be used at trial by court-martial.

Notwithstanding the accused's expressed desire to waive his or her right to appear personally at the nonjudicial punishment hearing, the accused may be ordered to attend the hearing if the officer imposing nonjudicial punishment desires his or her presence. If the accused waives his or her personal appearance and NJP is imposed, the CO must make sure the accused is informed of the punishment as soon as possible. For more information on this topic see part V, par. 4c(2), MCM, 1984.

CAPTAIN'S MAST GUIDE

(NOTE: The formalities prior to and at the termination of the captain's mast normally are determined by customs and tradition of the Navy.)

CO: You are suspected of committing the following violation(s) of the Uniform Code of Military Justice:

You do not have to make any statement regarding the offense(s) of which you are accused or suspected and any statement made by you may be used as evidence against you.

(Note: If it is reasonably foreseeable that the accused's statements during the captain's mast proceedings may be considered for introduction in evidence at a later court-martial, an explanation of rights and a waiver, in the format of appendix A-1-m of the JAG Manual, will have to be obtained from the accused, during the hearing, before proceeding further.)

CO: You are advised that a captain's mast is not a trial and that a determination of misconduct on your part is not a conviction by a court. Further, you are advised that the formal rules of evidence used in trials by court-martial do not apply at captain's mast.

CO: I have a statement signed by you acknowledging that you were fully advised of your legal rights pertaining at this hearing. **(Note:** This statement will be either JAGMAN, appendix A-1-b, A-1-c, or A-1-d.)

CO: Do you understand this statement and do you understand the rights explained therein?

ACC: _____

CO: Do you have any questions about them or do you wish to make any requests?

ACC: _____

CO: [To witness (if any are present)] What can you tell me about the accused's involvement in (these) (this) offense(s)?

WIT: _____

CO: [To witness who has/have previously provided written statement(s) when accused and CO both have copies of the state merit(s).] Do you adopt your statement(s) as your testimony here today?

ACC: _____

Figure 6-7.—Captain's mast guide.

CO: Do you have anything to add to or change in your statement?

WIT: _____

CO: (To accused) Would you like me to ask any further questions of this witness?

ACC: _____

CO: (After all witnesses are questioned) I have before me the following (documents) (statements) (other physical evidence) that will be considered by me. Have you been given the opportunity to examine them?

ACC: _____

CO: (If there is a "no," offer the accused the opportunity to examine the evidence.)

CO: Is there anything that you wish to offer? (If the answer is "yes," permit the accused the opportunity to call his or her witnesses, make a personal statement in defense, and present other evidence.)

ACC: _____

CO: Are there any other witnesses you would like to call or any other evidence you would like to present?

ACC: _____

CO: (To witness) What can you tell me about (accused's name) performance of duty?

WIT: _____

CO: (To accused) Is there anything else you would like to present?

ACC: _____

CO: I impose the following punishment:

My decision to impose this punishment was based on my determination that you committed the minor offenses of

You are advised that you have the right to appeal this punishment to (identify the superior authority by name and organizational title). You appeal must be made within a reasonable time—which is normally 5 days. Following this hearing _____ will advise you more fully of this right to appeal. Do you understand?

ACC: _____

CO: You are dismissed.

Figure 6-7.—Captain's mast guide—Continued.

Hearing Officer

Normally, the officer who actually holds the nonjudicial punishment hearing is the CO of the accused. COs or OICs are allowed to delegate their authority to hold the hearing to another officer under extraordinary circumstances. These circumstances must be unusual and significant rather than matters of convenience to the commander. This delegation of authority should be in writing and detailed reasons given. This delegation, however, does not include the authority to impose punishment. At such a hearing, the officer delegated to hold the hearing will receive all evidence, prepare a summarized record of matters considered, and send the record to the officer having nonjudicial punishment authority.

Burden of Proof

The CO must decide that the accused is “guilty” by a preponderance of the evidence. *Black’s Law Dictionary* defines preponderance of evidence as “evidence which is of greater weight or more convincing than the evidence which is offered in opposition to it. . .”

Personal Representative

The accused is responsible for getting a person to represent him or her at NJP. As a practical matter, the accused is free to choose anyone—a lawyer or nonlawyer, an officer or an enlisted person. The freedom of the accused to choose a representative does not compel the command to provide lawyer counsel, and current regulations do not create a right to counsel at NJP, whereas such a right does exist at a court-martial.

Representation by any lawyer who is willing and able to appear at the hearing on behalf of the accused is authorized. While a lawyer’s workload may prevent the lawyer from appearing, a blanket rule that no lawyers can appear at Article 15 hearings would appear to contravene the spirit if not the letter of the law. It is likewise doubtful that a lawyer can lawfully be ordered to represent the accused. It is fair to say that the accused can have anyone who is able and willing to appear without cost to the government. While a command does not have to provide a personal representative, it should help the accused get the representative he or she wants. In this connection, if the accused desires a personal representative, allow him or her a reasonable time to get someone. Use good

judgment here, for such a period should be neither too short nor too long.

Witnesses

When the hearing involves controverted questions of fact about the alleged offenses, witnesses should be available to testify if they are present on the same ship or base or are otherwise available at no expense to the government. Thus, in a larceny case, if the accused denies wrongdoing, the witnesses who can testify that an offense was committed should be called to testify in person if they are available at no cost to the government. It should be noted, however, that no authority exists to subpoena civilian witnesses for an NJP proceeding.

Public Hearing

The accused is entitled to have the hearing open to the public unless the CO determines that the proceeding should be closed for good cause. The CO is not required to make any special arrangements to facilitate public access to the proceedings.

Publication of NJP Results

Authority to publish the results of nonjudicial punishment is granted by section 0115 of the *JAG Manual*. You may publish the name, rate, offense(s), and disposition of the offender in the plan of the day (POD). Publish the results not later than 1 month after the imposition of nonjudicial punishment. If the NJP is appealed, publish the results not later than 1 month after the date the appeal is denied. If the POD is distributed to military personnel only, you may include all the details stated previously. If the POD is distributed to other than military personnel, nonjudicial punishment results may be published without the name of the accused.

POSSIBLE ACTIONS BY THE CO AT MAST

Dismissal with or without warning. This action is taken if the CO is not convinced by the evidence that the accused is guilty of an offense, or decides that no punishment is appropriate in light of the accused’s record and other circumstances. Dismissal, whether with or without a warning, is not considered NJP, nor is it considered an acquittal.

Referral to an SCM, SPCM, or a pretrial investigation under Article 32, UCMJ. The CO may in his or her sole discretion, refer the charge(s) to either

an SCM, an SPCM or an Article 32 investigation. This will of course, depend upon the severity of the charges.

Postponement of action. The CO may postpone any action on the nonjudicial punishment pending further investigation or for other good cause, such as a pending trial by civil authorities for the same offense.

Imposition of NJP. The CO may impose nonjudicial punishment and award any of the authorized punishments outlined in part V, par. 5, MCM.

AUTHORIZED PUNISHMENTS

LEARNING OBJECTIVES: Describe the limitations, the nature, and the execution of NJP punishments. Differentiate between authorized and unauthorized combinations of NJP punishments.

If the CO is convinced by the evidence that the accused is guilty of the offense(s) and he or she deems punishment is proper, the CO has wide latitude to impose punishment. There are, however, limitations that are placed on the CO based upon his or her rank and the status of the accused.

LIMITATIONS

The maximum punishment that can be awarded in any Article 15, UCMJ, case is limited by several factors that include the following:

- The grade of the imposing officer. COs in grades O-4 to O-6 have greater punishment powers than officers in grades O-1 to O-3. Flag officers, general officers, and officers exercising general court-martial jurisdiction have greater punishment authority than COs in grades O-4 to O-6.
- The status of the imposing officer. Regardless of the rank of an OIC, his or her punishment power is limited to that of COs in grades O-1 to O-3. The punishment powers of a CO are commensurate with his or her permanent grade.
- The status of the accused. Punishment authority is also limited by the status of the accused. Is the accused an officer or an enlisted person attached to or embarked in a vessel?

Maximum punishment limitations apply to each NJP action and not to each offense. Note that there is

a policy that all known offenses that the accused is suspected of should ordinarily be considered at a single Article 15 hearing. Table 6-1 summarizes the maximum punishment limitations for nonjudicial punishment.

NATURE OF THE PUNISHMENT

There are eight specific types of punishment that may, under proper circumstances, be imposed as nonjudicial punishment. Remember, there are limitations based upon the COs rank and the status of the offender. Refer to table 6-1 as you read the following discussion of individual punishments.

Admonition and Reprimand

Admonition and reprimand are two forms of censure intended to express adverse reflection upon or criticism of a person's conduct. A reprimand is a more severe form of censure than an admonition. When imposed as nonjudicial punishment, the admonition or reprimand is considered to be punitive, unlike the nonpunitive admonition and reprimand. Punitive censure for officers must be in writing, although it may be either oral or written for enlisted personnel. Procedures for issuing punitive letters are detailed in section 0114 of the *JAG Manual*. A sample punitive letter of reprimand is shown in appendixes A-1-g of the *JAG Manual*.

Arrest in Quarters

This punishment is for officers only. It is a moral restraint, as opposed to a physical restraint. It is similar to restriction, but has much narrower limits. The limits of arrest are set by the officer imposing the punishment and may extend beyond quarters. The term *quarters* includes military and private residences. The officer may be required to perform regular duties as long as the duties do not involve the exercise of authority over subordinates.

Restriction

Restriction is the least severe form of liberty deprivation. Restriction involves moral rather than physical restraint. The severity of this type of restraint depends on its duration and the geographical limits specified when the punishment is imposed. A person undergoing restriction may be required to report to a designated place at specified times if reasonably

necessary to make sure the punishment is being properly executed.

Restriction ashore means that an accused will be restricted to the limits of the command except, of course, at larger shore stations where the use of recreational facilities might be further governed. Restriction and arrest in quarters are normally imposed by a written order detailing the limits thereof and usually require the accused to log in at certain specified times during the restraint. Article 1103 of *U.S. Navy Regulations, 1990*, provides that an officer placed in the status of arrest or restriction will not be confined to quarters unless the safety or the discipline of the ship requires such action.

Forfeiture

Forfeiture means a permanent lost of pay. A forfeiture applies to basic pay and to sea or foreign duty pay, but not to incentive pay or allowances for subsistence or quarters. The amount of forfeiture of

pay is expressed in whole dollar amounts, not in fractions, and shows the number of months affected. An example of a properly stated forfeiture is "to forfeit \$50 pay per month for 2 months."

If the punishment includes both reduction, whether or not suspended, and forfeiture of pay, the forfeiture must be based on the grade to which the accused is reduced. Forfeitures are effective on the date imposed unless suspended or deferred. Where a previous forfeiture is being executed, that forfeiture will be completed before any newly imposed forfeiture is executed.

Extra Duty

Extra duties involve duties in addition to those normally assigned. Various types of duties may be awarded, including fatigue duties. The MCM prohibits extra duties that are a known safety or health hazard, those that are cruel and unusual, or those that are not sanctioned by naval custom.

Table 6-1.—Limits of Punishments Under UCMJ, Article 15

		PUNISHMENT							
IMPOSED BY	IMPOSED ON	CONFINEMENT ON B&W OR DIM RATS ¹	CORRECTIONAL CUSTODY ²	ARREST IN QUARTERS ³	FORFEITURE ^{4,5}	REDUCTION ^{4,6}	EXTRA DUTIES ⁷	RESTRICTION TO LIMITS ⁷	ADMONITION OR REPRIMAND ⁴
GENERAL OFFICERS IN COMMAND	OFFICERS	NO	NO	30 days	1/2 of 1 month for 2 months	NO	NO	60 days	YES
	E-4 TO E-9	NO	NO	NO	1/2 of 1 month for 2 months	1 grade	45 days	60 days	YES
	E-1 TO E-3	3 days	30 days	NO	1/2 of 1 month for 2 months	1 grade	45 days	60 days	YES
O-4 to O-6	OFFICERS	NO	NO	NO	NO	NO	NO	30 days	YES
	E-4 TO E-9	NO	NO	NO	1/2 of 1 month for 2 months	1 grade	45 days	60 days	YES
	E-1 TO E-3	3 days	30 days	NO	1/2 of 1 month	1 grade	45 days	60 days	YES
O-3 below and OICs ⁸	OFFICERS	NO	NO	NO	NO	NO	NO	15 days	YES
	E-4 TO E-9	NO	NO	NO	7 days	1 grade	14 days	14 days	YES
	E-1 TO E-3	3 days	7 days	NO	7 days	1 grade	14 days	14 days	YES

¹May be awarded only if attached to/embarked in a vessel and may not be combined with any other restraint punishment or extra duties.

²May not be combined with restriction or extra duties.

³May not be combined with restriction.

⁴May be imposed in addition to or in lieu of all other punishments.

⁵Shall be expressed in whole dollar amounts only.

⁶Chief petty officers, paygrades E-7 thru E-9, may not be reduced at NJP in the Navy; while Marine Corps NCOs, paygrades E-6 thru E-9, may not be reduced at NJP.

⁷Restriction and extra duties may be combined to run concurrently but the combination may not exceed the maximum imposable for extra duties.

⁸OICs have NJP authority over enlisted personnel only.

When extra duties are imposed upon a petty officer, the duties cannot be demeaning to his or her rate or position. The immediate CO of the accused normally designates the amount and character of extra duty. Such duties normally should not extend beyond 2 hours per day. Guard duty may not be assigned as extra duty. Extra duty is not performed on Sunday although Sundays count as if such duty was performed.

Reduction in Grade

Reduction in paygrade is limited to one grade only for members in paygrades E-1 through E-6. E-7 through E-9 personnel cannot be reduced in grade at NJP. The grade from which reduced must be within the promotional authority of the CO imposing the reduction. See also NAVMILPERSMAN, Article 3420140.2, for additional information on reduction.

Correctional Custody

Correctional custody is a form of physical restraint of a person during either duty or nonduty hours, or both, and may include hard labor, extra duties, or fatigue duties. Awardees may perform military duty but not watches and cannot bear arms or exercise authority over subordinates. Specific regulations for administering correctional custody can be found in OPNAVINST 1640.7, *Instructions for Administering Correctional Custody*.

Time spent in correctional custody is not lost time. Correctional custody cannot be imposed on paygrades E-4 and above. To assist commanders in imposing correctional custody, correctional custody units (CCUs) have been established at major shore installations. Check the local operating procedures for the nearest CCU before correctional custody is imposed.

Confinement on Bread and Water or Diminished Rations

These punishments can only be awarded to E-3s and below if they are attached to or embarked in a vessel. These punishments involve physical confinement and are equivalent to solitary confinement because contact is allowed only with authorized personnel.

A medical officer must first certify in writing that the accused will suffer no serious injury and that the place of confinement will not harm the accused.

Diminished rations is a restricted diet of 2,100 calories per day, and instructions for its use are detailed in SECNAVINST 1640.9.

EXECUTION OF PUNISHMENTS

All punishments, if not suspended, take effect when imposed. This means that the punishment in most cases will take effect when the CO informs the accused of his or her decision. Thus, if the CO wishes to impose a prospective punishment, one to take effect at a future time, he or she should simply delay the impositions of nonjudicial punishment altogether. There are, however, several specific rules that authorize the deferral or stay of a punishment already imposed.

Deferral of Correctional Custody or Confinement on Bread and Water or Diminished Rations

Section 0113b(3) of the *JAG Manual* permits a CO or an OIC to defer correctional custody, confinement on bread and water, or confinement on diminished rations for up to 15 days when adequate facilities are not available; the exigencies of the service so require; or the accused is not physically fit for the service of the punishments.

Deferral of Restraint Punishments Pending NJP Appeal

A service member who has appealed nonjudicial punishment may be required to undergo any punishment imposed while the appeal is pending. However, if action is not taken on the appeal within 5 days after the appeal was submitted, and if the service member so requests, any unexecuted punishment involving restraint or extra duties is stayed until action on the appeal is taken.

Interruptions of Restraint Punishment by Subsequent NJP

The execution of any nonjudicial punishment involving restraint will normally be interrupted by a later nonjudicial punishment where restraint is awarded. Thereafter, the unexecuted portion of the prior restraint punishment will be executed. The officer imposing the later punishment, however, may order that the prior punishment be completed before the service of the later punishment.

Interruption of Punishment by Unauthorized Absence (UA)

Service of all nonjudicial punishments is interrupted during any period of unauthorized absence (UA). Also, a punishment of reduction may be executed during any period of UA.

COMBINATION OF PUNISHMENTS

When NJP is awarded, certain combinations of punishments are authorized and some combinations are unauthorized. Refer to part V, par. 5d, MCM, 1984, for more information.

Acceptable Combinations

Here are a few examples of acceptable combinations of punishments:

1. If an O-4 CO wishes to impose the maximum amount of all permissible nonjudicial punishments upon an E-3, the maximum that could be imposed would be:

- a. a punitive letter of reprimand or admonition (or an oral reprimand or admonition);
- b. reduction to E-2;
- c. forfeiture of one-half pay per month for 2 months (based upon the reduced rate); and
- d. 45 days' restriction and extra duties to be served concurrently.

2. If an O-3 CO (or any OIC, regardless of grade) wishes to impose the maximum amount of all permissible nonjudicial punishments upon an E-3, the maximum that could be imposed would be:

- a. a punitive letter of reprimand or admonition (or an oral reprimand or admonition);
- b. reduction to E-2;
- c. forfeiture of 7 days' pay (based upon the reduced rate); and
- d. 14 days' restriction and extra duties to be served concurrently.

Unacceptable Combinations

The following combinations of NJP punishments are unacceptable:

- Arrest in quarters may not be imposed in combination with restriction.

- Confinement on bread and water or diminished rations may not be imposed in combination with correctional custody, extra duties, or restriction.
- Correctional custody may not be imposed in combination with restriction or extra duties.
- Restriction and extra duties may be combined to run concurrently, but the combination may not exceed the maximum that can be awarded for extra duties.

CLEMENCY AND CORRECTIVE ACTION ON REVIEW

LEARNING OBJECTIVES: Define clemency and corrective action. Explain who has the authority to take action. Discuss the various forms of clemency and corrective action.

Clemency is a reduction in the severity of punishment and is at the discretion of the officer authorized to take such action. Corrective action is a reduction in the severity of punishment or other action taken by proper authority to correct some defect in the nonjudicial punishment proceeding and to offset the adverse impact of the error on the accused.

AUTHORITY TO ACT

After the imposition of nonjudicial punishment, the following officials have authority to take clemency action or corrective action:

- The officer who initially imposed the NJP (this authority is inherent in the office, not the person holding the office).
- The successor in command to the officer who imposed the punishment.
- The superior authority to whom an appeal from the punishment would be sent, whether or not such an appeal has been made.
- The CO or OIC of a unit, activity, or command that the accused is properly transferred to after the imposition of punishment by the first commander.
- The successor in command of the latter.

For more information on authority to act see part V, par. 6a, MCM, 1984, and section 0118 of the JAG Manual.

FORMS OF ACTION

The forms of action that can be taken, either as clemency or corrective action, consist of setting aside, remission, mitigation, and suspension.

Setting Aside

This power has the effect of voiding the punishment and restoring the rights, privileges, and property lost to the accused by virtue of the punishment imposed. This action should be reserved for compelling circumstances where the commander feels a clear injustice has occurred. This normally means that the commander believes the punishment of the accused was clearly a mistake.

If the punishment has been executed, executive action to set it aside should be taken within a reasonable time—normally within 4 months of its execution. The CO who wishes to reinstate an individual reduced in rate at NJP is not bound by the provisions of MILPERSMAN, Article 2230200, limiting advancement to a rate formerly held only after a minimum of 12 months' observation of performance. Such action can be taken with respect to the whole or a part of the punishment imposed. All entries pertaining to the punishment set aside are removed from the service record of the accused, Refer to MILPERSMAN, Article 5030500.

According to MILPERSMAN, Article 5040110, once a punishment is set aside, the CO prepares and personally signs (no By direction signature is allowed) a letter of notification as shown in figure 6-8. This letter is sent to the Chief of Naval Personnel (PERS-82 for officers) (PERS-83 for enlisted) to make sure all local records are purged of any notation of the NJP and its residual effects. PERS-82 or 83 will notify the CO and the member when the action has been completed.

Remission

This action also relates to the unexecuted portions of punishment; that is, those parts that have not been completed. This action relieves the accused from having to complete his or her punishment, though the accused may have partially completed it. Rights, privileges, and property lost by virtue of executed portions of punishment are not restored, nor is the

punishment voided as in the case when it is set aside. The expiration of the current enlistment or term of service of the service member automatically remits any unexecuted punishment imposed under Article 15.

Mitigation

This action also relates to the unexecuted portions of punishment. Mitigation of punishment is a reduction in the quality or quantity of the punishment imposed. Quality means type of punishment while quantity means how much. In no event may the punishment be increased.

QUALITY.— Without any change in quantity, the following quality reductions may be taken:

- Arrest in quarters to restriction.
- Confinement on bread and water or diminished rations to correctional custody
- Correctional custody or confinement on bread and water or diminished rations to extra duties or restriction or both (to run concurrently)
- Extra duties to restriction

QUANTITY.— The length of deprivation of liberty or the amount of forfeiture or other money punishment also can be reduced and mitigated without any change in the quality (type) of punishment.

REDUCTION IN GRADE.— Reduction in grade, though executed, may be mitigated to forfeiture of pay. The amount of forfeiture can be no greater than that which could have been imposed by the mitigating commander had he or she initially imposed punishment. This type of mitigation must be completed within 4 months after the date of execution.

In mitigating nonjudicial punishment, neither the quality nor the quantity of the punishment may be increased. Therefore, it would not be possible to mitigate 3 days' confinement on bread and water to 4 days' restriction or to mitigate 60 days' restriction to 1 day of confinement on bread and water.

Suspension

Suspension is an action to withhold the execution of punishment for a time pending the good behavior of the accused. Only later misconduct during the probationary period will cause the suspension to be vacated (revoked) and this misconduct must be an offense under the UCMJ. For more information refer to the JAGMAN.

SAMPLE LETTER OF NOTIFICATION

From: (Command setting aside punishment)
To: Chief of Naval Personnel (PERS-82 or 83, as appropriate)
Subj: SET ASIDE OF NJP ICO (GRADE/RATE, NAME, SSN)
Ref: (a) UCMJ

1. I hereby set aside the nonjudicial punishment (NJP) in the case of (grade/rate, name). All rights, privileges, and property affected by virtue of the execution of this punishment shall be restored. In accordance with Article 15(d) of reference (a), request that you remove all reference to the NJP contained in (grade/rate, names) official record. Request that the copy-to addresses take appropriate restorative action in the case of (grade/rate, name) and notify me and the member concerned when completed.

2. The following identifying information is provided:

a. Name: (Grade/Rate, Name, SSN)

b. Date of NJP: (date)

c. Imposing Command: (Indicate using guideline below)

(If different from the command setting aside, indicate by Standard Navy Distribution List [SNDL] long title and forward a copy of the letter of notification to that command.)

(If imposing command is also the command that is setting aside the NJP, indicate by stating "This command.")

d. Reason: (Indicate)

3. This letter shall not be filed in (grade/rate, name) official record, but shall be destroyed after your action is completed.

Signature of Commanding Officer
(By direction not allowed)

copy to:
(command that imposed punishment)
(cognizant personnel office)
(cognizant disbursing office if pay affected)
(member concerned)

Figure 6-8.—Sample letter of notification.

NJP APPEAL

LEARNING OBJECTIVES: Explain the procedure and the time limitations for NJP appeal. Identify and explain the contents of the NJP appeal package,

A member who is awarded NJP and who believes the punishment unjust or disproportionate to the offense has the right to appeal to higher authority.

PROCEDURE

The commanding officer is required to make sure the accused is fully advised of his or her right to appeal. Refer to part V, par. 4c, MCM, 1984, and JAGMAN, sec. 0110e. Figure 6-9 is an accused's acknowledgement of appeal rights that should be signed by the accused and witnessed in order to prove that the accused was informed of appeal rights. File this form with all the other papers in the accused's case file in the UPB.

A person punished under Article 15 may appeal the imposition of such punishment through proper channels to the appropriate appeal authority. If an offender is transferred before filing the appeal, the new CO should send the appeal directly to the officer who imposed punishment.

When the officer who imposed the punishment is in the Navy chain of command, the appeal will normally be sent to the area coordinator authorized to convene GCMs. A GCM authority superior to the officer imposing punishment may, however, set up an alternate route for appeals. Refer to the JAGMAN for more information on NJP appeals.

TIME

Appeals must be submitted in writing within 5 days of the imposition of NJP or the right to appeal is waived in the absence of good cause. The appeal period runs from the date the accused is informed of his or her appeal rights. Normally, this is the day NJP is imposed. When an appeal is submitted more than 5 days after the imposition of NJP (less mailing delay), the officer acting on the appeal determines whether "good cause" was shown for the delay.

Extension of Time

If the accused can show that it would be impossible or extremely difficult to submit the appeal within the 5-day period, the accused should

immediately request an extension of time from the officer who imposed the punishment. The officer imposing NJP determines whether good cause was shown and advises the accused whether an extension of time is permitted.

Request for Stay of Restraint or Extra Duty

A service member who has appealed may be required to undergo any restraint punishment or extra duties imposed while the appeal is pending. If action is not taken on the appeal by the appeal authority within 5 days after the written appeal has been submitted and if the accused has so requested, any remaining restraint or extra duties will be stayed until action on the appeal is taken. The accused should include in his or her written appeal a request for stay of restraint punishment or extra duties; however, a written request for a stay is not specifically required.

CONTENTS OF APPEAL PACKAGE

The appeal package will consist of the appellant's letter of appeal, the endorsement of the officer who imposed the NJP, and the response of the supervising authority.

Appellant's Letter

The appellant's letter should be addressed to the appropriate authority via the commander who imposed the punishment and other appropriate officers in the chain of command. The letter should set forth the obvious features of the nonjudicial punishment (date, offense, who imposed it, and punishment imposed), and detail the specific grounds for relief.

There are only two grounds for appeal: the punishment was unjust, or the punishment was disproportionate to the offense committed. The grounds for appeal are broad enough to cover all reasons for appeal.

UNJUST PUNISHMENT.— Unjust punishment exists when the evidence is not sufficient to prove the charges; when the statute of limitations prohibits lawful punishment; or when any other fact, including a denial of substantial rights, calls in question the validity of the punishment.

DISPROPORTIONATE PUNISHMENT.— Disproportionate punishment is when, in the judgment of the reviewer, the penalty is too severe for the offense committed. When an offender believes the

ACCUSED'S ACKNOWLEDGEMENT OF APPEAL RIGHTS

I, _____, SSN _____.
(Name and grade of accused)

assigned or attached to _____, have been informed of the following facts concerning my rights of appeal as a result of captain's mast held on _____

a. I have the right to appeal to (specify to whom the appeal should be addressed).

b. My appeal must be submitted within a reasonable time. Five days after the punishment is imposed is normally considered a reasonable time, in the absence of unusual circumstances. Any appeal submitted thereafter may be rejected as not timely. If there are unusual circumstances which I believe will make it extremely difficult or not practical to submit an appeal within the 5-day period, I should immediately advise the officer imposing punishment of such circumstances and request an appropriate extension of time in which to file my appeal.

c. The appeal must be in writing.

d. There are only two grounds for appeal; that is:

(1) The punishment was unjust, or

(2) The punishment was disproportionate to the offense(s) for which it was imposed.

e. If the punishment imposed included reduction from the paygrade of E-4 or above, or was in excess of arrest in quarters for 7 days, correctional custody for 7 days, forfeiture of 7 days' pay, extra duties for 14 days, restriction for 14 days, or detention of 14 days' pay, then the appeal must be referred to a military lawyer for consideration and advice before action is taken on my appeal.

(Signature of Accused/Date)

(Signature of Witness/Date)

Figure 6-9.—Accused's acknowledgement of appeal rights.

punishment is too severe, an appeal is made on the grounds of disproportionate punishment. A punishment may be legal but excessive or unfair considering circumstances such as the nature of the offense; the absence of aggravating circumstances; the prior record of the offender; and other circumstances in extenuation and mitigation.

STYLE OF LETTER.— The grounds for appeal need not be stated artfully in the accused's appeal letter, and the reviewer may have to deduce the appropriate grounds implied. Unartful draftsmanship or improper addressees or other administrative irregularities are not grounds for refusing to send the appeal to the reviewing authority. If you note any serious administrative mistakes, correct them in the

SAMPLE NJP APPEAL

5800
11 Feb CY

From: DPSA Jane A. Doe, USN, 333-33-3333
To: Commander Fleet Air Mediterranean
Via: Commanding Officer, U.S. Naval Support Activity, Naples, Italy

Subj: APPEAL FROM NONJUDICIAL PUNISHMENT

Ref (a) Art. 15(e), UCMJ
(b) Part V, par. 7, MCM, 1984
(c) JAGMAN 0116

Encl: (Statements of other persons of facts or matters in mitigation which support the appeal)
(1)
(2)
(3)

1. As provided by references (a) through (c), appeal is herewith submitted from nonjudicial punishment imposed upon me on 10 February 19CY by Captain Jon T. Boate, Commanding Officer, U.S. Naval Support Activity, Naples, Italy.

2. Enclosures (1) through (3) are statements which support my appeal. I am appealing the charges and specifications as follows:

a. Offense(s)

Charge: Violation of Article 134, UCMJ

Specification: In that DPSA Jane A. Doe, USN, was, on board U.S. Naval Support Activity, Naples, Italy, on or about 29 January 19CY, drunk and disorderly.

b. Punishment: Forfeiture of \$250.00 pay per month for 2 months

c. Grounds of Appeal

Punishment for the charge is unjust because I was not really that drunk and unfortunately just lost my balance while dancing and fell into the plate glass window.

JANE A. DOE

Figure 6-10.—Sample NJP letter of appeal.

SAMPLE FIRST ENDORSEMENT TO NJP APPEAL

5800
Ser
13 Feb CY

FIRST ENDORSEMENT on DPSA Jane A. Doe's ltr of 11 Feb CY

From: Commanding Officer, U.S. Naval Support Activity, Naples, Italy

To: Commander Fleet Air Mediterranean

Subj: APPEAL FROM PUNISHMENT ICO DPSA JANE A. DOE, USN, 333-33-3333

Encl: (4) NAVPERS 1626/7 with attachments
(5) DPSA Doe's record of performance (page 9)

1. Forwarded for action. Enclosures (4) and (5) are attached in amplification of the appeal.
2. (This paragraph should contain a statement of facts or circumstances not contained in appellant's letter that would aid in arriving at a proper determination. This information should not be argumentative nor in the form of a "defense" to the matters stated in appellant's letter. See JAGMAN 0116c.)

JON T. BOATE

Figure 6-11.—Sample first endorsement to NJP appeal.

forwarding endorsement. Do not send the appeal back to the accused for redrafting; the appeal should be sent promptly to the reviewing authority. See article 1108, *U.S. Navy Regulations, 1990*, for more information on appeals. Refer to figure 6-10 for a sample of an accused's letter of appeal.

Contents of Forwarding Endorsements

All via addressees should use a simple forwarding endorsement and should not comment on the validity of the appeal. However, the exception to this rule is the endorsement of the officer who imposed the punishment. Section 0116c of the *JAG Manual* requires that this endorsement, shown in figure 6-11, should include the following information:

- A comment on any matters of fact contained in the letter of appeal that the officer who imposed punishment considers inaccurate.
- Include also an account of any facts not otherwise included in the appeal papers. If such factual information was brought out at the mast, the endorsement should so state and include any comment made by the appellant. Any other adverse factual information stated in the endorsement that was not previously documented should be referred to the appellant for comment.
- As an enclosure, a copy of the completed mast report form (NAVPERS 1626/7).
- As enclosures, copies of all documents and signed statements that were considered as evidence at the mast or, if the NJP was imposed on the basis of the record of a court of inquiry or other fact-finding body,

a copy of that record, including the findings of fact, opinions, and recommendations, together with copies of any endorsements.

- As enclosures, copies of the appellant's record of performance as set forth on service record page 9, administrative remarks set forth on page 13, and disciplinary records set forth on page 7.

The officer who imposed the punishment should not, by endorsement, seek to "defend" against the allegations of the appeal but should, where appropriate, explain the rationalization of the evidence. For example, the officer may have chosen to believe one witness while disbelieving another witness. This should be included in the endorsement. The officer who imposed punishment may properly include any facts relevant to the case as an aid to the reviewing authority but should avoid irrelevant character assassination of the accused. Finally, any errors made in the decision to impose nonjudicial punishment or in the amount of punishment imposed should be corrected and the corrective action noted in the forwarding endorsement. Even though corrective action is taken, the appeal must still be sent to the reviewer.

Endorsement of the Reviewing Authority

There are no particular legal requirements on the content of the reviewer's endorsement except to inform the offender of his or her decision. Figure 6-12, section A, shows a sample response by a supervisory authority on an NJP appeal. A legally sound endorsement will include the reviewer's specific decision on each ground of appeal, the basic reasons for the decision, a statement that a lawyer has reviewed the appeal, if such review is required, and instructions for the disposition of the appeal package after the offender receives it.

The endorsement should be addressed to the accused via the appropriate chain of command. Where persons not in the direct chain of command (such as finance officers) are directed to take some corrective action, copies of the reviewer's endorsement should be sent to them. Words of warning or caution, if temperate in tone, are suitable for inclusion in the return endorsement of the reviewer.

Return Endorsement of Via Addressees

If any via addressee has been directed by the reviewer to take corrective action, the accomplishment of that action should be noted in that commander's endorsement. This endorsement should reiterate the steps the reviewer directed the accused to follow in disposing of the appeal package. These instructions should always be to return the appeal to the appropriate commander for filing with the records of his or her case. See figure 6-12, section B, for an example of this endorsement.

Accused's Endorsement

The last endorsement should be from the accused to the CO holding the records of the nonjudicial punishment. See figure 6-12, section C. The endorsement acknowledges receipt of the appeal decision and sends the package back for filing.

POSTMAST ACTIVITY

LEARNING OBJECTIVES: Explain the postmast activity in terms of execution of NJP for enlisted and officer personnel. Describe the UPB. Review the checklist for NJP.

At the completion of NJP it is important that all necessary entries are made in the service record of the member being punished, the POD, the ship or station logbook and finally, the UPB.

EXECUTION OF NJP FOR ENLISTED PERSONNEL

When punishment is imposed as a result of CO's mast, it must be recorded in the accused's service record. Additionally, depending on the type of punishment imposed, certain forms and or letters must be prepared in conjunction with standard service record entries. The following discussion is provided to help you better understand the procedures for preparing these forms and letters used in conjunction with enlisted service record entries.

Confinement Order (NAVPERS 1640/4)

When a member is awarded punishment that includes confinement on bread and water or confinement on diminished rations, a Confinement Order, NAVPERS 1640.4, must be prepared. A

SAMPLE ACTION BY SUPERVISORY AUTHORITY ON NJP APPEAL

5800
Ser
14 Feb CY

From: Commander Fleet Air Mediterranean
To: DPSA Jane A. Doe, USN, 333-33-3333
Via: Commanding Officer, U.S. Naval Support Activity, Naples, Italy
Subj: APPEAL FROM NONJUDICIAL PUNISHMENT ICO DPSA JANE A. DOE

1. Returned, appeal (granted) (denied).
2. Your appeal has been referred to a lawyer for consideration and advice prior to my action.

SECTION

A

3. (Statement of reasons for action on appeal and remarks of admonition and exhortation, if desired.)
4. You are directed to return this appeal and accompanying papers to your immediate commanding officer for filing with the record of your case.

WATER T. DOOR

FIRST ENDORSEMENT on Commander Fleet Air Mediterranean ltr 5800
Ser of 14 Feb CY

From: Commanding Officer, U.S. Naval Support Activity, Naples, Italy
To: DPSA Jane A. Doe, USN, 333-33-3333
Subj: APPEAL FROM PUNISHMENT ICO DPSA JANE A. DOE

SECTION

B

1. Returned for delivery.
2. You are directed to return this appeal and accompanying papers to the legal officer for filing with the record in your case.

JON T. BOATE

SECOND ENDORSEMENT on Commander Fleet Air Mediterranean ltr 5800
Ser of 14 Feb CY

From: DPSA Jane A. Doe, USN, 333-33-3333
To: Commanding Officer, U.S. Naval Support Activity, Naples, Italy
Subj: APPEAL FROM NONJUDICIAL PUNISHMENT

SECTION

C

1. I acknowledge receipt and have noted the contents of the letter on my appeal from nonjudicial punishment.
2. The appeal and all attached papers are returned for filing with the record of my case.

JANE A. DOE

Figure 6-12.-Sample action by supervisory authority on NJP appeal.

CONFINEMENT ORDER			
NAVPERS 1640/4 (Rev. 7-82) S/N 0106-LF-016-4023			
NAME (Last, first, middle)		SSN	RATE/GRADE BRANCH SER
Seaman, Able B.		555-55-5555	BMSR USN
SHIP OR ORGANIZATION		DATE	
Naval Base, Norfolk, Virginia		25 March 19CY	
STATUS			
DETAINED (Alleged violation of UCMJ Articles)		CONFINED AS RESULT OF	
"I have been informed that I am being confined for the above alleged offense(s)"		<input type="checkbox"/> VACATED SUSPENSION <input checked="" type="checkbox"/> NJP <input type="checkbox"/> SCM <input type="checkbox"/> SPCM <input type="checkbox"/> GCM	
		CHARGES AND SPECIFICATION CONVICTED OF Viol Art. 86, UCMJ - UA from 0800, 22 Feb CY until 1530, 22 Mar CY	
SENTENCE ADJUDGED		DATE	
30 days CCU		25 MAR CY	
IF SENTENCE DEFERRED, DATE DEFERMENT TERMINATED			
Date	Signature of accused	SENTENCE APPROVED	APPROVED BY DATE
			CA
			SA
			NCMR
			COMA
			OTHER
PRE TRIAL CONFINEMENT NECESSARY			
<input type="checkbox"/> TO ENSURE THE PRESENCE OF THE ACCUSED AT THE TRIAL		<input type="checkbox"/> BECAUSE OF THE SERIOUSNESS OF THE OFFENSE CHARGED	
CONFINEMENT DIRECTED AT		TYPED NAME/RANK/TITLE	
HOUR	DATE	J. A. Doe, CAPT, USN, CO	
0900	25 MAR CY	SIGNATURE	
		<i>J. A. Doe</i>	
MEDICAL CERTIFICATE			
The above named individual was examined by me at <u>1005</u> (HOUR) on <u>25 MAR CY</u> (DATE) and found to be			
<input checked="" type="checkbox"/> fit <input type="checkbox"/> unfit for confinement. The following irregularities were noted during the examination. (if none, so state)			
<input type="checkbox"/> I certify that from an examination of _____ Name _____ Rank _____ and of the place where he/she is to be confined, I am of the opinion that the execution of the foregoing sentence to confinement on (bread and water) (diminished rations) will/will not produce serious injury to his/her health.			
TYPED NAME/RANK/TITLE		SIGNATURE	
Jon T. Boate, LT, MC, USN		<i>Jon T. Boate</i>	
RECEIPT FOR PRISONER			
The above named individual was received at <u>Correctional Custody Unit, Naval Base, Norfolk, VA.</u> (NAME OF BRIG/CORRECTIONAL FACILITY)			
at <u>1015</u> (HOUR) on <u>25 Mar CY</u> (DATE)			
TYPED NAME/RANK/TITLE		SIGNATURE	
H. H. Hull MACS, USN, OIC		<i>H. H. Hull</i>	

Figure 6-13.—Confinement Order, NAVPERS 1640/4.

sample of a completed confinement order is shown in figure 6-13. In addition to preparing a confinement order, TAD orders must be prepared transferring the accused to the correctional custody facility under the provisions of the *Manual for the Operation of a Waterfront Brig/Correctional Custody Unit* OPNAVINST 1640.7. There are other administrative matters that must be completed when transferring an accused to a correctional custody facility and the specific requirements can be found in SECNAVINST 1640.9 and in SECNAVINST 1640.7, both of which outline the requirements for placing a person into correctional custody and procedures for administering the same.

Letter of Censure

As previously discussed in this lesson, a CO may award as punishment an admonition or a reprimand to the accused. These can be either oral or written in the case of enlisted personnel, and in writing only in cases of commissioned and warrant officers. If the admonition or reprimand is to be written, the format shown in *JAG Manual* 0114f(3) should be used. When either of these types of letter of censure is prepared, careful attention to the requirement outlined in the *JAG Manual* should be followed. When the admonition or reprimand is given orally, as in the case of enlisted personnel, the proper notation must be made on the NAVPERS 1626/7 and recorded in the Punishment Awarded section of the service record page being used to record the results of CO's mast.

Enlisted Service Record Entries

For other punishments that do not affect the pay of an individual (extra duty, restriction, or arrest in quarters), it is good administrative practice to spell out in writing the specific orders on these types of punishment even though there are no specific regulations requiring anything more than a notation in the proper block on the NAVPERS 1626/7. Figures 6-14 and 6-15 show samples of orders to carry out when extra duty and restriction have been awarded as a result of CO's mast.

In some cases involving restriction, your command may not have the facilities to properly administer restriction. In such cases, you should make arrangements with the nearest command that does have the facilities to properly administer restriction, and in these cases the personnel office will be required

to prepare TEMADD orders for the period of punishment.

NJP FOR OFFICERS

We will now have a brief discussion of the procedures involved when an officer receives nonjudicial punishment as a result of CO's mast.

Whenever nonjudicial punishment is imposed upon an officer, the authority imposing the punishment immediately notifies PERS-82 by letter as soon as the results are final. If the officer imposing NJP is not a flag officer, the letter report must be submitted via the first flag officer in the administrative chain of command. These required reports are separate and distinct from any reported NJP that may be contained in investigations or other correspondence. Refer to MILPERSMAN, Article 3410100(2)(b), for the format of the report.

UNIT PUNISHMENT BOOK (UPB)

The Unit Punishment Book (UPB) contains a record of all NJP hearings conducted by a command, not just those in which punishment was awarded, and is required by MILPERSMAN, Article 5030500. The form that is used to record NJP hearings is the NAVPERS 1626/7. When all actions are resolved on a particular NJP hearing, the space provided in the final administrative action portion of the NAVPERS 1626/7 (section J of figure 6-1) should be completed. This final administrative action indicates when the case record is filed and an entry in the UPB should be made.

Though there are no specific instructions as to what manner these cases should be filed in the UPB, the suggested procedure is to file cases in alphabetical order, chronological order by date, or a combination of both.

LOG ENTRIES

The *Standard Organization and Regulations of the U.S. Navy*, (SORM), OPNAVINST 3120.32, prescribes the log entry for mast results afloat. Such an entry should be substantially in the format shown previously for the POD entry, and you should provide this information to the officer of the deck (OOD) for inclusion in the deck log. Although there is no Navywide requirement for logbooks ashore, you will find that logs are kept ashore according to local instructions. Unless these local instructions require a

DEPARTMENT OF THE NAVY
NAVAL BASE
NORFOLK, VIRGINIA 23511

Date

From: Commanding Officer, Naval Base, Norfolk, Virginia
To:

Subj: ORDERS TO CARRY OUT NONJUDICIAL PUNISHMENT

Ref: (a) Manual for Courts-Martial, 1984
(b) U.S. Navy Regulations, 1990

1. You appeared at commanding officer's nonjudicial punishment this date and have been awarded _____ days' extra duty.
2. Immediately upon receipt of these orders, you will report to the Chief Master-at-Arms, Building 27, Naval Base, Norfolk, Virginia, and under his supervision perform the above extra duty. In the event you are not able to perform extra duty because of a watch, being in sick bay, etc., at the time specified by the Chief MAA, you will have your leading petty officer notify him in person or by calling extension 1111 during regular working hours and extension 1000 after normal working hours, Saturdays, or on holidays.
3. The Chief MAA will supervise the extra duty to be performed in accordance with references (a) and (b).
4. The hours of extra duty shall be reasonable, not less than 2 hours per day, and shall be performed outside of normal duties and working hours. Extra duty shall not be performed on Sunday although Sunday counts in the computation of the period for which such punishment is imposed.
5. Any failure to carry out these orders will result in further disciplinary action.
6. Upon completion of this punishment, the Chief MAA will notify the commanding officer, via the discipline officer, that such punishment has been completed.

Discipline Officer
By direction

I have read the above orders to the individual named and have delivered to him one copy.

Discipline Officer/Master-at-Arms

Copy to:
CMAA
Accused's LPO

Figure 6-14.—Sample letter of orders to carry out NJP punishment of extra duty.

DEPARTMENT OF THE NAVY
NAVAL BASE
NORFOLK, VIRGINIA 23511

Date

From: Commanding Officer, Naval Base, Norfolk, Virginia
To:

Subj: INSTRUCTIONS FOR CARRYING OUT PUNITIVE RESTRICTION

1. You appeared at commanding officer's nonjudicial punishment this date and have been awarded _____ days' restriction without suspension from duty.

2. The limits of your restriction are the confines of the Naval Base, Norfolk, Virginia proper. This excludes any recreational facilities on board the base.

3. You will report and muster at the following times:

With the Master-at-Arms, Building 27

Weekdays: 0745, 1230, and 1600

With the OOD, Quarterdeck, Building 27

Weekdays: 2000 and 2200

Saturdays, Sundays, and Holidays: 0745, 1000, 1230, 1400,
1600, 2000, and 2200

The above musters will be in the uniform of the day.

4. Additional rules concerning your restriction will be found on the reverse side of this form. You will read these additional instructions and sign the acknowledgement below.

Discipline Officer
By direction

I have read and fully understand the instructions concerning my restriction and I hereby acknowledge receipt of one (01) signed original of these orders.

Witness

Signature of person being restricted

DISTRIBUTION:

Original to person being restricted

CMAA

OOD

Discipline Officer

Figure 6-15.—Sample letter of instruction for carrying out punitive restriction.

different format, you should provide information about the mast results to the OOD in the same format that is used afloat.

NJP CHECKLIST

Figure 6-16, checklist for report chit/NJP processing, is provided for you as a guide in helping you to carry out all the responsibilities inherent in nonjudicial punishment proceedings.

SUMMARY

Nonjudicial punishment is the lowest form of discipline available to COs to aid them in maintaining good order and discipline within the Navy. As you can see from the preceding discussion, there are many things to consider when the various aspects of nonjudicial punishment are carried out. It is important for you, as an MA, to keep abreast of all the requirements and procedures associated with the proper administration of NJP because of its effect upon individuals as well as its effect upon the Navy.

CHECKLIST FOR REPORT CHIT/NJP PROCESSING

The following process assumes that the command has a local report chit or system for reporting offenses and conducting the preliminary inquiry prior to the preparation of a NAVPERS 1626/7 for use at XOI or CO's mast.

A. BEFORE CO's MAST

1. Log local report into the logbook. (A log should be used for tracking the report through your command.)
2. Send local report and request for preliminary inquiry and recommendation as to disposition to SNM's department head.
3. If returned recommending XOI or mast, check service record out from personnel or PSD.
4. Review service record to ensure all pages are there and to determine if SNM is on any suspended sentence, is in a frocked paygrade, or has been given an administrative separation warning.
5. Prepare NAVPERS 1626/7 and appropriate acknowledgement of rights from *JAG Manual*. If a UA case, be sure to have a page 601/6R or page 13.
6. Attach preliminary inquiry report, including statements and other evidence, to report chit.
7. Contact and inform the accused of all rights and let him or her inspect the evidence. (If shore-based, set up appointment with defense counsel if accused wants to consult with counsel.)
8. Inform accused, his or her supervisors, and witnesses of time and place of XOI/CO's mast.

B. AFTER CO's MAST

1. Ensure CO has completed section of NAVPERS 1626/7 entitled Action of the Commanding Officer.

Figure 6-16.—Checklist for report chit/NJP processing.

2. Inform accused of right to appeal NJP. Be sure accused signs the appropriate forms. Ensure NAVPERS 1626/7 is modified to reflect the 5-day time limit vice 15 days which is preprinted on NAVPERS 1626/7.

3. Ensure personnel prepares necessary service record entries.

a. Service record entries required when the commanding officer EXCUSES or DISMISSES the offense(s):

(1) When the service record contains an entry concerning UA, an entry must be made to show what action was taken. If the UA is less than 24 hours, a page 13 entry is required.

(2) If UA is more than 24 hours, completion of a page 601-6R is required.

(3) For all other offenses EXCUSED or DISMISSED, no service record entry is required. If UA offense excused or dismissed, page 13 required to reflect the disposition.

b. When mast results in a decision to refer charges to trial by summary or special court-martial, prepare a Charge Sheet, DD 458. No service record entry is required.

c. When mast results in a decision to refer charges to a pretrial investigation under Article 32, no service record entry is required.

d. Required service record entries if punishment imposed:

(1) Punishments NOT including reduction or forfeiture of pay:

(a) NAVPERS 1070/613 (Page 13)

(b) NAVPERS 1070/609 (Page 9)

(c) NAVPERS 1070/606 (Page 6) - Must be completed in UA cases in excess of 24 hours. Since UA of 24 hours or more is lost time, completion of the page 6 (blocks 1 and 2, 38 through 42, and block 50) must be timely and accurate. Strict adherence to the PAYPERSMAN, section 90435, is mandatory.

(2) Punishment including reduction or forfeiture of pay:

(a) NAVPERS 1070/607 (Page 7)

(b) NAVPERS 1070/609 (Page 9)

(c) NAVPERS 1070/604 (Page 4) if reduction awarded.

(d) NAVPERS 1070/606 (Page 6) to be completed in UA cases in excess of 24 hours as outlined above.

Figure 6-16.—Checklist for report chit/NJP processing-Continued.

(e) If reduction and forfeitures, ensure forfeitures are based on reduced paygrade (even if reduction suspended). NOTE: *Manual of Advancement*, BUPERSINST 1430.16, section 301.12.17 states that all lost time in excess of 15 days as a result of UA, sick, misconduct, confinement, etc., is not creditable in computing service in paygrade. When cumulative lost time is in excess of 15 days in the same paygrade, adjust TIR date by adding the number of days' lost days, ONLY if there has been NO REDUCTION IN RATE.

(3) Punishments involving reduction, or forfeiture of pay which are suspended:

(a) NAVPERS 1070/613 (Page 13) if punishment awarded pertains to RIR or FF and was suspended.

(b) NAVPERS 1070/607 (Page 7) if one or more types of punishment awarded is suspended, but still included at least one punishment not suspended that pertains to pay.

(c) NAVPERS 1070/609 (Page 9) if reduction is awarded.

(d) NAVPERS 1070/604 (Page 4) if reduction is awarded.

(4) Punishments involving restraint:

(a) Correctional custody. If CC is awarded at mast, Temporary Additional Duty (TEMADD) orders with a copy of the NAVPERS 1626/7, Report and Disposition of Offense(s) attached must accompany the accused. NOTE: The accused will be escorted to the local medical facility for a preconfinement physical.

(b) Restriction to limits. If restriction is imposed, restriction papers need to be typed. Usually this is on a local preprinted form, necessitating only the completion of the accused's name, rate, and social security number. It will show the boundaries of restriction, times, dates, and places for muster, and is signed by someone authorized to do so.

(c) Extra duty. If extra duty is imposed, virtually the same procedure as in (b) above will be used. Again, notification is by preprinted locally prepared form which defines the extra duty, the time it will be accomplished, to whom the accused reports, and any extra instructions necessary.

(d) Confinement on bread and water. Prepare confinement orders for bread and water. The accused must be given a confinement physical and found to be fit for confinement on bread and water.

(e) File documents in UPB and, after all action (including any appeal), ensure it is complete.

(5) Remission, mitigation, or setting aside of NJP.

(a) The PAYPERSMAN (part 9, section 90436) contains block-by-block instructions for preparation of NAVPERS 1070/607 for these actions.

Figure 6-16.-Checklist for report chit/NJP processing—Continued.

(b) Refer to table 9-4-39h for instructions to mitigate, reinstate, or set aside the punishment for members who have previously been reduced in rate.

C. MISCELLANEOUS MATTERS

1. If the CO's NJP results in a restraint-type punishment, the details must be furnished to the OOD for inclusion in the deck log.

2. Prepare notice for POD. If it is the policy of commands to publish the results of CO's NJP in the command POD, strict compliance with JAGMAN 0115 is mandatory. (It is suggested that names of the offenders be omitted if the information may be disseminated to civilians.) In no instance will the social security number of an individual be used in the publication of NJP results. (See SECNAVINST 5211.5.)

3. If appropriate, prepare page 13—warning member of consequences of future misconduct.

4. If a basis for administrative discharge applies, determine if command wants to process member for discharge.

D. NJP APPEALS

1. After receipt of accused's appeal, prepare written endorsement for the CO's signature. Include a copy of NAVPERS 1626/7, copies of all statements or evidence used at mast, and copy of page 9 from accused's service record (with all endorsements). See JAGMAN 0116 for requirements.

2. Indicate appeal on NAVPERS 1626/7.

3. If no response to appeal is received from appeal authority within 5 days to accused's appeal, then restraint punishments must be stayed if accused has requested this.

E. OFFICER'S NJP

1. Before taking an officer to NJP, check with regulations promulgated by the type commander regarding any additional requirements or procedures required by them. (Many want notification prior to the NJP hearing. CINCPACFLT commands must have a prompt verbal report of all incidents of officer misconduct to CINCPACFLT).

2. If an officer is awarded NJP, then a disciplinary report must be sent to NMPC 82. (MILPERSMAN 3410100.2b contains the applicable provisions.)

3. If the officer is also being detached for cause, consult MILPERSMAN 3410105 for the provisions for this procedure.

Figure 6-16.-Checklist for report chit/NJP processing-Continued.

CHAPTER 7

CONTROLLED SUBSTANCES

“The illegal use of drugs by members of the Armed Forces is a matter of concern that requires intensive, coordinated departmental effort for its control and elimination. The heavy responsibilities of members of the Armed Forces make drug abuse by any member a matter of serious concern which dictates intensive effort to eliminate it.” (Report of the Department Task Force on Narcotic and Drug Abuse)

In this chapter we will discuss and try to familiarize you with the most common narcotics and dangerous drugs with which the Master-at-Arms (MA) may come in contact. The drug scene is ever changing and, based on availability and trend, a few drugs will be more popular at one time than another. Oftentimes a certain drug will become unpopular to drug abusers because of its high cost or because it is no longer considered “safe.” A newer drug or revised version of an old drug will then take its place and become the “now thing.”

COMMAND RELATIONSHIP TO DRUG ABUSE

LEARNING OBJECTIVES: State the Navy's policy on drug abuse in terms of an initial drug offense and the punishment awarded. Identify the maximum punishments the Navy imposes on unlawful possession and use of controlled substances.

Most drug abuse involves substances like marijuana, LSD, and heroin which have no legitimate medical use. However, some of the drugs that are abused—principally morphine, amphetamine, and the barbiturates—are invaluable tools for the physician who strives to cure and alleviate disease.

The important factor in drug abuse is the abuser, not the drug. Drugs have a definite place in our society and should be treated with respect. When drugs are abused, both the individual and society suffer. Because of this concern for the individual and society,

drug abuse and its related problems must be discussed fully.

Drug abuse has a particularly important consequence for the armed forces. Unlike civilians, those in military service have a special dependency on each other. The lives of everyone on a Navy ship may depend on the alertness of one person assigned to close certain watertight doors. Each member of the Seabee fire team is dependent on other team members for survival in a combat situation. There are no “passengers” in fighter aircraft or bombers. No commanding officer (CO) can trust the fate of his or her unit, ship, or plane to someone under the influence of drugs.

The drug abuser in military service is a definite security risk. For example, the drug abuser can be blackmailed by threat of exposure. The abuser can be led to sell or give away classified information to support a drug habit. Also, while under the influence of narcotics, the abuser may overlook or ignore proper security measures.

In military law, wrongful acts concerning narcotics and marijuana have traditionally been charged as “conduct prejudicial to good order and military discipline.” In the past years, mandatory processing for separation of first-time drug abuse offenders was expanded to include all officer and petty officer paygrades and this policy has been very effective in deterring drug abuse. But on 01 March 1992, the Navy changed its drug policy to fully support a “zero tolerance” to drug abuse. Effective that date, processing for separation of all first time drug abuse offenders for all Navy paygrades became mandatory, using the following policy:

- A. All Navy personnel in paygrades E-1 and above who commit an initial drug offense shall be disciplined as appropriate, screened for drug dependency, and processed for separation. Individuals separated administratively or punitively who are medically diagnosed as drug dependent shall be offered Department of Veterans Affairs treatment at time of separation.

NONNARCOTIC DRUG ABUSE

- B. Self-referral for drug abuse is an incident of drug abuse and does not prevent a member from being administratively processed for separation.
- C. For this policy to apply to drug abuse incidents identified through urinalysis, samples must be obtained on, or subsequent to 01 MAR 92.

Further information on separation of drug abuse individuals can be obtained from *Alcohol and Drug Abuse Prevention and Control OPNAVINST 5350.4*, and the *Uniform Code of Military Justice (UCMJ)*, Article 112a.

The *Manual for Courts-Martial (MCM)* provides the following maximum punishments for wrongful use, possession, and so on, of controlled substances. See table 7-1.

As for the abuser—and potential abuser—of nonnarcotics, there is a growing recognition of the value of an educational, rather than a punitive approach. Through an energetic program of drug abuse education, the rate of those who experiment has declined.

LEARNING OBJECTIVES: Discuss the history of nonnarcotic drug abuse in the United States. List some of the nonnarcotic drugs that have been abused.

In years past, public attention has focused on the abuse of nonnarcotic drugs such as amphetamines (stimulants), barbiturates (sedatives), certain tranquilizers, and “hallucinogens.” The growing trend toward abuse of these drugs was noted by the White House Conference on Narcotics and Drug Abuse in 1962. Much of the awareness has come from newspaper and magazine articles reporting widespread abuse of nonnarcotic drugs by high school and college youth. Though the extent of use is unknown, there is considerable evidence that the problem is growing. In 1966, the Medical Society of New York reported that while drug abuse in the city’s high schools or the state’s colleges was not extensive, marijuana, LSD, and similar drugs “may soon present a dangerous problem.” The medical society report blamed this possibility, in part, on “frequent

Table 7-1.—Maximum Punishments for Controlled Substances

Type of Controlled Substance Abuse	Type of Discharge	Length of Confinement	Amount of Forfeiture
Wrongful use, possession, manufacture, or introduction of:			
• Amphetamine, cocaine, heroin, lysergic acid diethylamide, marijuana (except use or possession of less than 30 grams), methamphetamine, opium, phencyclidine, secobarbital, and Schedule I, II, and III controlled substances	DD, BCD	5 yr	Total
• Marijuana (except use or possession of less than 30 grams), phenobarbital, and Schedule IV and V controlled substances	DD, BCD	2 yr	Total
Wrongful distribution of, or, with intent to distribute, wrongful possession, manufacture, introduction, or wrongful importation or exportation of:			
• Amphetamine, cocaine, heroin, lysergic acid diethylamide, marijuana, methamphetamine, opium, encyclidine, secobarbital, and Schedule I, II, and III controlled substances	DD, BCD	15 yr	Total
• Phenobarbital and Schedule IV and V controlled substances	DD, BCD	10 yr	Total

glorification of hallucinogens without adequate details regarding their danger.” Subsequent reports by the American Medical Association (AMA) have further confirmed this study.

Public opinion has tended to regard the nonnarcotic abuser (except, perhaps, for the marijuana offender) with less harshness than the narcotic addict. In part, this may reflect the public’s association of nonnarcotic drugs with occasional or “spree” use, the social acceptance and widespread use of amphetamines and barbiturates in legitimate medical therapy, and the availability of such drugs from other than underworld contacts. Also, while the dangers of narcotic addiction are acknowledged, the dangers inherent in many nonnarcotics have not been generally recognized.

The net result of this thinking has been to curtail misuse of nonnarcotics by laws aimed at the source rather than the user. Accordingly, in 1965, proceeding from a recommendation by the President’s Advisory Commission on Narcotic and Drug Abuse, the Drug Abuse Control Amendments were added to the Food, Drug and Cosmetic Act of 1938. The purpose of these amendments was to eliminate illegal traffic in amphetamines, barbiturates, and drugs of abuse other than narcotics and marijuana. To enforce these amendments, a Bureau of Drug Abuse Control has been created under the Food and Drug Administration (FDA) to regulate distribution of amphetamines, barbiturates, and other abused nonnarcotic drugs.

In 1968, the Bureau of Drug Abuse Control and the Federal Bureau of Narcotics were merged into a single agency, the Bureau of Narcotics and Dangerous Drugs (BNDD), in the Justice Department. In 1973 BNDD and several other agencies were combined to form the agency known as the Drug Enforcement Administration (DEA).

From 1968 to the present, drug abuse has grown at an alarming rate throughout the world, but especially in the United States.

DRUG TERMINOLOGY

LEARNING OBJECTIVES: Define the most commonly used drug and drug abuse terms.

In your dealings with narcotics and dangerous drugs, you will find the following terms are those most commonly used.

Narcotics— Any preparations or derivatives of opium, synthetic narcotics, opiates, or cocaine. Examples are opium, heroin, morphine, codeine, paregoric, dilaudid, pethidine, and methadone. Note that federal law defines cocaine as a narcotic, though medical science classifies it as a stimulant only.

Dangerous drugs (an administrative label)— Nonnarcotic substances that the Attorney General or designee, after investigation, has found to have, and by regulation designates as having, a potential for abuse because of their depressant or stimulant effect on the central nervous system or their hallucinogenic effect (Public Law 91-5 13).

Controlled Substances— A drug, or other substance or immediate precursor thereof, listed in the current schedules of Title 21, *U.S. Code* (U.S.C.), Section 812.

Depressant— Any of several drugs that calm or sedate by acting on the central nervous system. Medical uses include the treatment of anxiety, tension, and high blood pressure.

Sedative— An agent that quiets or calms activity.

Stimulant— Any of several drugs that act on the central nervous system, producing excitation, alertness, and wakefulness. Medical uses include the treatment of mild depressive states, overweight, and narcolepsy.

Hallucinogen— Any of several drugs, popularly called psychedelics, that produce sensations such as distortions of time, space, sound, color, and other bizarre effects. While they are pharmacologically nonnarcotic, some of these drugs are regulated under federal narcotic laws.

Hypnotic— An agent that induces sleep.

Central nervous system— The brain and spinal cord.

Convulsions— An involuntary and violent irregular series of contractions of the muscles.

Delirium— A condition characterized by mental excitement, confusion, disordered speech and, often, hallucinations.

Drug abuse— Illegal, wrongful, or improper use of any narcotic substance, marijuana, or other dangerous drug, or the illegal or wrongful possession, sale, transfer, delivery, or manufacture of the same. When such drugs have been prescribed by competent

medical personnel for medical purposes, their proper use by the patient is not drug abuse.

Drug abuser— One who has illegally, wrongfully, or improperly used any narcotic substance, marijuana, or dangerous drug, or who has, for whatever reason, illegally or wrongfully possessed, sold, transferred, delivered, or manufactured the same.

Drug experimenter— One who has illegally, wrongfully, or improperly used drugs for a specific purpose. The exact number of usages is not necessarily as important in determining the category of user as is the intent of the user, the circumstances of use, and the psychological makeup of the user.

Drug user spree— One who has illegally, wrongfully, or improperly used drugs for “kicks” or for the experience. Some persons falling under this category may only try drugs a couple of times and stop. Personnel in this category usually take drugs in groups or at social functions. There is little psychological dependence.

Drug addict (hard core)— One whose activities revolve almost entirely around drug experiences and securing supplies. As the term drug addict is used herein, three conditions must be present:

1. The individual must have developed a tolerance for the drug.
2. The individual must have developed a psychological or compulsive dependence, and drug effects must be necessary to maintain a state of well-being.
3. The individual must have developed physiological dependence on the drug and, in the absence of the drug, must exhibit the withdrawal syndrome. This dependence results from an altered physiological state from prolonged drug use that necessitates continued use to avoid withdrawal symptoms.

Drug dependence— A state arising from repeated administration of a drug on a periodic or continual basis. Its characteristics will vary with the agent involved. That is made clear by designating the particular type of drug dependence in each specific case—for example, drug dependence of the morphine type, of the cocaine type, of the cannabis type, of the barbiturate type, and so on.

Physical dependence— Physiological adaptation of the body to the presence of the drug. In effect, the body develops a continuing need for the drug. Once

such dependence has been established, the body reacts with predictable symptoms if the drug is abruptly withdrawn. The nature and severity of withdrawal symptoms depend on the drug being used and the daily dosage level attained.

Psychological dependence— An attachment to drug use that arises from a drug’s ability to satisfy some emotional or personality need of an individual. This attachment does not require a physical dependence, although physical dependence may seem to reinforce psychological dependence. An individual may also be psychologically dependent on substances other than drugs.

Psychosis— A major mental disorder; any serious mental derangement.

Habituation— A condition, resulting from the repeated consumption of a drug, that includes these characteristics: (1) a desire (but not a compulsion) to continue taking the drug for the sense of improved well-being that it engenders; (2) little or no tendency to increase the dose; (3) some degree of psychic dependence on the effect of the drug, but absence of physical dependence and, hence, no abstinence syndrome; (4) a detrimental effect, if any, primarily on the individual.

Potentiation— Potentiation occurs when the combined action of two or more drugs is greater than the sum of the effects of each drug taken alone. Potentiation can be very useful in certain medical procedures. For example, physicians can induce and maintain a specific degree of anesthesia with a small amount of the primary anesthetic agent. Potentiation may also be dangerous. For example, barbiturates and many tranquilizers potentiate the depressant effects of alcohol.

Tolerance— With many drugs, a person must keep increasing the dosage to maintain the same effect. This characteristic is called tolerance. Tolerance develops with the barbiturates, with amphetamines and related compounds, and with opiates.

Toxic effects (poisoning)— Any substance in excessive amounts can act as a poison or toxin. With drugs, the margin between the dosage that produces beneficial effects and the dosage that produces toxic or poisonous effects varies greatly. Moreover, this margin will vary with the person taking the drug.

Side effects— A given drug may have many actions on the body. Usually one or two of the more prominent actions will be medically useful. The

others, usually weaker effects, are called side effects. They are not necessarily harmful, but may be annoying.

Supplier— One who furnishes illegally, wrongfully, or improperly to another person for gain any of the drugs defined earlier.

Casual supplier— One who furnishes illegally, wrongfully, or improperly to another person, a small amount of any of the drugs defined herein for the convenience of the user rather than for gain.

FEDERAL LAWS CONCERNING DRUGS

LEARNING OBJECTIVES: Explain the formal scheduling of drugs. List four items that determine a drug's potential for abuse, and identify eight factors that determine the schedule into which a drug should be placed. Identify the characteristics of each of the five schedules of drugs. Explain temporary drug scheduling, controlled substance analogues, and international drug treaty obligations.

The Federal Controlled Substances Act (FCSA), Title II, of the Comprehensive Drug Abuse Prevention and Control Act of 1970, is the legal foundation of the government's fight against abuse of drugs and other substances. This law is a consolidation of numerous laws regulating the manufacture and distribution of narcotics, stimulants, depressants, and hallucinogens. Drugs may be placed on the FCSA by administrative or legislative acts passed by Congress. More recently, in 1988, Congress passed the Chemical Diversion and Trafficking Act. This Act allows for the regulation of certain chemicals that are used in the making of controlled substances.

FORMAL SCHEDULING

The FCSA places all substances that are in some manner regulated under existing federal law into one of five schedules. This placement is based upon the substance's medical use, potential for abuse, and safety or dependence liability. The act also provides a mechanism for substances to be controlled, or added to a schedule; decontrolled, or removed from control; and rescheduled or transferred from one schedule to another. The procedure for these actions is found in Section 201 of the FCSA (21 U.S.C. 811).

Proceedings to add, delete, or change the schedule of a drug or other substance may be initiated by the Department of Health and Human Services (HHS), by the DEA, or by petition from any interested person—the manufacturer of a drug, a medical society or association, a pharmacy association, a public interest group concerned with drug abuse, a state or local government agency, or an individual citizen. When a petition is received by the DEA, the agency begins its own investigation of the drug.

The agency also may begin an investigation of a drug at any time based upon information received from law enforcement laboratories, state and local law enforcement and regulatory agencies, or other sources of information.

Once the DEA has collected the necessary data, the administrator of the DEA, by authority of the Attorney General, requests from HHS a scientific and medical evaluation and recommendation as to whether the drug or other substance should be controlled or removed from control. This request is sent to the Assistant Secretary of Health of HHS. HHS solicits information from the Commissioner of FDA, evaluations and recommendations from the National Institute on Drug Abuse, and, on occasion, from the scientific and medical community at large. The Assistant Secretary (by authority of the Secretary) compiles the information and transmits back to the DEA a medical and scientific evaluation regarding the drug or other substance—a recommendation as to whether the drug should be controlled, and in what schedule it should be placed.

The medical and scientific evaluations are binding on the DEA with respect to scientific and medical matters. The recommendation on scheduling is binding only to the extent that if HHS recommends that the substance not be controlled, the DEA may not control the substance.

The threshold issue is whether the drug or other substance has potential for abuse. If a drug does not have a potential for abuse, it cannot be controlled. Although the term *potential for abuse* is not defined in the FCSA, there is much discussion of the term in the legislative history of the act. The following items are indicators that a drug or other substance has a potential for abuse:

- There is evidence that individuals are taking the drug or drugs containing such a substance in amounts sufficient to create a hazard to their health or to the safety of other individuals or of the community.

- There is significant diversion of the drug or drugs containing such a substance from legitimate drug channels.

- Individuals are taking the drug or drugs containing such a substance on their own initiative rather than on the basis of medical advice from a practitioner licensed by law to administer such drugs in the course of his or her professional practice.

- The drug or drugs containing such a substance are new drugs so related in their action to a drug or drugs already listed as having a potential for abuse to make it likely that the drug will have the same potentiality for abuse as such drugs, thus making it reasonable to assume that there may be significant diversions from legitimate channels, significant use contrary to or without medical advice, or that it has a substantial capability of creating hazards to the health of the user or to the safety of the community. Of course, evidence of actual abuse of a substance is indicative that a drug has a potential for abuse.

In determining into which schedule a drug or other substance should be placed, or whether a substance should be decontrolled or rescheduled, certain factors should be considered. Specific findings are not required for each factor. These factors are listed in Section 201 (c), 21 U.S.C. 811 (c), of the FCSA and are as follows:

(1) The drug's actual or relative potential for abuse.

(2) Scientific evidence of the drug's pharmacological effects. The state of knowledge with respect to the effects of a specific drug is, of course, a major consideration. It is vital to know, for example, whether or not a drug has a hallucinogenic effect if it is to be controlled because of that. The best available knowledge of the pharmacological properties of a drug should be considered.

(3) The state of current scientific knowledge regarding the substance. Criteria (2) and (3) are closely related. However, (2) is primarily concerned with pharmacological effects and (3) deals with all scientific knowledge with respect to the substance.

(4) Its history and current pattern of abuse. To determine whether or not a drug should be controlled, it is important to know the pattern of abuse of that substance, including the socioeconomic characteristics of the segments of the population involved in such abuse.

(5) The scope, duration, and significance of abuse. In evaluating existing abuse, the administrator must know not only the pattern of abuse but whether the abuse is widespread. In reaching his or her decision, the administrator should consider the economics of regulation and enforcement attendant to such a decision. In addition, he or she should be aware of the social significance and impact of such a decision upon those people, especially the young, that would be affected by it.

(6) What risk, if any, there is to the public health. If a drug creates dangers to the public health, in addition to or because of its abuse potential, then these dangers must also be considered by the administrator.

(7) The drug's psychic or physiological dependence liability. There must be an assessment of the extent to which a drug is physically addictive or psychologically habit-forming, if such information is known.

(8) Whether the substance is an immediate precursor of a substance already controlled. The FCSA allows inclusion of immediate precursors on this basis alone into the appropriate schedule and thus safeguards against possibilities of clandestine manufacture.

After considering the previous listed factors, the administrator must make specific findings concerning the drug or other substance. This will determine into which schedule the drug or other substance will be placed. These schedules are established by the FCSA. They are as follows.

Schedule I

- The drug or other substance has a high potential for abuse.
- The drug or other substance has no currently accepted medical use in treatment in the United States.
- There is a lack of accepted safety for use of the drug or other substance under medical supervision.

Schedule II

- The drug or other substance has a high potential for abuse.
- The drug or other substance has a currently accepted medical use in treatment in the United States or a currently accepted medical use with severe restrictions.

- Abuse of the drug or other substance may lead to severe psychological or physical dependence.

Schedule III

- The drug or other substance has a potential for abuse less than the drugs or other substances in Schedules I and II.

- The drug or other substance has a currently accepted medical use in treatment in the United States.

- Abuse of the drug or other substance may lead to moderate or low physical dependence or high psychological dependence.

Schedule IV

- The drug or other substance has a low potential for abuse relative to the drugs or other substances in Schedule III.

- The drug or other substance has a currently accepted medical use in treatment in the United States.

- Abuse of the drug or other substance may lead to limited physical dependence or psychological dependence relative to the drugs or other substances in Schedule III.

Schedule V

- The drug or other substance has a low potential for abuse relative to the drugs or other substances in Schedule IV.

- The drug or other substance has a currently accepted medical use in treatment in the United States.

- Abuse of the drug or other substances may lead to limited physical dependence or psychological dependence relative to the drugs or other substances in Schedule IV.

When the administrator of the DEA has determined that a drug or other substance should be controlled, decontrolled, or rescheduled, a proposal will be published in the *Federal Register* setting forth the schedule for which control is proposed, or that a substance should be decontrolled, and inviting all interested persons to file comments with the DEA. Affected parties may also request a hearing with the DEA. If no hearing is requested, the DEA will evaluate all comments received and publish a final order in the *Federal Register*, controlling the drug as proposed or

with modifications based upon the written comments filed. This order will set the effective dates for imposing the various requirements imposed under the FCSA.

If a hearing is requested, the DEA will enter into discussions with the party or parties requesting a hearing in an attempt to narrow the issue for litigation. If necessary, a hearing will then be held before an administrative law judge. The judge will take evidence on factual issues and hear arguments on legal questions regarding the control of the drug. Depending on the scope and complexity of the issues, the hearing may be brief or quite extensive. The administrative law judge, at the close of the hearing, prepares findings of fact and conclusions of law and a recommended decision that is submitted to the administrator of the DEA. The administrator will review these documents, as well as the underlying material, and prepare his or her own findings of fact and conclusions of law (which may or may not be the same as those drafted by the administrative law judge). The administrator then publishes a final order in the *Federal Register*, either scheduling the drug or other substance, or declining to do so.

Once the final order is published in the *Federal Register*, interested parties have 30 days to appeal to a U.S. Court of Appeals to challenge the order. Findings of fact by the administrator are deemed conclusive if supported by "substantial evidence." The order imposing controls is not stayed during the appeal, however, unless so ordered by the court.

EMERGENCY OR TEMPORARY SCHEDULING

In 1984, the FCSA was amended by the Comprehensive Crime Control Act of 1984. This act included a provision that allows the administrator of the DEA to place a substance, on a temporary basis, into Schedule I when necessary to avoid an imminent hazard to the public safety.

This emergency scheduling authority permits the scheduling of a substance that is not currently controlled, is being abused, and is a risk to the public health while the formal rulemaking procedures described in the FCSA are being conducted. This emergency scheduling applies only to substances with no accepted medical use. A temporary scheduling order may be issued for 1 year with a possible extension of up to 6 months if formal scheduling procedures have been initiated. The proposal and

order are published in the *Federal Register* as are the proposals and orders for formal scheduling.

During this time period, the DEA is required, by law, to complete the traditional scheduling process in order to permanently keep the drug or substance in Schedule I of the FCSA. The traditional scheduling process involves the collection, by the DEA, of all information pertaining to the chemistry, pharmacology, toxicology, abuse, and trafficking of the drug or substance. This data will ultimately be used by the DEA and HHS to decide the permanent scheduling of the drug or substance.

CONTROLLED SUBSTANCE ANALOGUES

A new class of substances was created by the Anti-Drug Abuse Act of 1986. Controlled substance analogues are substances that are not controlled substances, but may be found in the illicit traffic. They are structurally or pharmacologically similar to Schedule I or II controlled substances. A controlled substance analogue has no legitimate medical use. A substance that meets the definition of a controlled substance analogue that is intended for human consumption is treated under the FCSA as if it were a controlled substance in Schedule I.

INTERNATIONAL TREATY OBLIGATIONS

United States treaty obligations may require that a drug or other substance be controlled under the FCSA, or rescheduled if existing controls are less stringent than those required by the treaty. The procedures for these scheduling actions are found in Section 201 (d) of the FCSA.

The United States is a party to the Single Convention on Narcotic Drugs of 1961, designed to establish effective control over international and domestic traffic in narcotics, coca leaf, cocaine, and cannabis. A second treaty, the Convention on Psychotropic Substances of 1971, which entered into force in 1976, is designed to establish comparable control over stimulants, depressants, and certain hallucinogens. Congress ratified this treaty in 1980.

REGULATIONS

LEARNING OBJECTIVES: Explain the registration, recordkeeping, distribution, and security of drugs according to the Federal Controlled Substances Act (FCSA).

The FCSA creates a closed system of distribution for those authorized to handle controlled substances. The cornerstone of this system is the registration of all those authorized by the DEA to handle controlled substances. All individuals and firms that are registered are required to maintain complete and accurate inventories and records of all transactions involving controlled substances, as well as security for the storage of controlled substances. See table 7-2.

REGISTRATION

Any person who handles or intends to handle controlled substances must obtain a registration issued by the DEA. A unique number is assigned to each legitimate handler of controlled drugs—importer, exporter, manufacturer, wholesaler, hospital, pharmacy, physician, and researcher. This number must be made available to the supplier by the customer before the purchase of a controlled substance. Thus, the opportunity for unauthorized transactions is greatly diminished.

RECORDKEEPING

The FCSA requires that complete and accurate records be kept of all quantities of controlled substances manufactured, purchased, and sold. Each substance must be inventoried every 2 years. Some limited exceptions to the recordkeeping requirements may apply to certain categories of registrants.

From these records it is possible to trace the flow of any drug from the time it is first imported or manufactured through the wholesale level, to the pharmacy or hospital that dispensed it, and then to the actual patient who received the drug. The mere existence of this requirement is sufficient to discourage many forms of diversion. It actually serves large corporations as an internal check to uncover diversion, such as pilferage by employees.

There is one distinction between scheduled items for recordkeeping requirements. Records for Schedule I and II drugs must be kept separate from all other records of the handler; records for Schedule III, IV,

Table 7-2.—Regulatory Requirements

SCHEDULE	REGIS-TRATION	RECORD-KEEPING	DISTRIBUTION RESTRICTIONS	DISPENSING LIMITS	REGULATORY REQUIREMENTS			IMPORT / EXPORT		MANUFACTURER / DISTRIBUTOR REPORTS TO DEA	
					MANUFACTURING		NARCOTIC	NON-NARCOTIC	NARCOTIC	NON-NARCOTIC	
					SECURITY	QUOTAS					
I	required	separate	order forms	research use only	vault / safe	yes	permit	permit	yes	yes	
II	required	separate	order forms	Rx: written; no refills	vault / safe	yes	permit	permit	yes	yes	
III	required	readily retrievable	records required	Rx: written or oral; with medical authorization, refills up to 5 in 6 months	secure storage area	NO but some drugs limited by Schedule II	permit	permit	yes	**	
IV	required	readily retrievable	records required	Rx: written or oral; with medical authorization, refills up to 5 in 6 months	secure storage area	NO but some drugs limited by Schedule II	permit	declara-tion	Manufac-turer only	**	
V	required	readily retrievable	records required	OTC (Rx drugs limited to M.D.'s order)	secure storage area	NO but some drugs limited by Schedule II	permit to import, declaration to export	declara-tion	Manufac-turer only	no	

* Permit for some drugs, declaration for others

** Manufacturer reports required for specific drugs

and V substances must be kept in a “readily retrievable” form. The former method allows for more expeditious investigations involving the highly abusable substances in Schedules I and II.

DISTRIBUTION

The keeping of records is required for distribution of a controlled substance from one manufacturer to another, from manufacturer to wholesaler, and from wholesaler to dispenser. In the case of Schedule I and II drugs, the supplier must have a special order form from the customer. This order form (DEA Form 222) is issued by the DEA only to persons who are properly registered to handle Schedules I and II drugs. The form is preprinted with the name and address of the customer. The drugs must be shipped to this name and address. The use of this device is a special reinforcement of the registration requirement; it makes doubly certain that only authorized individuals may obtain Schedule I and II drugs. Another benefit of the form is the special monitoring it permits. The form is issued in triplicate: the customer must keep one copy for his or her own files; he or she forwards two copies to the supplier who, after filling the order, keeps a copy for his or her own records and forwards the third copy to the nearest DEA office.

For drugs in Schedules III, IV, and V, no order form is necessary. The supplier in each case, however, is under an obligation to verify the authenticity of his or her customer. The supplier is held fully accountable for any drugs that are shipped to a purchaser who does not have a valid registration.

Those registered as manufacturers and distributors in Schedule I, II, or III narcotics are also required to submit periodic reports to the DEA of their manufacturing and distribution transactions. They are also required to file annual inventories of the Schedule I, II, or III narcotic-controlled substances that they handle. This data is entered into a system called the Automated Reports and Consolidated Orders System (ARCOS). It enables the DEA to monitor the distribution of controlled substances throughout the country and to identify retail level registrants that receive unusual quantities of controlled substances.

Dispensing to Patients

The dispensing of a controlled substance is the delivery of the controlled substance to the ultimate user, who may be a patient or research subject. Special control mechanisms operate here as well. Schedule I

drugs are those that have no currently accepted medical use in the United States; they may, therefore, be used in the United States only in research situations. They generally are supplied by only a limited number of firms to properly registered and qualified researchers. Controlled substances may be dispensed by a practitioner by direct administration, by prescription, or by dispensing from office supplies. Records must be maintained by the practitioner of all dispensing of controlled substances from office supplies and of certain administrations. The FCSA does not require the practitioner to maintain copies of prescriptions, but certain states require the use of multiple copy prescriptions for Schedule II and other specified controlled substances.

Prescription Drugs

The determination to place drugs on prescription is within the jurisdiction of FDA. Unlike other prescription drugs, however, controlled substances are subject to additional restrictions. Schedule II prescription orders must be written and signed by the practitioner; they may not be telephoned into the pharmacy except in an emergency. In addition, a prescription for a Schedule II drug may not be refilled; the patient must see the physician again in order to obtain more drugs. For Schedule III and IV drugs the prescription order may be either written or oral (that is, by telephone to the pharmacy). In addition, the patient may (if authorized by the doctor) have the prescription refilled on his or her own up to five times and at anytime within 6 months from the date of the initial dispensing.

Schedule V includes some prescription drugs and many over-the-counter narcotic preparations, including antitussives and antidiarrheals. Even here, however, the law imposes restrictions beyond those normally required for the over-the-counter sales; for example, the patient must be at least 18 years of age, must offer some form of identification, and have his or her name entered into a special log maintained by the pharmacist as part of a special record.

SECURITY

DEA registrants are required by regulation to maintain certain security for the storage and distribution of controlled substances. Manufacturers and distributors of Schedule I and II substances must store controlled substances in specially constructed vaults or highly rated safes and maintain electronic security for all stor-

Table 7-3.—Federal Trafficking Penalties

FEDERAL TRAFFICKING PENALTIES																
SCHEDULE	DRUG	FIRST OFFENSE							SECOND OFFENSE							
		TRACE	5g	100g	500g	1kg	10kg	50kg or More	TRACE	5g	100g	500g	1kg	10kg	50kg or More	
I & II	LSD	[Hatched Area]	[Solid Black Area]							[Solid Black Area]						
	Narcotics*		MAXIMUM 20 YEARS \$250,000							MAXIMUM 40 YEARS \$500,000						
	PCP		[Solid Black Area]							[Solid Black Area]						
	Cocaine		[Solid Black Area]							[Solid Black Area]						
	Others**		MAXIMUM 15 YEARS \$125,000							MAXIMUM 30 YEARS \$250,000						
	Hash Oil		[Solid Black Area]							[Solid Black Area]						
	Hashish		[Solid Black Area]							[Solid Black Area]						
	Marijuana		MAXIMUM 5 YEARS \$50,000							MAXIMUM 10 YEARS \$100,000						
III	All	[Solid Black Area]							[Solid Black Area]							
IV	All	MAXIMUM 3 YEARS \$25,000							MAXIMUM 6 YEARS \$50,000							
V	All	MAXIMUM 1 YEAR \$10,000							MAXIMUM 2 YEARS \$20,000							

*Except coca leaves and derivatives.
**Others - some stimulants, some depressants and some hallucinogens.

age areas. Lesser physical security requirements apply to retail level registrants such as hospitals and pharmacies.

All registrants are required to make every effort to make sure controlled substances in their possession are not diverted into the illicit market. This requires operational as well as physical security. For example, registrants are responsible for making sure controlled substances are distributed only to other registrants who are authorized to receive them, or to legitimate patients and consumers.

PENALTIES

LEARNING OBJECTIVES: Identify the federal trafficking penalties for each schedule of drugs and the various types of marijuana. Explain the penalties provided in terms of quantity and first and second offenses.

The FCSA provides penalties for unlawful manufacturing, distribution, and dispensing of controlled

substances. The penalties are basically determined by the schedule of the drug or other substance, and sometimes are specified by drug name, as in the case of marijuana. As the statute has been amended since its initial passage in 1970, the penalties have been altered by Congress. The following tables are an overview of the penalties for trafficking or unlawful distribution of controlled substances. This is not inclusive of the penalties provided under the FCSA. See tables 7-3 and 7-4.

DRUG CHARACTERISTICS

LEARNING OBJECTIVES: Describe the uses and effects of six categories of controlled substances. Describe deliriant, designer drugs, and look-alike drugs.

For this chapter, we will place drugs into six categories—narcotics, depressants, stimulants, hallucinogens, cannabis, and steroids. These

Table 7-4.-Federal Trafficking Penalties-Marijuana

QUANTITY	DESCRIPTION	FIRST OFFENSE	SECOND OFFENSE
1,000 kg or more; or 1,000 or more plants	Marijuana Mixture containing detectable quantity *	Not less than 10 years, not more than life. If death or serious injury, not less than 20 years, not more than life. Fine not more than \$4 million individual, \$10 million other than individual.	Not less than 20 years, not more than life. If death or serious injury, not less than life. Fine not more than \$8 million individual, \$20 million other than individual.
100 kg to 1,000 kg; or 100 - 999 plants	Marijuana Mixture containing detectable quantity *	Not less than 5 years, not more than 40 years. If death or serious injury, not less than 20 years, not more than life. Fine not more than \$2 million individual, \$5 million other than individual.	Not less than 10 years, not more than life. If death or serious injury, not less than life. Fine not more than \$4 million individual, \$10 million other than individual.
50 to 100 kg 10 to 100 kg 1 to 100 kg 50 - 99 plants	Marijuana Hashish Hashish Oil Marijuana	Not more than 20 years. If death or serious injury, not less than 20 years, not more than life. Fine \$1 million individual, \$5 million other than individual.	Not more than 30 years. If death or serious injury, life. Fine \$2 million individual, \$10 million other than individual.
Less than 50 kg Less than 10 kg Less than 1 kg	Marijuana Hashish Hashish Oil	Not more than 5 years. Fine not more than \$250,000, \$1 million other than individual.	Not more than 10 years. Fine \$500,000 individual, \$2 million other than individual.

* Includes Hashish and Hashish Oil

(Marijuana is a Schedule 1 Controlled Substance)

controlled substances, their uses and effects, are outlined in table 7-5.

The MA attempting to identify capsules, tablets, and pills should consult the Product section of the *Physicians Desk Reference* (PDR). The PDR is a medical reference book published by the Medical Economics Company. Every MA unit should have a copy within the organization. The PDR contains true color pictures of most all legally manufactured drugs. If the MA has a capsule, tablet, or pill to identify, it may be easily and accurately compared to the photos in the PDR. The MA should bear in mind that if a capsule is being compared, the contents of that capsule may have been replaced and contain a substance other than that supplied by the manufacturer. Similarly, tablets and pills are often impregnated or "laced" with other drugs or substances by drug abusers. For this reason all pills, tablets, and capsules should be field tested.

The MA may obtain a copy of the PDR in several ways. The most common method is by obtaining a preceding year's copy from a local physician when the physician receives the current edition. Navy hospitals,

normal supply channels, and the Naval Criminal Investigative Service (NCIS) are alternate sources.

NARCOTICS

The term *narcotic* is used to describe opium, opium-based derivatives, and synthetic substitutes. The stimulant cocaine is a narcotic by legal definition. Narcotics have been useful in the practice of medicine for relief of intense pain, since they are the most effective analgesics known. The relief they provide may be physical or psychic.

Under medical supervision, narcotics are administered orally or by intramuscular injection. As drugs of abuse, however, they may be sniffed, smoked, or self-administered by the more direct routes of subcutaneous ("skin-popping") and intravenous ("mainlining") injection.

The relief of suffering, whether of physical or psychological origin, may result in a short-lived state of euphoria. The initial effects, however, are often unpleasant, leading many to conclude that those who persist in their illicit use may have latent personality

Table 7-5.—Controlled Substances; Uses and Effects

DRUGS	SCHEDULES CSA	TRADE OR OTHER NAMES	MEDICAL USES	PHYSICAL DEPENDENCE	PSYCHOLOGICAL DEPENDENCE	TOLERANCE	DURATION (Hours)	USUAL METHOD OF ADMINISTRATION	EFFECTS OF OVERDOSE	EFFECTS OF WITHDRAWAL SYNDROME	
											DRUGS
NARCOTICS											
HEROIN	I	Diacetylmorphine, Horse, Smack	None in U.S., Analgesic, Antitussive	High	High	Yes	3-6	Injected, Sniffed, Smoked	Euphoria, Drowsiness, Respiratory Depression, Constricted Pupils, Nausea	Slow & Shallow Breathing, Clammy Skin, Convulsions, Coma, Possible Death	Watery eyes, Runny Nose, Yawning, Loss of Appetite, Irritability, Tremors, Panic, Cramps, Nausea, Chills & Sweating
MORPHINE	II	Duromorph, MS-Contin, Roxanol, Oramorph SR	Analgesic	High	High	Yes	3-6	Oral, Smoked, Injected			
CODEINE	II, III, V	Tylenol w/Codeine, Empirin w/Codeine, Robiussin AC, Formin w/Codeine, APAP w/Codeine	Analgesic, Antitussive	Moderate	Moderate	Yes	3-6	Oral, Injected			
HYDROMORPHONE	II, III	Tussionex, Vicodin, Hycodan, Lorcet	Analgesic, Antitussive	High	High	Yes	3-6	Oral, Injected			
OXYCODONE	II	Percodan, Percocet, Tylox, Roxicet, Roxiprone	Analgesic	High	High	Yes	3-6	Oral			
METHADONE & LAAM	I, II	Deponine, Methadone, Levo-alpha-acetylmethadol, Levomethadylacetate	Analgesic, Treatment of Dependence	High	High	Yes	12-72	Oral, Injected			
FENYANYL & ANALOGS	I, II	Inoral, Sublimaze, Alfenta, Sufenta, Duragesic	Analgesic, Adjunct to Anesthesia, Anesthetic	High	High	Yes	10-72	Injected, Transdermal Patch			
OTHER NARCOTICS	II, III, IV, V	Percodan, Percocet, Tylox, Opium, Duron, Telnor-2, Buprenorphine, Meperidine (Pethidine), Demorol	Analgesic, Antidiarrheal	High-Low	High-Low	Yes	Variable	Oral, Injected			
DEPRESSANTS											
CHLORAL HYDRATE	IV	Noctec, Somnos, Falsules	Hypnotic	Moderate	Moderate	Yes	5-8	Oral	Slurred Speech, Disorientation, Drunken Behavior without Odor of Alcohol	Shallow Respiration, Clammy Skin, Dilated Pupils, Weak & Rapid Pulse, Coma, Possible Death	Anxiety, Insomnia, Tremors, Delirium, Convulsions, Possible Death
BARBITURATES	II, III, IV	Anytal, Fiorinal, Nembutal, Seconal, Tuinal, Phenobarbital, Pentobarbital	Hypnotic, Anesthetic, Sedative, Hypnotic, Veterinary Euthanasia Agent	High-Mod.	High-Mod.	Yes	1-16	Oral, Injected			
BENZODIAZEPINES	IV	Ativan, Dalmane, Diazepam, Librium, Xanax, Serax, Valium, Tranxene, Valtran, Versed, Halcion, Paxipam, Restoril	Antianxiety, Sedative, Anticonvulsant, Hypnotic	Low	Low	Yes	4-8	Oral, Injected			
GLUTETHIMIDE	II	Doriden	Sedative, Hypnotic	High	Moderate	Yes	4-8	Oral			
OTHER DEPRESSANTS	I, II, III, IV	Equanil, Miltown, Noludar, Placidyl, Valmid, Methaqualone	Antianxiety, Sedative, Hypnotic	Moderate	Moderate	Yes	4-8	Oral			
STIMULANTS											
COCAINE ¹	II	Coke, Flake, Snow, Crack	Local Anesthetic	Possible	High	Yes	1-2	Sniffed, Smoked, Injected	Increased Alertness, Excitation, Euphoria, Increased Pulse Rate & Blood Pressure, Insomnia, Loss of Appetite	Agitation, Increased Body Temperature, Hallucinations, Convulsions, Possible Death	Apathy, Long Sleep, Irritability, Depression, Disorientation
AMPHETAMINE/METHAMPHETAMINE	II	Biphetamine, Desoxy, Dexedrine, Osetrol, Ice	Attention Deficit Disorder, Narcicapsy, Weight Control	Possible	High	Yes	2-4	Oral, Injected, Smoked			
METHYLPHENIDATE	II	Ritalin	Attention Deficit Disorder, Narcicapsy	Possible	High	Yes	2-4	Oral, Injected			
OTHER STIMULANTS	I, II, III, IV	Adipax, Didax, Isamin, Mefrat, Plegine, Captagon, Sarovak, Tenuate, Tepanil, Phelc-2, Preludin	Weight Control	Possible	High	Yes	2-4	Oral, Injected			
HALLUCINOGENS											
LSD	I	Acid, Microdot	None	None	Unknown	Yes	8-12	Oral	Illusions & Hallucinations, Altered Perception of Time & Distance	Longer, More Intense "Trip" Episodes, Psychosis, Possible Death	Unknown
MESCALINE & PEYOTE	I	Mescal, Buttons, Cactus	None	None	Unknown	Yes	8-12	Oral			
AMPHETAMINE VARIANTS 2	I	5-DMA, STP, MDA, MDMA, Ecstasy, DOM, DOB	None	Unknown	Unknown	Yes	Variable	Oral, Injected			
PHENCYCLIDINE & ANALOGS	I, II	PCP, PCPY, TOP, POP, Hog, Loveboat, Angel Dust	None	Unknown	High	Yes	Days	Oral, Smoked			
OTHER HALLUCINOGENS	I	Bufotenine, Ibogaine, DMT, DET, Psilocybin, Psilocyn	None	None	Unknown	Possible	Variable	Smoked, Oral, Injected, Sniffed			
CANNABIS											
MARLUANA	I	Pot, Acapulco Gold, Grass, Reefer, Sinsemilla, Thai Sticks	None	Unknown	Moderate	Yes	2-4	Smoked, Oral	Euphoria, Relaxed Inhibitions, Increased Appetite, Disorientation	Fatigue, Paranoia, Possible Psychosis	Occasional Reports of Insomnia, Hyperactivity, Decreased Appetite
TETRAHYDROCANNABINOL	I, II	THC, Marinol	Antinauseant	Unknown	Moderate	Yes	2-4	Smoked, Oral			
HASHISH & HASHISH OIL	I	Hash, Hash Oil	None	Unknown	Moderate	Yes	2-4	Smoked, Oral			
ANABOLIC STEROIDS											
TESTOSTERONE (Cypionate, Enanthate)	III	Depo-Testosterone, Delatestyl	Hypogonadism	Unknown	Unknown	Unknown	14-28 Days	Injected	Virilization, Acne, Testicular Atrophy, Gynecomastia, Aggressive Behavior, Edema	Unknown	Possible Depression
NANDROLONE (Decanoate, Phenpropionate)	III	Nortestosterone, Durabolin, Deca, Deca-Durabolin	Anemia, Breast Cancer	Unknown	Unknown	Unknown	14-21 Days	Injected			
OXYMETHOLONE	III	Anadrol-50	Anemia	Unknown	Unknown	Unknown	Unknown	Oral			

1. Designated a narcotic under the CSA.

2. Not designated a narcotic under the CSA.

disturbances. Narcotics tend to induce pinpoint pupils and reduced vision, together with drowsiness, apathy, decreased physical activity, and constipation. A larger dose may induce sleep, but there is an increasing possibility of nausea, vomiting, and respiratory depression—the major toxic effect of the opiates. Except in cases of acute intoxication, there is no loss of motor coordination or slurred speech as in the case of the depressants.

To the extent that the response may be felt to be pleasurable, its intensity may be expected to increase with the amount of the dose administered. Repeated use, however, will result in increasing tolerance. The user must administer progressively larger doses to attain the desired effect, thereby reinforcing the compulsive behavior known as drug dependence.

Physical dependence refers to an alteration of the normal functions of the body that necessitates the continued presence of a drug to prevent the withdrawal or abstinence syndrome, which is characteristic of each class of addictive drug. The intensity of physical symptoms experienced during the withdrawal period is related directly to the amount of narcotic used each day. Deprivation of an addictive drug causes increased excitability of those same bodily functions that have been depressed by its habitual use.

With the deprivation of narcotics, the first withdrawal signs are usually experienced shortly before the time of the next scheduled dose. Complaints, pleas, and demands by the addict are prominent, increasing in intensity and peaking from 36 to 72 hours after the last dose, then gradually subsiding. Symptoms such as watery eyes, runny nose, yawning, and perspiration appear about 8 to 12 hours after the last dose. Thereafter, the addict may fall into a restless sleep. As the abstinence syndrome progresses, restlessness, irritability, loss of appetite, insomnia, goose flesh, tremors, and finally yawning and severe sneezing occur. These symptoms reach their peak at 48 to 72 hours. The patient is weak and depressed with nausea and vomiting. Stomach cramps and diarrhea are common. Heart rate and blood pressure are elevated. Chills alternating with flushing and excessive sweating are also characteristic symptoms. Pains in the bones and muscles of the back and extremities occur as do muscle spasms and kicking movements, which may be the source of the expression “kicking the habit.” At this time, some persons may become suicidal. Without treatment, the syndrome eventually runs its course and most of the

symptoms will disappear in 7 to 10 days. However, the psychological desire for the drug may never be overcome.

Since addicts tend to become preoccupied with the daily round of obtaining and taking drugs, they often neglect themselves and may suffer from malnutrition, infections, and unattended diseases or injuries. Among the hazards of narcotic addiction are toxic reactions to contaminants such as quinine, sugars, and talcum powder, as well as unsterile needles and injection techniques, resulting in abscesses, blood poisoning, and hepatitis. Since there is no simple way to determine the purity of a drug that is sold on the street, the potency is unpredictable. A person with a mild overdose may be stuporous or asleep. Larger doses may induce a coma with slow shallow respiration. The skin becomes clammy cold, the body limp, and the jaw relaxed. There is a danger that the tongue may fall back, blocking the air passageway. If the condition is sufficiently severe, convulsions may occur, followed by respiratory arrest and death.

Narcotics of Natural Origin

The poppy (*papaver somniferum*) (fig. 7-1) is the main source of the nonsynthetic narcotics. It was grown in the Mediterranean region as early as 300 B.C. and has since been cultivated in countries around the world, including Hungary, Yugoslavia, Turkey, India, Burma, China, and Mexico.

The milky fluid that oozes from incisions in the unripe seedpod (fig. 7-2) has since ancient times been scraped by hand and air dried to produce opium gum

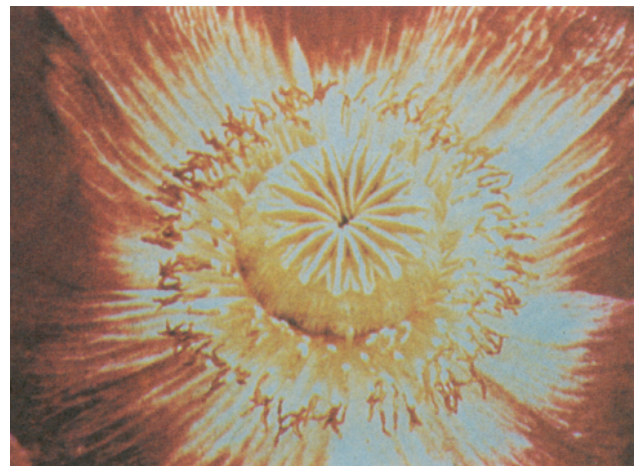

C193.281

Figure 7-1.—The poppy (*papaver somniferum*).



C193.282

Figure 7-2.—The milky fluid from incisions in the unripe seedpod.



C193.283

Figure 7-3.—Fluid scraped by hand and air dried to produce opium gum.

(fig. 7-3). A more modern method of harvesting is by the industrial poppy straw process of extracting alkaloids from the mature dried plant. The extract may be in liquid, solid, or powder form. Most poppy straw concentrate made available commercially is a fine brownish powder with a distinct odor.

OPIUM.—Raw opium (fig. 7-4) has a distinctive and pungent odor. It is most commonly used by smoking in long-stemmed pipes. The user presents a sleepy and relaxed appearance while under the influence of the drug. There is little abuse of opium in the United States.



C193.284

Figure 7-4.—Opium.

At least 25 alkaloids can be extracted from opium. These fall into two general categories, each producing markedly different effects. The first category, known as the *phenanthrene* alkaloids and represented by morphine and codeine, is used as analgesics and cough suppressants; the second category, the *isoquinoline* alkaloids, represented by papaverine (an intestinal relaxant) and noscapine (a cough suppressant), has no significant influence on the central nervous system and is not regulated under the FCSA.

Although a small amount of opium is used to make antidiarrheal preparations, such as paregoric, virtually all the opium imported into this country is broken down into its alkaloid constituents, principally morphine and codeine.

Opium can create both mental and physical dependence in the user, and chronic use will result in both symptoms being manifested. Raw opium is the source of morphine, heroin, codeine, paregoric, and other derivatives.

MORPHINE.—Morphine is obtained from a raw opium base through a chemical process. Ten pounds of raw opium is required to yield 1 pound of morphine base, which is then converted on a 1 to 1 ratio to morphine. Ranging in concentration from 4 to 21 percent, morphine is one of the most effective drugs known for the relief of pain.

Morphine usually appears as a white crystalline powder on the illicit market, but also appears in tablet, capsule, and liquid form (fig. 7-5). Morphine is odorless, tastes bitter, and darkens with age.

Morphine is usually administered by injection with the hypodermic syringe (or hypodermic needle and medicine dropper combination) and can create both mental and physical dependence in the user. Tolerance and dependence develop rapidly in the user. A euphoric state is obtained with morphine, and the chronic user presents a sleepy or relaxed appearance and may exhibit constricted pupils of the eyes.

Only a small part of the morphine obtained from opium is used medically. Most of it is converted to codeine and, secondarily, to hydromorphone.

CODEINE.—Codeine is another derivative of opium. It appears on the market in tablet, capsule, and liquid form, and can be administered orally or by injection. It ranges in concentrations of 0.7 to 2.5 percent.



Figure 7-5.—Various forms of morphine.

C193.285

Codeine can create both mental and physical dependence in the abuser, but is milder in effect than morphine or heroin. It is prescribed extensively in medicine and is the base of many pain relievers and cough remedies. Codeine is normally used by drug abusers when more powerful opiates are not available. It is found in opium, but produced from morphine.

THEBAINE.—Although it is chemically close to codeine and morphine, thebaine produces a stimulant rather than a depressant effect. Thebaine is not used in the United States for medical purposes, but it is converted into a variety of medically important compounds, including codeine, hydrocodone, oxycodone, oxymorphone, nalbuphine, naloxone, and the Bentley compounds. It is controlled in the Schedule II of the FCSA as well as under international law.

Semisynthetic Narcotics

The following narcotics are among the more significant synthetic substances that have been derived by modification of the chemicals contained in opium.

HEROIN.—Heroin (diacetylmorphine) like morphine usually appears as a crystalline white powder and may be sold illegally in glassine, aluminum foil packets, or in capsules. It may be a brownish color (Mexican) (fig. 7-6) or in the form of small chunks, called rock, which may be red or purplish. Dark heroin usually contains more impurities. Heroin has no odor or taste, and any odor or taste noted is that of the diluent used to “cut” the heroin.

Heroin in its pure form (Southwest Asian) (fig. 7-7) is about four to five times stronger than morphine and is normally the drug addict’s choice among drugs that cause physical dependence because of its durability of action whatever the percentage of dose. Pure heroin is rarely sold on the street.

Methods of use and effects of heroin are similar to those of morphine to include mental and physical dependence. A lethargic, drowsy, “on-the-nod” physical state can be expected as a result of the dose of heroin. Inhaling heroin causes redness and rawness around the nostrils due to an acid content in the substance.

Heroin is the most commonly injected narcotic. Normally, narcotic abusers do not start their needle habit by injecting directly into a vein, but begin with

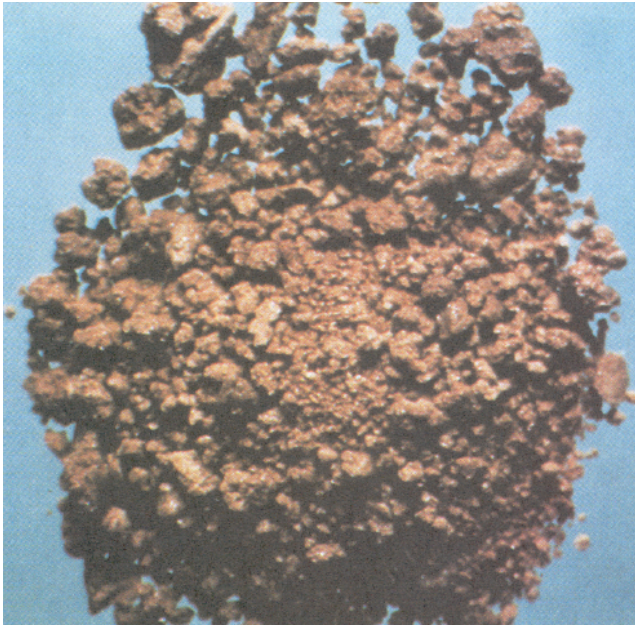

C193.286

Figure 7-6.—Mexican heroin.



C193.287

Figure 7-7.—Southwest Asian heroin.

intra-dermal injections, or scratchings just under the skin. Skin popping, or subcutaneous injection, refers to entry of the needle beneath the skin's surface. An intramuscular injection goes into the muscle and flesh of the body. Finally, intravenous injection directly

into the bloodstream by piercing the vein will bring on the quickest reaction to the drug. (Injecting heroin leaves visible scars or "track marks" that are usually found in the inner surface of the arms and elbows. Some heroin users may inject into the body where needle marks may not be seen, such as between the toes or behind the knees or under the tongue.)

A syringe, bent spoon or bottle cap, eye or medicine dropper, matches, cotton, a nail or bent razor blade, a belt or tie, and needles are all items that can be found in or as part of a kit used to prepare and administer heroin. Heroin is also placed in cigarettes and smoked.

Heroin sold on the streets is diluted compared to the heroin as it initially enters this country. For instance, heroin coming from Europe in most cases is over 90 percent pure. By the time it is cut or adulterated with milk, sugar, quinine, procaine, mannitol, and so on, the average street dose probably contains no greater than 10 percent heroin.

To increase the bulk of the material sold to the addict, diluents are mixed with the heroin in ratios of from 9 to 1 to much as 99 to 1. The substances used to cut heroin are used because they are like heroin in color; they readily dissolve in water with the heroin when the user prepares for a dose or a "fix," and they stretch the supplier's heroin for greater profits. A "bag"—slang for a single dosage unit of heroin—may weigh about 100 milligram (mg), and usually contains 5 percent heroin.

BLACK TAR HEROIN.—Black tar heroin has also become increasingly available in recent years, especially in the western United States. Black tar heroin is a crudely processed form of heroin illicitly manufactured in Mexico. It may be sticky like roofing tar or hard like coal, and it is dark brown to black in color. Black tar heroin is often sold on the street in its tarlike state, sometimes at purities ranging as high as 40 to 80 percent. Black tar heroin is sometimes diluted. However, by adding materials of similar consistency, such as burnt cornstarch, or by converting the tar heroin into a powder and adding conventional diluents, such as mannitol or quinine, it is most commonly used through injection.

HYDROMORPHONE.—Most commonly known as dilaudid, hydromorphone is the second oldest semisynthetic narcotic analgesic. Marketed both in tablet and injectable form, it is shorter acting and more sedative than morphine, but its potency is from two to eight times as great. It is, therefore, a

highly abusable drug, much sought after by narcotic addicts who usually obtain it through fraudulent prescription or theft. The tablets, stronger than available liquid forms, may be dissolved and injected.

OXYCODONE.— Oxycodone is synthesized from thebaine. It is similar to codeine, but more potent and with a higher dependence potential. It is effective orally and is marketed in combination with other drugs such as Percodan for the relief of pain. Addicts take Percodan orally or dissolve tablets in water, filter out the insoluble material, and “mainline” the active drug.

PAREGORIC.— Paregoric is a camphorated tincture of opium usually taken for the relief of diarrhea and intestinal pain.

Synthetic Narcotics

In contrast to pharmaceutical products derived directly or indirectly from narcotics of natural origin, synthetic narcotics are produced entirely within the laboratory. A continuing search for a product that will retain the analgesic properties of morphine, without the consequent dangers of tolerance and dependence, has yet to yield a drug that is not susceptible to abuse. The two that are most widely available synthetics are meperidine and methadone. We will also discuss the fentanyls, which are a large class of synthetic opiates.

MEPERIDINE (pethidine).— The first synthetic narcotic, produced originally a generation ago, meperidine is chemically dissimilar to morphine but resembles it in its analgesic potency. It is probably the most widely used drug for the relief of moderate to severe pain. Available in pure form as well as in products containing other medicinal ingredients, it is administered either orally or by injection, the latter method being the most widely abused. Tolerance and dependence develop with chronic use, and large doses can result in convulsions. Demerol is a commercial name for pethidine.

METHADONE AND RELATED DRUGS.— Methadone is widely used in the treatment of narcotic addicts. The effects of methadone differ from morphine-based drugs in that they have a longer duration of action, lasting up to 24 hours, thereby permitting administration only once a day in heroin detoxification and maintenance programs. Moreover, methadone is almost as effective when administered orally as it is by injection. But tolerance and dependence may develop, and withdrawal symptoms, though they develop more slowly and are less severe, are more prolonged. Ironically, methadone, designed

to control narcotic addiction, has emerged in some metropolitan areas as a major cause of overdose deaths.

Closely related chemically to methadone is the synthetic compound levo-alpha-acetylmethadol (LAAM), which has an even longer duration of action (from 48 to 72 hours), permitting a further reduction in clinic visits and the elimination of take-home medication. Recently, LAAM has been approved for the treatment of narcotic addicts by the Federal Food and Drug Administration.

Another close relative of methadone is propoxyphene, first marketed in 1957 under the trade name of Darvon for the relief of mild to moderate pain. Less dependence-producing than the opiates, it is also less effective as an analgesic.

Fentanyl Analogues

The fentanyls represent a large class of synthetic opiates having powerful analgesic and anesthetic effects. They act via mechanisms similar to that of morphine. The prototypical drug in this class is fentanyl which has a clinical potency of 50 to 100 times that of morphine. Certain members of this class have important application in human and veterinary medicine. Other substances within this class are of interest primarily because of their clandestine synthesis and subsequent abuse on the street.

In the United States four fentanyls are approved for marketing. These drugs include fentanyl citrate itself, alfentanil hydrochloride, sufentanil citrate, and carfentanil citrate. The first three drugs are approved for use in human medical practice. The fourth, carfentanil citrate, is approved for use in veterinary medicine. Fentanyl, alfentanil, sufentanil and carfentanil are all considered to have a high abuse potential and are in Schedule II of the FCSA.

Of the four drugs, only fentanyl has been clandestinely synthesized and abused out on the street using common, commercially available chemicals and simple laboratory equipment. The biological effects of the fentanyls are indistinguishable from those of heroin with the exception that the fentanyls may be hundreds of times more potent. There are hundreds of fentanyl analogues, with each differing only in potency and duration of action. The high potency, thence low dosage required for producing effect, and the multiplicity of active, structural analogues possible, make it difficult to detect the fentanyls in the illicit traffic. To date, over 12 different clandestinely

produced fentanyl analogues have been identified in the U.S. illicit drug traffic. Over 100 deaths have been attributed to the abuse of these drugs. Although the clandestine synthesis, distribution, and abuse of the fentanyls have been confined to the United States up to this time, their extremely high potency and relative ease of synthesis make them serious drug abuse threats internationally.

PHARMACOLOGICAL EFFECTS.— Fentanyls produce pharmacological effects characteristic of opiates. They produce all the effects of heroin including analgesia, euphoria, pinpoint pupils, and respiratory depression. Due to their high lipid solubility, fentanyls, regardless of route of administration, reach the brain quickly, thus providing for a very fast onset of action. The fast onset of action is considered a highly desirable trait by heroin users. Fentanyl users report experiencing the first desirable trait by heroin users. Fentanyl users report experiencing the first effects within 90 seconds after intravenous administration and by 2 minutes they are in a relaxed, euphoric state. In nontolerant individuals, spontaneous breathing can stop at this time, and overdose deaths are likely to occur very rapidly with these drugs.

The duration of the pharmacological effects will vary depending upon the fentanyl analogue used. Opiatelike effects can persist for as little as 5 minutes, as in the case with alfentanil, or last for one-half hour as in the case for fentanyl. 3-methylfentanyl has a duration of action of about 4 hours which is similar to that of heroin.

CHARACTERISTICS OF FENTANYLS.— The fentanyls are most commonly taken by intravenous administration, but like heroin, they may be smoked or snorted. In fact, some users prefer the intranasal route and there are reports that the drugs are available in two forms—one for shooters and one for snorters. Illicit fentanyls are generally diluted (cut) with very large amounts of lactose or mannitol and occasionally are mixed with cocaine or heroin. Because street samples contain only a small amount of active drug, generally less than 1 percent, they do not usually have a distinctive color, odor, or taste. The color of fentanyl samples may range from pure white (in which case it may be sold as Persian white) to an off-white or light tan (sold as China white, synthetic heroin, or fentanyl), to light or dark brown (sold as Mexican brown). The brown color is thought to come from lactose that has been heated until it becomes slightly caramelized. Similarly, the texture of the samples may range from light and finely powdered to

somewhat coarse, cakelike and crumbly, resembling powdered milk. Occasionally, fentanyl samples may have a medicinal or chemical odor, but this is not characteristic. There is nothing about the appearance of fentanyl samples that is unique, and it is impossible to distinguish them from heroin except by chemical analysis.

EFFECTS OF FENTANYLS.— Fentanyls produce all the effects and side effects of the classical narcotic analgesics. They are among the most potent respiratory depressants and analgesics discovered to date and can produce profound pain relief at remarkably low doses. Other effects include euphoria, pinpoint pupils, nausea, and an increase in muscle tone commonly called wooden chest or lead-pipe rigidity. A transient drop in heart rate and blood pressure, effects not usually found with heroin use, are observed in surgical patients receiving fentanyls. Respiratory depression and coma are the most serious adverse effects of the fentanyls. Fentanyl plasma levels above 2 to 3 rig/ml are associated with respiratory depression which may be life-threatening.

Chronic use of fentanyls does not typically produce any damage to organs or tissues. Bacterial and viral infections may develop from the use of infected needles. When used regularly, the fentanyls produce narcoticlike tolerance and physiological dependence. Experienced heroin users report that the effects of fentanyls are similar to, and are an acceptable substitute for, heroin. Fentanyls thus appear to have an abuse liability equivalent to heroin.

Respiratory depression is the most serious toxic effect of the fentanyls. This can be quickly and effectively reversed by naloxone (Narcan). Naloxone is a specific opiate antagonist and is the antidote of choice; however, because the fentanyls are so extraordinarily potent, higher doses than are normally used may be required (for example, milligrams rather than micrograms). Naloxon must be administered quickly, because life-threatening respiratory depression occurs within minutes after administration of the fentanyls. Repeated naloxon administration may be necessary when dealing with a long-acting fentanyl analogue.

DEPRESSANTS

Substances regulated under the FCSA as depressants have a high potential for abuse associated with both physical and psychological dependence.

Taken as prescribed by a physician, depressants may be beneficial for the relief of anxiety, irritability, and tension, and for the symptomatic treatment of insomnia. In excessive amounts, however, they produce a state of intoxication that is remarkably similar to that of alcohol.

As in the case of alcohol, these effects may vary not only from person to person but from time to time in the same individual. Low doses produce mild sedation. Higher doses, insofar as they relieve anxiety or stress, may produce a temporary sense of well-being. They may also produce mood depression and apathy. In marked contrast to the effects of narcotics, however, intoxicating doses invariably result in impaired judgment, slurred speech, and loss of motor coordination.

Tolerance to the intoxicating effects develops rapidly, leading to a progressive narrowing of the margin of safety between an intoxicating and lethal dose. The person who is unaware of the dangers of increasing dependence will often increase the daily dose up to 10 to 20 times the recommended therapeutic level. The source of supply maybe no further than the family medicine cabinet. Depressants are frequently obtained by theft, illegal prescription, or purchase on the illicit market.

Members of the drug subculture often resort to the use of depressants as self-medication to soothe jangled nerves brought on by the use of stimulants, to quell the anxiety of “flashbacks” resulting from prior use to hallucinogens, or to ease their withdrawal from heroin. The dangers are compounded when depressants are used in combination with alcohol or other drugs. Chronic intoxication, though it affects every age group, is most common in middle age.

Depressants vary with respect to their potential for overdose. Moderate depressant poisoning closely resembles alcoholic inebriation. The symptoms of severe depressant poisoning are coma, cold clammy skin, a weak and rapid pulse, and slow or rapid, but shallow, respiration. Death will follow if the reduced respiration and low blood pressure are not counteracted by proper medical treatment.

Among the depressants that give rise to the general conditions described are a broad array of barbiturates, glutethimide, meprobamate, and the benzodiazepines.

Barbiturates

Among the drugs most frequently prescribed by both physicians and veterinarians to induce sedation and sleep are the barbiturates. About 2,500 derivatives of barbituric acid have been synthesized, but of these only about 15 remain in medical use. Small therapeutic doses tend to calm nervous conditions, and larger doses cause sleep 20 to 60 minutes after oral administration. As in the case of alcohol, some individuals may experience a sense of excitement before sedation takes effect. If dosage is increased, however, the effects of the barbiturates may progress through successive stages of sedation, sleep, and coma to death.

Barbiturates are often referred to as “sleepers” or “downers” because of their depressant and sleep-producing effects on the central nervous system. The effects and symptoms of barbiturate use resemble intoxication associated with alcohol except that there is no odor on the breath.

Barbiturates are classified as ultrashort, short, intermediate, and long-acting. The ultrashort-acting barbiturates produce anesthesia within 1 minute after intravenous administration. The rapid onset and brief duration of action make them undesirable for purposes of abuse.

Among the short-acting and intermediate-acting barbiturates are pentobarbital (Nembutal), secobarbital (Seconal), and amobarbital (Amytal)—three of the drugs in the depressant category most sought after by abusers. The group also includes butobarbital (Butisol), butalbital (Lotusate), allobarbital (Dial), aprobarbital (Alurate), and vinbarbital (Delvinal). After oral administration, the onset time of action is from 15 to 40 minutes and duration of action is up to 6 hours.

Long-acting barbiturates, which include barbital (Veronal), phenobarbital (Luminal), mephobarbital or methylphenobarbital (Mebaral), and metharbital (Gemonil), have onset times of up to 1 hour and durations of action up to 16 hours. Their slow onset of action discourages their use for episodic intoxication, and they are not ordinarily distributed on the illicit market except when sold as something else.

Barbiturates are capable of depressing or inhibiting the normal activity of nerves and muscles. Under medical supervision, barbiturates are safe and effective, but when they are abused in large amounts,

they can be very dangerous because tolerance and physical and mental dependence develop.

Barbiturates appear as tablets, powders, capsules, and in injection and liquid form; but are most often taken orally in tablets or capsules. Barbiturates appear in a variety of colors due to the manner in which they are packaged and marketed. The more popular tablets and capsules are usually called by their slang names referring to their color; for example:

Pentobarbital and Nembutal are called “yellow jackets.”

Seconal and secobarbital are referred to as “reds,” “red devils,” “red birds,” or “pinks.”

Amobarbital tablets and capsules are called “blue birds,” “blue devils,” or “blue heavens.”

Tuinal, a mixture of amobarbital and secobarbital, is called “rainbows,” “double trouble,” or “red and blues.”

Most barbiturates are manufactured legitimately in massive quantities by pharmaceutical firms. They reach the illicit market by diversion and theft, by bogus prescriptions, or by poor control by the manufacturer. Some barbiturates are manufactured by clandestine laboratories for distribution on the illicit market.

Glutethimide

When glutethimide (Doriden) was introduced in 1954, it was said to be a safe barbiturate substitute without an addiction potential. But experience has shown that glutethimide has no particular advantage over the barbiturates and has several important disadvantages. Because the effects of this drug are of long duration, it is exceptionally, difficult to reverse overdoses that often result in death.

Meprobamate

Meprobamate, first synthesized in 1950, introduced the era of mild or “minor” tranquilizers. In the United States today more than 200 tons of meprobamate are distributed annually under its generic name as well as under brand names such as Miltown, Equanil, Kesso-Bamate, and SK-Bamate. Meprobamate is prescribed primarily for the relief of anxiety, tension, and associated muscle spasms. Its onset and duration of action are like those of the intermediate-acting barbiturates. It differs from them in that it is a muscle relaxant, does not produce sleep

at therapeutic doses, and is relatively less toxic. Excessive use, however, can result in psychological and physical dependence. Mebutamate (Dormate), a drug similar to meprobamate in its chemical makeup and effects, is also regulated under the FCSA.

Benzodiazepines

These substances are marketed as mild or minor tranquilizers, sedatives, hypnotics, or anticonvulsants. Their margin of safety is greater than that of other depressants. Fifteen members of the group are currently marketed in the United States. They are alprazolam (Xanax), chlordiazepoxide (Librium), clonazepam (Klonopin), clorazepate (Tranxene, Azene), diazepam (Valium), estazolam (Prosom), flurazepam (Dalmane), halazepam, lorazepam (Ativan), midazolam, oxazepam (Serax), prazepam (Verstran), quazepam (Doral), temazepam (Restoril), and triazolam (Halcion).

Prolong use of therapeutic or excessive doses may result in physical and psychological dependence. These drugs are also used by people in methadone maintenance programs in combination with narcotics such as methadone to obtain a “high.”

STIMULANTS

The two most prevalent stimulants are nicotine in tobacco products, and caffeine, the active ingredient of coffee, tea, and some beverages sold in every supermarket. These two stimulants, even when used in moderation, have a dependence-producing potential. These stimulants tend to relieve fatigue and increase alertness, and they are an accepted part of our culture.

There are, however, more potent stimulants that, because of their dependence-producing potential, are under the regulatory control of the FCSA. Some of these controlled stimulants, such as amphetamine, methamphetamine, methylphenidate, and cocaine, are available on prescription for medical purposes. They are also clandestinely manufactured in vast quantities for distribution on the illicit market.

Users tend to rely on stimulants to feel stronger, more decisive, and self-possessed. Because of the cumulative effects of the drugs, chronic users often follow a pattern of taking uppers in the morning and downers such as alcohol or sleeping pills at night. Such chemical manipulation interferes with normal

body processes and can lead to mental and physical illness.

Young people who resort to stimulants for their euphoric effects consume large doses sporadically, over weekends or at night, often going on to experiment with other drugs of abuse. In contrast, some people go on a drug binge lasting from 2 to 8 days, administering drugs over and over without sleeping or eating.

The consumption of stimulants may result in a temporary sense of exhilaration, superabundant energy, hyperactivity, extended wakefulness, and a loss of appetite. It may also induce irritability, anxiety, and apprehension. These effects are greatly intensified with administration by intravenous injection, which may produce a sudden sensation known as a “flash” or “rush.” The protracted use of stimulants is followed, however, by a period of depression known as “crashing” that is invariably described as unpleasant. Since the depression can be easily counteracted by an injection of stimulant, this abuse pattern becomes increasingly difficult to break. Heavy users may inject themselves every few hours, a process sometimes continued to the point of delirium, psychosis, or physical exhaustion.

Tolerance develops rapidly to both the euphoric and appetite suppressant effects.

If withdrawn from stimulants, chronic high-dose users exhibit profound depression, apathy, fatigue, and disturbed sleep for up to 20 hours a day. The immediate withdrawal syndrome may last for several days. There may also be a lingering impairment of perception and thought processes. Anxiety, an incapacitating tenseness, and suicidal tendencies may persist for weeks or months. Many experts now interpret these symptoms as indicating that stimulant drugs are capable of producing physical dependence. Whether the withdrawal syndrome is physical or psychological is, in this instance, academic since the stimulants are recognized as among the most potent agents of reward and reinforcement that underlie the problem of dependence.

Cocaine

The most potent stimulant of natural origin, cocaine is extracted from the leaves of the coca plant (*Erythroxylon coca*). (See figs. 7-8 and 7-9.)

Illicit cocaine is distributed as a white crystalline powder (fig. 7-10), often adulterated to about half its



C193.288

Figure 7-8.—Coca flower and bean.

volume by a variety of other ingredients, the most common of which are sugars such as lactose, inositol, mannitol, and local anesthetics such as lidocaine. Since the cost of illicit cocaine is high, there is a tendency to adulterate the product at each level of distribution. The drug is most commonly administered by being “snorted” through the nasal passages. Symptoms of repeated use in this manner may



Figure 7-9.—Coca leaf.

C193.289

resemble the congested nose of a common cold and may cause damage to the septum of the nose. Less commonly, for heightened effect, the drug is injected directly into the bloodstream. Cocaine may also be smoked by free basing. Free basing is a process using a solvent to convert the cocaine to a base. The solvent itself is dangerous and the smoking can result in overdose. This is because the drug immediately enters the bloodstream and the user cannot control dosage. Unlike such drugs as LSD and heroin, cocaine is popularly accepted as a recreational drug, facilitating social interaction. It is erroneously said to be relatively safe from undesirable side effects. Because of the intensity of its pleasurable effects, cocaine has the potential for extraordinary psychic dependency, which is all the more deceptive in view of its reputation as the recreational drug of choice.

Tolerance seldom develops; however, recurrent users may resort to larger doses at shorter intervals until their lives are largely committed to their habituation. Anxiety, restlessness, and extreme

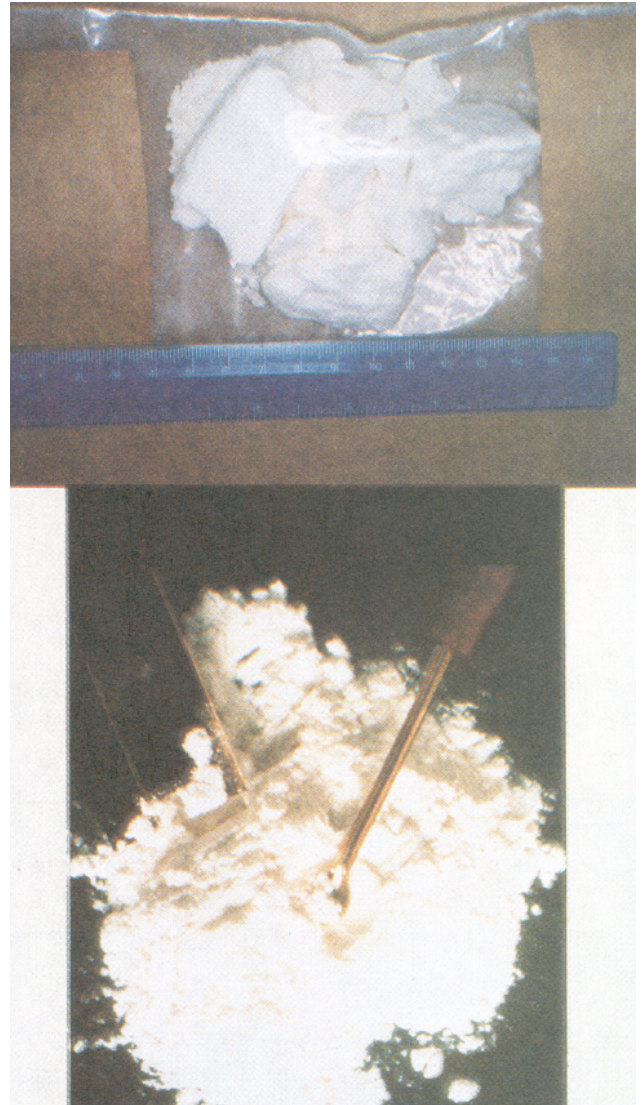

Figure 7-10.—Cocaine.

C193.290

irritability may indicate the onset of a toxic psychosis similar to paranoid schizophrenia. Tactile hallucinations so afflict some chronic users that they injure themselves in attempting to remove imaginary insects from under the skin. Others are persecuted by the fear of being watched and followed. Excessive doses of cocaine may cause seizures and death from respiratory failure.

Some drug abusers use cocaine with other drugs such as morphine or heroin. Combination shots of cocaine and heroin, cocaine and morphine, or all three are called “speedballs.”

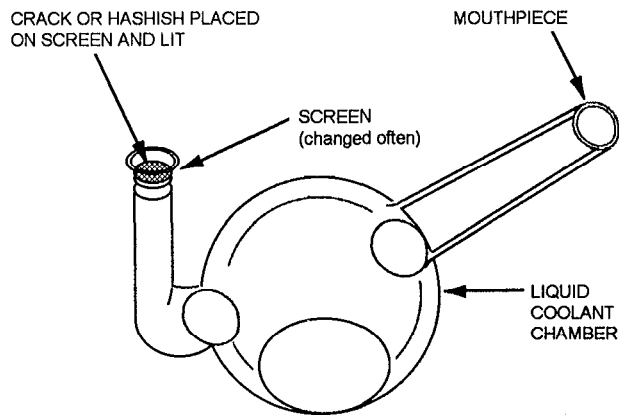

Figure 7-11.—Crack pipe (glass).



Figure 7-12.—Crack cocaine.

CI93.291

Cocaine Free Base and Crack

Traditional cocaine free base is smoked through a water pipe in which the substance was originally produced or sprinkled on a marijuana or tobacco cigarette and smoked. Crack is sprinkled on a marijuana or tobacco cigarette or mixed with either of these substances and smoked in a pipe. See figure 7-11.

Free basing is a process of converting cocaine hydrochloride (HCL) back to cocaine base for smoking. Traditional free basing involves heating ether or other flammable solvents as a critical part of the extraction process. This procedure creates an extremely hazardous situation in which risks of explosion and fire are quite high. Crack, on the other hand, eliminates the use of flammable solvents and the risks of explosion and fire.

1. Free base procedure:

Baking soda or ammonia, plus ether, are added to water and cocaine HCL. The mixture is heated, evaporating the ether, resulting in cocaine free base.

2. Crack procedure:

Baking soda or ammonia, and water, are added to cocaine HCL. The mixture is heated and cooled, then filtered to collect the crystals. The results of the process is cocaine base (crack) (fig. 7-12).

NOTE

These processes do not remove adulterants such as lidocaine, procaine, and so on.

Upon inhalation, both free base and crack are rapidly absorbed by the lungs and carried to the brain within a matter of a few seconds. The user experiences a sudden very intense rush with an equally intense high or euphoria lasting from 2 to 20 minutes. The euphoria suddenly subsides into a feeling of restlessness, irritability, and, in some cases of sustained use, post-euphoria depression. This post-euphoria period may be so uncomfortable that free base and crack smokers continue smoking, often in marathon binges, until they become exhausted or run out of cocaine.

Cocaine smoking as either free base or crack is a much more serious physical and psychiatric problem than inhaling (snorting) cocaine HCL. An enormous craving results from the rapid alternating euphorias and depressions, and the smoker tends to become compulsive and less able to control the amounts of drug used. Consequently, dosage and frequency of use tend to increase rapidly. Cocaine smokers are quite likely to develop extreme dependency in a short amount of time. Overdoses can result in fatal cardio-respiratory arrest.

Symptoms of cocaine smoking include weight loss, increased heart rate and blood pressure, depression, and paranoia. Hallucinations, manic depressive, or paranoid psychoses may be encountered in heavy users. In addition, law enforcement, paramedical, and medical personnel should be aware that the potential for violence and suicidal behavior are quite high.

FREEBASE PROCESS	CRACK PROCESS
- REMOVES DILUENTS	- REMOVES DILUENTS
- SOLVENTS USED	- DOES NOT REQUIRE SOLVENTS
- DANGER OF EXPLOSION/FIRE	NO DANGER OF EXPLOSION/FIRE
- POWDERY MATERIAL PRODUCED	- HARD FLAKY MATERIAL PRODUCED
- END PRODUCT IS COCAINE FREE BASE	- END PRODUCT IS COCAINE FREE BASE

among individuals who are either under the influence of the drug or, during the post euphoric period, develop withdrawal symptoms including chills, tremors, muscle pains, overeating, lethargy, and acute clinical depression.

Ecstasy

Ecstasy is the designer drug of the 1980s. Until 01 July 1985, ecstasy was just such a drug. Ecstasy has since been reclassified as a Schedule I drug, or one that has "no currently accepted medical use, and for which there is a lack of accepted safety for use of the drug." The designer drug ecstasy is in fact methylenedioxymethamphetamine or MDMA for short.

Ecstasy is not a new drug, for it has been around for over 75 years. Initially it was meant to be used for appetite suppression, but because of its side effects such as nausea and vomiting, it was never marketed. It can be found on the streets under the names XTC, ecstasy, Adam, Eve, Mdm, M&M, X, essence, the yuppie drug, Zan Venus and E.

Users of ecstasy claim to achieve feelings of self-confidence, expanded mental power, spirituality, love, or just good feelings. And while some users hallucinate,

most experience distortions of reality. Perhaps the most chilling aspect of ecstasy's use is the very fact it is a street drug. This type of drug is rarely pure, has no quality control during manufacturing, and can have from no amount of MDMA to any amount in any pill of ecstasy.

Any amount of MDMA can produce ill effects and physical or psychological manifestations (fig. 7-13).

MDMA may produce psychotic states that last for weeks. Since it alters the physiology of the brain, depression may occur for months after use. The drug may release suppressed emotions and result in a bad trip.

Ecstasy has the effects similar to that of LSD plus an amphetamine. Its desired effects are short-lived and may leave the user with long-term consequences, especially with repeated use.

Ecstasy can produce addiction in a very short period of time. Use of the drug is mainly found in, but not limited to, adolescents and young adults.

Methcathinone

Methcathinone is a pharmacologically active compound having a chemical structure very similar to that of the psychomotor stimulants,

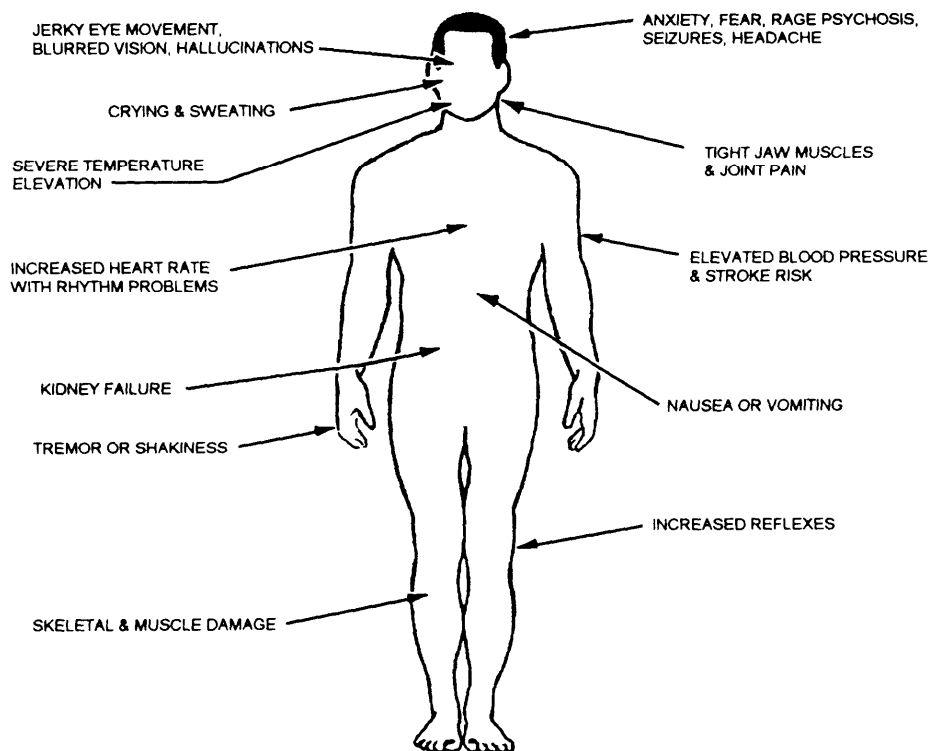

Figure 7-13.—Physiological effects of ecstasy.

methamphetamine and cathinone. It may be considered an analogue of these two stimulants. Cathinone is the primary active ingredient in the Khat plant. The leaves (containing cathinone and cathine) of the Khat plant are chewed for their euphoric and stimulant effects. Cathinone is currently in Schedule I of the 1971 Convention of Psychotropic Substances. On February 4th, 1993 in order to meet the obligations of the Psychotropic Convention, cathinone was permanently placed on Schedule I of the FCSA. As of October 15th 1993 methcathinone was permanently placed in Schedule I of the FCSA. Cathinone is not available for medical use in the United States.

Other names for methcathinone include methylcathinone, L-enantiomer, ephedrone, monomethylpropion, N-monomethylcathinone, a-N-methylaminopropiophenone, 2-(methylamino)-propio-phenone, a-(methylamino)-propio-phenone, a-N-methylaminopropiophenone, 2-(methylamino)-1-phenylpropan-1-one, AL-464, UR1431, and UR(W)1431. Ephedrone is the primary name used to indicate methcathinone in the scientific and medical community in Russia where ephedrone abuse has been and still is a big problem.

The actual effects of methcathinone in humans has only been reported to a limited extent in the scientific or medical literature. Anecdotal reports from the street indicate that methcathinone produces central nervous system stimulant effects similar to those produced by amphetamine, methamphetamine, and cocaine. Desirable effects have been reported from the use of methcathinone include a speeding mind, increase feeling of invincibility, and euphoria. Undesirable effects reported by people using methcathinone in binges primarily include paranoia, hallucinations, nervousness, insomnia, stomach pain, sweating, dehydration, anorexia, increased blood pressure, and pounding of the heart. The duration of the high is several hours and will depend somewhat upon the dose given.

Doctors working in the emergency rooms of a number of hospitals have been warned about the possible toxic effects of methcathinone. As of December 1993, U.S. scientific literature has described four emergency room cases of methcathinone. Also, at least one report in the scientific literature has briefly mentioned that ephedrone has caused deaths in the Soviet Union. No documentation for these claims was provided by the authors.

A very limited number of studies in laboratory animals indicate that methcathinone produces psychomotor stimulantlike effects similar to those produced by amphetamine, methamphetamine, cathinone, and cocaine.

Methcathinone is sold on the street in the hydrochloride salt form under the street names of "cat," "crank," "goob", and "speed." It is sold as a white to off-white powdered material, similar to cocaine. To date, only the L-enantiomeric form of methcathinone has been found on the street.

The primary route of administration is intranasal. The powdered material is cut into lines which is then snorted up into the nose in a manner similar to that of the snorting of cocaine. Methcathinone is also known to be administered by intravenous injection, smoking, and oral ingestion. Methcathinone is primarily used in a binge which last 2 to 7 days, during which time the person repeatedly administers the drug every 20 minutes to 2 hours. Each dose given ranges from 1/16 of a gram to 1/4 of a gram.

The clandestine synthesis of methcathinone appears to have started sometime around 1989 or 1990. Michigan law enforcement officials first became aware of methcathinone in January 1991. The first actual street sample (confirmed by analysis in the crime laboratory) of methcathinone was obtained by law enforcement officials in Michigan in February, 1991.

Methcathinone has been heavily abused in the former Soviet Union. It first appeared in the Soviet Union in 1982. By 1986 methcathinone was extensively trafficked and was a major drug of abuse. There it is known, not as methcathinone, but as ephedrone. It is sold on the streets in the liquid form supposedly under the street name Jeff.

Methcathinone is made by the oxidation of ephedrine in clandestine laboratories. In the United States, the primary source of ephedrine is from pharmaceutical warehouses where large numbers of 25-mg ephedrine tablets can be purchased. Oxidation is accomplished using a suitable oxidizing agent such as sodium bichromate (primary oxidizing agent used in the United States) or potassium permanganate (used in Russia). A base is required for the extraction and suitable acid is required for conversion to the acid salt form.

As of 1 January 1994, approximately 49 clandestine laboratories making methcathinone have been seized by federal, state and local law

enforcement agencies in six different states. Some of the materials characteristically found in these laboratories include filled and empty bottles of 25-mg ephedrine HCl tablets, sodium dichromate, acids such as battery acid, epon salts, Red Devil lye, toluene, acetone, coffee filters, magnetic stirrers, and various types of chemical glassware.

Ephedrone, illicitly trafficked in Russia, is made in clandestine laboratories, also via the oxidation of ephedrine. The ephedrine is obtained from solutions of ephedrine hydrochloride that is obtained from various ephedrine preparations made in Czechoslovakia and Bulgaria. The principal route of oxidation uses potassium permanganate in the presence of acetic acid.

It is important that all encounters with methcathinone be reported to the DEA, particularly to the Drug and Chemical Evaluation Section, Office of Diversion Control. This should be done by contacting your local NCIS office.

The finished product, methcathinone HCl, contains at most only very trace amounts, if any at all, of the base. Analysis of cat samples by the DEA Chicago Laboratory has shown that the methcathinone is very pure (95 percent to 100 percent pure). If there are any impurities, then it would be most likely unreacted ephedrine and dimerization products. Also note that the cat contains at most trace amounts, if any, of battery acid.

Amphetamines

Today the legal use of amphetamines is limited to the treatment of narcolepsy (a rare disorder resulting in an uncontrollable desire for sleep), peritonic behavioral disorders in children, and certain cases of obesity. The amphetamines are synthetic, nonnarcotic dangerous drugs related to a group of compounds generally known as sympathomimetic amines that act like adrenalin on the body. Amphetamines have a marked stimulating effect on the central nervous system.

Amphetamines are widely used by such people as truck drivers and night watchmen to stay awake or increase alertness. They measurably increase the body's ability to perform physical tasks for a short time. Amphetamines are also used to counteract the effects of depressant drugs.

Amphetamines appear in capsule, tablet, or liquid form. They are most often taken orally but can be injected.

Amphetamine abuse creates mental but not physical dependence. Abuse can also lead to erratic behavior and serious mental disturbance. Severity of psychotoxic effects increase when the drugs are injected intravenously. Some doctors feel that amphetamine abuse can lead to pronounced personality change. Additionally, there is a possibility that excessive amounts of amphetamines can lead to permanent organic damage to the brain.

The illicit use of amphetamines closely parallels that of cocaine in the range of its short-term and long-term effects.

Despite broad recognition of the risks, clandestine laboratories produce vast quantities of amphetamines, particularly methamphetamine, for distribution on the illicit market.

Methamphetamine

Another form of amphetamine is called speed because of its rapid stimulation of the central nervous system. The term *speed* also includes other stimulants and amphetamine-like substances but is most related to methamphetamine because of the stronger reaction. It appears in capsule, tablet, or liquid form, or as a powder in paper or foil packets.

Normal therapeutic doses of amphetamines may be from 5 to 15 milligrams, but drug abusers ("meth heads" or "speed freaks") inject many times that amount—perhaps hundreds or thousands of milligrams in a single dose due to the tolerance they have developed.

With some people, the fascination with speed lies in the initial effect of the drug. Upon injection, a rush or intense feeling of euphoria often results. The rush, like that associated with heroin, has been compared to a sexual orgasm. For this reason, speed is supposed to have aphrodisiac qualities for some users. In others, impaired sexual potency has been reported. Usually, as the abuse progresses, there is a reduction of sexual interest.

The "speed run" is a prolonged period of time over a few days or a week, where the abuser injects methamphetamine as often as is necessary to feel the desired results. During this period, the speed freak usually does not eat or sleep. Initially, he or she may feel a sense of paranoia; then becomes overly

suspicious, hallucinates, and is overactive. The combination of suspicion, hyperactivity, impulsiveness, and irrational thinking has often resulted in aggressive and destructive behavior. After a speed run, the abuser crashes and is in a state of depression and exhaustion. A period of sleep usually follows, lasting from 24 to 48 hours. Upon awakening, the speed user feels depressed and miserable.

Crystal Methamphetamine

Crystal methamphetamine or "ice" first appeared in Hawaii during 1985 but was not recognized as a problem until 1987. During that time, local Filipino gang members were the principal distributors for ice.

Methamphetamine has often been called the poor man's cocaine and has traditionally been the drug of choice of outlaw motorcycle gangs. It is commonly called meth, crystal (powder form), or crank (long time street term for speed usually referring to the pill variety). In Honolulu, crystal or ice is referred to as the rock methamphetamine, while crank is the term used for the powder form.

Methamphetamine is normally found as a white powder, but is also available in the form of a translucent crystal similar in appearance to "rock candy" or "Hawaiian salt." Ice found in Hawaii is a very pure form of methamphetamine (98 percent to 100 percent purity). See figure 7-14.

Methamphetamine can be injected, inhaled, smoked, or taken orally. In the Honolulu area, the most common method has been to smoke the drug using a glass pipe. Figure 7-15 is an illustration of a meth pipe. It is said that a person can obtain approximately 10 to 15 hits from 1 gram of ice.

Information gathered in the Honolulu area reports that several forms of crystal meth are being used. Most prevalent is the translucent or clear rock crystal. This form of meth is said to be water based and bums quickly leaving a milky white residue on the inside of the bowl. Reports also show that a yellowish crystal meth is also available. This form of meth is said to be oil based. This form of yellow meth is also said to bum slower and last longer leaving behind a brownish or black residue in the pipe.

Crystal meth (ice), is presently being sold in quantities ranging from .10 gram to an ounce. The price for .10 gram is about \$50, with the cost of an ounce going for approximately \$7,000.

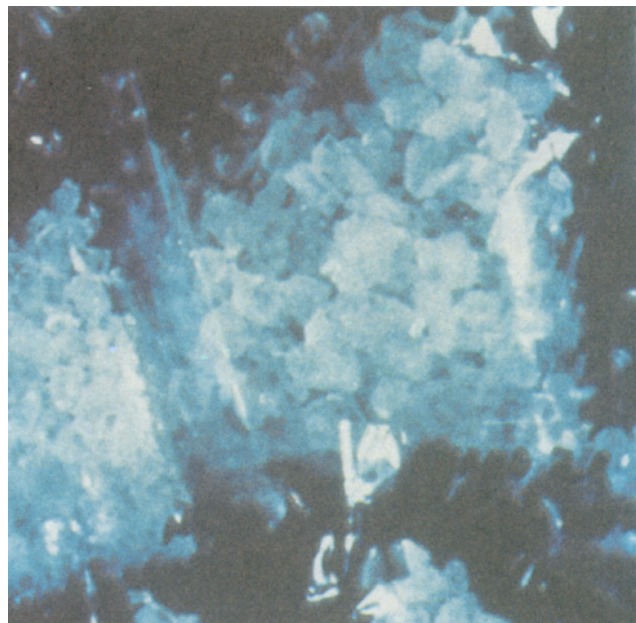

C193.292
Figure 7-14.—Crystal methamphetamine (ice).

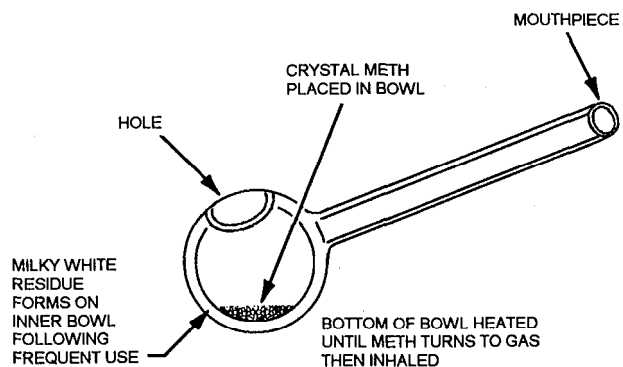

Figure 7-15.—Meth pipe.

Users feel an intense wave of physical and psychological exhilaration. The effects of the drug may last from 4 to 6 hours for a single dose and with repeated doses lasting much longer. Although entering the bloodstream rapidly, large doses may be excreted into the urine, unchanged, up to 72 hours after ingestion. The use of methamphetamine tends to keep the user awake and alert and provides temporary mood elevation; continued use causes the body to deplete its stored energy. This lack of sleep or rest prevents the replenishment of these reserves. Insomnia is usually followed by sleeping for long periods of time.

The drug tends to overtax the body and causes the body to literally bum itself up. Vitamin and mineral

deficiencies are common due to inadequate nutrition as the user keeps pushing beyond what the body can tolerate, which may lead to a rapid and noticeable loss of weight. There is lowered resistance to disease and prolonged use will cause damage to organs, particularly to the lungs, liver, and kidneys.

Continued use of methamphetamine can cause a heavy degree of psychological dependence on the drug which leads to a psychotic state, insomnia, anxiety, depression, and fatigue. Toxic psychosis similar to paranoid schizophrenia or delusional states can result from heavy short-term or long-term use. Prolonged use can also produce a heavy degree of psychological tolerance and users find they have to use heavier dosages.

Withdrawal from methamphetamine does not involve physical discomfort but can involve acute depression and fatigue. Impression can with critical proportions, in which life seems boring and unpleasant and may lead to thoughts of suicide or attempted suicide.

Progressive toxic effects are talkativeness, irritability, insomnia, anxiety, delirium, panic states, paranoid ideation, palpitation, cardiac arrhythmias, hypertension, circulatory collapse, dry mouth, nausea, vomiting, abdominal cramps, convulsions, coma, and death.

Other dangers include the rapid deterioration of physical and psychological health, since methamphetamines can erase feelings of periods of time and create the same sort of stress to the body that any long period of exertion creates. However, the user does not let his or her body recuperate and permanent damage or death is the result.

Common carriers for meth are opaque glass vials, paper bindles, or more commonly in Honolulu, clear heat-sealed cellophane packets. Common paraphernalia include syringes for the user who injects his or her drugs or glass smoking pipes (bongs).

There is a difference between a pipe used for cocaine and that used by the meth smoker. The basic difference is in the construction of the pipe.

The meth or ice pipe has only one section where the methamphetamine is placed and heated. There are no screens and no coolants in the meth pipe. The pipes used for smoking meth usually have a hole on the top of the bowl leading to the main chamber and may have a vent hole on the stem between the chamber, where

the crystal is placed, and the mouthpiece. See figure 7-15.

The ice is first placed into the chamber and heated with a lighter or other heat source until it turns to a gas. The opening in the chamber and vent hole are sealed, usually with a finger, while the crystal is being heated. Once the crystal has turned to gas, it is inhaled by the user. A telltale sign of a meth user are burn marks on the finger(s) used to seal the hole in the main chamber.

Phenmetrazine (Preludin) and Methylphenidate (Ritalin)

The medical indications, patterns of abuse, and adverse effects of phenmetrazine (Preludin) and methylphenidate (Ritalin) compare closely with those of the other stimulants. They have been subject to abuse in countries where freely available, as they are here in localities where medical practitioners write prescriptions on demand. While the abuse of phenmetrazine involves both oral and intravenous use, most of that associated with methylphenidate results from injection after the drug in tablet form is dissolved in water. Complications arising from such use are common since the tablets contain insoluble materials that, upon injection, block small blood vessels and cause serious damage, especially in the lungs and retina of the eye.

Anorectic Drugs

In recent years a number of drugs have been manufactured and marketed to replace amphetamines as appetite suppressants. These so-called anorectic drugs include benzphetamine (Didrex), chlorphentermine (Pre-Sate, and so on), clortermine (Voramil), diethylpropion (Tenuate, Tepanil, and so on), fenfluramine (Pondimin), mazindol (Sanorex), phendimetrazine (Plegine, Bacarate, Melfiat, Statobex, Tanorex, and so on), phentermine (Lonamin, Adipex-P, and so on). They produce many of the effects of the amphetamines, but are generally less potent. Abuse patterns of some of them have not yet been established, but all are controlled because of the similarity of their effects to those of the amphetamines. Fenfluramine differs somewhat from the others in that at low doses it produces sedation.

HALLUCINOGENS

Hallucinogenic drugs, both natural and synthetic, distort perception of objective reality. They induce a

state of excitation of the central nervous system, manifested by alterations of mood, usually euphoric, but sometimes severely depressive. Under the influence of hallucinogens, the pupils dilate and body temperature and blood pressure rise. The senses of direction, distance, and time become disoriented. A user may speak of “seeing” sounds and “hearing” colors. If taken in a large enough dose, the drug produces delusions and visual hallucinations. Occasionally, depersonalization and depression are so severe that suicide is possible. The most common danger is impaired judgment, leading to rash decisions and accidents. Persons in hallucinogenic states should, therefore, be closely supervised and upset as little as possible to keep them from harming themselves and others. Acute anxiety, restlessness, and sleeplessness are common until the drug wears off.

Long after hallucinogens are eliminated from the body, users may experience flashbacks—fragmentary recurrences of psychedelic effects—such as the

intensification of a perceived color, the apparent motion of a fixed object, or the mistaking of one object for another. Recurrent use produces tolerance, which tends to encourage resorting to greater amounts. Although no evidence of physical dependence is detectable when the drugs are withdrawn, recurrent use tends to produce psychic dependence, varying according to the drug, the dose, and the individual user. It should be stressed that the hallucinogens are unpredictable in their effects each time they are used.

LSD (LSD-25, Lysergide)

Lysergic acid diethylamide (LSD) is derived from the lysergic acid present in ergot, a fungus that grows on rye. The only legitimate supply of LSD for scientific research is available through the National Institutes of Mental Health, Bethesda, Maryland.

LSD is a tasteless, odorless, colorless liquid in its pure state and is normally taken orally. On the illicit



Figure 7-16.—LSD blotter paper (100 hits per square).

C193.293

market it can be found as a tablet, thin squares of gelatin (windowpanes), crystalline powder in various capsules, spots on paper squares (blotter acid) (fig. 7-16), or in liquid form in ampules. It is often impregnated in sugar cubes, cookies, or crackers and can be put on the back of postage stamps or on letter paper to be eaten by the receiver.

LSD is an extremely potent hallucinogen. One ounce of LSD contains a sufficient amount for about 300,000 doses or LSD experiences. A dose of 50 to 200 micrograms (or a quantity no larger than what may be put on the tip of a pin) would be sufficient for several trips. The average effective oral dose is from 30 to 50 micrograms but the amount of dosage in a unit varies greatly. The effects of higher doses persist for 10 to 12 hours.

LSD primarily affects the central nervous system by producing changes in mood and behavior and may cause central nervous system malfunctions. It may also dilate eye pupils, cause tremor, elevate temperature and blood pressure, and produce hyperactive reflexes in the user. Tolerance to behavioral effects of LSD develops quickly with several days of continued use. As with the other hallucinogens, physical dependence may not occur but minor mental dependence may develop.

Other manifestations of LSD include hallucinations, panic or paranoia, extreme anxiety, mental depression with suicidal thoughts or attempts, and "release" from reality to the point that the user does not know who or what he or she is. These are unpredictable reactions that may not be experienced by all users.

Mescaline

Mescaline, or peyote (fig. 7-17), is derived from the buttons of the peyote cactus that grows in Central America and the Southwestern United States. Mescaline is popular among the drug culture because it is thought to be a safe hallucinogen.

The use of mescaline and the chewing of dried peyote buttons have been practiced for centuries by various indian tribes, both as a medicine and as a part of religious ceremonies.

To facilitate ingestion by the user, peyote buttons are ground into powder, capsuled, and taken orally. Mescaline is available on the illicit market as a crystalline powder in capsules, or as a liquid in ampules or vials. Because of its bitter taste, the drug

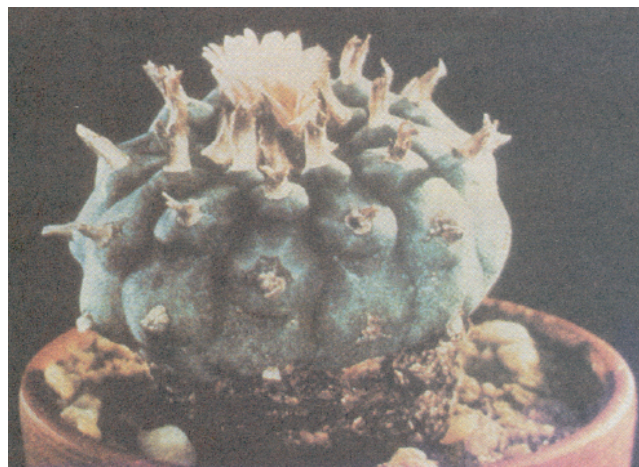

C193.294

Figure 7-17.—Peyote cactus.

is injected or eaten with food or beverage. A dose of 350 to 500 mg of mescaline produces illusions and hallucinations lasting from 5 to 12 hours and may create psychological dependence.

Psilocybin and Psilocyn

Like the peyote cactus, psilocybe mushrooms (fig. 7-18) have been used for centuries in traditional indian rites. When they are eaten, these "scared" or "magic" mushrooms affect mood and perception in a manner



C193.295

Figure 7-18.—Psilocybe mushroom.

similar to mescaline and LSD. Their active ingredients, psilocybin and psilocyn, are chemically related to LSD. They can now be made synthetically, but much of what is sold under these names on the illicit market consists of other compounds.

The drug experience lasts about 6 hours. Neither drug produces physical dependence, but users have been known to develop a tolerance to them, requiring larger doses to achieve the stimulation desired.

Dimethyltryptamine

Dimethyltryptamine (DMT) is one of the tryptamine series and is found in the seeds of certain plants native to the West Indies and South America. The powdered seeds have long been used as snuff called cohoba. This drug has been produced synthetically by clandestine laboratories in the United States for the illicit market.

DMT is usually not taken orally. Its vapor is inhaled from the smoke given off by burning the ground seeds or synthetic powder mixed with tobacco, parsley leaves, or even marijuana. It can also be injected. "Trips" are short, but mental dependence may result. DMT produces effects similar to those of LSD, but much larger quantities are needed.

Bufotenin

Bufotenin is related chemically to DMT, but is extracted, generally, from the dried glandular secretions of certain toads. It may be taken by injection or used like snuff. Its symptoms are immediate and severe, since its use results in visual disturbances and alteration of time and distance perceptions.

Diethyltryptamine

Diethyltryptamine (DET) is also chemically related to DMT, but has not yet been found in plant life. It can easily be produced in a laboratory. Injected doses of 50 to 60 milligrams cause visual distortions, dizziness, and a vague sense of time. The experience may last from 2 to 3 hours.

DOM

DOM (also known as SIP) appeared on the drug scene early in 1967. Underground newspapers promoted its use, claiming that STP was stronger than LSD. STP has been found to be about 1/15 as strong as LSD in the average dose and 200 times more

powerful than mescaline. STP stands for serenity, tranquility, and peace in the drug culture. It has been found that mild doses lead to euphoria, and stronger doses lead to genuine hallucinations. Effects have been noted to last up to 10 hours.

STP is not found in nature, but is synthesized in laboratories and is placed in tablets slightly larger than LSD capsules or tablets. One STP form is called the "magic pumpkin seed" because of its long, yellow appearance.

Methylenedioxyamphetamine

Methylenedioxyamphetamine (MDA) is a relatively new hallucinogen that has appeared in powder and tablet form. Information as to its comparative strength is still uncertain, but it appears to be weaker in reaction than LSD.

Phencyclidine and Related Drugs

According to a consensus of drug treatment professionals, phencyclidine (PCP) now poses greater risks to the user than any other drug of abuse.

Sometimes called the "peace pill," but more commonly known as PCP, this drug is sold under at least 50 other names that reflect the range of its bizarre and volatile effects. These names include "angel dust," "crystal," "supergrass," "killer weed," "embalming fluid," and "rocket fuel." It is also frequently misrepresented as mescaline, LSD, or THC. In its pure form, PCP is a white crystalline powder that readily dissolves in water. Most PCP now contains contaminants resulting from its makeshift manufacture, causing the color to range from tan to brown and the consistency from a powder to a gummy mass. Although sold in tablets and capsules as well as in powder and liquid form, it is most commonly applied to a leafy material, such as parsley, mint, oregano, or marijuana, and smoked. See figure 7-19.

PCP is as variable in its effects as it is in its appearance. A moderate amount often produces, in the user, a sense of detachment, distance, and estrangement from his or her surroundings. Numbness, slurred or blocked speech, and a loss of coordination may be accompanied by a sense of strength and invulnerability. A blank stare, rapid and involuntary eye movements, and an exaggerated gait are among the more common observable effects. Auditory hallucinations, image distortion as in a fun house

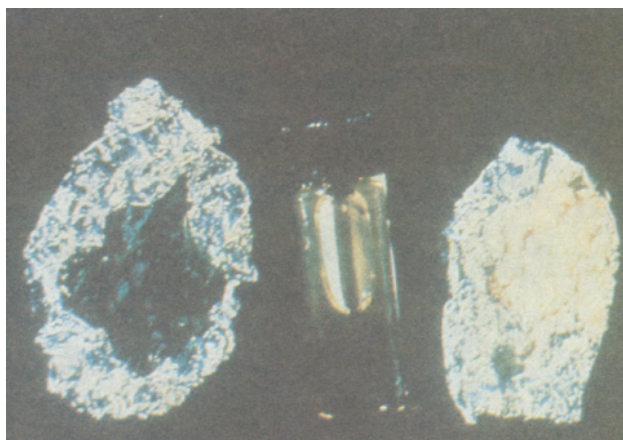

C193.296

Figure 7-19.—Forms of phencyclidine (PCP).

mirror, and severe mood disorders may also occur—producing in some acute anxiety and a feeling of impending doom, in others paranoia and violent hostility. PCP is unique among popular drugs of abuse in its power to produce psychoses indistinguishable from schizophrenia. Although such extreme psychic reactions are usually associated with repeated use of the drug, they have been known to occur in some cases after only one dose and to last, or recur intermittently, long after the drug has left the body.

CANNABIS

Cannabis sativa, the hemp plant, grows wild throughout most of the tropic and temperate regions of the world. It is a single species. This plant has long been cultivated for the tough fiber of the stem, the seed used in feed mixtures, the oil as an ingredient of paint, as well as for its biologically active substances, most highly concentrated in the leaves and resinous flowering tops.

The plant material has been used as a drug for centuries. The plant and its derivatives (such as marijuana, hashish, and hashish oil) contain the active ingredient, delta-9-tetrahydrocannabinol (THC), one of 61 cannabinoids, which are chemicals unique to cannabis.

Cannabis products are usually smoked in the form of loosely rolled cigarettes (joints). They may be used alone or in combination with other substances. They may also be administered orally, but are reported to be about three times more potent when smoked. The effects are felt within minutes, reach their peak in 10 to 30 minutes, and may linger for 2 or 3 hours. A

condensed description of these effects is apt to be inadequate or even misleading; so much depends upon the experience and expectations of the individual as well as the activity of the drug itself. Low doses tend to induce restlessness and an increasing sense of well-being, followed by a dreamy state of relaxation and, frequently, hunger—especially a craving for sweets. Changes of sensory perception—a more vivid sense of sight, smell, touch, taste, and hearing—may be accompanied by subtle alterations in thought formation and expression. Stronger doses intensify these reactions. The individual may experience shifting sensory imagery, rapidly fluctuating emotions, and a flight of fragmentary thoughts with disturbed associations. It may also result in an altered sense of self-identity, impaired memory, and a dulling of attention despite an illusion of heightened insight. This state of intoxication may not be noticeable to an observer. High doses may result in image distortions, a loss of personal identity, and fantasies and hallucinations. Very high doses may result in a toxic psychosis.

During recent years, there has been a resurgence in the scientific study of cannabis. One goal of the study has been to develop therapeutic agents that, if used as directed in medical treatment, will not produce harmful side effects. While THC can now be synthesized in the laboratory, it is a liquid insoluble in water, and it decomposes on exposure to air and light, so that it is difficult to prepare stable dosage units. Two of the most active areas of research are for the control of nausea and vomiting caused by chemotherapeutic agents used in the treatment of cancer and for decreasing intraocular pressure in the treatment of glaucoma. None of the synthetic cannabinoids have so far been detected in the drug traffic.

Three types of drugs that come from cannabis are currently distributed on the U.S. illicit market—marijuana, hashish, and hashish oil. Having no currently accepted medical use in treatment in the United States, they remain under Schedule I of the FCSA.

Marijuana

The term marijuana (or marihuana) is used in this country to refer to the cannabis plant and to any part or extract of it that produces somatic or psychic changes in man. A tobaccolike substance, produced by drying the leaves and flowering tops of the plant, marijuana varies significantly in its potency, depending on the source and selectivity of plant

materials used, Most wild U.S. cannabis is considered inferior because of a low concentration of THC, usually less than 0.5 percent. Jamaican, Colombian, and Mexican varieties range between 2.5 and 6.9 percent. The most selective product is reputed to be sinsemilla (Spanish, *sin semilla*: without seed), prepared from the unpollinated female cannabis plant, samples of which have been found to contain up to 8 percent THC. Southeast Asian “Thai sticks,” consisting of marijuana buds bound onto short sections of bamboo, are also encountered infrequently on the U.S. illicit market. See figures 7-20 through 7-26.



C193.297
Figure 7-20.—Female marijuana flower.



C193.298
Figure 7-21.—Field of marijuana.



C193.299
Figure 7-22.—Marijuana buds.



Figure 7-23.—Thai sticks.



Figure 7-24.—10-pound marijuana brick.

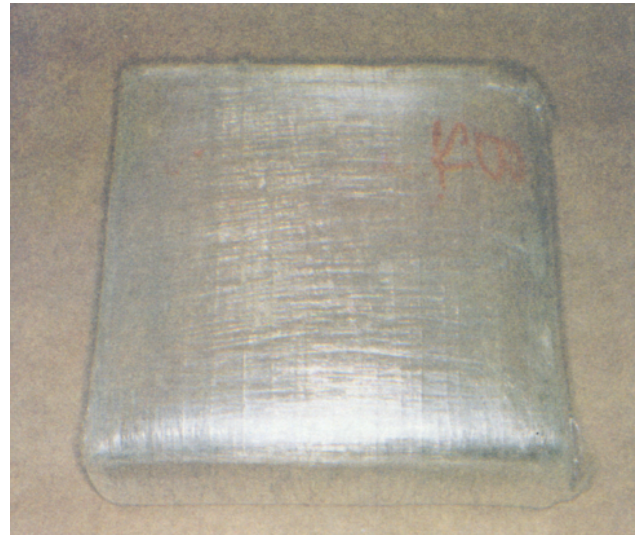

Figure 7-25.—25-pound marijuana brick.



Figure 7-26.—100-pound marijuana bale (contains 4 25-pound bricks).

Hashish

The Middle East is the main source of hashish. Hashish consists of the drug-rich resinous secretions of the cannabis plant that are collected, dried, and then compressed into a variety of forms such as balls, cakes, or cookie-like sheets (fig. 7-27). Hashish in the United States varies in potency as in appearance, ranging in THC content from trace amounts up to 10 percent. The average is reported to be 1.8 percent.

Hashish Oil

The name comes from the drug culture and is a misnomer in suggesting any resemblance to hashish other than its objective of further concentration. Hashish oil (fig. 7-28) is produced by a process of repeated extraction of cannabis plant materials to yield a dark viscous liquid, current samples of which average about 20 percent THC. In terms of its psychoactive effect, a drop or two of this liquid on a cigarette is equal to a single joint of marijuana.

ANABOLIC STEROIDS

In 1990, Congress passed the Anabolic Steroid Control Act that placed anabolic steroids as a group into Schedule III of the FCSA. This act became effective on February 27, 1991.



Figure 7-27.—Hashish (sole).

C193.304

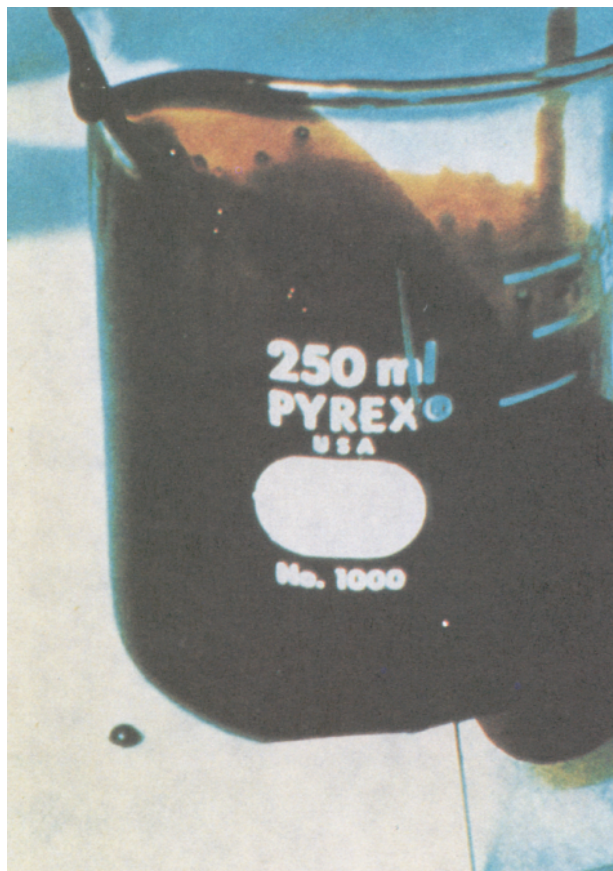

Figure 7-28.—Hashish oil.

C193.305

Definition of Steroids

The act defined the following substances, including their salts, esters and isomers, as being anabolic steroids: boldenone, clostebol, dehydrochloromethyltestosterone, drostanolone, ethylestrenol, fluoxymesterone, formebolone, mesterolone, methandienone, methandriol, methandrostenolone, methenolone, methyltestosterone, mibolerone, nandrolone, norethandrolone, oxandrolone, oxymesterone, oxymetholone, stanolone, stanozolol, testolactone, testosterone, and trenbolone. In addition, realizing that the above list was not inclusive of all anabolic steroids, the act further defined the *term anabolic steroid* to mean any drug or hormonal substance, chemically related to testosterone that promoted muscle growth. Excluded from control were certain approved veterinary implant preparations used for their intended purpose.

Steroids and the UCMJ

As a consequence of anabolic steroids being placed into Schedule III of the FCSA, Navy service members who unlawfully possess, use or disburse anabolic steroids will be subject to punishment under Article 112a of the UCMJ.

Characteristics of Steroids

Anabolic steroids may be considered synthetic derivatives of testosterone, the naturally occurring male sex hormone. They have chemical structures and produce pharmacological effects similar to that of testosterone. The effects of testosterone and other anabolic steroids may be divided into two groups. One group is the anabolic effects. The principal anabolic effect is the building up of lean body tissue, particularly muscle, via a promotion of protein synthesis and a blockade of corticosteroid-induced tissue break down. The other group of effects are the androgenic effects which involve the promotion and development of the male secondary sex characteristics. Testosterone is essential during puberty for the development of a boy into a man. At that time, the voice deepens, facial and body hair develop, male pattern baldness may appear and signs of aggressive behavior may be evident. It is important to keep in mind that all anabolic steroids, like testosterone, produce both anabolic and androgenic effects; thus testosterone and the other anabolic steroids may be more appropriately called anabolic/androgenic steroids. Anabolic steroids are formulated as oral and/or injectable preparations. With the exception of testosterone undecanoate which is formulated as a capsule preparation, all testosterone esters are strictly liquid, injectable preparations. Injectable solutions may be either water or oil based. Oil-based formulations tend to be depot preparations having a longer duration of action due to prolonged absorption of the drug.

Medical Use of Steroids

Anabolic steroids currently have limited utility in legitimate medical practice. In the United States, anabolic steroids are approved by the Federal Food and Drug Administration for the treatment of hypogonadism, hereditary angioedema, anemia and breast cancer. Anabolic steroids have also been used in the treatment of osteoporosis, malnutrition and trauma following surgery. Testosterone esters are

particularly important as replacement therapy in men whose testes do not produce adequate levels of testosterone. For the treatment of anemia, breast cancer and hereditary angioedema, newer drugs have largely, but not completely, replaced anabolic steroids.

Abuse of Steroids

Over the past 40 years, several population groups have started using anabolic steroids outside the realm of medical practice. One such group are athletes. These individuals use steroids to enhance athletic performance. Such an enhancement may be achieved by increasing muscle mass and reducing tissue breakdown allowing for more frequent training sessions. Anabolic steroid abuse has been documented at the high school, college, professional and elite levels of sport. The use of anabolic steroids is primarily found in those sporting events requiring strength. Another group uses steroids primarily to improve personal appearance, and a third group includes individuals who are in occupations where strength is a benefit. This group includes police officers and military personnel.

Steroid Use

The results of a recent national survey applied to the United States population indicates that more than 1 million people are currently or have in the past used anabolic steroids. Slightly more than half of the 1 million plus users were 26 years old or older. The incidence of anabolic steroid use among women is much lower than that occurring among men. Anabolic steroids are used in a characteristic pattern. The doses of anabolic steroids used range from therapeutic levels up to 100 times the normal therapeutic dose, depending upon the amount of strength desired for a particular sport.

Psychological Effects of Steroids

The abuse of anabolic steroids is associated with the appearance of adverse psychological effects, but psychotic reactions and hypomania have rarely been documented in steroid users. More commonly observed are increased libido, aggressive behavior and feelings of irritability, hostility and anger. Anabolic steroid abusers have been known to display violent behavior towards strangers, friends, and loved ones (i.e. wife beating). Cessation of anabolic steroid

use is known to produce in some individuals a withdrawal syndrome characterized by mental depression which in some cases is severe enough to lead to thoughts of suicide. Increased libido and aggressive behavior is also evident in women using steroids.

Signs of Steroid Use

Of interest is the ability to detect anabolic steroid use in individuals. Overt signs of possible abuse include an excellent muscular build, reduced body fat, facial edema (puffiness on the face), frequent nose bleeds, acne, enlarged breasts, needle marks and soreness in the upper buttocks area, aggressive behavior, violent behavior, and mood swings alternating between mental stimulation and mental depression. Confirmation of steroid use involves laboratory analysis of urine samples. Commonly used masking agents include diuretics, probenecid and epitestosterone. Some drugs used to alleviate the adverse effects of anabolic steroid use would include human chorionic gonadotropin, tamoxifen and diuretics.

Black Market for Steroids

In the United States there exists a black market for the distribution of steroids and other drugs to athletes, body builders, and other steroid abusers. The majority of drugs found in this black market are smuggled into the United States from other countries including Mexico, Canada and various west and east European countries. By far the most commonly encountered anabolic steroids in the black market are the various testosterone esters, particularly the propionate, cypionate and enanthate esters. Counterfeit preparations either containing no drug or some active drug are also quite common in the steroid black market. The majority of counterfeit steroid preparations found in the black market are distributed from area gyms and fitness centers by such individuals as body builders, gym owners, and personal trainers. The diversion of anabolic steroids by doctors, veterinarians, and pharmacists is also occasionally detected.

DELIRIANTS AND OTHER ABUSED SUBSTANCES

Volatile chemicals have been abused in attempts to obtain a high. The volatile solvents include model airplane glue, lacquer, thinner, gasoline, fingernail

polish remover, and lighter fluid. These substances contain xylol, cresol, naphtha, benzol, tetraethyl lead, and other chemicals that will cause acute or chronic damage to the body by attacking the oxygen level.

The primary method of abuse is by inhalation. Glue manufacturers have added mustard to their glue formulas to induce nausea and curb glue sniffing.

Propellants for aerosol sprays such as freon and nitrous oxide, if inhaled, can cause physical damage by preventing oxygen from getting to the lungs.

The deliriant of the belladonna family have been used since ancient times to produce visions, mental distortions, and confused states. They include belladonna, datura, hrnbane, and others. At the present time, only one member of this group, the jimsonweed, has come to the attention of authorities as an item of abuse. Jimsonweed grows wild in many parts of the United States.

Hawaiian baby wood rose, nutmeg, and morning glory seeds can provide delirium when taken in large amounts. Some of the seeds contain lysergic acid amide.

Thousands of naturally occurring plants that contain abusable drugs have been identified. Fortunately, most of these are found in the tropical regions, so abuse in the armed forces is not common.

DESIGNER DRUGS

A designer drug is a mood altering chemical designed to produce the same effects as a controlled substance. By designing a different chemical structure, the designer drug is intended to be legal to manufacture and distribute.

LOOK-ALIKES

Look-alike distributors, who began assaulting the nation with a blizzard of capsules and tablets early in 1980, and the manufacturers who supply them, have been dealt a series of regulatory setbacks that may bring about an end to this multimillion dollar industry. Recent federal and state actions have seriously affected the rampant trafficking in look-alikes that has been sweeping the country.

However, the Navy has recently noticed an upsurge in look-alikes. Look-alikes are carefully designed to resemble or duplicate the appearance of brand name amphetamines, barbiturates, tranquilizers, and narcotic pain killers in both capsule

and tablet form. On the street, they are known by the same slang names as their dangerous drugs counterparts: Black Beauties, Dexies, Yellows, Christmas Trees, and Rainbows. Some look-alikes contain only noncontrolled substances such as caffeine, ephedrine, phenylprop anolamine, acetaminophen, and other over-the-counter nonprescription drugs. Others contain controlled substances such as methaqualone, amphetamines, and barbiturates. Look-alikes containing controlled substances are not distributed by look-alike manufacturers.

In marked contrast to the methods used by illicit drug traffickers, look-alike distributors have conducted extensive advertising campaigns claiming their products to be both safe and legal. They have used full color brochures, magazine ads, highway billboards, and even television spots designed to appeal to teenagers and young adults. Using commercial mailing lists, distributors have mailed colorful business cards directly to young recipients.

The easy availability of look-alikes has encouraged a climate of acceptance among many young sailors and has conditioned them to the daily trafficking, handling, and consumption of these "pharmacal stimulants" and other illicit substances.

As the abuse of look-alikes grows, the health dangers of these substances become apparent. It is obvious that the young consumer who thinks that he or she has been purchasing speed or ludes and has become used to taking several look-alike capsules, tablets, and powders at a time in order to "get the full effect" runs the risk of serious overdose or death if one day he or she ingests the same number of real controlled substances. In addition to this danger, the look-alikes themselves can have serious damaging effects. The number of emergency room incidents attributable to these drugs has risen dramatically. Several deaths caused by look-alikes have been reported from around the country.

Although legal distribution of noncontrolled substances in look-alikes is not prohibited by the Federal Controlled Substances Act, the Drug Enforcement Administration considers that the distribution and sale of look-alikes, as of drug paraphernalia, encourages and contributes to drug abuse and drug profiteering.

The DEA has undertaken a complex program to control look-alikes. Many states have enacted or are considering legislation targeted against the

look-alikes. Many legitimate pharmaceutical companies refuse to sell capsules to look-alike manufacturers.

SLANG TERMS FOR DRUGS

LEARNING OBJECTIVES: Identify the commonly used slang terms for 11 drugs.

The following terms are some of the most commonly used slang terms for drugs:

Amphetamines: Bam, Beans, Bennies, Black Beauties, Black Cadillacs, Black Dex, Black Monies, Cartwheels, Chalk, Copilots, Crank, Cross, Crossroads, Crosstops, Crystal, Dexies, Dice, Double Cross, Drivers, Fives, Footballs, Hearts, Leaper, Lightning, Meth, Minibennies, Orange Hearts, Pep Pills, Rippers, Rosas, Roses, Speed, Thrusters, Truck Drivers, Uppers, Wakeups, White Cross, Whites, Yellow Barns, Zettters, Zip

Barbiturates: Abbotts, Barbs, Blockbusters, Bluebirds, Blue Devils, Blues, Christmas Trees, Courage Pills, Downers, Golfballs, Gorilla pills, Green Dragons, Lilly, Mexican Reds, Mexican Yellows, Nebbles, Nimbies, Pajaro Rojo, Pink Ladies, Pinks, Rainbows, Red and Blues, Redbirds, Red Devils, Reds, Sleeping Pills, Stumblers, Yellow Jackets, Yellows

Cocaine: Big C, Blow C, Candy, Coca, Coke, Flake, Gin, Girl, Gold Dust, Heaven Dust, Incentive, Lady, Lady Snow, Movie Star Drug, Mujer, Nose Candy, Paradise, Perico, Pimp, Polvo Blanco, Snow, Society High, Stardust, White, White Horse

Hashish: Black Russian, Goma de Mota, Hash, Soles

Heroin: Big H, Big Harry, Blanco, Boy, Brown, Brown Sugar, Caballo, Chiva, Crap, Dirt, Dust, Estuffa, H, Hard Candy, Harry, Heroína, Hombre, Horse, Junk, Mexican Brown, Mexican Mud, Polvo, Stag, Smack, Stuff, Tecata, Thing

LSD: Acid, Animal, Blotter Acid, Blue Berkeley, Blue Microdot, California Sunshine, Haze, Microdots, Paper Acid, Purple Haze, Sunshine, Wedges, Windowpanes

Marijuana: Acapulco Gold, cannabis, Colombian, Ganja, Grass, Green, Griffa, Hemp, Herb, Hootch, Hooter, J, Jay, Joint, Mary Jane, Mota,

Mutah, Panama Red, Pot, Reefer, Rockets, Sativa, Smoke, Stick, Tea, Weed, Yerba

Peyote: Bad Seed, Cactus, Mesc, Mescal, Mescal Buttons

Methaqualone: Quaalude, Quads, Quas, Soapers, Sopes, Sopor

Morphine: Cube, Dust, First Line, Gomma, Miss Emma, Morf, Mofina, Morphy, Mud

Phencylidine: Angel Dust, Angel Mist, Busy Bee, Crystal, Cyclone, DOA, Dust, Elephant, Goon, Hog, Horse Tranquilizer, Magic Mist, PCP, Peace Pill, Rocket Fuel, Supergrass, Tic Tat, White Horizon, Wobble

IDENTIFICATION OF ILLICIT LABORATORIES

LEARNING OBJECTIVES: List and explain the reasons for the proliferation of illicit laboratories. Describe a typical clandestine laboratory and the types of drugs produced.

During the past 25 years, the demand for psychoactive drugs—stimulants, depressants, and hallucinogens—has spawned a rising incidence of illicit clandestine laboratories. They were first noticed in California and now have been encountered in virtually every other part of the country.

Government actions to control the legitimate manufacture and distribution of dangerous drugs also contributed to the growth of these laboratories.

Clandestine laboratories have proliferated because of the ease of production and the limited skill needed to operate them. Equipment, chemicals, and facilities are relatively easy and inexpensive to obtain. No great skills are needed to follow the manufacturing procedures. In fact, most laboratory operators employ or are themselves “cooks” rather than trained chemists. The overall risks are minimal despite sporadic fires and explosions and the threat of discovery and arrest. The potential profits from these enterprises can be enormous.

Most clandestine laboratories are set up to manufacture a single drug, although several laboratories have been able to manufacture many different ones. The majority of clandestine

laboratories are established in rural areas and have relatively modest production capabilities. Occasionally, they are located in suburban or urban areas.

Large-scale laboratories are usually set up on rural tracts of land in large outbuildings. In some instances, these laboratories are set up in rented warehouses or other large buildings and are equipped with commercial production facilities capable of producing thousands and even millions of dosage units of controlled substances. Some laboratory operators have been students, teachers, or professional chemists or engineers who have used university or company laboratories for the illicit production of dangerous drugs.

Clandestine laboratory operators have produced almost two dozen kinds of controlled substances, including such stimulants as amphetamine, methamphetamine, and cocaine; such depressants as methaqualone and mecloqualone; such narcotic drugs as morphine, heroin, fentanyl/fentanyl analogues, alphaprodine/alphaprodine analogues, methadone, and hashish oil; and a wide variety of hallucinogenic drugs such as PCP, LSD, DET, DMT, MDA, MDMA, TMA, PHP, PCE, DMA, psilocybin, and mescaline. The two most prevalent types of laboratories in recent years have been engaged in the production of methamphetamine and amphetamine.

In an attempt to circumvent existing drug laws, some individuals have used clandestine laboratories to synthesize analogues of controlled substances. Known as “designer drugs” in the media, these controlled substance analogues usually retain the pharmacological properties of controlled substances, but, because of slight variations in chemical structure, are not specifically listed as controlled substances. Analogues of potent narcotics, stimulants, depressants, and hallucinogens have been produced in clandestine laboratories.

These analogues carry increased health risks due to their unknown purity, toxicity, and potency.

The emergency scheduling provisions of the Comprehensive Crime Control Act of 1984 and the Controlled Substance Analogue Enforcement Act of 1986 are aimed at closing the legal loopholes used by individuals who manufacture and distribute these analogues.

There are many chemicals such as solvents (ether, alcohol, chloroform, and so on) used in the synthesis of many or all of the drugs mentioned. These chemicals also have many other legitimate uses.

There are also chemicals that have little or no use other than drug manufacture. The presence of any of them is a strong indication that a drug is being synthesized. See table 7-6.

Table 7-6.—Identifying Illicit Labs by Reagents Present

Identifying Illicit Labs by Reagents Present	
LSD	
Ergotamine Tartrate	20 hours to convert Ergotamine Tartrate to LSD
Lysergic Acid	
Nitrogen	
Dimethylformamide	
Diethylamine	
Sulfur Trioxide (Sulfan B)	
Hydrazine	
Acetonitrile	
Lithium Hydroxide	
Trifloroacetic Anhydride	
Mescaline	
3, 4, 5, Trimethoxyphenylacetone	} Three hours to convert to Mescaline
3, 4, 5, Trimethoxybenzoic Acid (Gallic Acid)	
3, 4, 5, Trimethoxybenzyl Chloride	
3, 4, 5, Trimethoxybenzyl Alcohol	
Lithium Aluminum Hydride	
Tetrahydrofuran	
DMT	
Indole	} Six to nine hours to convert to DMT
Oxalyl Chloride	
Tetrahydrofuran	
Explosiv-Lithium Aluminum Hydride	
Dimethylamine	
Amphetamine Sulfate	
Phenylacetone (phenyl 2-propanone)	
Formamide	
Hydroxylamine	
Phenylacetic Acid	
Methamphetamine (called crystal on the street)	
Phenylacetic Acid	
Methylamine	
Tetrahydrofuran	
Lithium Aluminum Hydride	
Acetophenone	
Morpholine	

Upon discovery of an illicit laboratory, nothing should be disturbed until a qualified chemist and fire department are present. Chemicals on hand may be explosive or highly flammable. A sketch of the laboratory should be prepared and photographs taken. Figure 7-29 shows two types of illicit laboratories.

DRUG OFFENSES

LEARNING OBJECTIVES: Explain the investigative considerations regarding illicit drugs. Describe the apprehension of drug violators and the processing of drug evidence.

Local, state, and federal law enforcement organizations are making a concerted and aggressive effort to halt the flow of illicit drugs into the United States. This effort involves obtaining aid from other governmental agencies and governments of foreign nations. The point of the effort is to identify, apprehend, and convict the major suppliers of drugs. The connection from the individual street abuser to the head of a drug supply ring is extremely long and disguised. Obviously, the drugs abused by the military are obtained from a system that is international in scope.

INVESTIGATIVE CONSIDERATIONS

This section deals with investigations of drug abuse and abusers in the military. These abusers are usually at the user level and perhaps very low on the supplier or pusher level. However, the exploitation of the information these abusers might provide may lead to drug supply rings. Close and frequent liaison and coordination with civilian drug enforcement personnel are required.

One of the means of tracing illicit drug sources is to determine supply outlets. This can be accomplished in many ways, such as through review of completed reports of investigation, undercover investigations, informant information, or from surveillance and direct efforts to purchase drugs.

Direct Purchase

Direct purchases of drugs will be accomplished by the NCIS for your area. You may, however, coordinate, and assist NCIS agents in the investigation.

Informant Purchase

This type of purchase is setup by the NCIS when a dealer will sell only to a individual that he or she knows and not to the undercover NCIS agent. This type of individual is known as an informant.

The informant must be strip-searched before the sale for money or narcotics. Any money found on this person should be removed and be returned upon completion of the purchase. The informant should be searched again immediately after the sale to assure his or her integrity. At this time, the informant's own money should be returned. Between the two searches, the informant must be kept under constant surveillance so his or her testimony can be corroborated.

Evidence obtained through these informant buys will probably be admissible in a trial by court-martial, but the testimony of the informant may be required. The judge advocate should be consulted concerning the adequacy of a surveillance during an informant buy when the informant is lost from view, as when entering a building where the actual sale is transacted. All exits of the building should be kept under surveillance while the informant is inside.

APPREHENDING DRUG VIOLATORS

With some notable exceptions, the precautions taken and procedures used for the apprehension of any dangerous criminal apply equally to the drug violator. The seriousness of drug laws is best evidenced by the penalties invoked for their violation. The Table of Maximum Punishments in the MCM, 1984 (Rev.) provides maximum penalties for drug offenses.

Apprehension

The apprehension of a drug violator should be done as unobtrusively as possible to prevent the knowledge of the apprehension from reaching his or her collaborators. In many cases, the investigation may benefit from the discreet apprehension of the violator. The suspect should be read his or her rights as soon as possible.

When approaching a drug suspect, pay particular attention to the suspect's hands. The user may attempt to dispose of the drugs by dropping, throwing, flushing, eating, or otherwise disposing of the contraband. If the drug should be found on the ground, some distance away from the suspect, it may be

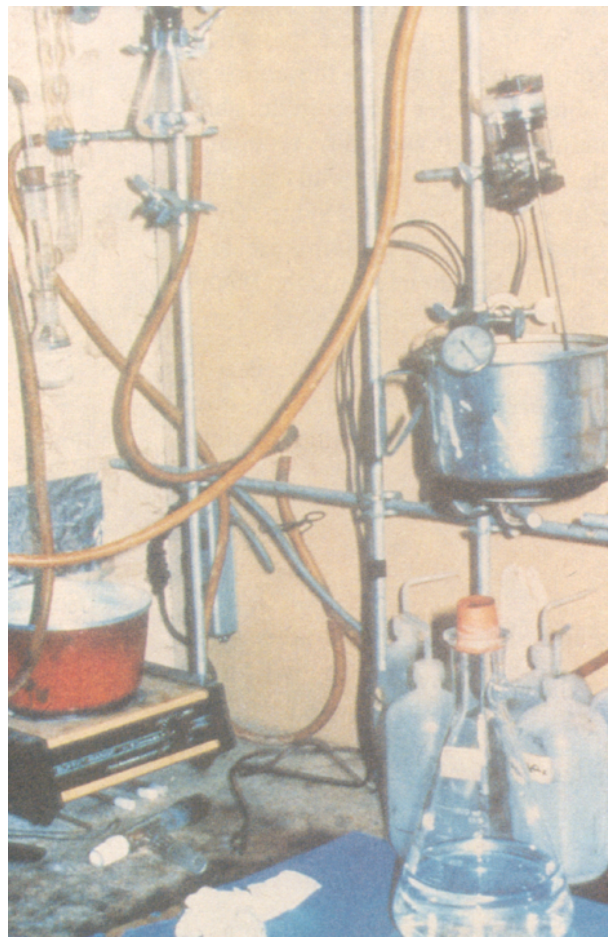

Figure 7-29.—Illicit clandestine laboratories.

C193.306

extremely difficult, if not impossible, to connect the drug with the suspect.

Since addicts can be dangerous, unpredictable, and uncooperative, attention should be given to the possibility of a weapon in their possession. As soon as possible after apprehension, suspects should be required to place their hands directly in the air or behind their heads to prevent further disposal of evidence.

You must be sure drugs taken from the custody of a person suspected of narcotics abuse have not been prescribed by medical authorities for the health and well-being of the suspect. In the event that the suspect alleges that certain seized drugs are necessary for health reasons, a medical officer's opinion must be obtained before allowing any administration of the supposed medication. The mere possession of a prescription for the drug should not, by itself, be used as justification for not seeking the opinion of a medical officer.

You should be very careful in questioning heroin addicts and should seek medical help if withdrawal symptoms begin. Failure to use these precautions could easily be considered duress by the courts and any information obtained under these circumstances could be ruled inadmissible. It should be recognized, however, that the addict will frequently feign an excessive degree of suffering to elicit sympathy and treatment. Since true withdrawal symptoms create real pain, the detainee should be taken to a medical facility for proper treatment.

If it is unknown whether the detainee is a true addict, or one who only occasionally uses a drug, a medical officer may be able to determine the degree of narcotic addiction.

Search

A thorough search should be made of the suspect, the suspect's clothing, and the area within the suspect's immediate control immediately after apprehension, or as soon as possible thereafter. You should record names, addresses, telephone numbers, and so on, from any notes or lists the subject possesses. This information may be of value in identifying dealers or persons who buy from dealers.

The small packages in which illegal drugs are usually dispensed can be easily hidden in very small spaces. Possession of even the minutest of particles may be sufficient for a conviction, You must be alert

to the presence of all tablets, capsules, small pieces of paper, and liquids, as well as the more conspicuous types of equipment such as syringes, needles, medicine droppers, and bent and/or discolored spoons.

If it is necessary for a narcotics violator to be apprehended in a building, an MA should attempt to be in a position between the suspect and the bathroom or any sink. Toilets, drains, sinks, basins, bathtubs, and showers are favorite hiding places for narcotics since they offer a quick and easy destruction capability.

Another favorite method of operation is to hang the drugs out a window by a string held in place by the closed window. Merely opening the window releases the cache and permits it to fall to the ground. Unless the drugs are seen falling from the window, the possibility of connecting the suspect to the cache is remote.

Religious artifacts should be checked thoroughly when a search is made for hidden drugs. The artifacts are often used as hiding places for drugs in hopes that searching investigators will overlook them.

The variety of hiding places for narcotics is limited only by the ingenuity of the violator. A list of common hiding places for drugs on the person follows:

Hatband	Shoes
Coat lining	Cigarettes
Shoulder pads	Lighters
Sleeves	Pens and pencils
pants	Chewing gum packages
Waistbands	Hair (including pubic)
Cuffs	Body orifices
Seams	Boots
Inside ties	False heels

PROCESSING DRUG EVIDENCE

Processing drug evidence is accomplished the same as for other evidentiary material. Take special care to ensure none of the substance is put in contact with a skin opening or inhaled. Maintaining the legal chain of custody is extremely vital to introducing drugs into evidence at the time of trial. The number of

individuals who come into possession of drug evidence should be kept to an absolute minimum.

Drug evidence is usually found in minute quantities and often in small containers. The drug evidence and the container should be placed in a suitable outer container as soon as possible and both containers marked with your initials, date, and time the evidence was obtained.

Without chemical analysis by a competent chemist, pills, capsules, powders, and vegetable matter cannot be positively identified.

In referring to substances suspected of being drugs, you must refer to the evidence by its physical appearance, such as "a white crystalline powder suspected of being cocaine," or "a vegetable matter suspected of being marijuana."

Exact weight statements should be avoided. The amount may be referred to as approximately 1 cup of vegetable matter, approximately 1/4 teaspoon of powder, or 24 tablets (or capsules).

Drugs and drug evidence should be stored in a safe or security container inside the evidence room for proper security and should be kept there at all times except when required during the course of the investigation or trial.

Field Tests

You may use field tests to screen many of the commonly used drugs offered for sale by illegal sources. There are several drug identification kits used in the field. These kits' capabilities are constantly being improved. The Navy supply system stocks a drug detection kit (stock number 6630-01-025-2852) that is currently being used and accepted for making tests to be used in making presumptive identification of drugs. The kit provides all the necessary elements to perform color tests for major narcotics and dangerous drug classifications.

The positive results of a field test identifying a controlled substance may be considered in nonjudicial punishment proceedings by the unit's CO. If the individual is stationed ashore and refuses nonjudicial punishment, any further proceedings will require a normal laboratory analysis.

Field tests are extremely reliable as negative tests (no drug present). Their reliability as positive tests varies in degree between the different tests. This changes from time to time as cutting agents that

interfere with the tests are sometimes added or sold in the illicit drug traffic. Personnel should discuss field testing with the servicing crime lab on a periodic basis to get an update on reliability of positive field tests in their locale. There are no valid field tests at present for the tranquilizers, many hallucinogens, and several other less commonly found controlled substances. Field testing of a tablet or capsule should always be preceded by an attempt to identify it in the Product section of the PDR. No test should be attempted if only one pill or tablet constitutes all the evidence in a case.

Any drug that will be used as evidence must be identified by a qualified chemist using approved procedures in an adequately equipped laboratory. If the suspected material is minute, field tests should not be attempted and all the substance should be forwarded to a laboratory for analysis.

In many cases, the color reactions produced by field tests are only indicative that the suspected sample is a drug product. **NOTE:** Many noncontrolled substances give color reactions similar to those given by controlled substances. In addition, there are numerous controlled drugs that give no color reactions at all, or give color reactions other than those usually described by field test kits.

Finally, the testing of a suspected material through sampling should never be permitted. There is a great danger that poisons might be introduced in a drug or that the material may be a poison.

Laboratory Processing

NCIS laboratories are staffed with qualified chemists and excellent equipment to identify suspected material. The chemists are prepared to testify in court, if required, as to the chemical analysis of suspected material. The laboratories use advanced techniques and sophisticated chemical compounds and equipment to analyze chemicals.

Field tests are preliminary and only indicative that a drug may be present. Laboratory examinations are precise, expert, and, in most cases, positive proof of drug existence. When suspected drugs are to be shipped to the laboratory for analysis, take care to ensure the packaging container is completely sealed and packed so spillage or breaking will not occur in transit. Tablets and capsules should be packed in sterile cotton and placed in a suitable container. A single package of evidence should never contain evidence from more than one investigation.

Disposition of Drugs

When narcotics or abuse-type drugs have served their purpose as trial evidence, the evidence custodian should make every effort to obtain disposition instructions as quickly as possible. The evidence custodian will seek the advice of the judge advocate before the destruction of the drugs or release of the drugs to the DEA. This also applies in the case of synthetic drugs. Destruction of drugs should be by fire and witnessed by a disinterested person.

DRUG ABUSE AND AIDS

LEARNING OBJECTIVES: Describe the relationship between drug abuse and acquired immunodeficiency syndrome (AIDS), Explain the ways in which the AIDS virus is transmitted within the drug culture.

An estimated 25 percent of all cases of acquired immunodeficiency syndrome, or AIDS, are intravenous (IV) drug abusers. This group is the second largest at risk for AIDS, exceeded only by homosexual and bisexual men; and the numbers may be growing. Data for the first half of 1988 show that IV drug abusers made up about 31 percent of the total reported cases.

DRUG ABUSE STATISTICS

According to the National Institute on Drug Abuse (NIDA), there are 1.1 to 1.3 million IV drug users in the United States, and, so far, about 17,500 have developed AIDS. Thousands more are infected with the virus that causes this fatal illness that kills by destroying the body's ability to fight disease.

Currently, the number of IV drug users with AIDS is doubling every 14 to 16 months. Although the number of IV drug users who carry the AIDS virus varies from region to region, in some places the majority may already be infected. In New York City, for example, 60 percent of IV drug users entering treatment programs have the AIDS virus.

Among IV drug abusers, the AIDS virus is spread primarily by needle sharing. As long as IV drug abusers are drug dependent, they are likely to engage in needle sharing. Thus, the key to eliminating needle sharing and the associated spread of AIDS is drug abuse treatment to curb drug dependence. NIDA is working to find ways to get more IV users into

treatment and to develop new methods to fight drug addiction.

Most nondrug users characteristically associate heroin with IV drug use. However, thousands of others inject cocaine or amphetamines. Recent evidence suggests that IV cocaine use is increasing and that the AIDS virus is spreading in those users. One reason for this may be because cocaine's effects last only a short time. When the drug, which is a stimulant, wears off, users may inject again and again, sharing a needle many times in a few hours. In contrast, heroin users usually inject once and fall asleep.

The apparent increase in IV cocaine is especially worrisome, drug abuse experts say, because there are no standard therapies for treating cocaine addiction. Until scientists find effective treatments for this problem, the ability to control the spread of AIDS will be hampered.

TRANSMISSION

Although needle sharing and unprotected sexual activity are the predominant method of transmission, non-IV drug users rank high in the transmission of AIDS.

Needle Sharing

Among IV drug users, transmission of the AIDS virus most often occurs by sharing needles, syringes, or other "works." Small amounts of contaminated blood left in the equipment can carry the virus from user to user. IV drug abusers who frequent "shooting galleries" (where paraphernalia is passed among several people) are at especially high risk for AIDS. But, needle sharing of any sort (at parties, for example) can transmit the virus, and NIDA experts note that almost all IV drug users share needles at one time or another.

Because not every IV drug abuser will enter treatment, and because some must wait to be treated, IV users in many cities are being taught to flush their works with bleach before they inject. Used correctly, bleach can destroy virus left in the equipment.

Sexual Transmission

IV drug abusers also get AIDS through unprotected sex with someone who is infected. In addition, the AIDS virus can be sexually transmitted from infected IV drug abusers to individuals who do not use drugs. Data from the Centers for Disease

Control show that IV drug use is associated with the increased spread of AIDS in the heterosexual population. For example, of all women reported to have AIDS, 49 percent were IV drug users, while another 30 percent were non-IV drug users themselves, were sexual partners of IV drug users. Infected women who become pregnant can pass the AIDS virus to their babies. About 70 percent of all children born with AIDS have had a mother or father who shot drugs.

Non-IV Drug Use and AIDS

Sexual activity has also been reported as the means of AIDS transmission among those who use non-IV drugs (like crack or marijuana). Many people, especially women, addicted to crack (or other substances) go broke supporting their habit and turn to trading sex for drugs. Another link between substance abuse and AIDS is when individuals using alcohol and drugs relax their restraints and caution regarding sexual behavior. People who normally practice safe sex may neglect to do so while under the influence.

SUMMARY

In this chapter, we discussed the Navy's policy on drug abuse and the maximum punishments that may be imposed. Nonnarcotic drugs were discussed next followed by the definition of the most commonly used drug terms. The formal scheduling of drugs was covered along with the factors used to classify drugs in each schedule. Next, we explained the Federal Controlled Substances Act (FCSA) and the registration, recordkeeping, distribution, and security requirements outlined by the FCSA. The federal trafficking penalties for FCSA schedule drugs and well as the various types of marijuana were then outlined. The uses and effects of six categories of drugs were pointed out along with the characteristics of deliriants, designer drugs, and look-alike drugs. Commonly used slang terms for drugs were covered followed by a discussion of illicit drug laboratories. We examined drug offenses in terms of investigation, apprehension, and processing of drug evidence. And finally, we looked at the relationship between drug abuse and AIDS.

CHAPTER 8

SMALL ARMS

As a Master-at-Arms, you will be concerned with pistols, rifles, shotguns, grenade launchers, and machine guns. Your responsibility in the field of small arms is twofold. First, you must know how to assemble, disassemble, and maintain small arms. Second, you must be able to train other personnel in the operation, safe handling, and maintenance of small arms.

CHARACTERISTICS OF SMALL ARMS

LEARNING OBJECTIVES: Define the term *small arms*. Explain small arms nomenclature. Discuss the eight steps in the small arms cycle of operation.

Strictly defined, the term *small arms* means any firearm with a caliber (cal.) of .60 inch or smaller and all shotguns. Since there are no .60-cal. weapons in the Navy, all pistols, rifles, shotguns, and machine guns up through .50 cal. are small arms. For maintenance purposes, grenade launchers have also been included in the category of small arms. Such weapons are carried or mounted aboard ship for certain watchstanders and members of the ship's internal security force.

Small arms intended for match competition (match conditioned) are not covered in this text. They are not repairable at any level other than depot, such as the Naval Weapons Support Center, Crane, Indiana.

The majority of small arms are procured from the Army and issued by the Navy to its field activities and the Fleet. Maintenance on these small arms is performed in accordance with the applicable maintenance requirement cards (MRCs), but all other information (operation, troubleshooting, parts lists, etc.) is normally found in Army technical manuals (TMs) and field manuals (FMs). FMs and TMs list the spare parts, special tools, and organizational maintenance procedures for a weapon. The FM is the operator's manual and is intended for personnel in the field who must keep the weapon firing. Indexes of Army FMs and TMs are printed in Army pamphlets 310-3 and 310-4, respectively; OP O also lists TMs, FMs, and OPs pertaining to small arms.

Before we begin the study of the individual weapons, let us examine some of the quirks in small arms nomenclature (names of the parts). Generally, terminology pertaining to the weapons themselves is fairly standard because the Navy has adopted most of the Army's system of identification. For example, the Army used the letters *M* and *A* instead of the abbreviation *Mk* (mark) and *Mod* (modification). This means that "Carbine M1A2," in Navy language, is "Carbine Mk 1 Mod 2."

The diameter of a shotgun's bore is referred to as the gauge of the shotgun. Gauge (with the exception of the .410 shotgun) is not a measurement of inches or millimeters. Instead, it is the number of lead balls of that particular diameter required to make a pound. For example, if you measured the diameter of a 12-gauge shotgun's bore, you would find it to be 0.729 inch. If you were to make a number of lead balls of this diameter and weigh them, you would find that 12 of them make a pound.

So the larger the bore of a shotgun, the smaller the gauge number. A 16-gauge shotgun has a smaller bore than a 12-gauge.

CYCLES OF OPERATION

In every weapon, there is a cycle of operation. This cycle is a group of actions that take place upon the firing of one round and occur before the firing of the next round. In the automatic small arms currently used by the Navy, the sequence or manner of accomplishing these actions may vary between weapons of different design; however, they are always performed.

There are eight steps in the cycle of operation; they are shown in figure 8-1.

Feeding

Feeding places a round in the receiver just to the rear of the chamber. In its simplest form it amounts to putting a cartridge by hand in the path of the device that will chamber the round. Most often, feeding is accomplished by a spring-loaded follower in a magazine.

Magazines have a limited capacity and cannot sustain the continuous rate of fire required by machine guns. Therefore, machine gun ammunition is belted,

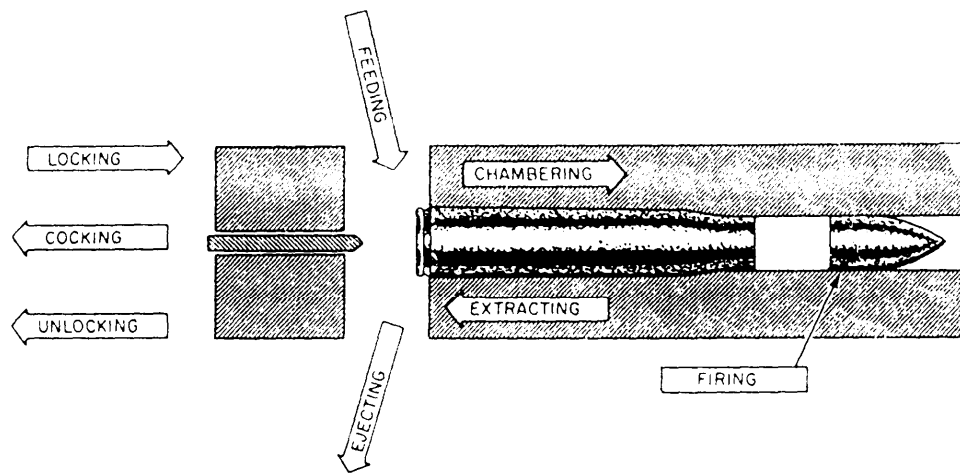

Figure 8-1.—The small arms cycle of operation.

and the rounds are fed to the rear of the chamber by cam and lever action.

Chambering

This action is required to ram a new round into the chamber. Again, in its simplest form, this amounts to placing the round there by hand. In military weapons, chambering takes place as the forward moving bolt strips the round from the feed mechanism and forces it into the chamber. The bolt closes on the cartridge and the extractor snaps into the extracting groove machined around the base of the cartridge case.

Locking

Locking holds the bolt in its forward position for a short period of time (after firing) to prevent the loss of gas pressure until unlocked by other forces. For low-powered weapons, it is possible to seal the breech for a short time by merely increasing the weight of the bolt. The bolt does start to move upon firing; but, if sufficiently heavy, it will not move far enough to release the gases until their pressure has been satisfactorily reduced. This method is used by submachine guns and other straight-blowback-operated small arms, such as the .22-cal. rimfire autoloading pistols.

Firing

Firing occurs when the firing pin strikes the primer of the cartridge.

Unlocking

Unlocking occurs after the firing of the round. Actions for unlocking are just the reverse of those required for locking. For most rifles, the first

movement of the bolt is a rotating one, disengaging the locking lugs.

Extracting

Extracting is the process of pulling the empty case back out of the chamber. The extractor (normally a small hooked piece of metal encased in the bolt) snaps over the rim of the cartridge case when the round is chambered. As the bolt moves rearward after firing, the extractor hauls out the empty brass.

Ejecting

It is not only necessary to pull the cartridge case out of the chamber, but also to throw it free of the receiver. This action is called *ejection* and is created by placing a small projection on one side of the receiver so that, as the bolt and case move to the rear, the case will strike the projection and be expelled from the weapon. This method is used in the .45-cal. pistol. Another method of accomplishing this step is to incorporate a spring-loaded ejector in the face of the bolt. In this arrangement, the case is flipped from the weapon as soon as its forward end clears the chamber. This method is used in the M14 rifle.

Cocking

Cocking is the retraction of the firing mechanism (firing pin and hammer) against spring pressure so that there will be sufficient energy to fire the cartridge in the next cycle of operation. The firing pin, hammer, or, in some cases, the bolt itself is held in a cocked position by a piece called the sear.

Again, firing is initiated by squeezing a trigger. This movement trips the sear, releasing the firing mechanism (firing pin, hammer, or in automatic weapons such parts as the bolt group or slide), causing it to move forward with enough force to discharge the round.

AUTOMATIC AND SEMIAUTOMATIC FIRING SYSTEMS

LEARNING OBJECTIVES: Explain the difference between automatic and semi-automatic firing systems. Identify and explain the three basic types of operation for small arms weapons. Distinguish between range and rates of fire.

A semiautomatic weapon unlocks, extracts, ejects, cocks, and reloads automatically. However, the trigger must be pulled each time to fire around. By this definition, the .45-cal. M1911A1 pistol is semiautomatic, though often called automatic. A fully automatic weapon keeps on firing as long as the trigger is kept pulled.

Two examples of weapons that can be found both automatically and semiautomatically are the 7.62-mm M14 rifle and the 5.56-mm M16 rifle.

SMALL ARMS OPERATING PRINCIPLES

Automatic and semiautomatic weapons are classified on the basis of how they obtain the energy required for operation. Fundamentally, small arms obtain energy from the forces that accompany the explosion created when a round of ammunition is fired. The use of these forces does not reduce the effectiveness of the weapon, but uses otherwise wasted energy.

There are three basic types of operation for semiautomatic and automatic small arms weapons: gas operated, recoil operated, and blowback operated. Figure 8-2 shows the three methods.

Gas-Operated Weapons

In gas-operated weapons, a portion of the expanding powder gases behind the bullet are tapped off into a gas cylinder located beneath the barrel. (The hole connecting the barrel and cylinder is near the muzzle end.) As the bullet passes this hole, gases push a piston rearward. The piston is connected by a rod to an operating mechanism of the weapon, such as the bolt. The piston carries the bolt aft with it, unlocking

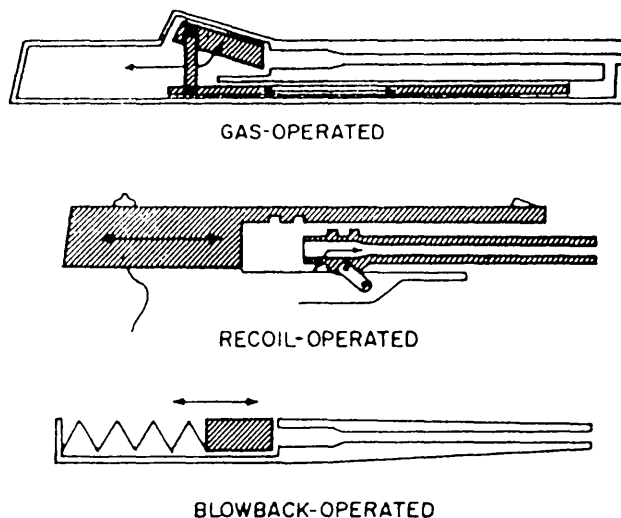

Figure 8-2. Types of operation for semiautomatic and automatic small arms weapons.

the bolt, extracting and ejecting the ammunition, and cocking the weapon.

Recoil-Operated Weapons

As a round is fired, high pressures develop behind the bullet and force it down the barrel. The force behind the bullet is also directed rearward against the breech. If the barrel and bolt are secured to one another, the entire force of recoil is felt on the shooter's shoulder. But, by design, the barrel and breech assembly slide in the frame so that the rear moving assembly may be used to compress springs or move levers, which completes the cycle of operation.

Generally, in recoil-operated weapons, the barrel and the bolt move rearward together for a short distance. Then the barrel is stopped and the bolt (now unlocked) continues to the rear against spring pressure until the empty case is ejected. The force of recoil is also used to cock the weapon and compress the spring, returning the bolt to its firing position and chambering a new round in the process.

Blowback-Operated

There are similarities between recoil-operated and blowback-operated weapons. But there are several major differences. In recoil operation, the bolt and barrel are locked together until the bullet has left the barrel, and most of the recoil thrust is spent. The combined thrust of the recoiling barrel, bolt, and some other parts is used to operate the weapon. In blowback

(inertia) operation, however, the bolt is not locked to the barrel and in most cases the barrel does not recoil. The bolt is held closed by spring pressure and the mass of the breechblock. The initial blow of the exploding cartridge starts the bolt moving rearward, but the weight of the bolt is such that it does not allow the chamber to be entirely opened until the round has left the bore. Action by a recoil spring returns the bolt to the closed position, cambering a new round.

Range and Rate of Fire

Some other important terms that apply to small arms describe their range and rate of fire. The range

of a weapon is stated in terms of *maximum range* and *maximum effective range*. The rate of fire of an automatic weapon is stated in terms of *cyclic rate of fire* or *sustained rate of fire*.

MAXIMUM RANGE— The greatest distance the projectile will travel.

MAXIMUM EFFECTIVE RANGE— The greatest distance at which a weapon may be expected to fire accurately to inflict damage or casualties.

CYCLIC RATE OF FIRE— The maximum rate at which a weapon will fire in automatic operation, stated in rounds per minute (RPM).

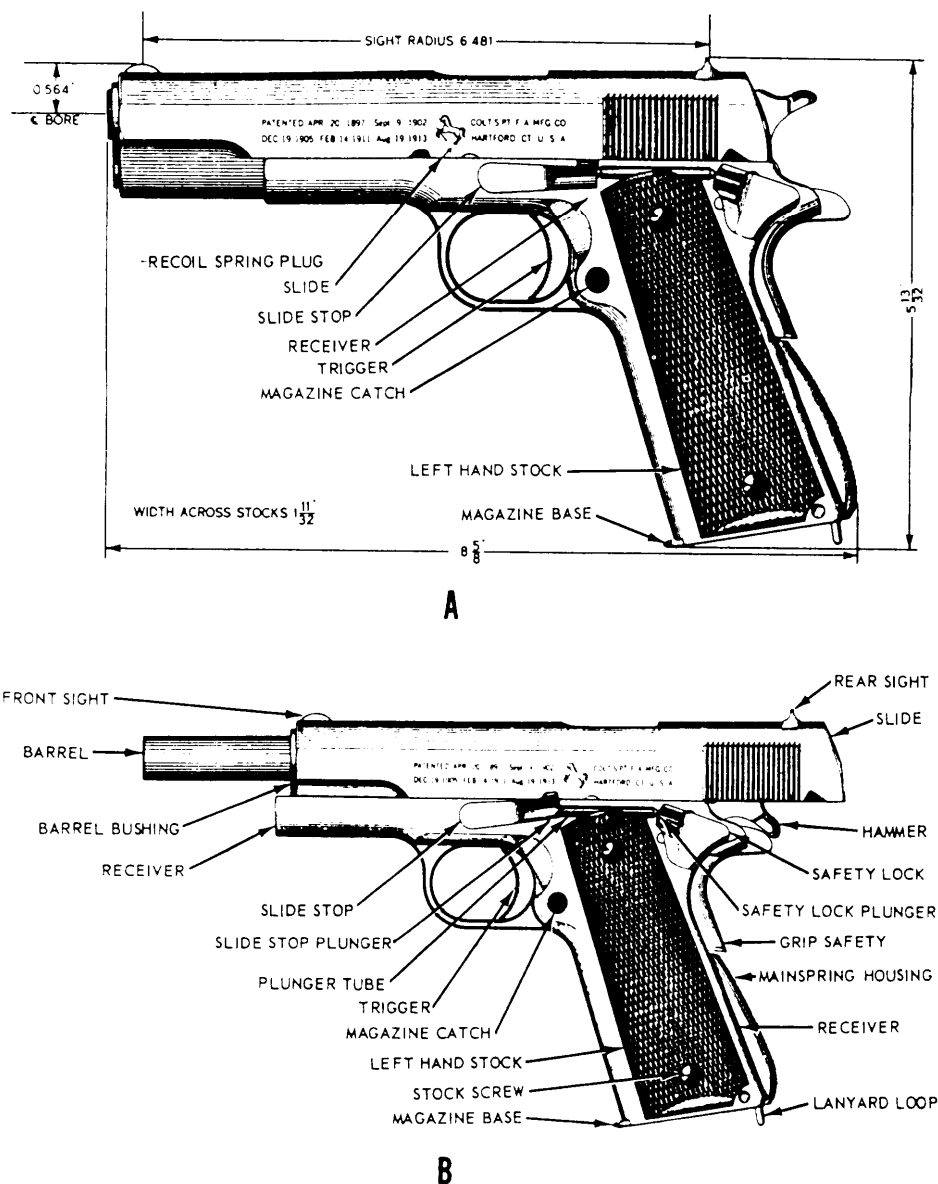

Figure 8-3.-.45-cal. M1911A1 semiautomatic pistol: A. Slide closed; B. Slide open.

SUSTAINED RATE OF FIRE— The sustained rate of fire of a weapon is normally stated in a chart. The chart correlates the average number of rounds fired per minute with the number of minutes this rate can be sustained without damage to the weapon.

HANDGUNS

LEARNING OBJECTIVES: Identify the two standard issue handguns used by the Navy. Describe the .45-cal. pistol and the steps required in disassembly and reassembly. List and describe the four safeties on the .45-cal. pistol. Describe the operation of the .38-cal. revolver and list the steps in disassembly and reassembly.

There are two standard issue handguns used by the Navy today: the .45-cal. semiautomatic pistol and the .38-cal. S&W revolver. The information presented in this chapter is primarily concerned with the .45-cal. pistol and the .38-cal. S&W revolver.

M1911A1 .45-CALIBER PISTOL

The .45-cal, M1911A1 pistol is a recoil-operated, semiautomatic, magazine-fed, self-loading handgun with fixed sights. It is often called a .45-cal. semiautomatic pistol (SAP) or a .45-cal. autoloading Colt (the manufacturer) pistol (ACP). This text will refer to it as a .45-cal. pistol. Figure 8-3 shows the pistol with nomenclature for some of the external parts.

The magazine holds seven rounds when fully loaded; one round is fired with each squeeze of the trigger. Rifling in the barrel is machined for a left-hand twist (the only Navy weapon with left-hand rifling). Empty, the pistol weighs approximately 2-1/2 pounds. It has a maximum range of a little over 1,600 yards and a maximum effective range of about 50 yards.

Disassembly

Care of the pistol includes daily preventive maintenance, prefiring cleaning, and postfiring cleaning. For daily maintenance the pistol need not be disassembled; but, for the prefiring and postfiring cleaning, the pistol should be disassembled.

There are two phases of disassembly for the pistol: general disassembly (field-stripping) and detailed disassembly. General disassembly (fig. 8-4)

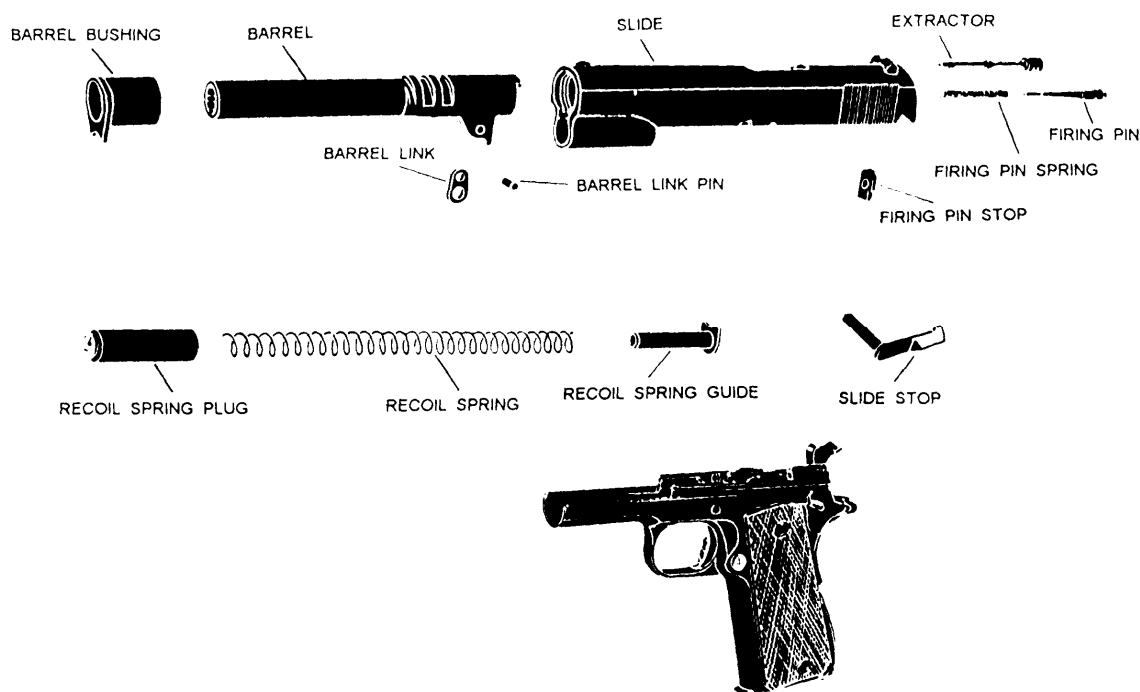

Figure 8-4-General disassembly (field-stripping) of the .45-cal. pistol.

is the disassembly necessary for normal care and cleaning, and after the weapon has been fired. This is the extent of disassembly that is generally explained to personnel such as watchstanders. The detailed disassembly of the receiver group (fig. 8-5) is the job of the Gunner's Mate during periodic cleaning and repair. Detailed disassembly is not currently called for in any 3-M system MRCs. However, it is a very good idea to perform a detailed disassembly and cleaning after heavy use, such as security force range qualifications.

To do a good job of cleaning and repair, it is essential that you know the names of the parts of the weapon. The nomenclature of parts of the pistol should be learned while practicing disassembly and assembly. As each part is removed and replaced, the nomenclature is repeated until known. While studying the disassembly and assembly of the pistol, refer to the illustrations showing the parts by name and description. Become thoroughly familiar with the parts and their functions. Knowing the names of the parts will also help you understand the operation of the weapon.

GENERAL DISASSEMBLY (FIELD-STRIPPING).— Before performing any work on the pistol, remove the magazine, pull the slide to the rear, and inspect to see that the weapon is clear. Then perform the following steps:

1. Cock the hammer and put the safety lock in its up (SAFE) position. Depress the recoil spring plug and turn the barrel bushing about a quarter-turn clockwise. This releases the tension on the spring. Allow the spring to expand slowly, under control, to prevent injury or loss of parts. Turn the recoil spring plug counterclockwise and remove it from the recoil spring. Move the safety lock back down to its FIRE position.

2. Draw the slide to the rear until the halfmoon recess (on the slide) is directly above the projection on the slide stop. Push out the slide stop from right to left.

3. Turn the pistol upside down and draw the receiver to the rear, disengaging it from the slide. Lay the receiver down.

4. Draw the recoil spring and its guide to the rear and out of the slide.

5. Take the barrel bushing out of the slide by turning it counterclockwise as far as it will go, then lifting up.

6. Lay the barrel link forward and pull the barrel out of the muzzle end of the slide.

7. Take out the firing pin by pressing on the rear of the firing pin with any pointed object until you can slide out the firing pin stop. Keep your fingers over the firing pin, allowing the spring tension to ease; then lift both firing pin and spring from the slide.

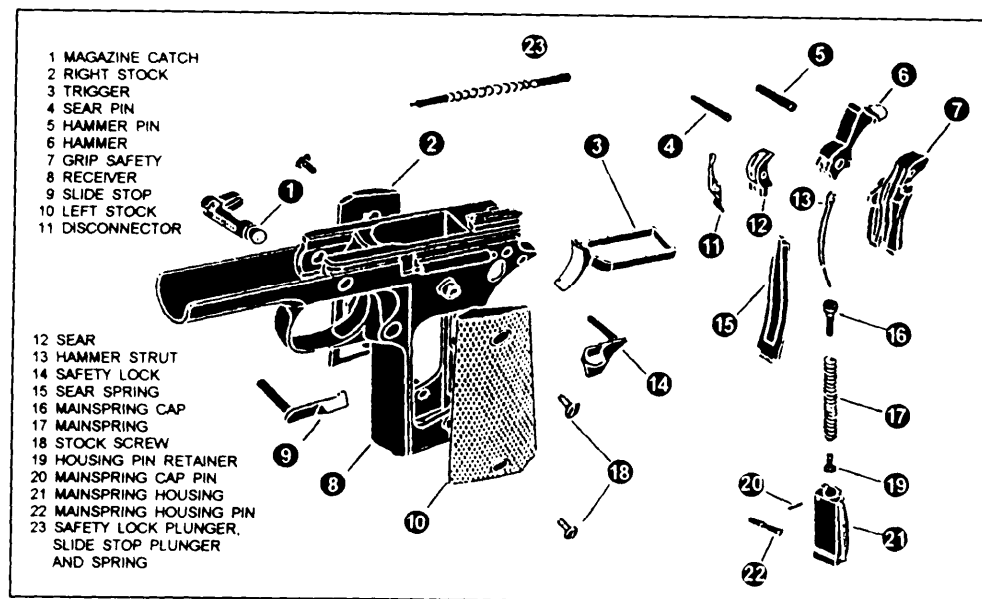

Figure 8-5.—Detailed disassembly of the .45-cal. pistol receiver group.

8. Pry the extractor out of the rear of the slide.

Assembly

To reassemble the weapon, perform the disassembly procedures in reverse order. You want to remember that all pins go in from left to right.

Safeties

There are three safety features and one positive safety on the .45-cal. pistol. The three safety features are the half-cock notch, the grip safety, and the disconnecter. The positive safety is the safety lock (sometimes called the thumb safe).

The safety lock positively locks the slide in the forward position. In addition, a stud on the safety lock (fig. 8-6, view A) blocks the shoulders of the sear to prevent any movement of the sear out of the full-cock notch of the hammer.

The half-cock notch is the notch just above the full-cock notch. It has a lip, which prevents movement of the sear from that notch when pressure is applied to the trigger. (See fig. 8-6, view B.)

The grip safety (fig. 8-6, view C) indirectly stops any movement of the sear by blocking trigger

movement. If the trigger cannot be actuated, the sear cannot move and the hammer will not fall.

The disconnecter and sear (fig. 8-6, view D) prevents firing unless the slide is fully forward and locked. Any time the slide is not fully forward, the nose of the disconnecter is forced downward. In this condition the disconnecter spade does not contact the sear when the trigger is pulled. When the trigger is pulled, the disconnecter will be pushed to the rear; but the sear remains in position, holding the hammer to the rear.

When the slide is forward, the disconnecter rides up into a recess on the underside of the slide. The spade of the disconnecter (dark area) bears against lugs on the sear. When the trigger is pulled, the trigger yoke pushes back against the disconnecter spade, which transmits the motion to the sear, rotating the sear nose out on the full-cock notch of the hammer, and the weapon fires.

Cycle of Operation

Refer to figures 8-3, 8-4, and 8-5 as we explain the functions of the pistol. We will assume that a loaded magazine is in the weapon, a round is in the chamber, the grip safety is depressed, and the trigger

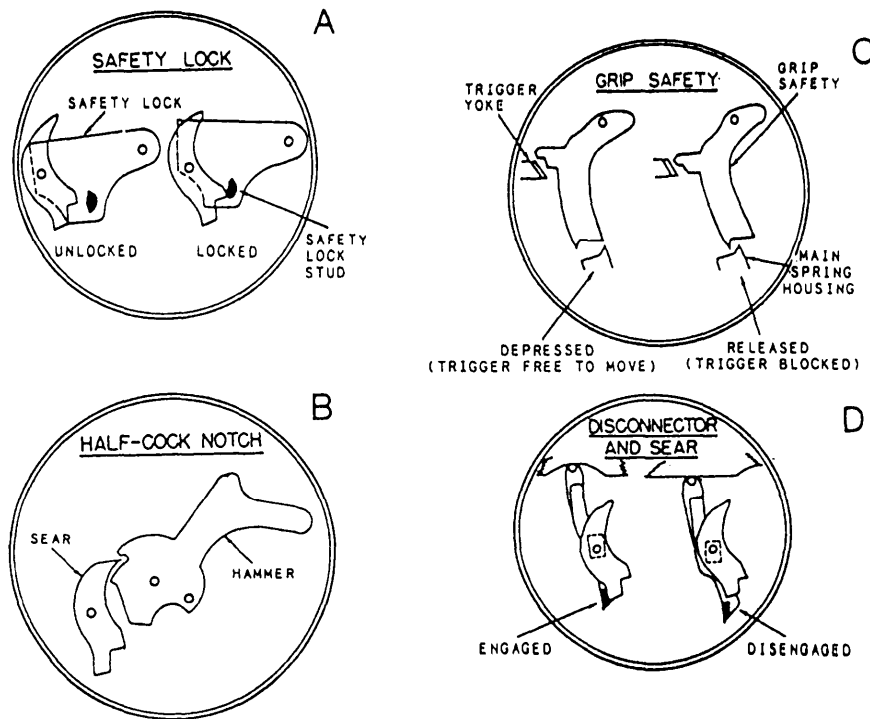

Figure 8-6.—Safeties on the .45-cal. pistol.

has been squeezed and the round fired. The cycle of operation now begins. The cycle of operation has been addressed earlier in this chapter. For more information on the M1911A1 .45-cal. pistol refer to U.S. Army TM 9-1005-211-12.

THE .38-CALIBER REVOLVER

You will find the .38-cal. S&W revolver (fig. 8-7) in armories ashore, where it is used by personnel assigned to guard or police duties. Because it is lighter than the .45-cal. pistol, the .38-cal. revolver is frequently issued to flight personnel. This weapon has about the same maximum and effective ranges (1600 and 50 yards, respectively) as the .45-cal. pistol. Figure 8-8 shows the revolver disassembled to the extent usually required for normal care.

Operation

In this discussion, operation of the revolver is limited to loading, firing, and unloading. To load the

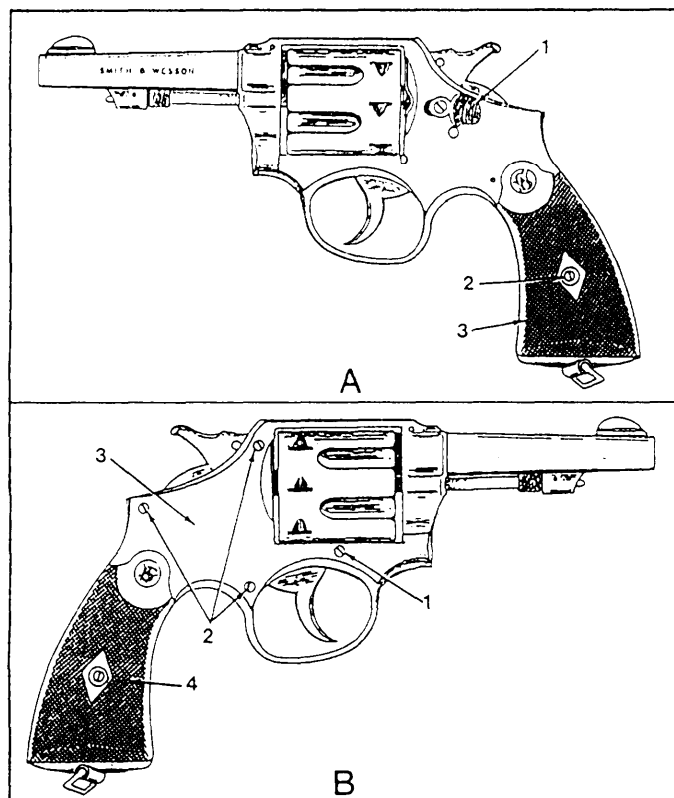

Figure 8-7.—The .38-cal. special Smith and Wesson revolver: A. Left side- (1) thumbpiece (cylinder release), (2) stock screw, (3) stock; B. Right side- (1 and 2) sideplate screws, (3) sideplate, (4) stock.

revolver, swing the cylinder out by pushing forward on the thumbpiece and applying a little pressure on the right side of the cylinder. The thumbpiece will not release the cylinder if the hammer is cocked.

NOTE

The cylinder should not be flipped out sharply because this can cause the crane to be bent, throwing the cylinder out of timing and/or alignment.

Insert a round in each of the cylinder's six chambers, and swing the cylinder back into position. The weapon is now loaded and ready to be fired.

The revolver can be fired by single or double action. For single-action firing, the hammer is pulled back with the thumb to the full-cock position for each round. This action also rotates the cylinder. The hammer is held in the cocked position by the sear until released by the trigger. In double-action firing, pulling the trigger causes the hammer to be raised to nearly its full-cock position. The hammer strut will then escape the trigger, and the spring-loaded hammer will fall and strike the cartridge. In double-action firing, the cylinder is rotated by pulling the trigger. Since it requires considerably less trigger pull for single action, this method should produce better accuracy.

The empty cartridges are ejected by swinging out the cylinder to the left and pushing the ejector plunger toward the rear of the cylinder. There are two built-in safeties on this revolver the hammer block and the rebound slide. The hammer block prevents the hammer from going far enough forward to strike the cartridge primer when both the hammer and the trigger are in the forward or uncocked position. Thus, if the revolver were dropped or otherwise struck on the hammer, the round would not be fired. The rebound slide actuates the hammer block to prevent the hammer from traveling far enough to strike the primer should the hammer slip from the thumb while being manually cocked.

Disassembly and Assembly

To disassemble the revolver, do the following:

1. Remove the stock screws and lift off the stocks. (See figure 8-7.)
2. Push forward on the thumbpiece (No. 1 in figure 8-7, view A), which actuates the cylinder latch, and

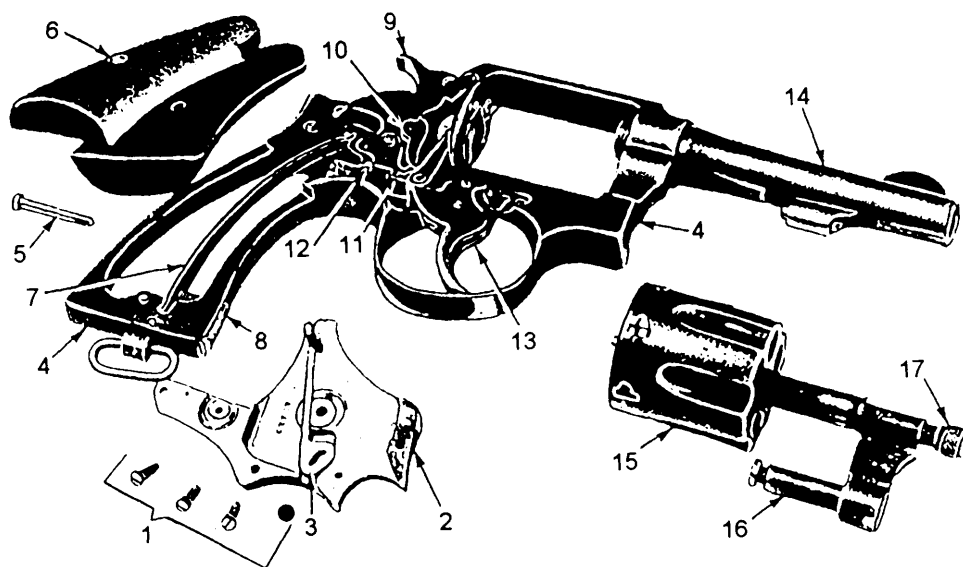

- | | | |
|---------------------|----------------------------|---------------------|
| 1. Sideplate screws | 7. Mainspring | 13. Trigger |
| 2. Sideplate | 8. Mainspring strain screw | 14. Barrel |
| 3. Hammer block | 9. Hammer | 15. Cylinder |
| 4. Frame | 10. Sear | 16. Crane or yoke |
| 5. Stock screw | 11. Rebound slide | 17. Ejector plunger |
| 6. Stocks | 12. Hammer block pin | |

Figure 8-8.—The .38-cal. Smith and Wesson revolver, completely disassembled.

swing the cylinder out to the left. With a small screwdriver, remove the sideplate screw (No. 1 in figure 8-7, view B) located directly under the cylinder. This screw retains the crane (or yoke) of the cylinder and ejector group.

3. Remove the cylinder and ejector group by pulling the ejector forward.

4. Remove the three remaining sideplate screws (No. 2 in figure 8-7, view B).

5. Remove the sideplate. (Do not use excessive force.)

6. If the revolver has a hammer block that fits over a pin in the rebound slide, remove the hammer block. If the revolver has the type of hammer block that is staked to the sideplate (early models), removal is not required.

To reassemble the weapon, if the hammer block has been removed, place the hole in the hammer block over the hammer block pin (No. 12 in figure 8-8) so that the “L” projection of the hammer block will fit between the hammer and the frame. Assemble the

sideplate, making sure the hammer block fits in the recess in the sideplate (do not force). Install the remaining parts, following the reverse order of disassembly.

For further information on the .38-cal. revolver, refer to U.S. Army TM 9-1005-206-14&P-1.

SHOULDER WEAPONS

LEARNING OBJECTIVES: Describe the operation of the M14 and M16 rifles in terms of controls, loading, and unloading. Explain the routine maintenance procedures for the M14 and M16 rifles.

Shoulder weapons are designed to be held with both hands; they are braced against the shoulder to absorb the force of recoil and to improve accuracy. Included in this group are the M14 and M16 rifles.

M14 RIFLE

The M14 rifle (fig. 8-9) is a lightweight air-cooled, gas-operated, magazine-fed shoulder weapon. It is designed for semiautomatic or full automatic fire at the cyclic rate of 750 rounds per minute. The rifle is chambered for 7.62-mm cartridges and is designed to accommodate a 20-round cartridge magazine, the M2 rifle bipod (fig. 8-10), and the M6 bayonet (fig. 8-11).

M14 Rifle Controls

Figure 8-12 shows an M14 rifle equipped with a selector for automatic operation. Position it as in A for automatic fire and as in B for semiautomatic fire. In firing for semiautomatic fire, squeeze the trigger for each round fired. For automatic fire, squeeze the trigger and hold. Most of the M14 rifles issued to the Navy will not be equipped with the automatic selector, so only semiautomatic fire will be possible.

The safety is shown in figure 8-9. To prevent firing, press the safety back from in front of the trigger guard. To permit firing, press it forward from inside the trigger guard.

If a magazine is in the rifle, press the magazine latch (fig. 8-13) and remove the magazine. Pull the operating rod handle (fig. 8-9) all the way to the rear and check to see that the weapon is free of ammunition. Then ease the operating rod forward to the locked position and move the safety (fig. 8-9) to the rear (safe position).

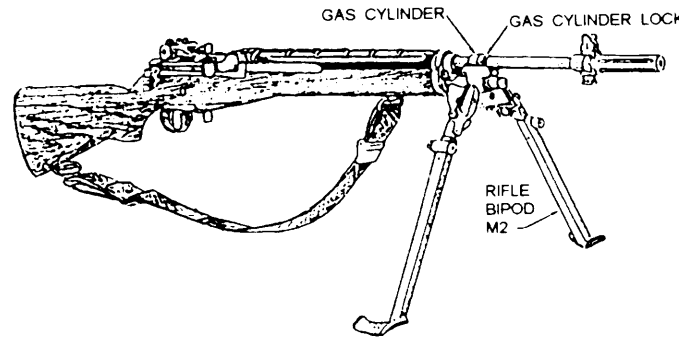

Figure 8-10.—The 7.62-mm M14 rifle with bipod installed.

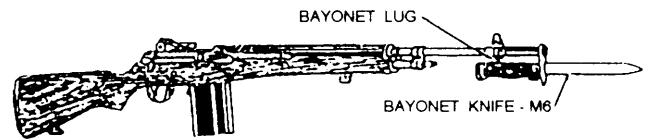

Figure 8-11.—The 7.62-mm M14 rifle with the M6 bayonet knife attached.

There are two methods of reloading an empty magazine. Figure 8-14 shows the method with the magazine in the rifle. (This method should only be used in the field, since it creates a possible accidental firing situation.) After the last round is fired from a magazine, the magazine follower will engage the bolt lock and hold the bolt in the rear position. If this fails to happen, make sure you do not have a misfire, then pull the operating handle to the rear and manually depress the bolt lock (located on the left side of the

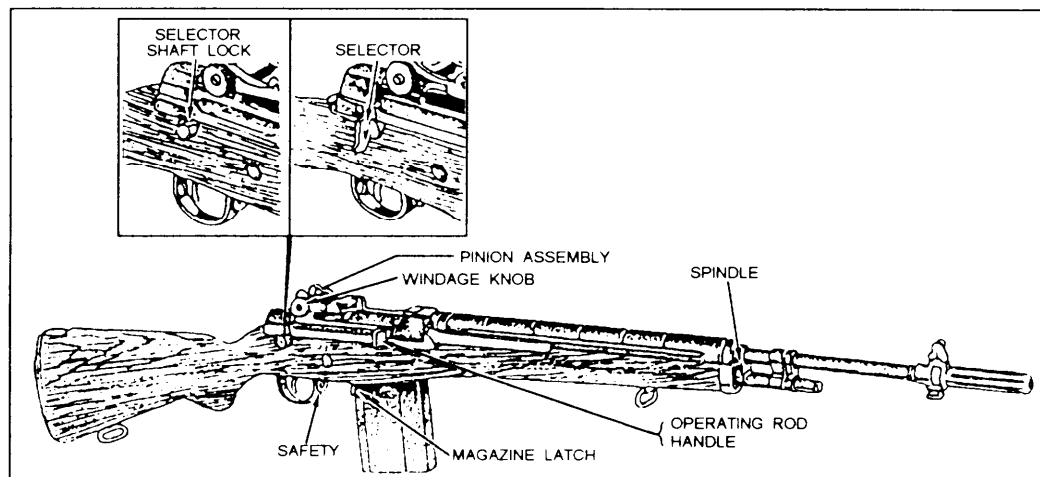

Figure 8-9.—The 7.62-mm M14 rifle and controls - right-front view.

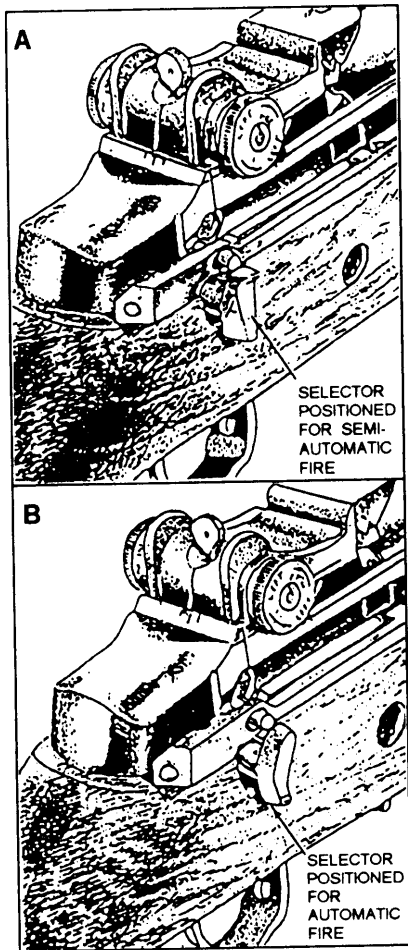

Figure 8-12.—Selector for automatic and semiautomatic fire.

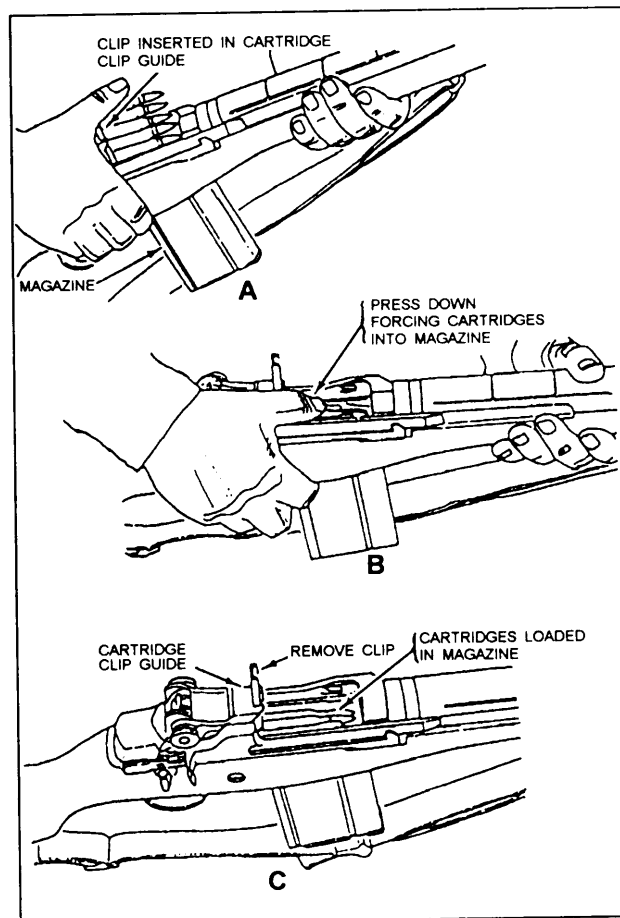

Figure 8-14.—Loading the magazine through the cartridge clip guide.

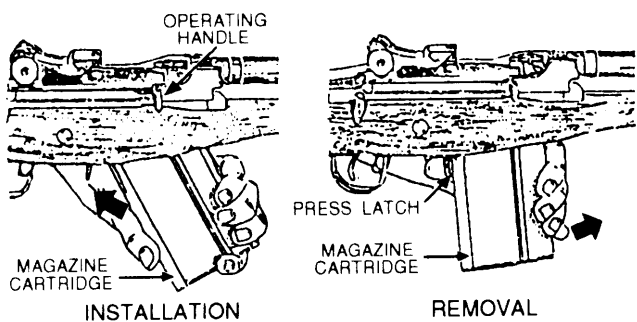

Figure 8-13.—Installation and removal of magazine.

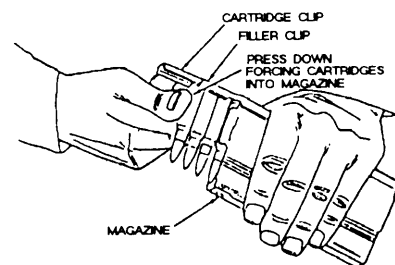

Figure 8-15.—Loading magazine when out of rifle.

receiver), and ease the bolt down against it, then engage the safety. Insert a 5-round clip into the cartridge clip guide, as shown in figure 8-14, and push the cartridges down into the magazine. Four 5-round clips will fully load a magazine. After the last clip is loaded and the clip removed, pull the operating handle to the rear to release the bolt lock, and then release the

handle. This will let the bolt go into battery, stripping and feeding the top round into the chamber. The weapon is now ready to fire.

When the magazine is out of the rifle, reload as shown in figure 8-15.

To load a full magazine into a rifle, insert the front end of the loaded magazine well into the front catch

until the front catch snaps into engagement, then pull rearward and upward until the magazine latch locks the magazine into position (fig. 8-13).

The rear sight controls consist of a windage knob and pinion assembly (fig. 8-9). The function of the windage knob is to adjust the sight laterally. To move the sight to the right, turn the knob clockwise; to the left, counterclockwise. The pinion assembly adjusts the sight aperture vertically. Turn the pinion clockwise to raise, counterclockwise to lower.

Firing the M14 Rifle

If the command desires no automatic fire, the selector on your rifle will be removed and a selector shaft lock (fig. 8-9) inserted so that the rifle is capable only of semiautomatic fire.

For a rifle equipped with a selector shaft lock, simply push the safety forward and then fire a round with each squeeze of the trigger.

For semiautomatic fire on a rifle equipped with a selector, position the selector for semiautomatic fire and then fire a round with each squeeze of the trigger.

For automatic fire with a selector (rifle cocked), proceed as follows:

1. Position the selector for automatic fire.
2. Push the safety forward.
3. Squeeze the trigger, and the rifle will fire automatically as long as the trigger is squeezed and

there is ammunition in the magazine. Release the trigger to cease firing.

4. After the last round is fired, the magazine follower (a spring-driven plate in the magazine that forces cartridges upward as rounds are expended and cases ejected) actuates the bolt lock, locking the bolt in the rearward position. When an empty magazine is removed and a loaded one inserted, release the bolt lock by retracting the operating rod, thereby drawing the bolt rearward; then close the bolt. As the bolt assembly is closed, the top cartridge in the magazine is pushed forward into the chamber.

Unloading the M14 Rifle

To unload the M14 rifle, proceed as follows:

1. Push the safety to the safe (back) position,
2. Grasp the magazine with your thumb on the magazine latch, and squeeze the latch to release it. Push the magazine forward and downward to disengage it from the front catch, and then remove it from the magazine well, as shown in figure 8-13.
3. Pull the operating rod handle all the way to the rear and lock it using the bolt catch.
4. Inspect the chamber to ensure it is clear.

The rifle is clear ONLY when no round is in the chamber, the magazine is out, the safety is set (to the rear), and the bolt is in the rear position.

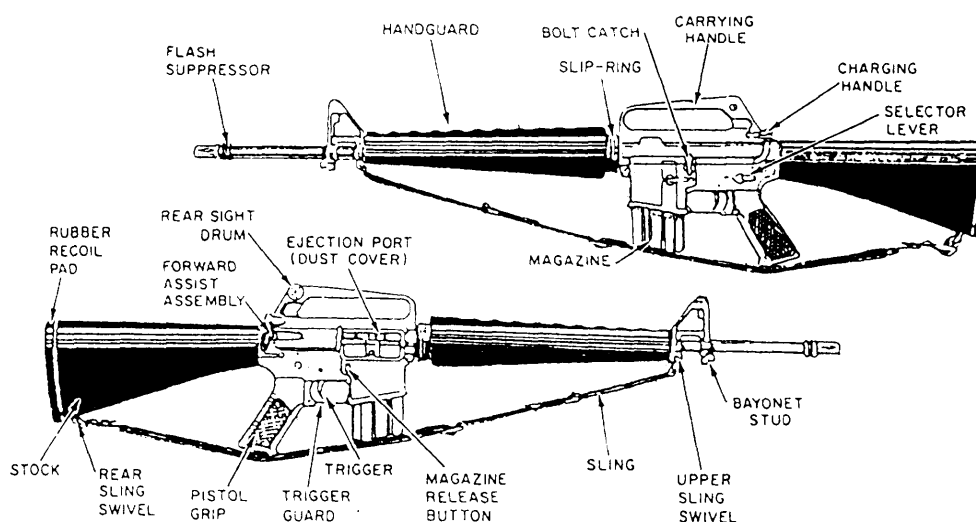

Figure 8-16.—The 5.56-mm M16A1 rifle, left- and right-side views.

M16A1 RIFLE

The M16A1 rifle (fig. 8-16) is a 5.56-mm (about .223-cal.) magazine-fed, gas-operated, air-cooled shoulder weapon. It is designed for either semiautomatic or fully automatic fire through the use of a selector lever. The M16A1, which is the version in use by the Navy, incorporates a forward assist mechanism. The forward assist was added to allow the operator to completely close the bolt should it hang up while feeding. Heavy use in dirty conditions with the close tolerances of the bolt mechanism combined cause many such feeding problems.

A “clothespin” bipod (fig. 8-17) is used in the prone and foxhole positions. The bipod is attached to the barrel directly beneath the front sight, between the bayonet lug and the front sling swivel.

Clearing the M16A1 Rifle

The first consideration in handling any weapon is to make it safe by clearing it. To clear the M16A1 rifle, place the butt against the right thigh and proceed as follows:

1. Attempt to point the selector lever toward SAFE, the position shown in figure 8-18. If the weapon is not cocked, the selector lever cannot be pointed toward SAFE. If this is the case, do not cock the weapon at this time; instead, go on to the next step in clearing.

2. Remove the magazine as shown in figure 8-19. Grasp it with the right hand (fingers curled around the front of the magazine, thumb placed on magazine catch button); apply pressure on the magazine catch button

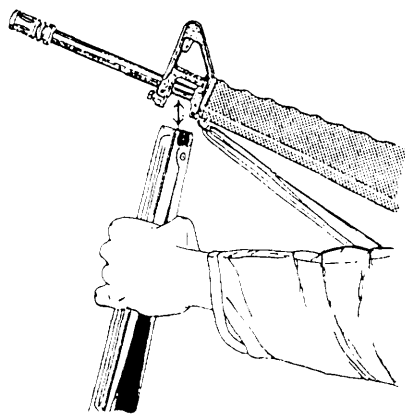

Figure 8-17.—Attaching the clothespin bipod to the M16A1 rifle.

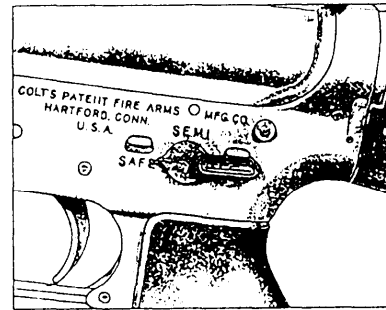

Figure 8-18.—Selector lever pointing to SAFE.

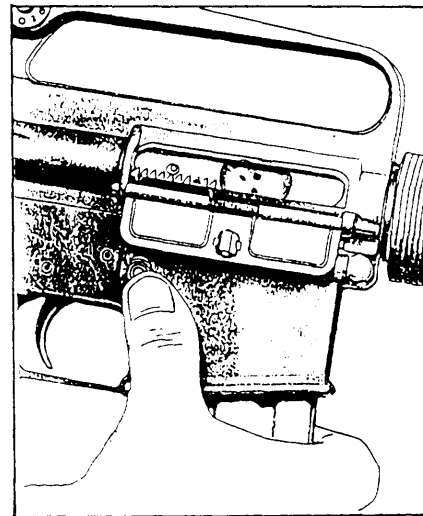

Figure 8-19.—Removing the magazine.

with the thumb; and pull the magazine straight out of the weapon.

3. Lock the bolt open as shown in figures 8-20 and 8-21. Grasp the charging handle with thumb and forefinger of right hand; depress the charging handle latch with right thumb; and pull to the rear (fig. 8-20).

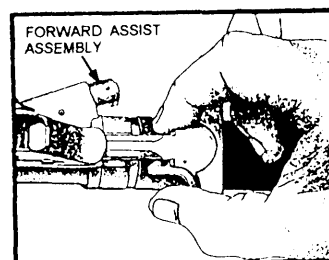

Figure 8-20.—Pulling the charging handle rearward.

When the bolt is at the rear, press the bottom of the bolt catch with the thumb or forefinger of the left hand (fig. 8-21). Allow the bolt to move slowly forward until it engages the bolt catch, and return the charging handle to its forward position.

4. Inspect the receiver and chamber of the weapon by looking through the ejection port to ensure that these spaces contain no ammunition.

5. Check the selector lever to ensure that it points toward SAFE, and then allow the bolt to go forward by depressing the upper portion of the bolt catch.

CAUTION

The selector must be in the SAFE position to prevent damage to the automatic sear.

Loading the Magazine

The magazine has a capacity of 20 rounds and may be loaded with any amount up to that capacity. The magazine follower has a raised portion generally resembling the outline of a cartridge. Cartridges are loaded into the magazine so that the tips of the bullets point in the same direction as the raised portion of the follower (fig. 8-22).

A magazine charger and magazine charger strip (fig. 8-23) are provided to facilitate loading of the magazine. The magazine charger is connected to the magazine and fully seated. The charger strip is inserted into the magazine charger until fully seated. Pushing on the top cartridge will force cartridges into the magazine.

Loading the Rifle

With the weapon cocked, place the selector lever on SAFE. The magazine may be inserted with the bolt either open or closed; however, you should learn to load with the bolt open. This reduces the possibility of a

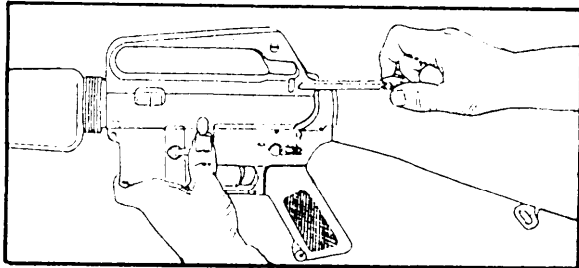

Figure 8-21.—Locking the bolt open.

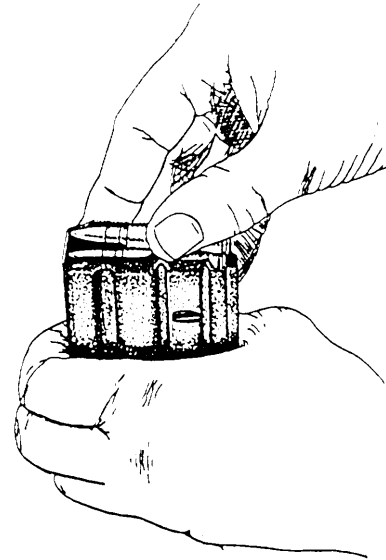

Figure 8-22.—Loading cartridges into the magazine.

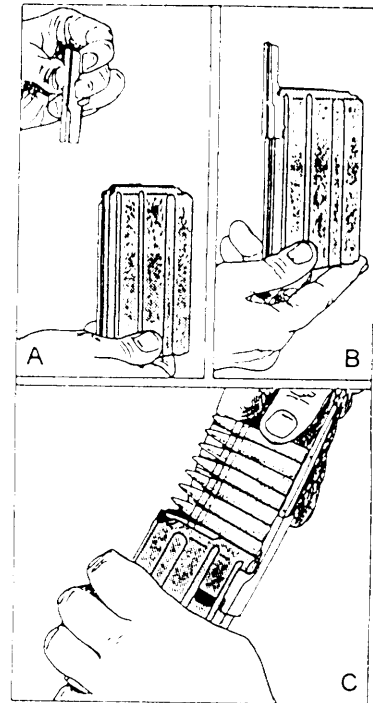

Figure 8-23.—Loading cartridges into magazine with magazine loading strip and charger.

first-round stoppage and saves the time required to chamber the first round by pulling back the charging handle.

Open the bolt and lock it open as previously described. Hold the stock of the rifle under the right

arm with the right hand grasping the pistol grip, and point the muzzle in a safe direction. With the left hand, insert a loaded magazine into the magazine feedway. Push upward until the magazine catch engages and holds the magazine. Rap the base of the magazine sharply with the heel of the hand to ensure positive retention. Then release the bolt by depressing the upper portion of the bolt catch as previously described. The bolt, as it rides forward, will chamber the top round.

If you load the rifle with the bolt closed, you chamber the top round by pulling the charging handle fully to the rear and releasing it.

NOTE

Do not "ride" the charging handle forward with the right hand. If the handle is eased forward from the open position, the bolt may fail to lock. If the bolt fails to go fully forward, strike the forward assist assembly (fig. 8-20) with the heel of the right hand.

Unloading the Rifle

To unload the rifle and make it safe, place the selector lever on SAFE; press the magazine catch button and remove the magazine; pull the charging handle to the rear; inspect the chamber to ensure it is clear; lock the bolt earner to the rear by depressing the lower portion of the bolt catch; and return the charging handle forward.

The rifle is clear (and therefore safe) ONLY when no round is in the chamber, the magazine is out, the bolt carrier is to the rear, and the selector lever is on the SAFE setting.

Gun Maintenance

A clean, properly lubricated and maintained M16A1 rifle will function properly and fire accurately when needed. To keep the rifle in good operating condition, you must properly care for it and perform maintenance according to set procedures. Procedures

for the care and cleaning of the rifle can be found on the 3-M System's MRCs or in the Army's TM 9-1005-249-10.

Maintenance of the M16A1 rifle is generally the same as for other small arms previously discussed. The bore and chamber must be kept free of residue and foreign matter. Inspect, while cleaning and lubricating, all sliding or working surfaces for burrs, cracks, or worn areas (repair or replace as necessary) and lubricate with a thin film of lubricant. Remove dirt, rust, grit, gummed oil, and water as these will cause rapid deterioration of the inner mechanism and outer surfaces.

SHOTGUNS

LEARNING OBJECTIVES: List the technical specifications and explain the functions, loading, unloading, and mechanical safety of the Remington M870 shotgun. Describe the operating cycle of the M870 shotgun and determine the required routine maintenance. Recognize the differences between the Remington M870 and Mossberg M500 shotgun.

Shotguns used by the Armed Forces are military versions of civilian models procured from military specifications. The Remington model 870 (M870) and the Mossberg Model 500 (M500) are the Navy's standard issue riot-type shotguns. However, in this chapter, only the Remington M870 (fig. 8-24) will be described in any detail. The Mossberg 500 is very similar to the Remington 870 in construction and operation and is covered by the same MRCs for maintenance.

REMINGTON M870 SHOTGUN

The M870 shotgun, used by the Navy for guard work, is a manually operated, magazine fed (tubular), pump-action shoulder weapon.

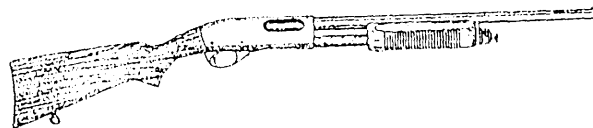

Figure 8-24.-Remington M870 shotgun.

Technical Description

Length of shotgun	39 inches (approximately)
Length of barrel	20 inches
Magazine capacity—rounds	4
Shell (gauge)	12
Ammunition	12 gauge 2-3/4 inch 00 buck, military round
Safety	Cross bolt type
Fore-end)	Plain beaver tail style

Functioning of the Remington M870

The M870 shotgun can be loaded and unloaded in several different ways. The following paragraphs describe the different options for loading and unloading the M870 and how to operate the mechanical safety. Single-load puts a round directly into the chamber for fast firing, while magazine-load fully loads the tubular magazine but does not chamber a round. Loading the barrel from the magazine chambers a round from the loaded tubular magazine for firing.

SAFETY.— Before loading or unloading, push the safety (fig. 8-25) across the rear of the trigger, left to right, to the safe position (the red band on the safety will not show).

FIRE POSITION.— Push the safety across to the fire position (the red band on the safety will show). The trigger can then be pulled to fire the gun.

SINGLE LOAD.— Push the safety to the safe position. Press in the action bar lock (fig. 8-25) if the action is cocked and pull the fore-end fully to the rear.

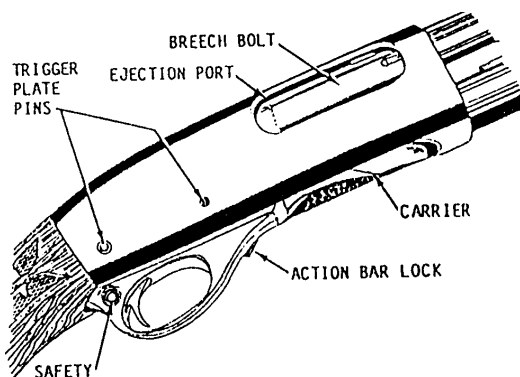

Figure 8-25.—Remington M870 receiver nomenclature.

Place the shell into the open ejection port upon the downthrust carrier. Slide the fore-end toward the muzzle to load the shell into the barrel chamber and lock the action closed,

MAGAZINE LOAD.— Push the safety to the safe position. Slide the fore-end completely forward to close the action. Turn the gun bottom upward and press the shell against the carrier, then forward fully into the magazine. Make sure that the rim of the shell snaps past the shell latch to prevent the shell from sliding back over the carrier. Should this occur, open the action or, if necessary, remove the trigger plate assembly (fig. 8-26), if the gun is cocked, to remove the shell.

LOADING THE BARREL FROM THE MAGAZINE.— Shells can be fed from the loaded magazine by simply pumping the fore-end. Press in the action bar lock if the gun is cocked. Pump the fore-end back and forth to open and close the action.

UNLOADING THE GUN.— Push the safety to the safe position. Press in the action bar lock; pull the fore-end (figure 8-27) slowly rearward until the front end of the shell from the barrel is even with the ejection port in the receiver. Lift the front of the shell outward and remove it from the ejection port. Continue pulling the fore-end back fully until the next shell releases from the magazine. Roll the gun sideways to allow the released shell to drop from the

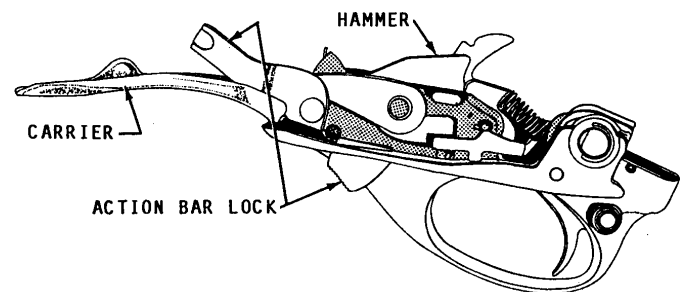

Figure 8-26.—M870 trigger plate assembly.

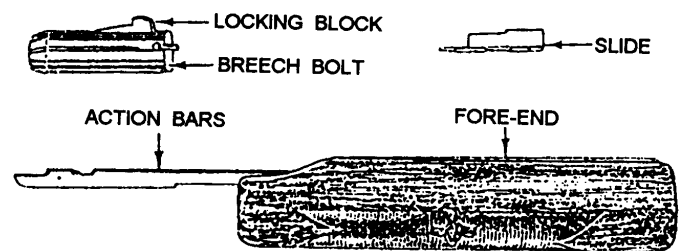

Figure 8-27.—M870 fore-end assembly.

ejection port. Close the action by pushing forward on the fore-end. Continue this same method until the magazine and gun are empty.

CAUTION

Open the action and check the shell chamber in the breech and magazine to make sure no rounds remain in the gun.

UNLOADING THE BARREL ONLY.— Push the safety to the on safe position. Press in the action bar lock and pull the fore-end rearward until the front end of the shell from the barrel is even with the front end of the ejection port. Lift the front end of the shell from the receiver as described previously. A shell with different powder and shot combination may then be placed in the chamber and the action closed without disturbing shells in the magazine.

Remington M870 Operating Cycle

The entire operating cycle of the M870 shotgun is completed by pulling the trigger, sliding the fore-end rearward to open the action, and forward again to close the action. The fore-end is mounted on double-action bars and is fully controlled and operated by the shooter.

Assuming the magazine is loaded and one shell is in the chamber and locked, the gun is ready to fire. The firing cycle follows.

FIRING.— With the cross bolt safety pushed to the fire position (red bands showing), the gun is fired by pulling the trigger. The top part of the trigger rotates forward carrying the right connector, in ready position, forward against the sear. This movement pivots the sear out of engagement with the hammer. The released hammer, with force from the spring-loaded hammer plunger, strikes the firing pin, which is pinned in the breech bolt and spring retracted. The firing pin strikes the primer and ignites the powder charge. During the upward movement of the hammer, it engages the action bar lock just before it strikes the firing pin. Downward movement of the front of the action bar lock is restrained until pressure against it is briefly released by the shooter's arm as it recoils rearward. When the action bar lock is released, the forward end of the action bar lock is lowered from its position at the rear of the left action bar, and the rear section rises and lifts the left connector which lifts the right connector from contact with the sear. This completes the "lock" or firing cycle. The action bar

lock serves a twofold purpose. It serves as a safety feature that disconnects the trigger assembly and sear until a shell is fully seated in the chamber and the breech mechanism again is ready for firing, and it locks the action closed.

After pulling the trigger, pulling the fore-end rearward will open the action and accomplish the unlock, extract, eject, cock, and feed cycles.

UNLOCK.— The initial rearward movement of the fore-end, after the shell has been fired, carries the slide to the rear of the breech bolt. As the breech bolt passes to the rear, the slide cams the locking block from the recoil shoulder of the barrel. This movement unlocks the action and cams the firing pin to the rear where it is locked and prevented from protruding through the bolt face.

EXTRACT.— Continued rearward movement of the fore-end opens the action. The breech bolt moves back and the fired shell is extracted from the chamber. The extractor claw, which overhangs the bolt face, grips the rim of the shell tightly as extraction

progresses. Pivot pressure is exerted on the rear of the extractor by the extractor plunger and spring.

EJECT.— As the extracted shell clears the chamber, its base engages a shoulder on the rear of the ejector spring, which is located on the left side of the receiver. This pivots the shell so its front end is ejected first through the ejection port.

COCKING.— Before ejection occurs, the breech bolt in its rearward travel forces the hammer down against the coiled hammer spring to engage the sear. Sear spring pressure locks the sear in a notched position against the cocked hammer.

FEEDING.— The final movement of fore-end carries the slide, breech bolt assembly, and locking block to the rear of the receiver. Termination of this rearward stroke also permits the left action bar to cam the left shell latch, in turn, releasing the first shell from the magazine. The released shell is forced from the magazine by a spring-loaded follower. The carrier receives the released shell. Meanwhile, the right shell latch, which was cammed into the magazine way by the right action bar during the extraction cycle, intercepts the base of the second shell.

With a shell resting on the depressed carrier, forward movement of the fore-end will close the gun's action and complete the loading and locking cycles.

LOADING.— Forward movement of the fore-end will carry with it the slide, breech bolt, and locking block. The carrier dog is engaged by the slide, pivots the shell carrier upward, and places a shell in the path of the returning breech bolt. As the bolt continues to advance, it depresses the ejector spring and the shell is picked up and loaded into the chamber. The earner dog is released by the passing slide, forced up by the carrier dog follower, and pivots the carrier from the path of the loading shell. The following shell from the magazine, being retained by the right shell latch, is released by the caroming action of the returning right action bar. At this point the shell is intercepted and held by the left shell latch until the next feeding cycle.

LOCKING.— When the shell is fully in the chamber, the action closes and the bolt is against the shell base. The slide continues to travel within the bolt and cams the locking block into the recoil shoulder of the barrel. The locking block secures the breech bolt firmly and is supported by the slide as it completes its forward travel. With the locking block fully seated, the passage through the locking block allows protrusion of the firing pin through the bolt face.

Maintenance

The following discussion on maintenance of the M870 shotgun will cover only action necessary for routine maintenance of the weapon. Maintenance is performed in accordance with the MRCs for this weapon.

Before any disassembly of the shotgun M870 is attempted, be sure no shells remain in the chamber or magazine.

BARREL.— To remove and clean the barrel, push the safety to the safe position. Open the action, unscrew the magazine cap, and pull the barrel from the receiver. Replace the magazine cap on the end of the magazine tube. To clean the barrel, use a cleaning rod with a lightly oiled cloth. If powder fouling remains in the barrel, use a powder solvent to scrub the bore. After using solvent, wipe the barrel clean and re-oil it very lightly. Replace the barrel by removing the magazine cap, insert the barrel in the receiver, and replace the magazine cap.

TRIGGER PLATE ASSEMBLY.— With the safety pushed to the safe position, cock the action. Tap out the front and rear trigger plate pins. Lift the rear of the trigger plate from the receiver, then slide it rearward to remove it from the gun. The trigger assembly will be cleaned as a unit by brushing with a

solvent. Wipe the trigger assembly dry and re-oil it very sparingly. When replacing the plate assembly in the gun, make sure the action bar lock enters the receiver easily and operated in position.

FORE-END ASSEMBLY UNIT.— Push the safety to the safe position. Close the action, remove the magazine cap and barrel. Reach into the bottom of the receiver and press the left shell latch inward. Remove the fore-end by sliding it forward off the magazine tube. After the fore-end assembly has been removed from the gun, the breech bolt parts and slide may be lifted from the ends of the action bars.

NOTE

The top right edge of the slide may bind on the bottom front edge of the ejector port in the receiver. To free the slide, push downward on the front end of the bolt.

It is not necessary to disassemble the bolt for routine cleaning. Brush it with solvent to clean, then wipe dry.

Assembly of the weapon is done in reverse of disassembly. There are, however, set procedures to follow to facilitate the assembly.

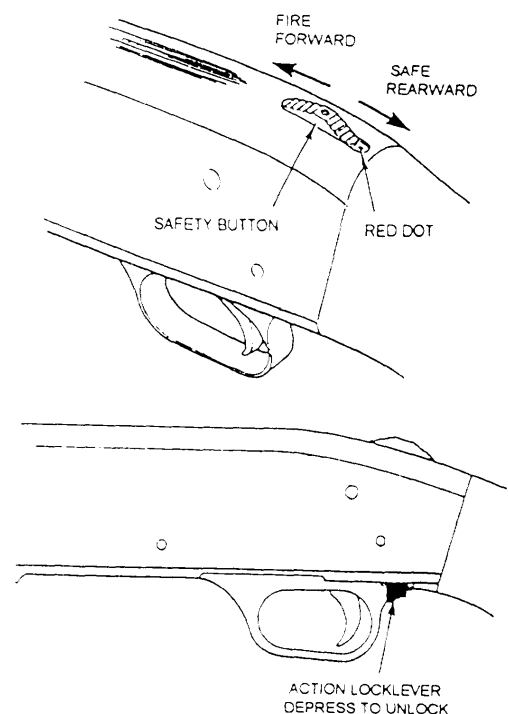

Figure 8-28.—Mossberg M500 shotgun safety and action locklever.

When assembling the fore-end parts, the gun must be cocked. During this assembly, place the slide in the correct position on the ends of the double-action bar. Place the breech bolt assembly, with attached locking block assembly, over the slide on the action bars. Insert the end of the action bars into the matching grooves in the receiver. Move the fore-end slowly until contact is made with the front end of the right shell latch. Press the front right shell latch into the side of the receiver and continue moving the fore-end past this latch until contact is made with the left shell latch. Press the front of the left shell latch in to allow the fore-end assembly to pass and move freely into the receiver. Assemble the barrel to the receiver and tighten firmly with the magazine cap. This completes the assembly of the shotgun.

For further information on the Remington M870 shotgun, refer to U.S. Air Force TM TO-11W3-6-2-1.

MOSSBERG M500 SHOTGUN

While very similar to the M870, the Mossberg M500 has a few significant differences. The following is a brief description of differences that affect operation

of the weapon. Figure 8-28 illustrates the location of the safety button and the action locklever on the M500 shotgun. The M500 safety button is located on the top of the receiver, and the action locklever is to the rear of the trigger guard. But the M870 has the safety button in the trigger guard, and the action bar lock to the front of the trigger guard. The disassembly and maintenance of the M500 is basically the same as that of the M870 so much so that they are both currently covered on the same MRC. Further information on the Mossberg M500 shotgun may be found in the manufacturer's owner's manual supplied with the weapon.

7.62-MM M60 MACHINE GUN

LEARNING OBJECTIVES: List the essential features and describe the operation of the M60 machine gun.

The M60 machine gun (fig. 8-29) is an air-cooled, belt-fed, gas-operated automatic weapon. The machine gun was originally developed for use by

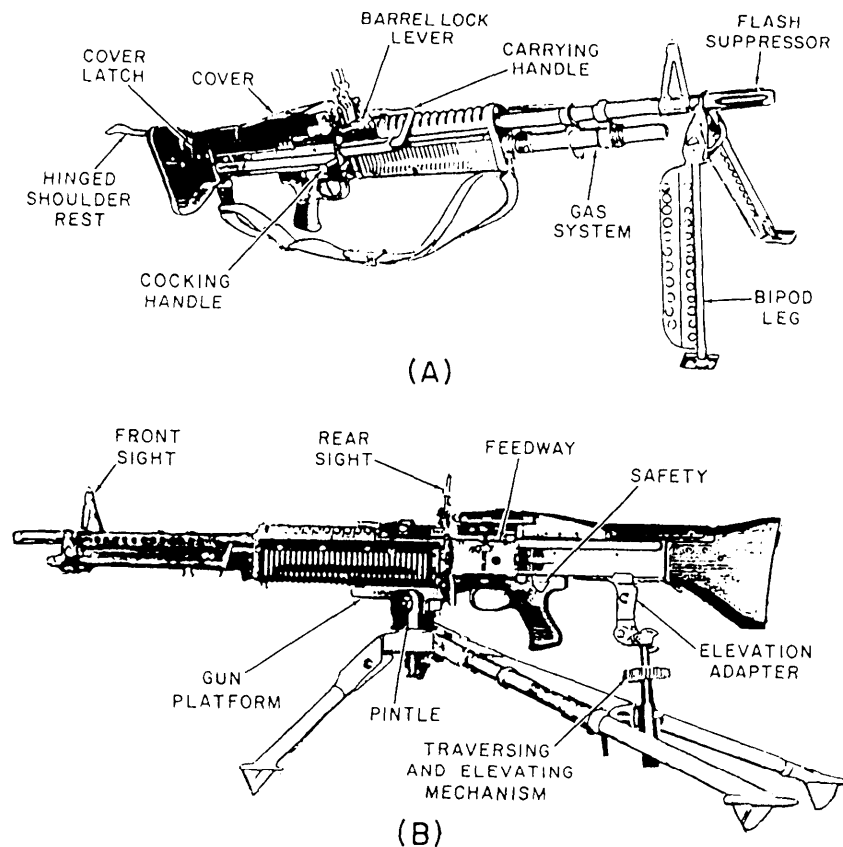

Figure 8-29.—M60 machine gun: (A) Bipod mounted; (B) Tripod mounted.

ground troops; however, it is used on many types and classes of ships, river patrol craft, and combat helicopters.

Essential features of the M60 are as follows:

Length	43.5 in. (110.5 cm)
Weight	23 lb (10.4 kg)
Maximum range	3,725 meters (4,075 yd)
Maximum effective range	1,100 meters (1,200 yd)
Ammunition	7.62-mm ball tracer, armor-piercing, incendiary, and dummy

Rates of fire:

Sustained	100 rounds per minute
Rapid	200 rounds per minute
Cyclic	550 rounds per minute

The M60 has a front sight permanently affixed to the barrel. The rear sight leaf is mounted on a spring-type dovetail base (fig. 8-30). It can be folded forward to the horizontal when the gun is to be moved. The range plate on the sight leaf is marked for each 100 meters, from 300 meters to the maximum effective range of 1100 meters. Range changes may be made by using either the slide release or the elevating knob. The slide release is used for making major changes in elevation. The elevating knob is used for fine adjustments, such as during zeroing. Four clicks on the elevating knob equal a 1-mil change of elevation. The sight is adjustable for windage 5 roils right and left of zero. The windage knob is located on the left side of the sight. One click on the windage knob equals a 1-mil change of deflection.

NOTE

One mil equals 1 inch at 1000 inches, 1 yard at 1000 yards, 1 meter at 1000 meters, etc.

A safety lever is located on the left side of the trigger housing. It has an *S* (SAFE) and an *F* (FIRE) position. On the SAFE position the bolt cannot be pulled to the rear or released to go forward. The cocking lever, on the right side of the gun, is used to pull the bolt to the rear. It must be returned manually to its forward position each time the bolt is manually pulled to the rear.

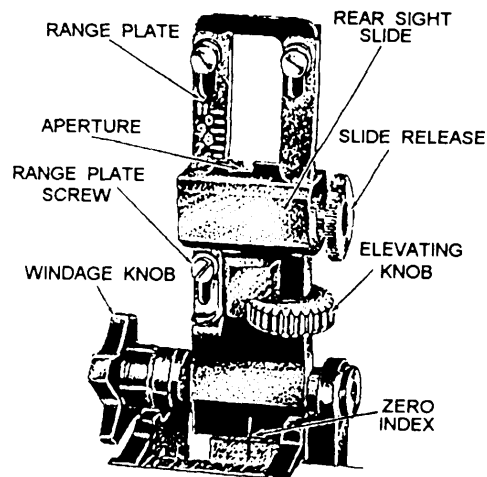

Figure 8-30.-M60 rear sight.

OPERATION

The machine gun is designed to function automatically as long as ammunition is fed into the gun and the trigger is held to the rear. Each time a round is fired, the parts of the machine gun function in a certain sequence. Many of the actions occur simultaneously and are only separated for teaching purposes. The sequence of operation is known as the cycle of operation.

The cycle starts by putting a round in the feed tray groove and then pulling the trigger, releasing the sear from the sear notch (fig. 8-31). It stops when the trigger is released and the sear again engages the sear notch in the operating rod. When the trigger is held to the rear, the rear of the sear is lowered and disengaged from the sear notch. This allows the operating rod and bolt to be driven forward by the expansion of the operating rod spring. Now that the gun is functioning, the steps of the cycle can be traced.

As the bolt begins its forward movement, the feed cam is forced to the right, causing the feed cam lever to pivot in the opposite direction and forcing the feed pawl over the next round in the belt, ready to place it in the feed tray groove when the rearward action occurs again. As the bolt moves to the rear (fig. 8-32) after the firing, the cam roller on the top of the bolt forces the feed cam to the left. The feed cam lever is forced to pivot, moving the feed pawl to the right, placing a round in the feed tray groove.

As the bolt travels forward, the upper locking lug engages the rim of the cartridge. The pressure of the front and rear cartridge guides hold the round so that

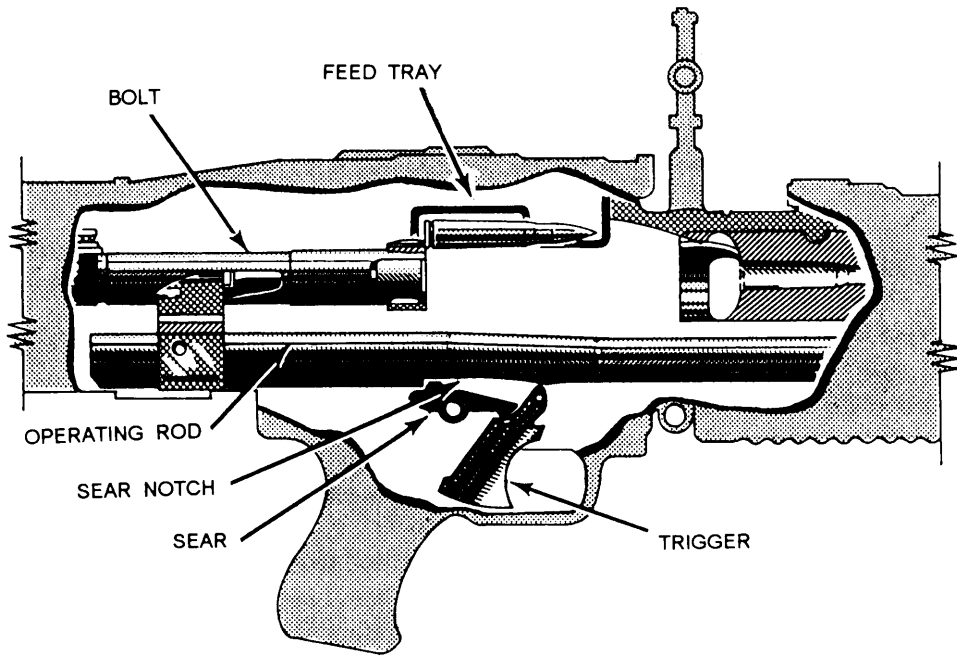

Figure 8-31.-Sear disengaging from sear notch.

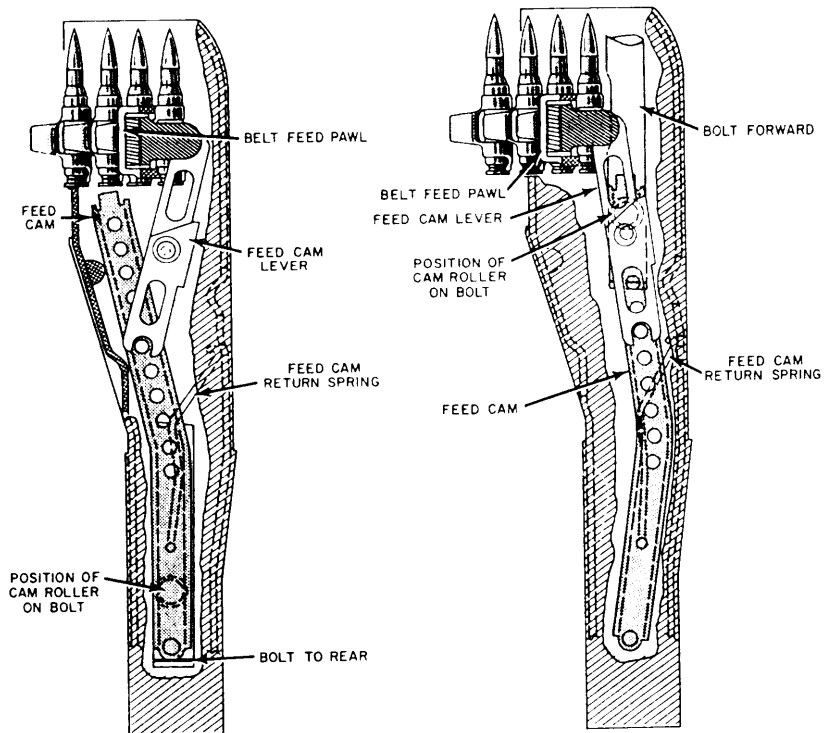

Figure 8-32.-Feeding.

positive contact is made with the upper locking lug of the bolt. The front cartridge guide prevents the link's forward motion as the round is stripped from the belt. The upper locking lug carries the round forward, and the cambering ramp causes the nose of the cartridge to be caromed downward into the chamber as shown in figure 8-33. When the round is fully seated in the chamber, the extractor snaps over the rim of the cartridge, and the ejector on the face of the bolt is depressed.

As the round is chambered, the bolt enters the barrel socket. The upper and lower locking lugs contact the bolt cambering surfaces inside the barrel socket and start the rotation of the bolt clockwise. The action of the operating rod yoke against the bolt cambering slot, as the operating rod continues forward, causes the bolt to complete its one-quarter turn clockwise rotation (fig. 8-34). Locking is then completed.

After the bolt reaches its fully forward and locked position, the operating rod continues to go forward,

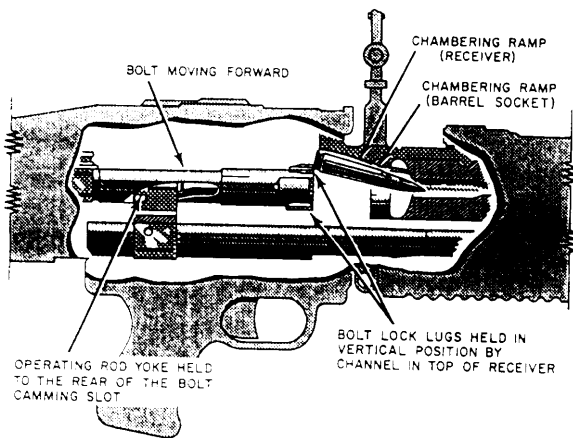

Figure 8-33.-Chambering.

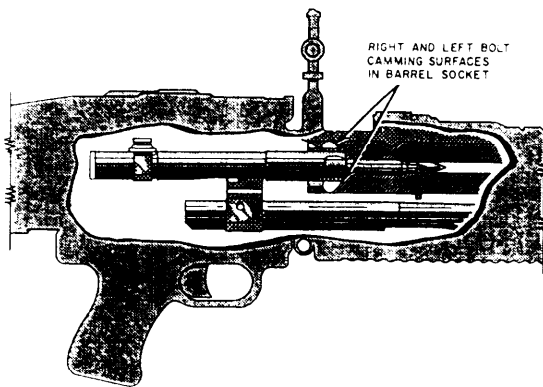

Figure 8-34.-Weapon locked, ready to fire.

independently of the bolt, for a short distance. The yoke, engaged between the firing pin spools, carries the firing pin forward. The striker of the firing pin protrudes through the aperture in the face of the bolt, strikes the primer of the cartridge and detonates it. This action is depicted in figure 8-35.

After the cartridge is ignited and the projectile passes the gas port, part of the expanding gases enter the gas cylinder through the gas port. The rapidly expanding gases enter the hollow gas piston as shown in figure 8-36, and force the piston to the rear. The operating rod, being in contact with the piston, is also pushed to the rear. As the operating rod continues to the rear, the operating rod yoke acts against the bolt camming slot to cause the bolt to begin its counter-clockwise rotation. The upper and lower locking lugs of the bolt, contacting the bolt cambering surfaces inside the barrel socket, cause the bolt to complete its one-quarter turn rotation (counterclockwise) and unlock the bolt from the barrel socket. Unlocking begins as the yoke of the operating rod contacts the curve of the bolt camming slot, and ends as the bolt clears the end of the barrel socket.

While unlocking is going on, extraction is beginning. The rotation of the bolt (in unlocking) loosens the cartridge case in the chamber. As the operating rod and bolt continue to the rear, the extractor (gripping the rim of the cartridge) pulls the cartridge case from the chamber. As the case is withdrawn from the chamber, the ejector spring expands. The ejector presses on the base of the cartridge case, forcing the front of the spent case against the right side of the receiver, as shown in figure 8-37. As the bolt continues to the rear, the action of the ejector pushing against the base of the cartridge case and the extractor gripping the right side of the case cause

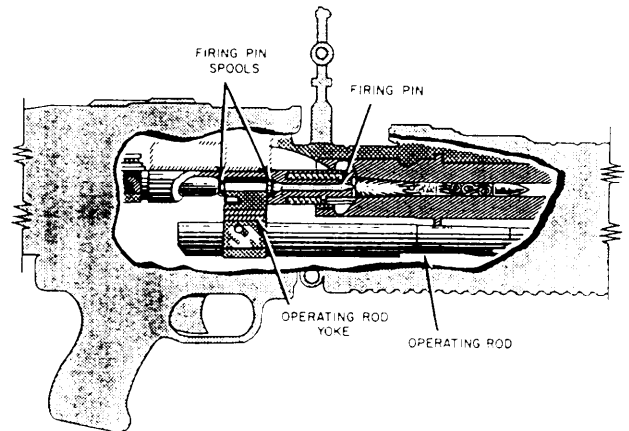

Figure 8-35.—Firing.

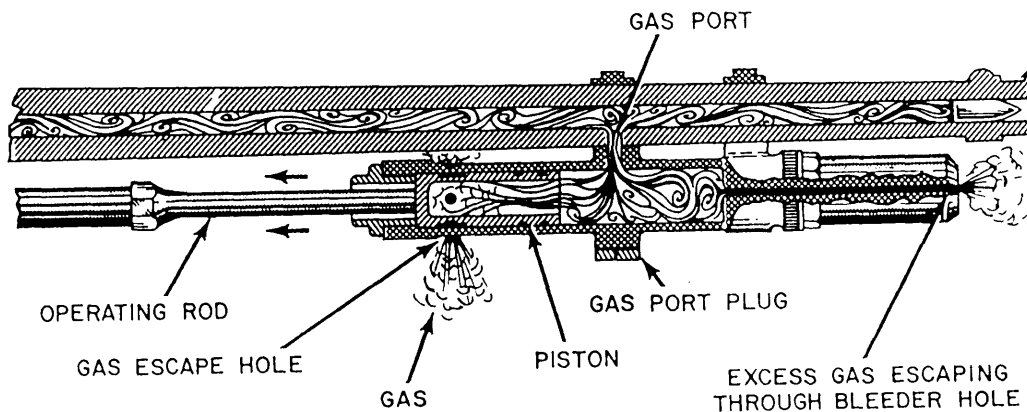

Figure 8-36.-Unlocking action of gases.

the cartridge case to spin from the gun as the case reaches the ejection port. The empty link is forced out of the link ejection port as the rearward movement of the bolt causes the next round to be positioned in the feed plate groove.

As the expanding gases force the gas piston to the rear, the operating rod is initially moved independently of the bolt. The yoke of the operating rod acts against the rear firing pin spool, withdrawing the firing pin from the primer of the spent cartridge case. The action of the operating rod yoke continuing to the rear against the rear firing pin spool fully compresses the firing pin spring. As long as the trigger is held to the rear, the weapon will continue to complete the first seven steps of functioning automatically. When the trigger is released and the sear again engages the sear notch, the cycle of functioning is stopped and the weapon is cocked.

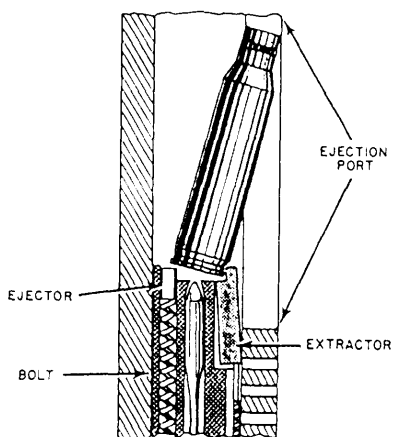

Figure 8-37.—Extraction and ejection.

For further information on the M60 machine gun refer to U.S. Army TM 9-1005-224-24 and TM 9-1005-24-10.

GRENADE LAUNCHERS

LEARNING OBJECTIVES: List the two types of grenade launchers used by the Navy. Describe the controls of the M79 grenade launcher and explain the operating procedure.

The Navy currently uses two types of grenade launchers, the M79 and the Mk 19, Mod 3 machine gun. Both fire a 40mm grenade ammunition. However, the ammunition is NOT interchangeable. The linked rounds for the Mk 19, Mod 3 have a longer casing than those intended for use in the M79. For our purpose we will only discuss the operation of the M79.

40-MM M79 GRENADE LAUNCHER

The M79 grenade launcher (fig. 8-38) is a break-open, single-shot weapon. It is breech loaded and chambered for a 40-mm metallic cartridge case

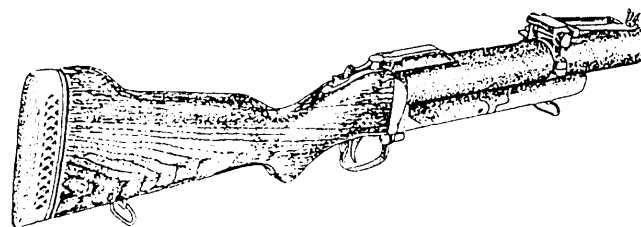

Figure 8-38.—M79 grenade launcher.

with internal primer. Cartridges used with the M79 grenade launcher are shown in figure 8-39.

CONTROLS OF THE M79 GRENADE LAUNCHER

The safety (fig. 8-40) is in the safe position when pulled all the way back and in the firing position when pushed all the way forward.

The barrel locking latch (fig. 8-40), when pushed all the way to the right, permits the breech end of the barrel to be swung up into the open position. The grenade launcher cocks as it opens.

The trigger guard (fig. 8-40) is shown in lowered position. It can be released for setting to one side or the other by pushing back the cylindrical housing at the front. This makes it possible for a person wearing heavy gloves or mittens to fire the grenade launcher. The sighting equipment for the launcher is shown in figure 8-41.

OPERATING THE M79 GRENADE LAUNCHER

The following procedures should be followed when loading and firing the M79 grenade launcher.

Preparation for Firing

Check the bore to be sure that it is free of foreign matter or obstructions. Check all ammunition to be sure proper type and grade are being used. Check for

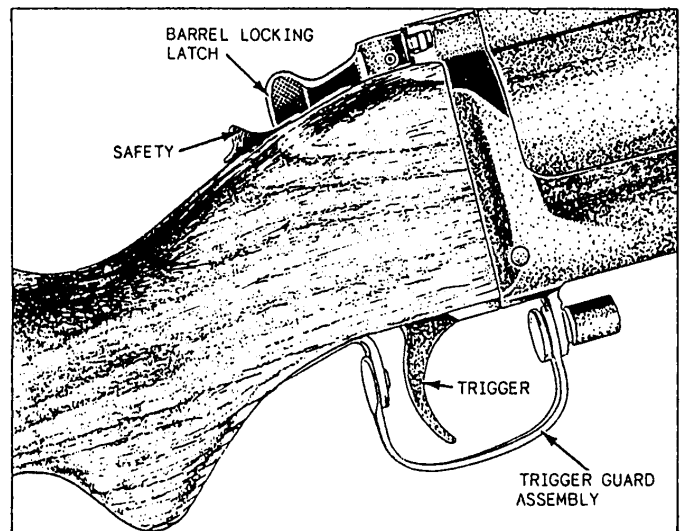

Figure 8-40.-M79 Grenade launcher controls.

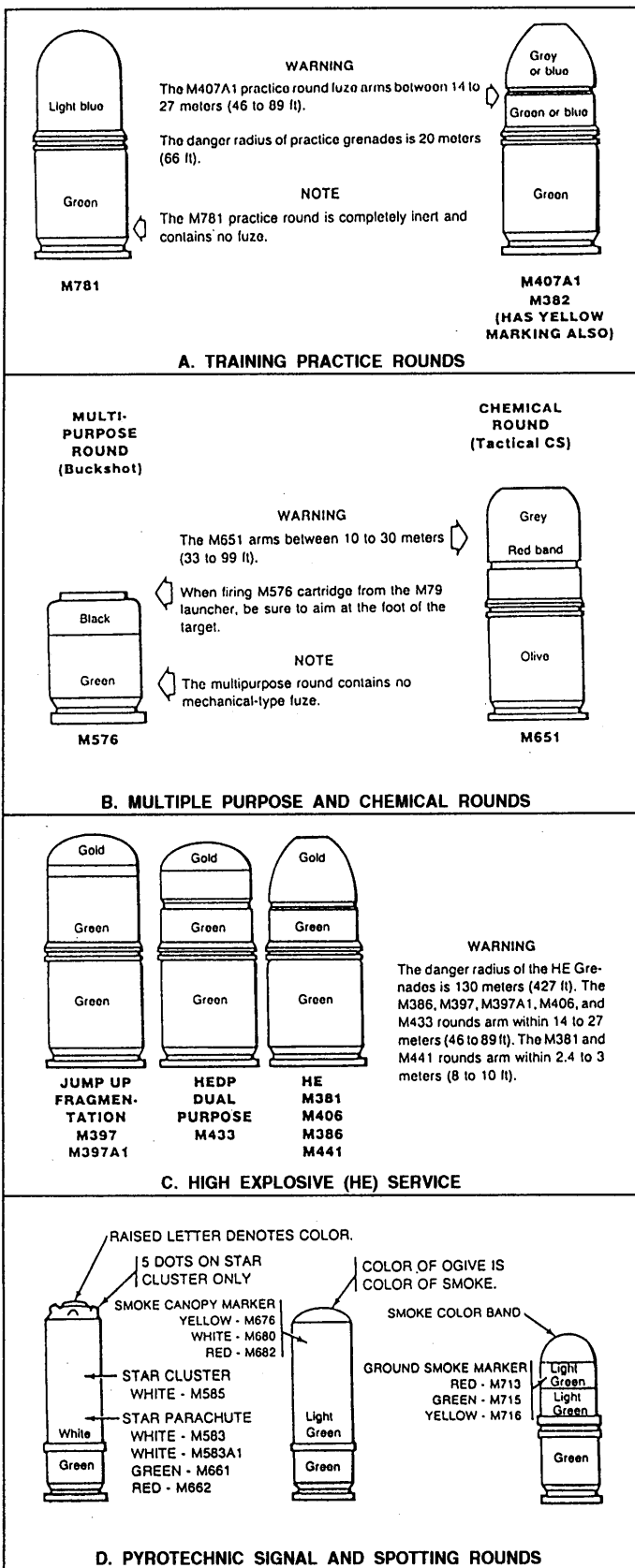

Figure 8-39.-Cartridges used in the M79 grenade launcher: (A) Training practice rounds; (B) Multiple purpose and chemical rounds; (C) High explosive (HE) service; (D) Pyrotechnic and spotting rounds.

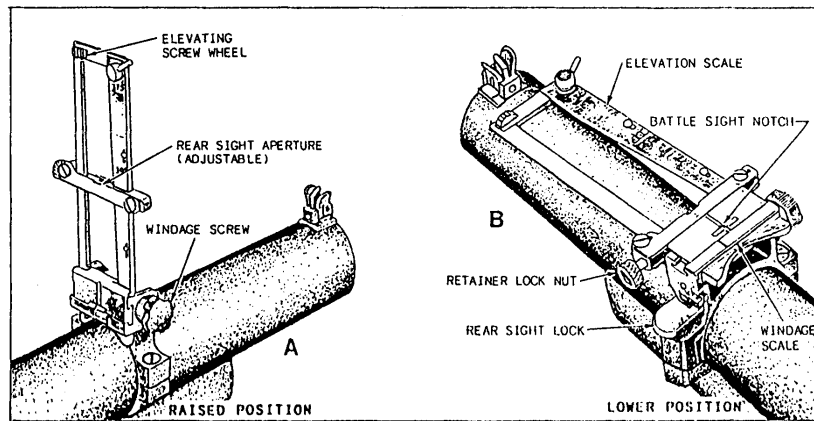

Figure 8-41.—Rear sight assembly.

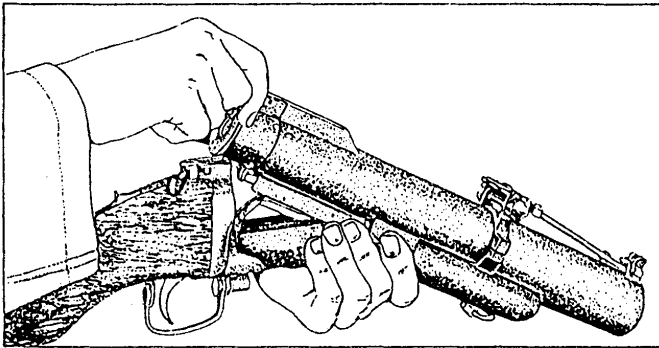

Figure 8-42.—Loading the M79 grenade launcher.

launcher to be sure that it is properly cleaned. Inspect for malfunction and other defects.

Loading

Point the muzzle of the launcher at the ground and clear the area of all personnel.

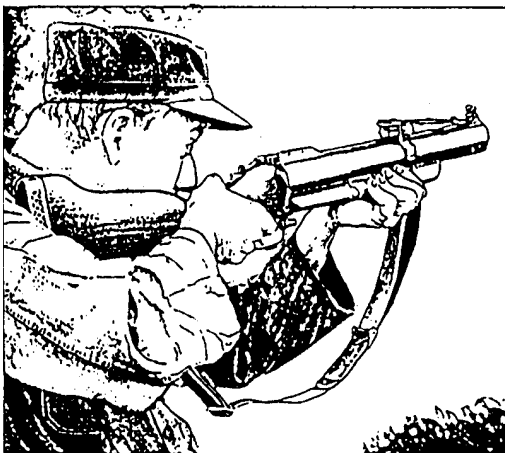

Figure 8-43.—Firing the M79 from the standing position.

Move the barrel locking latch all the way to the right and break open the breech. If the safety is not already on SAFE, this procedure will cause it to move to SAFE provided that the barrel locking latch is moved to its full limit of travel.

Insert the projectile portion of the ammunition into the chamber opening (fig. 8-42) and push the complete round forward into the chamber until the extractor contacts the rim of the cartridge case.

Close the breech.

Firing

When the launcher is fired, you must be in either a standing or prone position. In the standing position, the butt is placed against the shoulder. In the prone position, the butt is placed against the ground. (See figures 8-43 and 8-44.)



Figure 8-44.—Firing the M79 from the prone position.

A detailed discussion of sightsetting is beyond the scope of this course. However, to engage targets at ranges from 50 to 80 meters (165 to 265 feet), the rear sight frame assembly is placed in the lowered (called the "battle sight") position (fig. 8-43). Longer ranges are fired with the rear sight frame in the upright position (fig. 8-41) and the sight aperture bar set at the approximate target range of the scale. TM 9-1010-205-10 provides detailed instruction on use of the launcher's sights.

When firing grenades at targets within battle sight ranges (50 to 80 meters or 165 to 265 feet), the operator must be in a protected position. Targets that are within 80 meters (265 feet) of friendly troops must not be fired upon.

SPECIAL PRECAUTIONS FOR SMALL ARMS

LEARNING OBJECTIVES: Discuss the special precautions that must be observed when handling small arms. Identify and describe 10 safety precautions that must be applied when handling small arms.

Semiautomatic pistols in the hands of inexperienced or careless persons are largely responsible for the saying, "It's always the unloaded gun that kills." It is a fact that many accidental deaths and injuries are due to the mistaken belief that removing the magazine of a weapon is all that is necessary to unload it. Nothing could be further from the truth. To completely unload a weapon and render it safe, you must not only remove the magazine but also make certain the chamber is empty. The only way this can be done is to pull back the slide or bolt and inspect the chamber either visually or, if it is dark, by feel. All weapons must be considered loaded when the slide or bolt is forward and/or the magazine is in the weapon.

Let us review briefly some of the safety precautions that apply to the handling of all small arms:

1. Never point a weapon at anyone or anything you are not ready to destroy.
2. Unless the weapon is to be used immediately, never carry it with a round in the chamber.
3. Unless you are about to fire it, the safety of every small-arms weapon must always be in the SAFE position. Always keep your finger away from the

trigger. When the safety is moved from the SAFE to FIRE position, many small arms will fire if the trigger is pressed as the safety is released.

4. Consider a gun loaded until you have opened the chamber and verified that it is empty. It is not enough to wail, afterward, "I didn't know it was loaded." The empty weapon is the dangerous one.

5. Before firing any weapon, be sure there are no obstructions in the bore.

6. Before firing any weapon, be sure the ammunition you are using is the right ammunition. For example, the M14 ammunition cannot be used in the M 16 rifle. Nor should you try to use illumination signals with shotguns, even though they look much like shotgun shells.

7. Before firing, be sure there is no grease or oil on the ammunition or in the bore or chamber. Although lead bullets may be lightly waxed or greased, there must never be any lubricant on the cartridge case.

8. Keep ammunition dry and cool. Keep it out of the direct rays of the sun. Keep ammunition clean, but do NOT polish it or use abrasives on it. Do not attempt to use dented cartridges, cartridges with loose bullets, or cartridges eaten away by corrosion.

9. Misfires and hangfires can occur with small-arms ammunition as well as with other types. On some weapons like the automatic pistol, you can recock and attempt to fire again without opening the breech. If after a couple of tries this proves unsuccessful, or if the weapon cannot be recocked without opening the bolt, wait at least 10 seconds, then open the bolt and eject the defective round. Defective small-arms ammunition should be disposed of in accordance with current regulations.

A misfire with blank cartridges may leave unburned powder deposited in the bore; always check the bore after any misfire and clean it if necessary.

WARNING

Never try to dislodge a bullet from the barrel by firing another bullet.

10. If you experience a light recoil or report, clear the weapon and check the bore for obstruction. Obstruction may indicate a partial burning of the propellant, which may not have been sufficient to force the bullet clear of the muzzle.

WARNING

DO NOT attempt to operate any small arms or pyrotechnic device until you are thoroughly trained and certified on that device. The information contained in this training manual should not be used to replace source publications or prescribed training procedures.

SMALL ARMS MAINTENANCE

LEARNING OBJECTIVES: Define *preventive maintenance* and explain the importance of preventive maintenance for small arms. List three sources that outline preventive maintenance for small arms.

Preventive maintenance is the systematic care, inspection, and servicing of material to maintain it in a serviceable condition, prevent breakdowns, and assure operational readiness. To maintain your small arms in a state of readiness, you must service them (including lubrication) each time they are used and periodically when in stowage.

The cleaning, preservation, and care given to small arms are determining factors in their operation and shooting accuracy. You have undoubtedly heard that an ounce of prevention is worth a pound of cure. This can aptly be applied to the maintenance of all ordnance weapons and equipment. To properly maintain these weapons, you must use a system of preventive maintenance. Normally, the preventive maintenance procedures are set forth in the 3-M System's maintenance requirement cards (MRCs). TMs and FMs also provide a schedule of maintenance instructions for each weapon.

Inspections of each weapon are an important part of preventive maintenance. Inspections to see if items are in good condition, correctly assembled, secure, not worn, and adequately lubricated apply to most items in preventive maintenance procedures.

STOWAGE AND ISSUE OF SMALL ARMS

LEARNING OBJECTIVES: Explain the importance of proper stowage and issue of small arms. Identify the instruction that contains information on security of small arms.

As an MA, you may be responsible for the security, stowage, and issue of all small arms at a

security department ashore. The increasing number of reported instances of ammunition and weapon pilferage by dissident groups and individuals indicates the necessity for stricter control of storage, security, custodial responsibility, and inventory reconciliation procedures for easily pilfered items, which includes small arms.

Small arms should always be stowed in an authorized and secure stowage to preclude pilferage. A strict accountability must be maintained at all times. OPNAVINST 5530.13, *Department of the Navy Physical Security Instruction for Conventional Arms, Ammunition, and Explosives (AA&E)* contains detailed instructions for the security of small arms and other AA&E materials. This includes access control, key custody, and storage requirements. Since this instruction is subject to frequent changes we will not go into any detail on its contents. However, you are strongly encouraged to become familiar with the specifics of this document and to make its contents the object of frequent training and review in your work center.

Since all small arms are considered equipage, a signature of subcustody is required before they are issued from their normal place of stowage. Any type of signed custody record may be used as long as it bears the receiving individual's signature. Inside your armory you should have a list of personnel who are qualified to be issued weapons. Anyone who is not on that list should not be able to draw a weapon from the armory. A second consideration for issuing small arms is to determine whether or not the requesting person is authorized to draw a weapon at this time. Any out-of-the-ordinary requests for weapons should be prearranged and authorized. When in doubt, call your chief, division officer, or the command duty officer. Again, the important security measures are to keep the weapon locked up and, when it is issued, to determine qualification and authority, and to get a signature.

STORAGE FACILITIES

Access to each storage facility will be limited, to maintain accountability and control of firearms, and the facility will be secured when not under the direct supervision of an authorized custodian. The keys to each lock used to secure firearms also will be controlled. Personnel on duty in arms storage rooms must be armed at all times.

The commander will develop written procedures for control and operation of storage facilities to ensure

that all firearms are accounted for. Unit personnel maintain a list containing the type, model number, caliber, name of manufacturer, and serial number of all firearms for which the unit is responsible. (This list will be useful in making required inventories and rapid identification of lost or stolen weapons.) Current policy and guidance relative to small arms and weapons management may be found in *Small Arms and Weapons Management Policy and Guidance*, NAVSEAINST 8370.2.

MARKSMANSHIP

LEARNING OBJECTIVES: State the primary use of a side arm and describe the three elements of marksmanship. Explain the importance of maintaining small arms qualifications for Master-at-Arms personnel.

The primary use of the side arm is to return quick, accurate fire at close range. Accurate shooting is the result of knowing and correctly applying the elements of marksmanship. The important elements of marksmanship are (1) position, grip and aim, (2) sight alignment, and (3) trigger control.

TRAINING

Marksmanship training is divided into two phases; preparatory marksmanship training and range firing.

These two phases may be divided into separate instructional steps. All marksmanship training must be progressive.

A thorough course in preparatory marksmanship training must precede any range firing. This training must be given to all Masters-at-Arms expected to fire the side arm on the range, including those who have previously qualified with the weapon. The MA should develop correct shooting habits before range firing. The purpose of preparatory marksmanship training is to establish correct shooting habits.

Preparatory marksmanship training should be taught as follows:

1. Positions.
2. Proper grip of the weapon.
3. Sight alignment.
4. Trigger control.

AIMING

Proper aim is achieved through correct position and grip. Aiming is the relationship of the firer's position and weapon to the target. When assuming a position, the firer's body and weapon must be aligned to the target. Proper grip of the weapon is essential to ensure that the aim of the weapon is in line with the firer's alignment to the target.

A proper grip is one of the more important fundamentals of quick fire. The pistol is gripped as tightly as possible until the hand begins to shake. The grip is then relaxed until the tremor stops. At that point, the firer is applying the necessary pressure for a solid grip. With practice, the same amount of pressure will be applied each time the firer assumes the grip.

Sight alignment is the relationship of the front sight to the rear sight. Correct sight alignment is having the front and rear sights level, with the front sight being centered in the rear sight. Perfect sight alignment is virtually impossible, since the front sight is continually moving. The object is to maintain the front sight level and centered with the rear sight as closely as possible, which holds the weapon within the area of aim. When you are sighting, the eye cannot focus on three objects (rear sight, front sight, target) at different ranges. Therefore, the focus should be on the front sight through the rear sight. The front and rear sights will be seen clearly and sharply while the target will appear to be a bit hazy. The bullet will strike the target within the area of aim if the sight has been aligned correctly. Since it is impossible to hold the weapon perfectly still, the shooter must understand that he or she must apply trigger control and maintain correct sight alignment while the weapon is moving in and around the target. This movement of the weapon is referred to as "arch of movement." The shooter must make an effort to keep movement of the weapon to a minimum.

Correct sight alignment is essential for accuracy, particularly with the side arm because of the short sight radius. For example, if a 1/10-inch error is made in aligning the front sight in the rear sight, the bullet will miss the point of aim by about 15 inches at 25 meters of range. The 1/10-inch error in sight alignment magnifies itself as the range increases; at 25 meters it is magnified 150 times.

If the firer does not call the shot correctly in range firing, he or she is not concentrating on sight alignment; consequently, the firer does not know what

the sight picture is while firing. To *call the shot* is to state where the bullet should strike the target according to the position of the front sight at the instant the weapon fires; for example, "high," "a little low," "to the left," "to the right," or "center target."

It is important to emphasize that holding the breath properly is necessary to good marksmanship. Emphasis on this point is required because many persons hold their breath improperly or not at all. The breath should be held while the firer is aiming and applying trigger pressure. While the procedure is simple, it requires explanation, demonstration, and supervised practice. To hold the breath properly, the firer inhales an ordinary breath, lets a little out, and holds the rest by closing the throat.

TRIGGER CONTROL

Poor shooting is generally caused because the aim is disturbed before the bullet leaves the barrel of the weapon. This is usually the result of the firer's jerking the trigger or flinching. The trigger does not have to be jerked violently to spoil the aim; even a slight off-center pressure of the finger on the trigger is enough to cause the weapon to move and disturb the firer's sight alignment. Flinching is a subconscious reflex caused by the firer's anticipating the recoil of the weapon. Jerking is an effort by the firer to fire the weapon at the precise time the sights align with the target. Flinching and jerking will cause the bullet to hit the lower left section of the target for a right-hand shooter. Heeling is caused by a firer's tightening the large muscle in the heel of the hand to keep from jerking the trigger. A firer who has had difficulty with jerking the trigger will attempt to correct the fault by tightening the bottom of the hand, which results in a heeled shot. Heeling will cause the bullet to hit on the top-right section of the target. The firer can correct these shooting errors by understanding and applying correct trigger control. Correctly applied trigger control imparts no unnecessary movement to the weapon. Improper trigger control causes more misses

on the target than any other single step of preparatory marksmanship training.

To apply correct trigger control, the trigger finger may contact the trigger anywhere from the tip of the finger to the first joint, depending on the length of the trigger finger. If pressure from the trigger finger is applied to the right side of the trigger or weapon, the strike of the bullet will be to the left. That is due to the normal hinge action of the fingers. When the fingers of the right hand are closed, as in gripping, they hinge or pivot to the left. (With the left hand, this action is to the right.) The firer must exercise care in the control of the trigger, so as not to apply pressure left or right but straight to the rear.

QUALIFICATIONS

All Master-at-Arms personnel must maintain small arms qualifications. The guidance for qualification and proper range procedures can be found in the *Law Enforcement Manual*, OPNAVINST 5580.1, *Physical Security Manual*, OPNAVINST 5530.14 and *Small Arms Training and Qualification*, OPNAVINST 3591.1. MAs failing to maintain these qualifications may face removal from the MA rating.

SUMMARY

In this chapter, we defined the term *small arms*, explained small arms nomenclature, and looked at the small arms cycle of operation. Next, we covered firing systems, basic types of operation for small arms, and range and rates of fire. The Navy's two standard handguns, the .45-cal pistol and the .38-cal. revolver, were then considered. The M14 and M16 rifles, shotguns, and the 7.62-mm M60 machine gun were examined, followed by grenade launchers and special safety precautions. Then we looked at pyrotechnics, pyrotechnic safety, and small arms maintenance. Finally, we covered stowage and issue of small arms and the elements of marksmanship.

CHAPTER 9

CROWD CONTROL

Masters-at-Arms may be called upon at any time to restore order in a variety of circumstances. These will range from unruly behavior of a group of sailors aboard ship to a major civil disturbance that has exceeded the control capabilities of civilian police and other authorities. MAs may also be required to control large groups of people as part of a disaster relief operation. In this chapter, we discuss the nature of crowds and their behavior. Then we discuss the composition and capability of a *crowd control force*- the personnel assigned to control the crowd. The principal techniques used in crowd control will also be examined.

CIVIL DISTURBANCES

LEARNING OBJECTIVES: Describe the role of the Attorney General and the Attorney General's senior representative regarding civil disturbances. Identify the executive agent in all matters pertaining to civil disturbances. Explain the purpose of intervention and two categories of intervention.

The Attorney General of the United States is responsible for coordinating all Federal Government activities relating to civil disturbances. When a civil disturbance is imminent or active and it appears that Federal assistance may be required, the Department of Justice may send an observer to that area to assess the situation and make appropriate recommendations. This representative is designated the Senior Representative of the Attorney General (SRAG). The SRAG is the coordinator of all Federal liaison with local civil authorities. One of the principal functions of the SRAG is to keep the Attorney General informed of all aspects of the situation.

EXECUTIVE AGENT

The Secretary of the Army has been designated the Executive Agent for the Department of Defense in all matters pertaining to a civil disturbance. The Department of the Army has principal responsibility for coordinating the functions of all military services. However, the Navy may be called on to assist or to

handle the task alone. DOD directive 3025.10 outlines the Navy's responsibilities during a civil disturbance.

INTERVENTION

The purpose of intervention in a civil disturbance is to restore order and to permit local authorities to function properly. Bloodshed and the destruction of property must be avoided, when possible, and the minimum amount of force necessary to accomplish the mission should be used. The local commander publishes rules for the local population until order is restored.

Intervention falls into two categories: military aid to civil authorities, and martial law. Martial law is actually a temporary Government function to restore order within a country or locality. In either situation, the duties of the Armed Forces are much the same. Rarely has our Government proclaimed martial law. Military aid to civil authority is preferred.

COLLECTIVE BEHAVIOR

LEARNING OBJECTIVES: Describe collective behavior and list the two factors involved. Discuss collective behavior in crowds and define two types of crowds. Define a mob and its characteristic behavior. Explain four situations in which collective behavior relates to civil disturbances.

For the purpose of this chapter, the term *collective behavior* refers to the actions of a group of individuals in situations in which normal standards of conduct may not be practiced, such as in crowds, mobs, and civil disturbances.

Collective behavior involves both psychological and social factors, and some of these are evident in everyday life. People participate daily in group situations without designated social rank. But when these elements are combined and collective behavior takes on dramatic form, concerns are raised.

While collective behavior may appear to be spontaneous and unpredictable, it is not purely a matter of chance. There is invariably an underlying motivation

or goal for mob action or a civil disturbance. Now let's look at collective behavior in crowds, mobs, and civil disturbances.

CROWDS

The crowd is the most common form of collective behavior. A crowd is defined as a large number of persons temporarily congregated. Just as in all other forms of collective behavior, a crowd is more than just a collection of individuals. Simply being a part of a crowd affects an individual to some degree, causing him or her to act differently than when alone. For example, a very mild and submissive person may find courage within a crowd to commit acts that the person would be hesitant to attempt alone.

There are almost as many types of crowds as there are reasons for persons to assemble. The audience that assembles for a football game or gathers at an accident is a *casual crowd*. Individuals within this crowd probably have no common bonds other than the enjoyment or curiosity that the game or incident stimulates. There is also a *planned crowd*, one that assembles at the call of leaders to accomplish a purpose in which all members have an interest and purpose. Numbers enhance the probability of success.

Under normal circumstances when a crowd is orderly, is not violating any laws, and is not causing danger to life or property, it does not present a problem to authorities. But crowd violence usually results when people have grievances, either real or imagined. The crowd is led to believe that violence will achieve redress.

MOBS

The extreme of crowd behavior is called a mob. A *mob* is a crowd whose members lose their concern for laws and authority and follow their leaders into unlawful and disruptive acts. Mob behavior is highly emotional, often unreasonable, and prone to violence. A mob can be developed from almost any crowd if proper conditions are present. The planned crowd lends itself to influence by its leadership, peaceful or otherwise. In fact, skillful agitators in today's society, through use of television, radio, and other communications media, can reach large portions of the population. The agitators incite individuals to unlawful acts without the need for a pre-formed crowd or direct personal contact with the crowd.

CIVIL DISTURBANCES

In a civil disturbance environment, any crowd represents a threat to law and order because a crowd can be easily manipulated by skillful agitators and create a capacity for violence.

Collective behavior as it relates to civil disturbances is characterized by the following situations:

- Curious bystanders and sympathetic onlookers join forces with activist groups and individuals.
- Crowds that are normally peaceful become irrational mobs as behavior factors take hold.
- Skillful leaders, through various techniques, agitate and incite crowds into irrational action.
- Crowds demonstrate grievances by transferring aggression from social or economic problems to some group or individual, who becomes an object of hostility.

Remember, in order to successfully accomplish civil disturbance control, you must have an understanding of collective behavior and the patterns of disorder involved. The psychological influences on collective behavior are also a factor.

PSYCHOLOGICAL INFLUENCES ON COLLECTIVE BEHAVIOR

LEARNING OBJECTIVES: Identify and explain five psychological influences on collective behavior. Describe how these influences affect both group and control force behavior.

Psychological influences contribute to the irrational extremes of behavior in groups, and control force members are also affected by these same factors. These influences must be considered in planning and training for a disturbance, and in control and supervision after arriving at the disturbance site. Anonymity, impersonality, suggestion and imitation, emotional contagion, and release from repressed emotions are the psychological influences to be considered.

ANONYMITY

Crowds are anonymous because they are large and most often temporary. A crowd member acts with a sense of safety, feeling a part of a faceless mass. The

individual acts without conscience, thinking that moral responsibility has been shifted to the crowd.

The size of the control force and the nature of interaction with the dissidents may remove the sense of individual responsibility from control force personnel as well. This feeling of anonymity may also cause a control force member to commit acts normally suppressed. The commander must assure that supervisors instruct the control force so that these anonymous feelings are prevented. Every leader should know each member of the control force by name, and address each by name at every opportunity.

IMPERSONALITY

Collective behavior is impersonal. In a race riot, for example, individual distinctions are not made. Each member of a certain race or ethnic group is considered to be as good or bad as other members of the same race or ethnic group.

Impersonality affects members of the control force in the same manner it affects the crowd. It could cause the control force to respond to a situation inappropriately because the response would be based on who was involved rather than on what took place. Racial and ethnic balance within the control force itself can help stem impersonality, as can an understanding of the people involved in the disturbance.

SUGGESTION AND IMITATION

A large number of people in a disturbance discourages individual behavior and makes individuals act readily to suggestion. The urge to do what others do is a strong instinct; they look to others for cues and disregard personal background and training. Only individuals with strong convictions can resist the compulsion to conform to the group.

In the confrontation environment, control force personnel also are susceptible to suggestion, and may imitate the actions of others. In such a situation, one improper action may be imitated by others in the control force and cause a broad reaction that may be inappropriate to the situation.

EMOTIONAL CONTAGION

The most dramatic psychological factor in crowd behavior is emotional contagion. Excitement is transmitted from one person to another and a high state of collective emotion builds up. Ideas conceived by the leaders and dominant members of the crowd are rapidly

passed from person to person. These ideas and general mood of the crowd sweep to bystanders and curiosity seekers who are caught in the wave of excitement and crowd action. Emotional contagion is especially significant in a civil disturbance environment for the following reasons:

- Emotional contagion provides the crowd with psychological unity. This unity is based on common emotional responses and is usually temporary, but it may be the only momentum a crowd needs to turn to mob action.
- When emotional contagion prevails, self-discipline is usually low. Individuals disregard normal controls and give way to raw emotions.
- Emotional contagion exceeds the bounds of personal contact. Crowds can also be stimulated by television, radio, and the print media.
- Emotional contagion narrows the field of consciousness and diminishes the critical thinking ability of the control force, as well as that of the crowd. Control force personnel are apt to be emotionally stimulated and be affected by rumor and fear because of the tension in the confrontation environment. When the control force is affected by this tension factor, self-discipline tends to be low and the individual may feel free of normal restraints. Supervisors must be cognizant of this factor and be prepared to take appropriate action to counteract its effects.

RELEASE FROM REPRESSED EMOTIONS

The prejudices and unsatisfied desires of the individual, which are normally held in restraint, are readily released in a mob. This temporary release is a powerful incentive for a person to join in a mob action because it affords an opportunity to do things he or she would normally never do.

Control force members who foster contempt for certain people or segments of society may take advantage of their position to express their contempt. All control force members should be thoroughly briefed about performing duties fairly and impartially, and they must be made aware that they can be held individually accountable for their actions.

FACTORS THAT AFFECT CROWD BEHAVIOR

LEARNING OBJECTIVE: List and explain five factors that affect crowd behavior.

In addition to the psychological influences on behavior, additional factors have been identified that affect group behavior. These factors include emotional needs, moral attitudes, crowd leadership, the use of physical stimuli, and external controls. However irrational and unrestrained crowd behavior may appear, it is ruled by these factors.

EMOTIONAL NEEDS

Crowd behavior expresses the emotional needs, resentments, and prejudices of the members. The emotional stimulus and protection of the crowd encourages its members to express the impulses, hostilities, aggressions, and rages that they restrain in calmer moments. When members of a mob are blocked from expressing emotion toward one another, the mob's attention generally shifts in another direction.

MORAL ATTITUDES

Crowd behavior is limited by the conviction of the members as to what is right. The concept of what is right is based on the customs or folkways, the conventional behaviors, and the moral attitudes of the times and places in which people live. A crowd rarely does anything without some moral approval. A lynching will occur only where a large proportion of the people feel that it is morally justified. The members of a lynching party consider themselves public benefactors, not guilty lawbreakers.

CROWD LEADERSHIP

Leadership profoundly affects the intensity and direction of crowd behavior. A skillful agitator can convert a group of frustrated, resentful people into a vengeful mob and direct their aggression at any target included in their resentment. Likewise, an individual can sometimes calm or divert a crowd by a strategic suggestion or command. In many crowd situations, the members, frustrated by confusion and uncertainty, want to be directed. The first person who starts giving clear orders in an authoritative manner is likely to be followed. At this stage of crowd development, radicals can take charge and exploit the crowd's mood and turn it toward a target of convenience. On the other hand, a

leader may calm the crowd, appeal to the reasoning powers of the individuals present, and avoid a potentially dangerous situation.

THE USE OF PHYSICAL STIMULI

professional agitators may resort to the use of physical stimuli in the form of drugs and liquor to create a false sense of bravado, recklessness, and desperation among selected neighborhood residents. These individuals are encouraged to set up and perpetrate violent acts in their own neighborhood while the professional joins the crowd and cheers them on from the outskirts. This technique is difficult to cope with, because the crowd will be in sympathy with a neighbor. A show of force by authorities often will compound the violence.

EXTERNAL CONTROLS

Weather is an important external control. Crowds usually form in the summertime when people are able to gather in large outdoor assemblies. Cold weather and rain discourage group actions.

Local government is also an external control that affects crowd behavior. Crowd behavior seldom becomes violent when the local government is prepared to cope with the situation before it gets out of hand. Police also have a strong influence on crowd behavior.

Most of these factors that affect group behavior can be applied to situations in a Navy environment, both ashore and aboard ship, particularly aboard larger ships such as carriers.

PANIC

LEARNING OBJECTIVES: Explain how panic affects group behavior. Describe five situations that cause panic and explain two methods used to prevent panic. Identify the most important consideration in preventing panic.

Panic is a factor that must always be considered in crowd control. It results from terror, which inspires unreasoning and frantic efforts to seek safety. Panic is extremely contagious and spreads rapidly. The reactions of people become so irrational that they endanger themselves and others.

CAUSES OF PANIC

The following situations are causes of panic:

- Perceived threat. This is the knowledge or feeling that danger threatens. Usually the danger is felt to be so close at hand that the only course of action is to flee.
- Partial entrapment. The escape routes are limited. Often only one escape route exists.
- Partial or complete breakdown of the escape route. The already limited exits are further blocked or congested. Passage is limited and slow, or even halted.
- Front-to-rear communications failure. When people at the rear of the crowd continue to assume the escape route is open after it is blocked the panic situation is completed. The physical force of people in the rear trying to force their way to the blocked exit causes those in the front to be crushed, smothered, or trampled.
- Massed mob exposure to riot control agents. In a heavily massed configuration, individuals within the mob will be unable to readily escape riot control agents. Their sudden exposure to any significant quantity of a riot control agent may result in a panic situation that may seriously injure large numbers of people.

PREVENTION OF PANIC

Take every precaution to prevent panic. The most important consideration in preventing panic is to keep the people informed. If people can be convinced that no threat exists, or be kept fully informed as to the nature of the existing threat, it is less likely that panic will occur. Always maintain a means of communication with the people.

Another important factor in preventing panic is the establishment of avenues of escape. Ensure these escape routes are well publicized and are clearly defined. Control movement along the avenues of escape so that the flow is channeled in the desired direction. When dispersing a crowd, remember that actual physical blockage of escape routes is not necessary to create panic; the same effect will result if the crowd has cause to believe that escape routes are blocked.

COURSES OF MOB ACTION

LEARNING OBJECTIVES: Describe some of the indiscriminate acts that might occur during a mob action, and list the factors that determine the degree of violence. Describe five incidents that a mob might take against a control force.

Regardless of the reason for violence, whether it is the result of spontaneous reactions or is deliberately incited, riotous actions can be extremely destructive. Such actions may consist of indiscriminate looting and burning, or open attacks on officials, buildings, and innocent passersby. Participants are limited in their actions only by their ingenuity, the training of their leaders, and the weapons, supplies, equipment, and materials available to them. The degree of violence will depend upon a number of factors, such as the type and number of people involved, location, cause of the disturbance, and weapons available. Certain types of violence can be anticipated. The control force must be familiar with and carefully trained in the proper actions to take when incidents such as the following occur:

- Verbal abuse in the form of obscene remarks, taunts, ridicule, and jeers. The purpose of this tactic is to anger and demoralize civil disturbance control forces and cause them to take actions that later might be exploited as acts of brutality.
- Groups of rioters venting their emotions upon individuals and unit formations. Personnel performing duty during a civil disorder might be beaten, injured, or killed. Vehicles might be overturned, set on fire, have their tires slashed, or be otherwise damaged. The same type of violence may be directed against personnel and equipment of fire departments and other public utilities.
- Selective sniping or massed fire that may come from within the ranks of the rioters or from buildings or other adjacent cover. The weapons used will vary from homemade one-shot weapons to sophisticated automatic weapons.
- Women children, and elderly people might be placed in the front ranks. This is done to play on the sympathy of the control forces and to discourage countermeasures. Where countermeasures are undertaken, agitators may have photographs taken to create further public animosity and embarrassment to the control forces.

- The crowd may construct barricades of vehicles, trees, furniture, fences, or any other material that may be in the vicinity. This is done to impede movement or in an attempt to prevent control forces from entering an area or buildings.

MANAGEMENT OF CIVIL DISTURBANCES

LEARNING OBJECTIVES: Describe five situations that apply to the management of civil disturbances. State the ultimate and interim objective in the management of civil disturbances, and list six elements that may make it necessary to seek an interim objective. Explain the importance of communications when dealing with a dissident element.

Civil disturbances have been thought of exclusively as riots. This concept has had a direct bearing on the planning, training, and operations of civilian and military control forces. However, the term *civil disturbances*, with its connotation of illegal activity, is sometimes used to include a broad range of confrontations that vary in intensity and purpose from a peaceful assembly in a public place to a violent and destructive attack on people and property. This broad range of activities requires that agencies develop responses based on the variable nature of the threat and provide for a high degree of flexibility and selectivity.

The past emphasis on the violent aspects has often resulted in control force responses that could, or did, aggravate rather than reduce the problem. Some demonstrations, such as *picketing* or *marches*, usually conducted as authorized by a permit, are legitimate forms of protest and generally should not be classed as disturbances. However, the possibility exists that a clique within the group of demonstrators, or factions not connected with the group, will take advantage of the opportunity to escalate the occasion to higher levels of disorder. Therefore, the management of a civil disturbance must be based on the peculiarities of each situation. These situations are as follows:

- Mass demonstrations - involving hundreds or thousands of people, many of whom may be nonviolent and within their rights to protest, but because of their number can overwhelm the capabilities of law enforcement agencies.
- Civil disobedience - often involving elderly women, young females, and mothers with small

children, as well as men whose nonviolent nature places the control forces in an awkward position.

- Idealistic protests - involving fanatically dedicated young participants for whom normal deterrents such as the threat of arrest or use of force has limited or no effect.
- Dispersed riots - involving many small groups of dissidents, many of whom are acting irrationally out of sheer frustration and bitterness. These groups may operate independently or in concert over a wide urban area, dispersing when threatened by control force operations, later reassembling elsewhere.
- Terrorism - involving extremely violent, often radical tactics, such as sniping and bombing attacks, which make conventional police operations extremely hazardous, and probably ineffective.

ULTIMATE OBJECTIVE

The military's ultimate objective in the management of civil disturbances is the restoration of law and order. *Law and order* is a relative term that can generally be equated to a state of normalcy in the community. This objective should include pursuing a course of action that contributes to the long-term maintenance of orderliness. Avoid control force action that accomplishes immediate control only at the price of increased social hostilities and potentially greater future violence.

INTERIM OBJECTIVE

In many civil disturbances, full control cannot be attained immediately. The control force must reduce the intensity of the disturbance to the lowest level that can be realistically attained given all the conditions and variables influencing that particular situation. This interim objective is essentially a compromise. On the one hand, the control force must avoid attempting to impose a degree of control beyond its actual capabilities or through provocative measures of force. On the other hand, the control force must take effective action to attain an acceptable degree of security and the continued functioning of the threatened community. Elements that may influence or necessitate the decision to seek an interim objective are the following:

- Magnitude of confrontation. The size or extent of many disturbances may make the enforcement of all laws impossible in affected areas.

- Readiness of police. In the initial stages of a confrontation, the capability of control forces will be fairly limited pending the assembly of additional forces and the erection of field facilities.
- Time of day. During certain hours of the day, large numbers of bystanders or hangers-on can be expected to be present at a confrontation, making their potential involvement an important factor.
- Intensity of emotions. Where the emotional involvement of confrontation participants is at such a high point that any aggressive action could trigger greater violence.
- Sympathies of public. Certain demonstrations or activities may attract the sympathy of a major segment of the community, thus making the actions of the control forces subject to very close scrutiny.
- Strategy. In many confrontations, the demonstrator's goal is to produce an overly dramatic and violent police response, and the need to thwart that strategy is therefore a factor.

IMPORTANCE OF COMMUNICATIONS

The primary factor that contributes to the reduction of intensities is the existence or establishment of communication between the control force leadership and the leadership of the dissident element. Such communication may be directed through a third party.

The presence of communication enables the control force leadership to seek a reduction of dissident activity short of employing direct force. Communication also minimizes misconceptions of each party by the other, and reduces the possibility of improper or escalating responses by either party due to the misunderstandings of the intentions and capabilities of the other party.

PRINCIPLES OF CIVIL DISTURBANCE CONTROL

LEARNING OBJECTIVE: Identify and explain the seven principles in successfully controlling a civil disturbance.

Past experience in civil disturbance control operations has identified seven principles of greatest value and broadest application in successfully

controlling a civil disturbance. The principles have no order of priority of application. With one exception, the degree of importance of each varies according to the particular circumstances of a specific disorder. The exception is the principle of minimum force, which is applicable in full measure to each disturbance situation. Now let's look at the seven principles that apply to civil disturbance control.

THREAT AWARENESS

The successful and efficient employment of military forces is vitally dependent on timely and accurate information. Too often, however, the analysis of potential disturbances has been based on organization intentions, and activities of the leaders of the demonstration. In this respect, responses have been based on the perceived intentions and activities of the more vocal and militant but much smaller element, without proper consideration of the reaction of the numerous, more peaceful participants or onlookers to such a response. Additionally, equal attention must be given to an appraisal of how the affected community will respond to likely demonstrators' actions and to the reactions of control forces. If the control force reacts in a manner that alienates the people in the community, the intensity of the disturbance could be increased.

PROFESSIONAL IMAGERY

In many civil disturbance situations, the demonstrators and the control force are, in effect, competing for the sympathy of the general public. The demonstrators seek to increase participation in the disturbance; the control force seeks to prevent the involvement of the general public. The establishment of a favorable professional image by the control force that would weigh public sympathy in their favor is a great advantage. Conversely, an unfavorable or unpopular image would increase the control force's problems and contribute to the aims of the dissidents. A favorable control force image is established by skillful performance of duty, discipline, and courtesy.

COORDINATED PREPARATION

Many civil disturbances involve control forces from a variety of municipal, county, state, and federal law enforcement and military organizations. The success and efficiency of these diverse forces are dependent upon their working in harmony and mutual support towards common objectives.

OPERATIONAL UNITY

The employment of diverse control forces from different governmental jurisdictions poses distinct supervisory problems. Unlike conventional military operations under unified command, civil disturbance operations may have no single commander with the requisite authority to direct all control forces. Where unity of command cannot be achieved, cooperation should be sought through such means as assigning operational centers, integrating communications systems, and delineating organizational responsibilities.

PUBLIC ACCEPTANCE

Inherent in civil disturbances is the possibility that certain actions by the control force may not be accepted by the general public. This may cause uninvolved bystanders to support the demonstrators, thereby increasing the intensity of the demonstration. Recognizing these possibilities, control forces must avoid actions that tend to produce greater harm than benefit. The actions chosen to reduce the intensity of the situation require that consequences, both immediate and long-range, be considered to ensure that unnecessary actions offensive to the community are avoided.

NEUTRALITY

The objective of civil disturbance control is the restoration of law and order, not the imposition of punishment or the suppression of peaceful dissent. The conduct of the control forces must be emotionally objective and politically neutral, despite whatever personal feelings or political beliefs they hold as individuals. This outward display of objectivity-neutrality is particularly important where the demonstrator's actions are expressly designed to provoke the type of personal, unlawful control force reaction that would create greater support for the demonstrators.

MINIMUM FORCE

The commitment of military forces to support civilian law enforcement agencies must be considered as a drastic last resort. Your involvement must be limited to that degree justified by necessity. Unlike combat operations where the use of overwhelming fire-power is desirable, civil disturbance control operations must be accomplished with minimum injury to persons or damage to property. The use of force must be restricted to the minimum degree consistent with mission

accomplishment. The use of excessive or unnecessary force may subject the responsible person to civil and/or criminal liability and may serve to increase public sympathy for the demonstrators.

APPLICATION OF FORCE

LEARNING OBJECTIVES: State the paramount principle when using force during a civil disturbance. List three items that should be included when control force personnel are briefed Explain when nondeadly and deadly force may be used, and when deadly force is authorized. State eight policies regarding the use of deadly force.

The guidelines of the application of force, which follow, are designed specifically for operations during civil disturbances.

PARAMOUNT PRINCIPLE

Control force personnel must at all times use only the minimum force required to accomplish the mission. This principle should control both the selection of appropriate operational techniques and tactics and the choice of options for arming control force personnel. Therefore, the use of deadly force or any other type of physical force likely to cause death or serious bodily harm is authorized only under extreme circumstances where certain specific criteria are met. Currently, shotguns are the basic weapon for control force members in a civil disturbance area, but supervisors must ensure that only the weapons specified by the commanding officer are used.

BRIEFING OF PERSONNEL

All personnel, prior to participation in civil disturbance operations, should be briefed as to

- the specific mission of the unit;
- the rules governing the application of force as they apply to the specific situation; and
- the local situation, specifically addressing types of abuse that military personnel may be expected to receive and the proper response to these types of abuses.

USE OF NONDEADLY AND DEADLY FORCE

Control force squad leaders are authorized to use nondeadly force to control a disturbance, to prevent crimes, and to apprehend or detain persons who have committed crimes. The degree of force used must be no greater than that reasonably necessary under the circumstances. The use of deadly force, however, in effect involves the power of summary execution and can therefore be justified only by extreme necessity. Accordingly, its use is not authorized for the purpose of preventing activities that do not pose a significant risk of death or serious bodily harm, such as curfew violations or looting. If a mission cannot be accomplished without the use of deadly force and deadly force is not permitted, accomplishment of the mission must be delayed until sufficient nondeadly force can be brought to bear.

AUTHORIZATION FOR DEADLY FORCE

The use of deadly force is authorized only when all three of the following circumstances are present:

1. Lesser means have been exhausted or are unavailable.
2. The use of deadly force will not significantly increase the risk of death or serious bodily harm to innocent persons.
3. Deadly force is justified under one or more of the following circumstances:
 - a. Self-defense and defense of others. When deadly force reasonably appears to be necessary to protect law enforcement or security personnel who reasonably believe themselves or others to be in imminent danger of death or serious bodily harm.
 - b. Assets involving national security. When deadly force reasonably appears necessary to prevent the actual theft or sabotage of assets vital to national security. DOD assets should be specifically designated as vital to national security only when their loss, damage or compromise would seriously jeopardize the national defense mission. Examples include nuclear weapons; nuclear command, control, and communications facilities; and designated restricted areas containing strategic operational assets, sensitive codes, or special access programs.

- c. Assets not involving national security but inherently dangerous to others. When deadly force reasonably appears to be necessary to prevent the actual theft or sabotage of resources, such as operable weapons or ammunition that when in the hands of an unauthorized individual, present a substantial potential danger of death or serious bodily harm. Examples include high-risk portable and lethal missiles, rockets, arms, ammunition, explosives, chemical agents, and special nuclear material.
- d. Serious offenses against persons. When deadly force reasonably appears necessary to prevent the commission of a serious offense involving violence and threatening death or serious bodily harm. Examples are murder, armed robbery, and aggravated assault.
- e. Arrest or apprehension.—When deadly force reasonably appears to be necessary to arrest, apprehend, or prevent the escape of a person who has committed an offense of the nature specified in paragraph b, c, and d above.
- f. Escapes. - When deadly force has been specifically authorized by the Heads of the DOD components and reasonably appears to be necessary to prevent the escape of a prisoner, provided law enforcement or security personnel have probable cause to believe that the escaping prisoner poses a threat of serious bodily harm either to security personnel or others.

THE RIGHT OF SELF DEFENSE

Each person, under the law, has the right to use force that may be reasonably necessary to defend one's self against violent and dangerous personal attack. The limitations described in the previous paragraphs are not intended to infringe this right. However, a control force member is subject to a chain of command. And as such, the member must act in accord with orders issued and as a member of a unit. Therefore, unless the attack is directed at the member personally and is a threat to life, the control force member's response must be governed by the immediate supervisor.

VITAL FACILITIES

In each situation where Federal forces are committed, the installation commanding officers must determine which facilities within the area of operation constitute "vital facilities." Parameters must be established that justify the use of deadly force in order to be protected. MAs assigned to security missions must know if a particular facility or activity is so vital to the health and safety of the public that the use of deadly force would be justified in the protection of the facility or activity.

POLICIES REGARDING THE USE OF DEADLY FORCE

In addition, the following policies regarding the use of deadly force should be observed:

- Installation commanding officers may, at their discretion, delegate the authority to authorize the use of deadly force provided that the person to whom such delegation is made understands the constraints upon the use of deadly force.
- Even when its use is authorized, deadly force must be employed only with great selectivity and precision against the particular threat that justifies its use. For example, the receipt of sniper fire, however deadly, from an unknown location can never justify returning the fire against any or all persons who may be visible on the street or in nearby buildings. Such an indiscriminate response is far too likely to result in casualties among innocent bystanders or fellow control force personnel. The appropriate response is to take cover and attempt to locate the source of the fire, so that the threat can be neutralized.
- When possible, the use of deadly force should be preceded by a clear warning to the individual or group that the use of such force is contemplated or imminent.
- Warning shots are not to be employed. Such firing constitutes a hazard to innocent persons and can create the mistaken impression on the part of citizens or fellow control force personnel that sniping is widespread.
- Control force personnel should never carry unloaded firearms. But remember, command control arrangements should be specifically designed to facilitate careful control of deadly weapons. Control force leaders must be clearly

instructed about their personal obligation to withhold permission for use of deadly force until circumstances indicate a high probability that deadly force will be imminently necessary.

- Control force members will, at all times, exercise positive control over the use of weapons. Individual MAs will be instructed not to fire a weapon except when authorized by a control team leader. However, if you are not under the direct control of a team leader, use deadly force only when justified.
- When a weapon is fired it will be fired with the intent to render the person incapable of continuing the activity that caused the control force member to shoot.
- The safety of innocent bystanders should always be taken into account before shots are fired.

OPERATIONAL TASKS AND TECHNIQUES

LEARNING OBJECTIVES: State the purpose of an operational task evaluation. Explain the importance of carefully choosing a force option. State the reason for isolation of an area and for securing likely targets.

In any civil disturbance control operation, certain tasks must be accomplished to reach the ultimate objective of restoring and maintaining law and order. To do this, action must be taken to gain control of the situation. Control forces must perform certain tasks to develop a physical and psychological environment.

OPERATIONAL TASK EVALUATION

It is equally important that the operational tasks be selected only after a careful evaluation of the situation. This evaluation must consider the uniqueness of the situation. In this respect, the installation commanding officer selects those tasks that are most likely to reduce the intensity of the confrontation by effectively managing the given situation. Therefore, not all tasks will apply in all situations. Installation commanding officers and control team leaders identify those tasks that must be performed and then develop plans and procedures for their accomplishment. The importance of having a high degree of flexibility and selectivity in the response cannot be overemphasized.

OPTIONS WHEN USING FORCE

The commitment of Federal military forces must be viewed as a drastic measure. Their role, therefore, should never be greater than is absolutely necessary under the prevailing circumstances. This does not mean, however, that the size of the control force employed should be minimized. On the contrary, the degree of force required to control a disturbance is frequently opposite to the proportional number of available personnel. The presence of large numbers may prevent the development of situations in which the use of deadly force is necessary. A large reserve of personnel should be maintained during this type of operation. The knowledge that a large reserve force is available builds morale among military and law enforcement personnel and contributes toward preventing overreaction to provocative acts by disorderly persons.

In selecting an operational approach to a civil disturbance situation, the commanding officer and staff must observe the "minimum force" principle. For example, crowd control formations or riot control agents should not be used if saturation of the area with manpower would suffice.

Avoid appearing as an alien, invading force. Present the image of a restrained and well-disciplined force whose sole purpose is to assist in restoration of law and order with a minimum loss of life and property. Show respect to those citizens whose involvement may be purely accidental. Further, while control force personnel should be visible, tactics or force concentrations that might tend to excite rather than to calm should be avoided where possible.

ISOLATE THE AREA

Isolating the area encompasses the restriction and sealing off of the disturbed area. The objectives of isolation are to prevent the disorder from spreading to unaffected areas, to prevent the escape of individuals determined to expand the disturbance, to expedite the departure of the uninvolved, and to exclude unauthorized personnel from entering the affected area. Therefore, to stop the disorder from expanding in size and intensity, it is critical that no additional demonstrators or curious onlookers be allowed into the disturbed area.

The initial commitment of control force personnel may be required to clear a building or an area to isolate the individuals creating the disturbance from those not yet motivated or actively involved. The primary

emphasis should be on identifying the area to be cleared and who has to be isolated.

SECURE LIKELY TARGETS

Certain buildings, utilities, and services are critical to the economic and physical well-being of a community and require security to prevent disruption of essential functions. In addition, certain facilities and buildings have become symbolic targets to radical or extremist elements and must be identified and afforded protection within the priorities established.

The techniques for securing likely targets consist essentially of providing physical security. Military forces are ideally organized and equipped to perform this task. Security of Government buildings and public utility facilities is a normal mission for military forces in most types of civil disturbances. This releases civil police to operate within the disturbed area in their law enforcement capacity.

CONTROL OF CROWDS OR MOBS

LEARNING OBJECTIVES: Identify seven variables of crowds or mobs. Describe four crowd control options. Explain the difference between crowds and mobs and describe four ways in which a crowd becomes a mob.

Civil disturbance operations, especially those conducted over extended periods, require control forces to confront a variety of crowds and mobs. Crowds and mobs differ in many ways, and these differences are called variables.

VARIABLES OF CROWDS OR MOBS

Consideration of the following variables will indicate the general nature of the mob or crowd, and the most appropriate reamer of controlling them:

- The current intensity level of the civil disturbance
- Public opinion
- Current policies
- Crowd and mob mood, intent, composition, and activity
- Capabilities and readiness of control forces

- Immediate and long range benefits of control force action
- Weather, terrain, and time of day

CROWD CONTROL OPTIONS

In general terms, four crowd-control options are available. They are monitoring, dispersing, containing, and blocking. A prime consideration in selecting an option will be the capability of control forces to accomplish the desired option.

Monitoring

Monitoring consists of watching the crowd's progress and development by control force teams. Monitoring enables the commander to evaluate the crowd's activity and intent in relation to the larger civil disturbance and possibly to influence the crowd through passive means. This option is appropriate for large, nonviolent demonstrations where more decisive action is not feasible, because of crowd size, and acts as an interim measure pending the arrival of additional control forces. Techniques for accomplishing this option include passive observation of the crowd, and the communication of interest and intent to leaders.

Dispersing

Dispersing is an action taken to fragment a crowd. It is especially applicable to large crowd situations in a congested urban environment. Its selection should include the consideration that dispersion may increase and spread lawlessness rather than reduce it. Techniques for accomplishing this option would include the show of force, use of riot control formations, and use of riot control agents.

Containing

Containing means restraint of a large number of individuals within the area they are presently occupying, thereby stopping any further aggressive activity. This option would be appropriate in a college campus situation to prevent rioters from spreading to surrounding communities and to prevent unauthorized personnel from entering the campus. Containing would also be appropriate where the systematic arrest of crowd members is contemplated. Riot control formations and use of barricades comprise the primary techniques for this option.

Blocking

Blocking consists of actually stopping a crowd's advance toward the potential or actual target. Riot control formations and barricades are the most appropriate tools.

DISTINCTION BETWEEN CROWDS AND MOBS

A crowd is a group or a number of separate groups that may be orderly or disorderly but that has not lost its collective sense of fear. A mob, on the other hand, is distinguished by the fact that, under the stimulus of intense excitement, its members have actually lost the sense of fear of the law.

Mobs develop from crowds, but in most cases mobs could be prevented by the proper application of crowd tactics. A crowd lacks organization and unit of purpose; but if bent on mischief, a crowd requires only a leader to become a mob. If the crowd is compelled to move on and break up, however, there is usually little danger.

A crowd assembled for an unlawful purpose hesitates to commit itself to a course of unrestrained violence. But some of its members may perform violent acts when they think they have little chance of being apprehended and punished.

CONVERSION FROM CROWD TO MOB

The crowd, although noisy and threatening, should be kept well in hand. If left to its own devices, the crowd is likely to commit assaults and other actions that may excite it to a mob pitch. A crowd might be converted into a mob by the following:

- Apparent weakening of the forces holding a crowd in check, even though only a momentary weakening
- A single piece of daring violence successfully carried through
- A short lecture by a fiery leader
- The appearance on the street of a conspicuous and hated figure

Civil and military officials must ensure that this transformation does not take place. The formation of a mob usually means bloodshed before order is restored.

CROWD CONTROL TECHNIQUES

LEARNING OBJECTIVE: Explain and discuss the various techniques for crowd control.

There are numerous techniques designed to provide the commander with flexibility of action in accomplishing crowd control. The commander must select a combination of techniques that will produce the desired results within the framework of the selected crowd control option. The most common techniques are discussed in the following paragraphs.

OBSERVATION

Observation consists of the deployment of individuals or teams to the outermost region of a crowd for the purpose of monitoring the crowd's activity. It includes gathering information on crowd size, location, and mood, and reporting on the developing situation.

COMMUNICATION OF INTEREST AND INTENT

In certain situations, effective communication with crowd leaders and participants may enable the force to control the situation without resorting to more severe actions. When planned and organized demonstrations, marches, or rallies within the disturbed area are announced, the control force commander, in coordination with local authorities, should meet with the activity organizers to communicate the interest of the control forces.

The installation commanding officer and local authorities should communicate to the activity organizers their intent to cope with violence, unlawful actions, and violations of restrictions imposed on the activity. It is intended that, by this communication between activity organizers and control force personnel, the demonstration, rally, or parade will occur without incident through the mutual cooperation of all concerned. The intentions of control forces will not be effective if delivered as an ultimatum. A limited, begrudging dialogue with activity organizers reduces the opportunity for authorities to learn the plans of the demonstrators. It must be remembered that if this communication is not effective, the activity organizers might well hold the demonstration in defiance of local authorities.

CHANNELIZATION

Where communications have been established with the dissident leadership and the intent and nature of the crowd activity is known in advance, pressure may be brought to bear on the leaders. This will channel the crowd into an area that will minimize the disruption that the crowd might have on the community, and that will facilitate the operations of the control force.

DIVERSION

Consideration may be given to efforts to divert the leadership of the crowd itself from its stated or apparent objective. This effort is greatly facilitated if communications exist with the leadership of the crowd. This technique may be either direct, denying access to an area, or indirect, promoting an alternate site or activity of greater interest to the crowd. The diversion should support the objectives of the control force either by reducing the intensity of the crowd situation or by motivating the crowd to seek an area more easily controlled by the control force.

COOPERATION

The control force must seek to obtain the cooperation of the dissident leadership, which will decrease the potential for disruption. Also, when crowd leadership seeks permission and cooperation from the local government, officials should maximize this opportunity. This may be accomplished by talking the leadership into a cooperative planning effort designed to facilitate the protestor's opportunity to peacefully demonstrate. This will also establish guidelines that will minimize the impact of the demonstration on the community.

PROCLAMATION

The installation commanding officer's representative at the scene, in the Name of the President of the United States, will call upon members of the group to disperse to their homes immediately. This is known as the Presidential proclamation. Another proclamation will be issued by the military commander to advise the people residing within the community of the rules and orders they are to obey and the reasons for such rules. This proclamation by the military is not to be confused with the Presidential proclamation. A proclamation establishes the illegal nature of the crowd's actions, and is an excellent medium to make known to a crowd the intentions of the control force.

SHOW OF FORCE

A show of force may be effective in various situations in civil disturbance control operations. Marching a well-equipped and highly disciplined control force into view of an assembled crowd maybe all that is needed to persuade dissidents to disperse and retire peaceably from the scene. In other situations, however, a show of force may have a counterproductive effect. It may cause more persons to be attracted to the "show" and provoke a nonviolent crowd into a violent confrontation. When personnel are scattered throughout the disturbance area in small groups, a show of force may take the form of motor marches throughout the area saturation patrolling, and the manning of static posts.

APPREHENSION OF CROWD MEMBERS

The apprehension of an individual can only be justified if that person is in violation of the law. Situations may arise in a crowd control mission where large numbers of persons are participating in unlawful activities. The dispersal of such groups might result in greater violence or militant acts. Factors may exist that preclude the use of water or riot control agents, thus necessitating the containment of the crowd in a given area or the apprehension and removal of those crowd members committing unlawful acts. Where possible, military forces should allow civil police officers to perform the actual apprehension, processing, and detention of civilian law violators. However, conditions of necessity may require these functions to be performed by military personnel.

USE OF BARRIERS

On a pier or wharf, barriers can be effectively used to channel intruders and prevent vehicles from being driven near the ship.

For a ship, lining off or lifting the brow will help in reducing access to the ship. Additionally, extra camels can be requested to increase the distance between the ship (especially those with a low freeboard) and the shore structure.

Secure and lock as many weather deck accesses as possible to limit entry by boarders and as a prevention measure from weapons fire and thrown incendiary devices.

EMPLOYMENT OF WATER

Water from a firehose may be effective in moving small groups on a narrow front, such as a street or in defending a barricade or roadblock Personnel applying water should be protected by the control force, and in some instances, by shields.

A water-dispersing system specifically designed for use in civil disturbance operations is not included in the Navy supply inventory, but may be improvised from existing items of equipment. Water may be employed in a flat trajectory (solid-stream) or as a high trajectory weapon (employing water as rainfall). The latter is highly effective during cold weather.

The use of a large water tank (750-1,000 gallons) and a mounted "water cannon" will enable the force to employ water as they advance. By having at least two such trucks, one can be held in reserve.

Aboard ship, water hoses can be laid out in advance. The fire stations to be used will usually be indicated by their location, including the availability of cover for hose teams. Past actual experience has shown that foam (AFFF) has had a disorienting effect on crowds, and has increased the effectiveness of firefighting from the ship when objects on or to the pier, including vehicles and mooring lines, were set afire by the crowds.

In the use of water, as with other measures of force, certain restraints must be applied. Avoid using water on innocent bystanders. Provide avenues of escape and use the more severe, flat trajectory application only when necessary.

RIOT CONTROL AGENTS

The use of riot control agents is an effective method of dispersing crowds. Remember, however, that effects of riot control agents are only temporary and will not prevent the reformation of a crowd in either the same or a different location. Riot control agents have many advantages over other techniques in that they have an immediate effect on large groups of people without causing any permanent harm. Riot control agents, when properly used by the control force, will disperse large crowds without actual contact with rioters. An understanding of riot control agents, their capabilities and limitations, is mandatory for safe and efficient use. The authority to order the use of riot control agents rests with the installation commander.

PHOTOGRAPHY

Filming or photographing persons engaged in lawful dissent (picketing, peaceful protest, etc.) is not warranted and should be avoided. However, filming persons engaged in unlawful conduct is recommended as a future record for court proceedings to show that crimes were being committed and/or the identity of the persons committing those crimes. Additionally, filming of events can quickly resolve complaints of excessive force by force personnel.

MILITARY WORKING DOGS

The proper use of military working dogs as part of the control forces can be a great deterrent. In especially unruly crowds, extra care must be given to protection of the dogs from the crowd itself, thrown objects, and crowd control agents.

MOB CONTROL TECHNIQUES

LEARNING OBJECTIVES: Explain and discuss the various techniques for mob control.

The methods employed against mobs differ from those required against crowds. Less dispersion of forces is allowed; more force must be used (but kept well under control); and sterner measures must be adopted. The following mob control techniques are recommended:

- Messages to the mob. A mob should not be lectured, bullied, or bluffed. And above all, it should not be threatened or dared.
- Direction of attack. A mob usually should be attacked on one flank, depending upon the direction the mob should be moved. When those in front would like to retreat but because of the pressure from behind are unable to do so, the mob should be attacked from the rear.
- Use of gunfire. The number of firearms used should be no greater than is absolutely necessary. If there is firing from the rear of the mob, a few marksmen should be placed where they can return the fire at that source only. A few marksmen should also be detailed to return fire on windows or roofs from which firing or sniping is occurring. Care should always be taken to avoid firing into a group of innocent persons from which some rioter has fired.
- Blank cartridges. Blank cartridges should never be used when combating a mob bent on violence,

nor should a volley be fired over their heads. Such action may be regarded as an admission of weakness or as an attempt to bluff, and may do much more harm than good.

- Use of tear gas. Tear gas grenades, employed by military forces equipped with gas masks, are an effective method of dispersing a mob. Tear gas grenades should be projected to the windward side of the rioters.
- Hand-to-hand fighting. Hand-to-hand fighting should be avoided. Here, the mob has the advantage because of its superior number. The mob should be kept at such distance that personnel can employ their weapons and use their training and discipline to the best advantage.
- When things are thrown. When confronted by a control force, an angry mob often begins to look for things to throw at the control force. When control force personnel are jumping, running, and dodging flying objects, the appearance of disorganization exists, and a lack of discipline could possibly encourage the mob to be more aggressive. When a mob is throwing objects, the control force should be equipped with riot shields to enable them to hold their ground in a professional manner.
- Use of riot shields. Military and Federal law enforcement personnel on duty at the various Cuban Refugee Camps in 1980 suffered many casualties. Most of the injuries were caused by thrown objects. It was discovered that helmets and face shields and flak jackets alone do not offer sufficient protection. Casualties were reduced and better control was realized when riot shields were introduced and properly used by the various agencies. Riot shields not only provide protection for the officers, but are tools for pushing back crowds.

CROWD AND MOB CONTROL FORMATIONS

LEARNING OBJECTIVES: Describe the three types of formations used in crowd and mob control. Explain why formation interval is important.

Crowd control formations can be used effectively in many disturbance situations. When properly

employed and effectively executed, they represent one of the more practical methods of controlling and dispensing the massed crowd. Crowd control formations are particularly effective against large crowds because they provide to the control force the capability of splitting the crowd or mob into manageable segments.

The limitations of formations must be realized. Formations are not the answer to all disturbance situations. Crowd control forces should not be subjected to unnecessary sniper fire and violent tactics of agitators simply to impress the people with a show of force. When small, dispersed mobs are rampant in an area of operations, formations will be of little value. Further, when a large mob has been split up, the problem is not

necessarily solved. Do not assume that rioters have given in and returned to peaceful activities. The small elements may break away from the large mob and engage in small dispersed mob tactics such as sniping, looting, and burning.

TYPES OF FORMATIONS

Lessons learned from civil disturbances in the United States indicate that the most frequently used formations are the wedge, the line, and the echelon. See figure 9-1. A rioting mob usually is attacked on the flank. In general, rioters should be driven to an area where they can do the least damage. Force **MUST** be kept to a minimum, as violence by the military may cause a mob to become more ferocious.

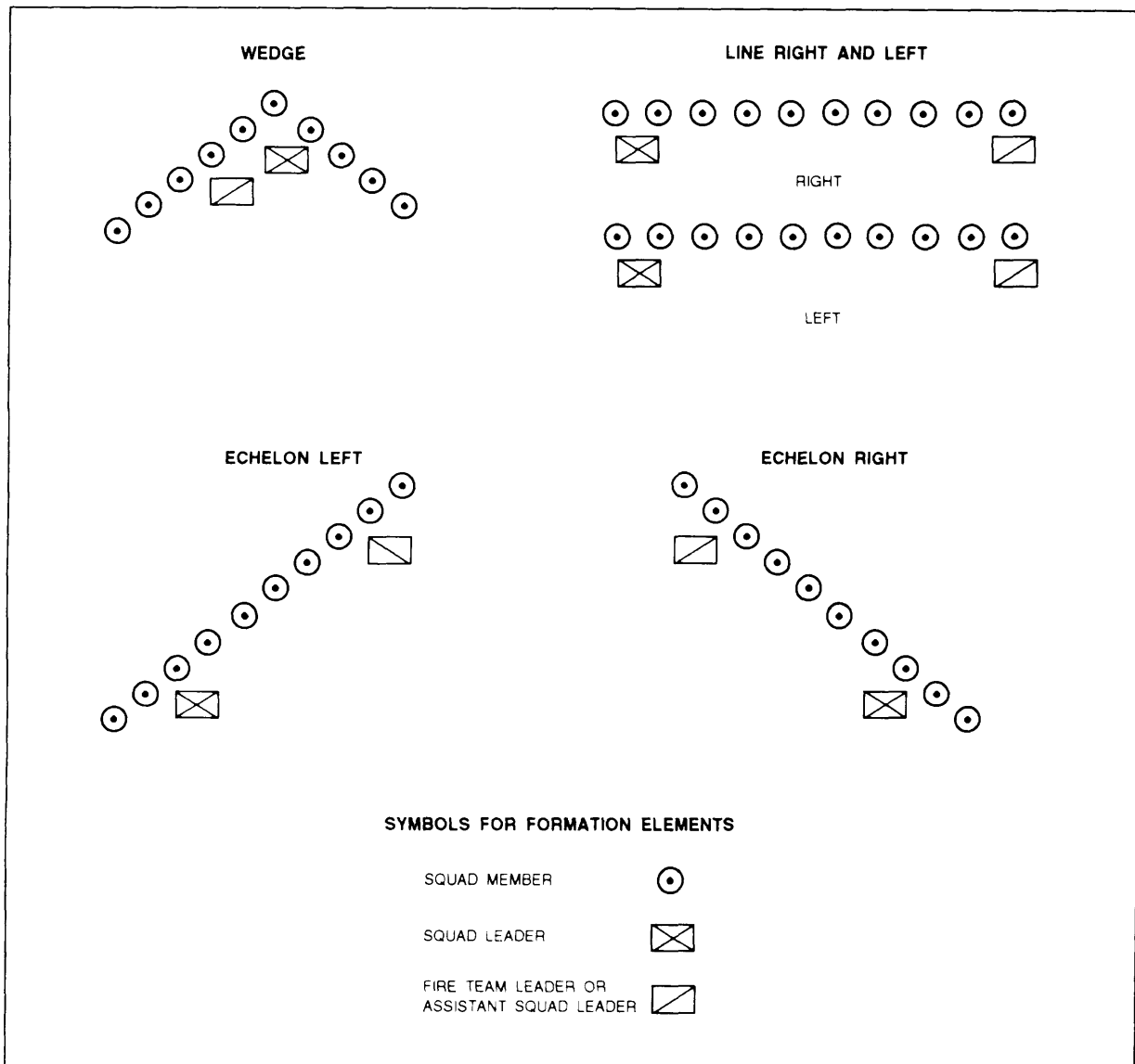

Figure 9-1. The wedge, line, and echelon formations.

Wedge

As an offensive formation, the wedge is used to penetrate and split crowds. A wedge of about 35 persons is suitable for clearing an ordinary city street. Normally, about 18 persons should be deployed in the wedge itself, with 3 people supporting each flank. The remaining people form columns of two's in the center of each wedge as support. The flanks of the wedges may be reinforced as necessary.

Line (right or left)

The line formation is most often used because of its offensive and defensive purposes. The position of the squad leader in the line determines right or left line formation. As an offensive formation, the line is used to push or drive crowds straight back or across an open area or up a city street. As a defensive formation, the line might be used to hold a riotous group or to deny access to restricted streets or areas.

Echelon (right or left)

The echelon is an offensive formation used to redirect groups in either open or built-up areas, and to move crowds away from buildings, fences, or walls. The squad leader is positioned at the rear of the echelon, and the direction of crowd movement from the squad leader's point of view determines right or left echelon.

FORMATION INTERVAL

Experience has shown that formations, to be effective, must be tailored to meet the situation. The members of a formation are usually separated by a one pace (30-inch) interval, but this spacing might not be sufficient in some situations and may need to be expanded or reduced. Some police forces have discovered that a greater interval makes members less susceptible to injury from thrown objects and a tighter interval reduces infiltration possibilities. The control force commander should adjust the formations to fit the needs of the particular situation.

Figure 9-2 illustrates various ways that crowds and mobs can be dispersed in different situations. For example, in part A of figure 9-2, the attacking force is using an echelon right formation to move a crowd away from a public building. In parts B, C, D, and E of figure 9-2, other formations in various configurations are shown.

Complete information and instruction of the use of formations, oral and visual commands, and organization of crowd control formations is contained in the U.S. Army Field Manual 19-15, *Civil Disturbances*.

FORMATION WEAPONS AND CARRY POSITIONS

LEARNING OBJECTIVES: Identify and describe the weapons used in control formations. Explain how to properly use riot control agents. Demonstrate three carry positions for weapons in control formations.

Weapons used in formations include the riot baton and the riot shotgun. Other weapons that may be used in a sophisticated situation are sniper rifles, hand guns, and riot control agent dispersers. In this section, we will also look at how the weapons should be held while in formation. But first, let's look at the weapons themselves.

THE RIOT BATON

The riot (36-inch) baton is most effective in a crowd control operation and is the primary weapon for such operations. The baton is an offensive weapon with reduced lethality and, unlike the shotgun, the loss of a baton to the crowd does not create a serious threat. The riot baton may also be used in combination with the shotgun by having the control element confronting the crowd armed with riot batons and the support element armed with shotguns. If the riot baton is not available, nightsticks or patrol batons (22- to 26-inch) may be substituted, but with reduced effectiveness.

THE RIOT SHOTGUN

The riot shotgun is an extremely versatile weapon and is the primary individual weapon. The shotgun's appearance and capability produce a strong psychological effect on rioters, and it is particularly suited to certain applications in civil disturbance operations. When used with No. 00 buckshot, it is effective at limited range; however, use of No. 00 buckshot should be limited to specific missions.

RIOT CONTROL AGENTS

Riot control agents have a high safety factor and will not seriously endanger health or cause death when

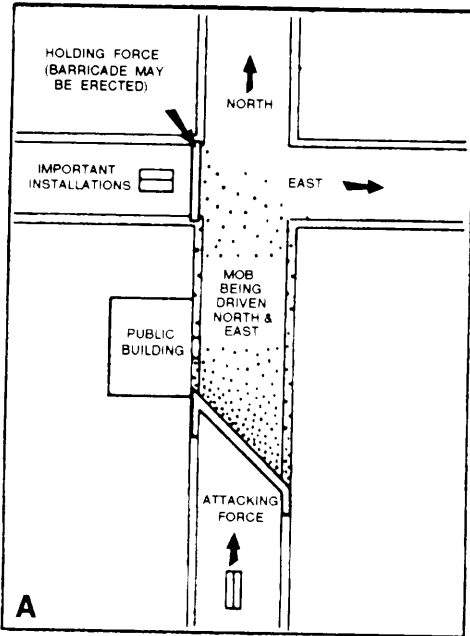

A METHOD OF DRIVING A MOB FROM THE FRONT OF A BUILDING

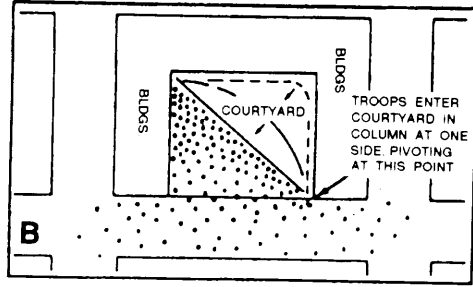

A METHOD OF DRIVING A MOB FROM A COURTYARD HAVING SOLID WALLS

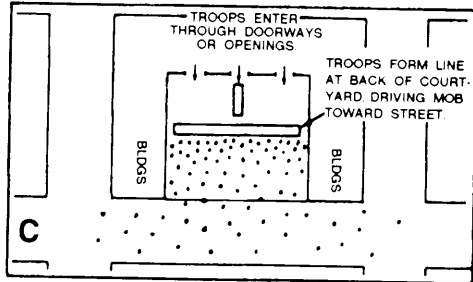

A METHOD OF DRIVING A MOB FROM A COURTYARD HAVING DOORWAYS AND OTHER OPENINGS IN THE WALLS

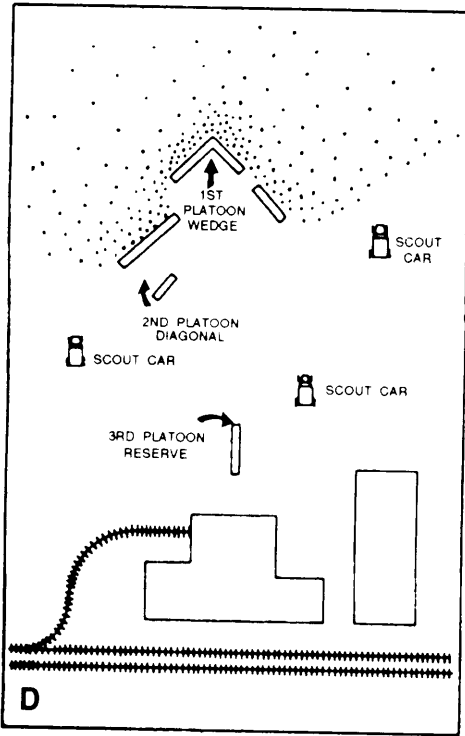

A METHOD BY WHICH A COMPANY DISPERSES A MOB AND DRIVES IT AWAY FROM AN IMPORTANT INSTALLATION IN OPEN TERRAIN

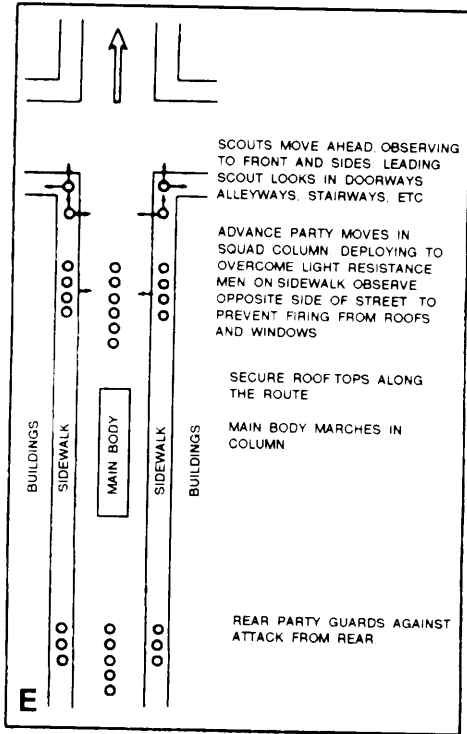

A COLUMN MARCHING THROUGH CITY STREETS PROTECTS ITSELF BY ADVANCE AND REAR GUARD

Figure 9-2.-Mob dispersal techniques

used properly. Riot control agents should not be used in hospital areas or other areas when undesirable effects may result from their use. Only designated and trained personnel should use riot control agent dispersers.

POSITIONS FOR WEAPONS

The civil disturbance control force should hold their weapons as prescribed by the commander. The methods include safe port position, safe guard position, and on guard position.

Safe Port

The “safe port” position is shown in figure 9-3. This position is extremely useful in making a show of force. In this elevated position, weapons can be seen by the

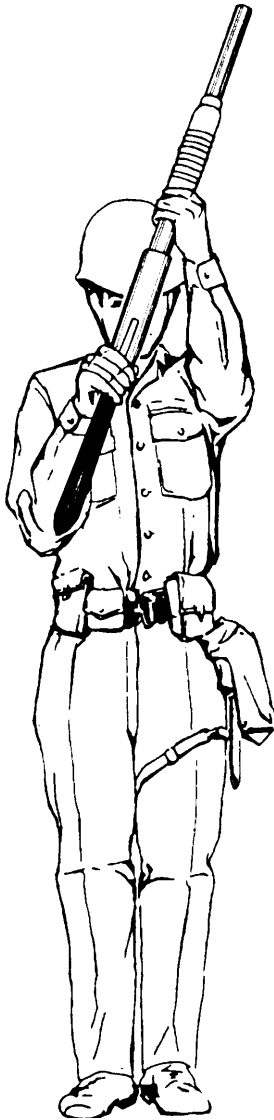

Figure 9-3.-Safe port position.

participants in the middle or rear of a group. The sight of these weapons can create an impression of strength and superiority. However, control force members should not be required to maintain the position for extended periods of time, as it is very tiring.

Safe Guard

The “safe guard” position (fig. 9-4) is one of semi-readiness. It is less tiring than the “on guard” position and should be used to rest the control force when circumstances permit. For example, as the control force advances, they should maintain the “safe guard” position until just before contact is made or resistance is expected and then be ordered to the “on guard” position. The “safe guard” position can also be used when pursuing a crowd withdrawing without resistance.



Figure 9-4.-Safe guard position.

On Guard

The "on guard" position (fig. 9-5) is one of complete readiness and should be used whenever the control force is in contact with a group that is showing resistance or a hesitance to withdraw. It is a tiring position to maintain for extended periods of time. The force should be rested at every opportunity by using less tiring positions.

MENTAL PREPARATION FOR CIVIL DISTURBANCE OPERATIONS

LEARNING OBJECTIVES: Explain the importance of mental preparation for civil disturbance operations. Describe how control force members should react to stress. Explain how psychological influences impact on control force members themselves.

A special need exists to prepare individuals for the mental and physical stress of civil disturbance control operations. Training in this subject area should be



Figure 9-5.-On guard position.

oriented both toward understanding crowd and mob behavior and toward preparing units to control their own actions and emotions. Typical causes of civil disorders should be studied to give individuals a better understanding of why they maybe called upon to control civil disorders. Group behavior should be sufficiently discussed to show individuals what to expect. Further, personnel must be made aware of the influence of psychological factors upon their own behavior.

INDIVIDUAL RESPONSE TO STRESS

Masters-at-Arms engaged in civil disturbance operations will be subjected to noise and confusion created by large numbers of people facing them. Individual MAs may be shouted at, insulted, and called abusive names. You must learn to ignore these taunts and not allow personal feelings to interfere with the execution of your mission. In addition, you can expect objects to be thrown at you; however, objects must never be thrown back. You must subdue your emotions and carry out orders with determination and with "controlled aggression" whether in formation, patrolling, or posted as sentries.

MAs must be emotionally prepared for unusual actions, such as members of the crowd screaming and rushing toward them, or persons tearing off their own clothes or deliberately injuring or maiming themselves. You should understand that the well-disciplined execution of orders is the most effective force applied against rioters. Personnel must be indoctrinated in all aspects of self-control so that they are mentally prepared for participation in civil disturbance operations.

An effective way to familiarize MAs with the stress of confronting a mob is to conduct an exercise employing part of the unit as violent demonstrators, with the remainder acting as the control force. Have the "mob" harass those acting as the control force in a manner as realistic as possible, consistent with safety.

PSYCHOLOGICAL INFLUENCES

Just as the crowd may be swept into violence by the psychological influences of anonymity, impersonality, suggestion and imitation, emotional contagion, and release from repressed emotions, the control forces reaction may be inappropriate because of the effect of such factors on them. Both the leader and the control force members must be made aware of these factors so that they can cope with them in the civil disturbance environment.

The cumulative effect of these psychological factors may be an excessive response by control force personnel, who are often thrust into situations with little time to brief them about the situation. They may be confronted by individuals who express personal hostility in a manner that they are not prepared to handle unless they have been properly conditioned. It is extremely important that control force personnel be fully oriented, conditioned, and sensitized so that they can better cope with these problems in a civil disorder environment.

The fatigue factor must also be taken into consideration in determining the ability of control force personnel to deal with provocation and temptation, abusive language, taunts, invitations to seduction, offers of food and drink, physical missiles, tracts, and leaflets. Studies of recent disorders reveal that control forces tend to suffer strain, anxiety, and fatigue when they are kept on duty for extended periods of time. Rumors of violent acts committed against fellow members of the force also increase tension. After a while, they may begin to believe that they are in a war, and that all dissidents are their enemies. Sniping incidents tend to confirm their suspicions and provide assumed justification for revenge by excessive use of force or retaliation with massive firepower.

In situations where the control forces become emotionally involved, the force commander may lose control over the actions of their personnel. The control forces must be made fully aware of the reasons for which

they have been committed. If they are not fully aware and prepared for the situation, they may act improperly or fail to act on command. Official reports stress the importance of training to develop self-discipline and teamwork.

SUMMARY

In this chapter, we pointed out the agency responsible for civil disturbances and described categories of intervention. Collective behavior factors and how they impact on various groups was also considered. Next, we looked at the psychological influences on crowds, the factors that affect crowd behavior, and how crowds are affected by panic. Then we looked at some incidents that might occur in a mob action and those incidents that a mob might take against a control force. Management of civil disturbances and principles of control were also considered. The application of force was examined, and the principles relating to nondeadly and deadly force were outlined. Operational techniques for choosing force options along with various crowd control options were discussed. Next, we considered the various techniques for crowd and mob control. Three types of formations used in crowd control were described, followed by a discussion of formation weapons and carry positions. Finally, mental preparation for civil disturbance operations, individual response to stress, and the psychological influences on a control force were covered.

CHAPTER 10

PHYSICAL SECURITY

Physical security is that part of security concerned with physical measures designed to safeguard personnel; to prevent unauthorized access to equipment, facilities, material, computer media, and documents; and to safeguard them against espionage, sabotage, damage, and theft. This chapter addresses the many facets of a physical security program.

PHYSICAL SECURITY DEFINITIONS

LEARNING OBJECTIVE Define 12 terms that apply to physical security programs.

The following definitions apply to the physical security programs as discussed in this chapter:

- *Activity*. Any unit of the Naval Shore Establishment of distinct identity and established under an officer in command or in charge, by direction from appropriate authority.
- *Auxiliary Security Force (ASF)*. An armed force composed of local, nondeploying military assets derived from host and tenant commands under the operational control of the host command's security department. The ASF is used to augment the installation's permanent security force during increased threat conditions or when directed by the host command.
- *Counterterrorism*. Offensive measures taken to prevent, deter, and respond to terrorism.
- *Exception*. A written, approved, long-term (36 months or longer) or permanent deviation from a specific security requirement.
- *Facility*. A real property entity consisting of one or more of the following: a building, a structure, a utility system, pavement, and underlying land.
- *Installation*. A grouping of facilities, located in the same vicinity, that support particular functions. Installations may be elements of a base.
- *Pilferage*. Petty larceny; stealing of small items, generally stored goods.
- *Property*. All assets, including real property, facilities, funds, and negotiable instruments; arms,

ammunitions, and explosives; tools and equipment; material and supplies; microwave towers; communication antennas and power transformers; computer hardware and software; and information in the form of documents and other media, whether categorized as routine or special, unclassified or classified, nonsensitive or sensitive, conventional or nuclear, critical, valuable or precious.

- *Plan of action and milestones (POA&M)*. A written document identifying specific security deficiencies, corrective courses of action, and expected dates of completion.

- *Security manager*. An individual, appointed in writing by the commanding officer, responsible for the development, implementation, and management of the command's Information and Personnel Security Program. The security manager acts as the commanding officer's principal advisor in matters pertaining to the security of classified information.

- *Security officer*. An individual appointed in writing by the commanding officer, who is responsible for the development, implementation, and management of the command's Law Enforcement and Physical Security Program.

- *Waiver*. A written temporary relief, normally for a period of 1 year, from specific security requirements, pending actions or accomplishment of action that will result in conformance with the minimum security standards.

SECURITY RESPONSIBILITIES

LEARNING OBJECTIVES: Explain individual responsibility for security in the Navy. List the specific responsibilities of the commanding officer, security officer, and security manager. Describe the composition of a security department, and list the five basic categories of duties of a security department. Explain the organizational role of the security officer in a command's security program.

Security is the direct responsibility of every person (military and civilian) in the Department of the Navy.

To have a good physical security program, the program must receive command attention and direction from all echelons within the chain of command. The physical security functions should be carried out by well-trained personnel. Much emphasis is placed on the commanding officer to make sure the commands security posture is accurately assessed and that security resources are appropriate to execute these programs.

COMMANDING OFFICER

The commanding officer of an activity is ultimately responsible for all security, including physical security, within that activity. The commanding officer makes the appointment of an adequately trained and/or experienced security officer to develop and manage the physical security program, which is paramount to the command's mission. The commanding officer also provides sufficient resources, staff assistance, and authority to the security officer to implement, manage, and execute an effective Physical Security and Loss Prevention Program.

SECURITY OFFICER

The security officer is designated in writing by the commanding officer. The security officer reports directly to the commanding officer, keeping the executive officer informed, and is responsible in assisting the commanding officer by determining the adequacy of the command's Physical Security and Loss Prevention Program. The security officer identifies those areas where improved physical security and loss prevention are required. Chapter 1 of the *Physical Security and Loss Prevention Manual*, OPNAVINST 5530.14, covers in detail how the security officer performs his or her duties.

The level of training/experience required of the Physical Security Officer varies, depending upon the complexity, size, and mission of the activity. In smaller commands, the security officer position may be a collateral duty requiring only limited security training or experience and may be, in commands of less than 200 personnel, assigned to a senior enlisted (E-7 or above) with appropriate experience or training. In larger commands, installations, and bases, the security officer billet is assigned to a fully trained or experienced commissioned officer or warrant officer and is normally treated as a department head tour.

SECURITY MANAGER

The security manager is the commanding officer's advisor and direct representative in matters pertaining to the security of classified material. In the performance of these duties, the security manager is guided by OPNAVINST 5510.1. The security officer supports the security manager in protecting classified material. The security manager may serve concurrently as the security officer.

SECURITY DEPARTMENT

The security department is comprised of personnel specifically trained, organized, and equipped to provide the security required to protect an activity's assets and is the single most important element of a command's security program.

Security departments may be composed of military, civilian, or contract guards, or any combination thereof. Regardless of the type or composition of the security department, the duties will fall into five basic categories:

1. Protection of life, property, and the rights of individual citizens
2. Enforcement of Federal/local laws, ordinances, rules and regulations
3. Preserving the peace; preventing, detecting, and investigating accidents and crimes; arresting violators; and aiding citizens in emergency situations
4. Preventing or deterring theft, other losses, fire, damage, accidents, trespassing, sabotage or espionage
5. Controlling pedestrian and vehicular traffic

Commands where the security department has both a law enforcement and physical security mission (normally the host activity) should be organized as shown in figure 10-1. The Operations Division is responsible for all security and law enforcement functions, such as patrol, traffic, harbor security, Auxiliary Security Force, and training. The Administration Division is responsible for all administrative functions associated with the Security Department including, but not limited to, physical security, loss prevention, and access control. The Investigations Division is primarily responsible for the investigation of all cases not under the jurisdiction of the Naval Criminal Investigative Service (NCIS) and will maintain a close liaison with the local supporting NCIS Office.

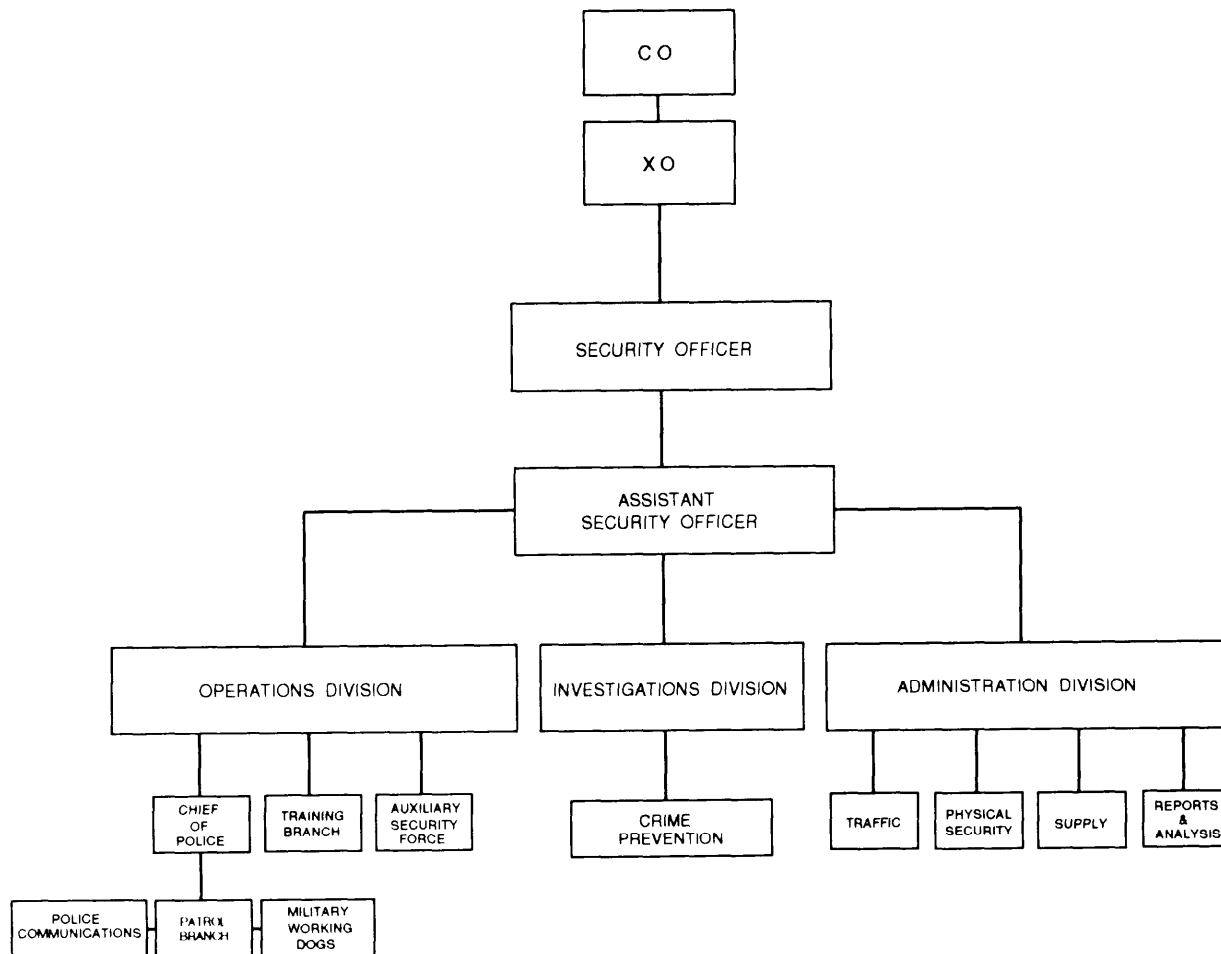

- 1 ASSISTANT SECURITY OFFICER POSITION IS NOT REQUIRED
- 2 A COMMAND MAY IDENTIFY ADDITIONAL DIVISIONS AS REQUIRED BY MISSION
- 3 A COMMAND MAY IDENTIFY ADDITIONAL BRANCHES AS REQUIRED BY MISSION

Figure 10-1.-Security department.

Deputy security officers should be assigned to supervise each of the three major branches—a Deputy Security Officer for Operations (formally Chief of Police); Deputy Security Officer for Administration; and the Deputy Security Officer for Investigations (formally Chief Investigator). Each of the deputies should report directly to the Security Officer.

is not uncommon for the security officer to serve as the security manager or the manager of other specialized security programs. Additionally, the security officer may work directly for the security manager or vice versa, depending upon the nature of the command's mission and/or the predominate type of property held by the command.

ORGANIZATIONAL RELATIONSHIPS

The security officer serves, via the executive officer, as the commanding officer's principal advisor in all matters relating to physical security. Close coordination between the security officer and personnel assigned to other security disciplines, such as the security manager, the automated information security (AIS) officer, and the operations security (OPSEC) officer, is essential for the success of a viable program. In smaller activities, it

SECURITY COMMITTEES

LEARNING OBJECTIVES: Describe the three required forums for day-to-day management of security programs.

Coordination is an important building block in any security program and is essential in its day-to-day

management. In this section, we discuss three of the required and most widely used forums.

PHYSICAL SECURITY REVIEW COMMITTEE

Every naval activity, regardless of size or mission, is required to establish a Physical Security Review Committee (PSRC) to review and discuss security matters as they pertain to that particular command. The PSRC is appointed in writing by the commanding officer or officer in charge and should be chaired by the activity security officer. Membership in the PSRC is normally comprised of the following command personnel:

- Security officer (chairperson).
- Commanding Officer, Marine Corps Security Barracks/Company or, as appropriate, the senior member of the activity Marine Corps cadre.
- Comptroller.
- Security manager and officers or managers of other specialized security programs (for example, base/activity police/guard supervisor, ADP security officer).
- Public works officer or facilities manager.
- Supply officer.
- Legal officer or general counsel.
- Directors/heads of activities/installations and major command functions whose missions are influenced and impacted by security requirements.
- Senior rated Master-at-Arms, or senior designated Master-at-Arms, assigned physical security duties.
- Internal review functional manager.
- Weapons/ordnance officer.
- Naval Criminal Investigative Service. A representative of the NCIS, while not listed in the required membership, should be included.

LOSS PREVENTION SUBCOMMITTEE

In addition to the PSRC, all naval activities are required to establish a Loss Prevention Subcommittee (LPS), which normally meets immediately following the PSRC meeting. Membership within the LPS should consist of at least three PSRC members, including

internal review participation. The purpose of the LPS is to conduct loss trends analysis, review and tabulate losses, determine preventive and disciplinary measures to be taken, and track actions pending. Minutes for the LPS may be appended to those of the PSRC. In commands of less than 200 assigned personnel, the LPS may meet semi annually versus quarterly. As an alternative, membership in the host command's LPS may meet the LPS requirement.

PHYSICAL SECURITY REVIEW BOARD

The physical security review board (PSRB) is very similar in composition and mission to that of the PSRC. It is, however, designed to address security-related matters on a base or installation-wide perspective. The PSRB is chaired by the host command/activity, and its membership is comprised of representatives of all tenant command/activities. The primary goal of the PSRB is the coordination of mutually supportive physical security and loss prevention practices. Minutes from PSRB meetings should be made a matter of record and retained by the host command in the same manner prescribed for PSRC minutes.

COMMAND KEY CONTROL

LEARNING OBJECTIVES: Describe the criteria for selection and the duties of the key control officer, key custodian, and key subcustodian. Explain the purpose of the key control room and the importance of a well-organized key center. Explain the use of lock control seals and the procedure for lockouts.

Command key control is a vital part of a command's physical security program. In this section, we discuss the responsibilities of key control personnel and key control procedures.

KEY CONTROL OFFICER

A command key control officer should be designated in writing by the commanding officer. Personnel selected should have a Secret security clearance, or more ideally, a security clearance equal to the highest level of classified material held at the command. Selecting personnel with a proven ability to organize is also helpful. Smaller commands may find it best to select the security officer/manager as the key control officer because of the close ties to the facility's

emergency services and control. The person selected should have a good working relationship with the security department.

KEY CUSTODIAN

A key custodian should be designated in writing by the key control officer. The person selected should hold a security clearance at least equal to the assets controlled by the key and lock program. Personnel from within the security department are excellent choices because of the focus on working relationships with the security department. In smaller commands, the key custodian and key control officer may be the same person.

KEY SUBCUSTODIANS

Key subcustodians should be designated by their respective department heads or tenant commands and approved in writing by the key control officer. These personnel may be given control of one or more submaster keys, depending upon the need and mission. For example, the fire department may be designated as a key subcustodian and may have access to all facility keys. Departments may be subcustodians, but the mission of one may require a different key application than that of another. Reliability and integrity play very important roles in the selection of a key subcustodian. The security clearance of subcustodians should be equal to the highest classified level of material secured.

CENTRAL KEY ROOM

Duplicate keys, key blanks, padlocks, and key-making equipment should be secured in a central key room according to OPNAVINST 5530.14. Access should be limited to the commanding officer, key control officer, key custodian, and locksmith. This room should have restricted access and be secured when not in use. Key blanks and duplicate keys should be given the same classification protection as the original keys. At commands too small to warrant or require a central key room, a GSA-approved security container with a three-position combination lock may be used to protect duplicate keys, blanks, and associated equipment as described in OPNAVINST 5530.14. Key codes should also be kept in the central key room. These codes should be kept in an authorized security container as previously discussed.

KEY CENTERS

The importance of an effective index-coordinated key center cannot be overstated. These centers should be co-located with 24-hour staffed sites, such as emergency services dispatch centers. Adequate personnel should also be considered when evaluating a key issue point so that any diversions to the issuer's attention will not compromise the program's integrity. Ingress and egress to and from the key issue point should not compromise the dispatcher or operator in any way. Smaller commands located independently from a major facility may not have a 24-hour emergency support center. The key control should be handled by the key control officer or custodian as required by the commanding officer and according to with Navy policy.

LOCK CONTROL SEALS

Inactive or infrequently used gates must be locked and have seals affixed. The approved seal is a car ball end seal, Military Specification MIL-S-23769C. Security personnel should be instructed that lack of free play (approximately one-eighth inch) indicates the possibility of tampering and a follow-up examination of the seal should be conducted. All seals should be serialized and stored in the same manner as keys. All unused seals should be inventoried annually. The security officer should control placement of entrance seals and account for seals on hand, issued, and used.

LOCKOUTS

Lockouts occur when a lock becomes inoperable for some reason; all lockouts involving restricted areas or buildings should be investigated by security personnel. The investigation should determine if the failure occurred because of lock malfunction or as a result of attempted or actual unlawful entry.

SECURITY INSPECTIONS

LEARNING OBJECTIVES: Explain the importance of security inspections and the reporting requirements for security inspections. Describe quarterdeck inspections, administrative inspection of vehicles, and the exemption for NCIS personnel.

Each naval activity must establish a system for the daily after hours checking of restricted areas, facilities, containers, and barrier or building ingress and egress

points to detect any deficiencies or violations of security standards. Security deficiencies or violations found during after hour checks should be reported to the activity security officer, the department involved and the commanding officer. These incidents should also be reported to activity departments or other local elements having security responsibilities within specific security programs affected by the incident. Each deficiency or violation should be followed up by the activity security officer, and a record kept of all actions taken (structural, security, disciplinary, administrative, and so on) by the responsible department or other organizational elements involved to resolve the present deficiency or violation and to prevent recurrence. All security deficiencies, violations, breaches of security rules and regulations, and criminal incidents discovered and handled by the security force will be recorded on OPNAV Form 5527/1.

QUARTERDECK INSPECTIONS

Quarterdeck inspections should be conducted according to OPNAVINST 3120.32. No person should refuse to present for inspection by the OOD/authorized personnel or Master-at-Arms any item of baggage or article in his or her possession or on his or her person or knowingly conceal in any container or on his or her person any article with intent to deceive or evade the lawful inspection of such articles.

ADMINISTRATIVE INSPECTION OF VEHICLES

All vehicles on naval installations are subject to administrative inspection according to procedures authorized by the commanding officer. As ordered and directed by the commanding officer, authorized security personnel will, while in the performance of assigned duties, administratively inspect vehicles entering or leaving the installation. Such inspections are deemed reasonably necessary to protect the premises, material, and utilities from loss, damage, or destruction.

Because important constitutional questions are involved, no person or group maybe exempted from, or singled out for, such inspections. And the instruction by commanding officers regarding such inspections should be coordinated in advance of implementation with the local JAG or Naval Legal Service Office officials to ensure strict adherence to a structured random inspection pattern.

At the minimum, guards should be instructed that incoming persons and automobiles may not be inspected over the objection of the individual. However, those

who refuse to permit inspection should not be allowed to enter. Persons who enter should be advised in advance (a properly worded sign to this effect prominently displayed in front of the access point will suffice) that they and their vehicles are subject to inspection while on board the installation and upon departure. Persons who refuse to submit their vehicle to an authorized inspection while on board or upon departure may be detained long enough to obtain a warrant for search of the vehicle, issuance of a letter barring future entrance to the installation, or such other action as may be appropriate.

EXEMPTION FOR NAVAL CRIMINAL INVESTIGATIVE SERVICE

NCIS personnel and their vehicles, used in the course of official business, are exempt from administrative inspection of vehicles upon presentation of a badge and/or credentials when entering or leaving Navy installations.

PERIMETER AND AREA PROTECTION AND CONTROL

LEARNING OBJECTIVES: Explain the reason for conducting a risk and threat analysis. Explain the concept of enclaving. Describe the two types of area designations.

Before a decision to use security measures is made, a thorough risk and threat analysis should be performed to determine the degree of physical security required. As reflected in paragraph 0203 of OPNAVINST 5530.14: "In certain cases, extensive and costly security measures may be necessary to protect certain items of security interest. However, in each case the commanding officer of an activity is responsible for complying with established security requirements while at the same time working to achieve economy. To achieve this objective, higher echelon security requirements must be clearly understood. Additionally, the relative criticality and vulnerability of the security interest must be evaluated in relation to a ranking of potential threats, and a specific level of security must be calculated to ensure the best possible protection for that threat level in a cost-effective manner." Only after these preliminary factors are addressed can proper controls be instituted.

Installation or perimeter and area protective controls are the first steps in providing actual protection

against certain security hazards. These controls are obtained through the use of protective barriers and other security measures. They are intended to define the installation/activity/area boundaries and are used to channel personnel and vehicular access. Security barriers may be natural or structural and are addressed in chapter 6 of OPNAVINST 5530.14.

ENCLAVING (ISLAND) SECURITY CONCEPT

Enclaving is the preferred method for securing relatively small restricted areas at specific sites within an installation. These areas include naval readiness or other critical assets requiring a higher degree of protection than the installation itself. Enclaving involves segregating certain areas and concentrating security resources for these areas, which is generally more cost-effective than fencing the entire perimeter. For instance, a restricted area may be enclaved by a separate fence, lighting, or alarm system, without fencing the entire installation perimeter.

As in the case for the protection of arms, ammunition, and explosives according to OPNAVINST 5530.13, installing standard chain link fencing around the entire outer perimeter of certain naval installations may not be consistent with attempts by the Federal government to retrocede legislative jurisdiction to state authorities for certain areas aboard naval installations. Examples include Navy and Marine Corps exchanges and financial, recreational, and medical facilities.

Enclaving does not eliminate the requirement to identify and post installation perimeters. This could be accomplished by installing alternate fencing, such as two- to four-strand barbed wire.

Installations that elect to adopt enclaving to protect assets as a temporary or permanent alternative to required perimeter standard fencing must submit a waiver or exception request per paragraph 0116 of OPNAVINST 5530.14. Requests must indicate the type of perimeter fencing planned and/or other compensatory security measures planned or in place.

AREA DESIGNATIONS

Different areas and tasks require different degrees of security interest depending upon their purposes, nature of the work performed within, and the information and/or materials concerned. For similar reasons, different areas within an activity may have varying degrees of security importance. To address these situations, facilitate operations and simplify the

security system. A careful application of restrictions, controls, and protective measures commensurate with varying degrees or levels of security importance is essential. In some cases, the entire area of an activity may have a uniform degree of security importance requiring only one level of restriction and control. In others, differences in the degree of security importance will require further segregation of certain security interests.

Areas will be designated as either restricted areas or nonrestricted areas. Restricted areas are established in writing by a commanding officer within his or her jurisdiction. These areas are established "pursuant to lawful authority and promulgated pursuant to DOD Directive 5200.8, dated 29 July 1980 (enclosed in SECNAVINST 5511.36), and Section 21, Internal Security Act of 1950; Ch. 1024, 64 stat. 1005; 50 U.S.C. 797)."

Now let's look at restricted and nonrestricted areas in more detail.

RESTRICTED AND NONRESTRICTED AREAS

LEARNING OBJECTIVES: Identify and explain the three types of restricted areas. Define a *nonrestricted area*.

Three types of restricted areas are established in descending order of importance—Level Three, Level Two, and Level One. All restricted areas should be posted simply as Restricted Areas (according to sign provisions set forth in the following paragraphs) so as not to single out or draw attention to the importance or criticality of an area. While restricted areas often pertain to the safeguarding of classified information, there are other valid reasons to establish restricted areas, such as mission sensitivity; protection of certain unclassified chemicals; precious metals or precious-metal-bearing articles; conventional arms, ammunition and explosives; funds; drugs; nuclear material; sensitive or critical assets; or articles having high likelihood of theft.

LEVEL THREE (FORMERLY EXCLUSION AREA)

Level Three is the most secure type of restricted area. It may be within less secure types of restricted areas. It contains a security interest that, if lost, stolen, compromised or sabotaged, would cause *grave damage* to the command mission or national security. Access to

the Level Three restricted area constitutes, or is considered to constitute, actual access to the security interest or asset.

LEVEL TWO (FORMERLY LIMITED AREA)

The second most secure type of restricted area is Level Two. It may be inside a Level One area, but is never inside a Level Three area. It contains a security interest that, if lost, stolen, compromised, or sabotaged, would cause *serious damage* to the command mission or national security. Uncontrolled or unescorted movement could permit access to the security interest.

LEVEL ONE (FORMERLY CONTROLLED AREA)

Level One is the least secure type of restricted area. It contains a security interest that, if lost, stolen, compromised, or sabotaged, would cause *damage* to the command mission or national security. It may also serve as a buffer zone for Level Three and Level Two restricted areas, thus providing administrative control, safety, and protection against sabotage, disruption, or potentially threatening acts. Uncontrolled movement may or may not permit access to a security interest or asset.

NONRESTRICTED AREAS

A nonrestricted area is an area, under the jurisdiction of an activity, where access is either minimally controlled or uncontrolled. Such an area may be fenced or open to uncontrolled movement of the general public. An example of a nonrestricted area is a visitor or employee parking lot that is open and unattended by guards. After business hours it may be closed patrolled, and converted to a restricted area. Another example is a personnel office where the general public is permitted access during business hours without being required to check in or register with the security office. A nonrestricted area maybe an area enclosed by a fence or other barrier, where access is minimally controlled by a checkpoint only, ensuring that the visit or access was for an authorized purpose. In such cases, further security authorization (a security clearance) would not be required for access. A housing area exterior to the base would normally be designated as a nonrestricted area. Nonrestricted areas should not be located inside restricted areas.

Many activities and installations have areas containing a number of facilities where members of the Armed Forces and their dependents, as well as civilian

employees and their families, are permitted access by displaying vehicle decals or by presenting appropriate identification cards (not issued on the basis of security clearance or similar screening, but by virtue of employment or status). These facilities include exchanges, commissaries, administrative offices, dispensaries, clubs, recreational facilities, and so on. Areas containing these facilities on activities and installations will normally be designated as nonrestricted areas. However, these facilities themselves may have internal spaces that will, of necessity, be designated as restricted areas.

MINIMUM SECURITY MEASURES

LEARNING OBJECTIVES: List and explain the minimum security measures for each type of restricted area. Explain the general security measures taken within restricted areas.

Each type of restricted area requires a certain minimum level of protection. Except as indicated in OPNAVINST 5530.14, classification of each type of restricted area is the responsibility of the commanding officer. Now let's consider the minimum security measures required for each level.

LEVEL THREE SECURITY MEASURES

The following minimum security measures are required for Level Three restricted areas:

- A clearly defined protected perimeter. The perimeter may be a fence, the exterior walls of a building or structure, or the outside walls of a space within a building or structure. If the perimeter is a fence, it should be posted at no less than 100-foot intervals along the perimeter. Barrier and lighting requirements are set forth in chapters 6 and 7 of OPNAVINST 5530.14. If the perimeter is a wall, it should be posted at the point of ingress.
- A personnel identification and control system, including an access list and entry and departure log. Only visitors need be logged in and out during normal duty hours. After normal duty hours, all personnel should be logged in and out.
- Ingress and egress controlled by guards or appropriately trained and cleared personnel. When secured, access to the area should be controlled by an intrusion detection system or security personnel.

- Admission only to persons whose duties require access and who have been granted appropriate authorization. Persons who have not been cleared for access to the security interest contained within a Level Three restricted area may, with appropriate approval, be admitted to such area, but they should be controlled by a cleared activity or facility escort at all times and the security interest protected from compromise.

- When secured, the area should be checked at least twice per 8-hour shift, or at least once per 8-hour shift if adequately equipped with an operational intrusion system. The security force should check for signs of attempted or successful unauthorized entry and for other activity that could degrade the security of the Level Three restricted area.

LEVEL TWO SECURITY MEASURES

The following minimum security measures are required for Level Two restricted areas:

- A clearly defined and protected perimeter. The perimeter may be a fence, the exterior walls of a building/ structure or the outside walls of a space within a building/structure. If the perimeter is a fence, it should be posted at no less than 100-foot intervals along the perimeter. If the perimeter is a wall, it should be posted at the point of ingress.

- A personnel identification and control system. During normal duty hours, use of an access list and entry and departure log is suggested but not required. After normal duty hours, all personnel should be logged in and out. (An electronic control system with the capability of recording ingress and egress may be used to accomplish this.) If a computer access control or logging system is used, it should be safeguarded against tampering.

- Both ingress and egress should be controlled by guards, receptionists, or other appropriately trained and cleared personnel and secured during nonworking hours.

- Admission should be granted only to persons whose duties require access and who have been granted appropriate authorization. Persons not cleared for access to the security interest contained within a Level Two restricted area may, with appropriate approval, be admitted, but they should be controlled by a cleared activity escort at all times, and the security interest protected from compromise.

- When secured, the area should be checked at least twice per 8-hour shift or at least once per 8-hour

shift if adequately equipped with an operational intrusion system. The security force should check for signs of attempted or successful unauthorized entry and for other activity that could degrade the security of the Level Two restricted area.

LEVEL ONE SECURITY MEASURES

The following minimum security measures are required for Level One restricted areas:

- A clearly defined protected perimeter. The perimeter may be a fence, exterior walls, or outside walls of a space within a building or structure. If the perimeter is a fence, it should be posted at no less than 100-foot intervals along the perimeter. If the perimeter is a wall, it should be posted at the point of ingress.

- A personnel identification and control system.

- Ingress and egress controlled by guards, receptionists, or other appropriately trained and cleared personnel.

- Controlled admission of individuals (military, civil service, contractors, official visitors) who require access for reasons of employment or official business, individuals who render a service (vendors, delivery people), dependents, retired military, and unofficial visitors (guests of residents, visiting softball team). Individuals without adequate identification, as determined by the local commanding officer, should be logged in and out.

GENERAL SECURITY MEASURES

Certain facilities and assets identified as critical and essential to the overall mission of the Navy and Marine Corps and national security have been identified in appendix IX of OPNAVINST 5530.14. Restricted area designations have been assigned in addition to specific physical security requirements to provide optimum protection.

All instructions designating restricted areas should include procedures for conducting inspections of persons and vehicles entering and leaving such areas. The purpose is to detect and prevent the introduction of prohibited items (firearms, explosives, and drugs) and to detect and prevent the unauthorized removal of government property and material. To be effective, administrative vehicle and personnel inspection operations should be conducted daily on a random basis. As a minimum, the activity's security officer should make sure they are conducted at least weekly.

Procedures should be coordinated with the cognizant Staff Judge Advocate or Naval Legal Service Office and approved by the activity commanding officer or designated representative.

LIMITED WATERWAY AREAS

LEARNING OBJECTIVES: List and define four types of limited waterway areas. Determine the agency responsible for each area and list the authority, limitations, penalties, enforcement, and threat required.

Installation/activity commanding officers should ensure their waterfront and waterway areas are designated by proper authority. Commanding officers of installations/activities adjacent to waterways having, or seeking to establish, control mechanisms to limit persons, vehicles, vessels and objects within designated areas have several options. This section describes the different types of limited waterway areas available based on the level of threat. The U.S. Coast Guard (USCG) and U.S. Army Corps of Engineers (USACE) may, when safety, security, or other national interests dictate, control access to and movement within certain areas under their jurisdiction.

Table 10-1 describes the area, agency, authority, limitations, penalties, and enforcement of the four types of limited waterway areas. The Comments section of table 10-1 provides information regarding threat justification. For more information on limited waterway areas, see OPNAVINST 5530.14.

Commanding officers should make every effort to coordinate protection of adjacent waterway areas with the proper agency, and they should also review operations and security plans to make sure areas of responsibility are properly identified. Liaison between security personnel and local Coast Guard officials should be maintained to ensure designation of limited waterway areas and that procedural aspects are kept current.

SIGNS AND POSTING OF BOUNDARIES

LEARNING OBJECTIVES: Determine the size, color and posting points for ingress and perimeter barrier signs for both restricted and nonrestricted areas.

Restricted areas, including buildings, should be posted at regularly used external points of ingress with

signs approximately 3 feet by 3 feet, with proportionate lettering. Signs should read as follows:

WARNING

RESTRICTED AREA - KEEP OUT

AUTHORIZED PERSONNEL ONLY

AUTHORIZED ENTRY INTO THIS RESTRICTED AREA CONSTITUTES CONSENT TO SEARCH OF PERSONNEL AND THE PROPERTY UNDER THEIR CONTROL.

**INTERNAL SECURITY ACT OF 1950
SECTION 21; 50 U.S.C. 797**

Criteria for identifying internal points of ingress into designated restricted and nonrestricted buildings are contained in OPNAVINST 5510.1.

Perimeter barriers of all restricted areas should be posted with signs measuring approximately 12 inches by 18 inches, with proportionate lettering. Signs should read as follows:

WARNING

RESTRICTED AREA

KEEP OUT

Authorized Personnel Only

Nonrestricted areas should be posted at all points of ingress with signs approximately 3 feet by 3 feet, with proportionate lettering. Signs should read as follows:

WARNING

U.S. NAVY PROPERTY

AUTHORIZED PERSONNEL ONLY

AUTHORIZED ENTRY ONTO THIS INSTALLATION CONSTITUTES CONSENT TO SEARCH OF PERSONNEL AND THE PROPERTY UNDER THEIR CONTROL.

**INTERNAL SECURITY ACT OF 1950
SECTION 21; 50 U.S.C. 797**

Perimeters of nonrestricted areas should be posted with signs measuring approximately 11 inches by 12 inches, with proportionate lettering. Signs should read as follows:

U.S. GOVERNMENT PROPERTY

NO TRESPASSING

Table 10-14-Limited Waterway Areas

LIMITED WATERWAY AREAS						
AREA	AGENCY	AUTHORITY	LIMITATIONS	PENALTIES	ENFORCEMENT	COMMENTS
*RESTRICTED AREA	USACE(1)	33 CFR 207	Only on inland waters.	Misdemeanor	Enforcement can be delegated to the Navy command.	No threat needed. Easy to obtain. Provides limited area jurisdiction for command.
*SAFETY ZONE	USCG/ COTP(2)	33 CFR 165	Temporary, but may be long term	Misdemeanor Can result in civil or criminal penalties under 33 USC 1232.	USCG only. Navy may patrol. COTP authority.	No threat needed. Can be placed around "moving" vessel.
*SECURITY ZONE	USCG/ COTP	Magnuson Act (50 USC 191)/ 33 CFR 6.10-5, 33 CFR 165	Only within territorial limits of United States. No person or vessel may enter zone without permission from COTP. Can be placed overland.	Felony - 10 years/\$10,000	USCG only. Navy may patrol under COTP authority.	Threat required. COTP controls access and movement of all vessels, persons & vehicles (including their removal), and may take possession and control of any vessel. (See 33 CFR 165.33.)
*RESTRICTED WATERFRONT AREAS	USCG/ COMDT (3)	Magnuson Act (50 USC 191) 33 CFR 165.40	Must be issued and directed by Commandant of the Coast Guard. COTP may be directed to enforce. Must be in regulations. Limits access of persons.	Felony - 10 years/\$10,000	USCG only. COTP directed by COMDT.	Threat required. Long-term limited access area. Any change must be directed by the COMDT.
(1) USACE - U.S. Army Corps of Engineers (2) COTP - Coast Guard Captain of the Port (3) COMDT - Commandant of the Coast Guard * Does not include airspace						

Where a language other than English is prevalent, restricted and nonrestricted area warning notices should be posted in both languages.

The interval between signs posted along restricted and nonrestricted area perimeters should not exceed 200

feet. All barrier signs should be placed so as not to obscure the necessary lines of vision for security force personnel.

All signs should be color-coded to provide legibility from a distance of at least 100 feet during daylight under

normal conditions. The following color codes are recommended for installation/activity and restricted/nonrestricted area perimeter signs:

- All words except *WARNING* should be black.
- The word *WARNING* should be red.
- All wording should be on red, white, and/or blue backgrounds, as appropriate, to obtain maximum color contrast.

Warning signs not worded as prescribed in the previous paragraphs should be replaced. Waivers/exceptions are not required.

PROTECTIVE LIGHTING

LEARNING OBJECTIVES: Explain the purpose and value of protective lighting. Identify nine basic principles of protective lighting. Evaluate three types of protective lighting systems. Explain the power requirements for emergency lighting systems.

Protective lighting provides a means of continuing a degree of security approaching that which is maintained during daylight hours. It increases the effectiveness of security forces performing their duties, has considerable value as a deterrent to thieves and vandals, and may make the job of the saboteur or terrorist more difficult. Requirements for protective lighting at an activity depend upon the situation and the areas to be protected. In the interest of finding the best possible mix between energy conservation and effective security, each situation must be carefully studied. The overall goal is to provide the proper environment to perform duties such as identification of badges and personnel at gates and inspection of unusual or suspicious circumstances. Where lighting is impractical, additional compensating measures should be instituted.

GENERAL PRINCIPLES AND GUIDELINES

NAVFAC MIL-HDBK-1013/1 provides general principles and guidelines for exterior protective lighting. These guidelines, including table 25 and table 26 of this reference, should be applied by activities when determining protective lighting requirements. When protective lighting is installed and used, the previous guidelines and the following basic principles should be applied:

- Provide adequate illumination or compensating measures to discourage or detect attempts to enter restricted areas and to reveal the presence of unauthorized persons within such areas.

- Avoid glare that handicaps security force personnel or is objectionable to air, rail, highway or navigable water traffic or occupants of adjacent properties.

- Locate light sources so that illumination is directed toward likely avenues of approach and provides relative darkness for patrol roads, paths, and posts. To minimize exposure of security force personnel, lighting at entry points should be directed at the gate and the guard should be in the shadows. This type of lighting technique is often called *glare projection*.

- Illuminate shadowed areas caused by structures within or adjacent to restricted areas.

- Design the system to provide overlapping light distribution. Equipment selection should be designed to resist the effects of environmental conditions, and all components of the system should be located to provide maximum protection against intentional damage.

- Meet requirements of blackout and coastal dimout areas.

- Avoid drawing unwanted attention to restricted areas.

- During planning stages, consideration should be given to future requirements of closed circuit television (CCTV) and recognition factors involved in selection of the type of lighting to be installed. Where color recognition will be a factor, full spectrum (such as high-pressure sodium vapor) lighting vice single color should be used.

- Choose lights that illuminate the ground or water but not the air above. These lights must penetrate fog and rain.

TYPES OF PROTECTIVE LIGHTING SYSTEMS

There are several types of protective lighting systems in use today. Each should receive consideration by the command based on their requirements. We will touch on three of these systems: continuous, standby, and movable. We will also discuss some emergency power requirements.

Continuous Lighting

The most common protective lighting system is a series of fixed lights arranged to flood a given area continuously with overlapping cones of light. The two primary methods of employing continuous lighting are glare projection and controlled lighting.

GLARE PROJECTION LIGHTING.— Glare projection lighting uses lights slightly inside a security perimeter and directed outward. This method is useful where the glare of lights directed across surrounding territory will neither annoy nor interfere with adjacent operations. It is a deterrent to potential intruders because it makes it difficult to see inside the area being protected. It also protects security personnel by keeping them in comparative darkness and enabling them to observe intruders at a considerable distance beyond the perimeter.

CONTROLLED LIGHTING.— Controlled lighting is best used when it is necessary to limit the width of the lighted strip outside the perimeter because of adjoining property or nearby highways, railways, navigable water, or airports. The width of the lighted strip can be controlled and adjusted to fit a particular need, such as illumination of a wide strip inside a fence. Care should be taken to minimize or eliminate silhouetting or illuminating security personnel on patrol.

Standby Lighting

A standby system differs from continuous lighting insofar as its intent is to create an impression of activity. The lights are not continuously lighted, but are either automatically or manually turned on randomly or when suspicious activity is detected or suspected by security personnel or intrusion system. Lamps with short restart times are essential if this technique is chosen. This technique may offer significant deterrent value while also offering economy in power consumption.

Movable Lighting

Movable lighting (stationary or portable) consists of manually operated searchlights that may be lighted during hours of darkness or as needed. This system is normally used to supplement continuous or standby lighting.

EMERGENCY LIGHTING

Emergency lighting may duplicate any or all of the previous systems. Its use is limited to times of power

failure or other emergencies that render the normal system inoperative. It depends on alternative power sources, such as installed or portable generators or batteries.

PROTECTIVE LIGHTING PARAMETERS

LEARNING OBJECTIVES: List five criteria that commanding officers should use to determine protective lighting requirements. Explain the minimum standards for protective lighting and the need for an emergency power source. Identify the technical aspects and describe switch and control protection for protective lighting systems.

The commanding officer must decide what other areas or assets to illuminate and how to do it. This decision should be based upon the following criteria:

- Relative value of items being protected
- Significance of the items being protected in relation to the activity mission and its role in the overall national defense structure
- Availability of security forces to patrol and observe illuminated areas
- Availability of fiscal resources (procurement, installation, and maintenance costs)
- Energy conservation

MINIMUM STANDARDS

Unpatrollable fence lines, water boundaries, and similar areas need not be illuminated. Where these areas are patrolled, sufficient illumination should be provided to assist the security force in preventing intrusion.

Vehicular and pedestrian gates used for routine ingress and egress should be sufficiently illuminated to facilitate personnel identification and access control.

Exterior building doors should be provided with lighting to enable the security force to observe an intruder seeking access.

Airfields, aircraft, shipyards, controlled industrial areas, piers, docks, petroleum storage areas, and other mission-critical areas should be protected with sufficient illumination for the security force to detect, observe, and apprehend intruders.

Protective lighting should be checked daily by the security force to ensure all light fixtures are operational. Inoperative lights should be recorded and referred to the security officer.

The security officer should make sure all reports of inoperative protective lights are given immediate attention and corrective actions are taken.

EMERGENCY POWER

Restricted areas provided with protective lighting should have an emergency power source located within the restricted area. The emergency power source should be adequate to sustain security lighting and communications requirements and other essential services required within restricted areas. Provisions should be made to ensure the immediate availability of the emergency power in the event of failure of the primary source. Emergency power sources should start automatically. Battery-powered lights and essential communications should be available at all times at key locations within the restricted areas in the event of complete failure of primary and emergency sources of power. Emergency power systems should be tested monthly and the results should be recorded/logged and maintained for a period of 3 years or until the next cognizant Inspector General command inspection cycle, whichever is greater.

TECHNICAL ASPECTS

The differences in building arrangements, terrain, atmospheric conditions, and other factors necessitate the designing of each protective lighting system to meet the conditions peculiar to each activity or facility.

Protective illumination should not be curtailed below the minimum required for security. Lack of illumination contributes to increases in loss and vandalism that can more than offset energy costs. In designing a lighting system, consideration should be given to local conditions at the installation or activity, with efforts concentrated on reducing the amount of energy used to deliver the illumination required by taking advantage of all lighting energy conservation opportunities (LECO). LECO should be evaluated in terms of existing systems in the area and future requirements.

A lighting energy audit should be conducted to learn what is installed, the condition, the energy being consumed, the light produced, the amount of light needed, and so forth, to determine which type of lamp (incandescent, fluorescent, mercury vapor, metal halide,

high-pressure sodium, or low-pressure sodium) system or systems would be best.

New system interactions should be evaluated with existing systems in adjacent areas to determine impact (other light levels, electrical transmission systems, heating and cooling systems, and so on).

Multiple circuits may be used to an advantage in protective lighting systems. The circuits should be so arranged that the failure of anyone lamp will not darken a long section of a critical or vulnerable area. The protective lighting system should be independent of other lighting systems and should be protected so that a fire or disaster will not interrupt the entire system.

SWITCH AND CONTROL PROTECTION

Controls and switches for protective lighting systems should be inside the protected area and locked or guarded at all times. An alternative is to locate the controls in a central station similar to, or as a part of, the system used in intrusion detection alarm central monitoring stations. High-impact plastic shields may be installed over lights to prevent destruction by stones, air rifles, and so on.

PHYSICAL SECURITY SURVEYS

LEARNING OBJECTIVES: List and explain the purpose of a physical security survey. Describe the three types of physical security surveys.

Each Navy activity and installation should establish a program to assess the degree of local compliance with the security standards, requirements, and policies on an annual basis. The physical security survey checklist contained in appendix VIII of OPNAVINST 5530.14 should be used. Command inspections or special-purpose (physical security inspection/physical security audit/physical security review) examinations of an activity's security program should be conducted by an immediate superior in command at least every 3 years. This survey should include the practical exercise of physical security, loss prevention, and crisis management plans to evaluate the overall adequacy of the security force. It should also evaluate the activity's ability to protect against penetration of its barriers and unauthorized entry, protect vital property, and deal with terrorist situations.

PURPOSE OF PHYSICAL SECURITY SURVEYS

Physical security surveys are used to evaluate the adequacy of a command's security program. The security officer should initiate physical security surveys, which may be conducted by rated Master-at-Arms, trained civilian employees, or security guard force personnel. Physical security surveys should be conducted at least once annually. These surveys should identify all security discrepancies and make recommendations for corrective actions. Additionally, a POA&M should be developed to assist in the tracking of corrective actions taken and pending.

A physical security survey is made to verify current information and to obtain new facts. It should be conducted not only during normal duty hours but also during nonduty hours, including hours of darkness. If done correctly, the survey will provide a true picture of the existing hazards and effectiveness of current protective measures. Physical security surveys should be used as a management tool and are not normally sent up the chain of command.

TYPES OF PHYSICAL SECURITY SURVEYS

Three types of physical security surveys are used on installations: initial, supplemental, and follow-up. Each is discussed in turn.

Initial Survey

The *initial* survey is the very first survey of an installation and is conducted by the responsible surveying office.

Supplemental Survey

A *supplemental* survey is conducted when changes occur in the organization, mission, or physical aspects that would affect physical security of the installation.

Follow-up Survey

The *follow-up* survey is made to ensure recommendations from the initial and supplement surveys have been carried out. It is important to make sure work orders are initiated and stay valid.

CONTROL OF PERSONNEL

LEARNING OBJECTIVES: Describe seven types of personnel identification systems and the characteristics of each. Explain standard re-badging and badge expiration dates. Explain expiration dates for permanent picture, military permanent, and contractor picture badges. Describe 6 standards and 10 characteristics of passes and badges. Explain key card control.

The reason for establishing a personnel control system is to provide a visible means to track and identify personnel who are authorized access to certain areas and to deny access to those who are not authorized. The degree of control should be in keeping with the sensitivity, classification, or operational importance of the area. It is important to keep the procedures simple. Visitor control should be in compliance with OPNAVINST 5510.1.

PERSONNEL IDENTIFICATION SYSTEMS

The following types of personnel identification systems may be used independently or in conjunction with each other:

- **Military/Dependent Identification Cards.** May be used as a medium to identify personnel authorized access to areas that do not have security implications (nonrestricted areas). This system is considered the least reliable means for determining access authorization.

- **U.S. Government Identification Card.** Civil service employees may be issued U.S. Government Identification Cards, Optional Form 55, to identify civilian employees and may be used as a means to authorize access into areas that do not have security implications.

- **Personal Recognition:** The most positive method of identification and should be used in areas where the number of authorized personnel does not exceed 50.

- **Access List System.** Admission of individuals to restricted areas should be granted to only those persons who are positively identified. To assist in their identification process, access lists may be used to control access into Level 1 and Level 2 areas, and are required in all Level 3 areas. Access lists should be maintained and kept under stringent control of an individual who is formally designated by the commanding officer. Lists must be protected from

public view and, if a computerized system is used, it should be safeguarded against tampering.

- **Pass and Badge System.** For access to large areas or where the number of personnel exceeds that allowed for personal recognition, a pass and badge system should be used. This system is considered the most practical means of identification to be used by large activities. Minimum badging standards and criteria are contained in chapter 5 of OPNAVINST 5530.14.

- **Exchange Pass System.** The exchange pass system is employed in highly sensitive areas (Levels One and Two restricted areas). It involves exchanging one or more identification media (badges, passes, and so on) for another type of identifier.

- **Escort System.** Escorting is a method of identifying and controlling personnel within a security area who are not normally authorized access to that area. The assigned escort should remain with the visitor at all times while he or she is within the security area.

STANDARD RE-BADGING

Installations and activities should re-badge all regular employees and other personnel possessing permanent picture badges every 6 years or when a loss of 6 percent is attained, whichever occurs first.

A loss of 6 percent is the maximum acceptable standard for the reissue of permanent picture identification badges. To compute the percentage of lost permanent badges, divide the number of lost permanent badges by the number of permanent badges issued over a given period of time, normally from the beginning of the current 6-year time period. Losses totaling 6 percent or more require re-badging.

New permanent picture badges should be distinctly different from those replaced.

BADGE EXPIRATION DATES

All issued security badges and passes should bear an expiration date. The expiration date should be conspicuously displayed on the face of the badge or pass and should be distinguishable from a distance of 3 feet during normal daylight hours. Now let's look at expiration dates for permanent picture, military permanent, and contractor picture badges.

Permanent Picture Badges

All permanent picture badges issued during a 6-year period to nonmilitary personnel should bear the same expiration date. For example, badges issued during a 6-year period ending in December 1993 would normally bear a December 1993 expiration date. If unscheduled re-badging is required during any 6-year cycle, a new 6-year cycle would start from the date of the unscheduled re-badging and expiration would be 6 years from that date.

Military Permanent Badges

All permanent picture badges issued to military personnel stationed on an activity should expire at the end of their projected rotation date (PRD), expiration of TAD, TEMDUINS or TDY, or expiration of active obligated service (EAOS), whichever occurs first.

Contractor Picture Badges

Contractor picture badges should expire at the completion of the current contract or 24 months, whichever occurs first.

PASS AND BADGE STANDARDS

The following guidelines apply when a pass or badge system of identification is necessary:

- An activity's permanent ID pass or badge must contain all of the characteristics listed below and set forth in OPNAVINST 5530.14.

- A temporary pass or badge need not contain all of the characteristics listed below, since it only provides control of visitors and personnel who visit infrequently. However, the badges should be rigidly controlled and accounted for by individual serial number, should be distinctly different in style and design from permanent passes or badges used by an activity, and should clearly indicate the period and limits of authorized use.

- Pass and badge format may be designed locally. Economy should be considered. The design agency should bear in mind that the primary purpose of an identification system is to control access to specific areas and alert personnel of the presence of unauthorized persons in the area. Bold print; large, recent photographs; a distinctive design; and tamper-resistant structures are prime considerations.

- The "exchange badge system" should be employed where security requirements dictate.

- The printer's plates for passes or badges should be obtained and safeguarded to avoid compromise. When necessary, the pass system may be changed by reprinting in different colors or reformatting the pass.

- The badge or pass form should be serialized controlled, and protected. The issuing activity should conduct an inventory of all serially numbered badges and passes on hand at least semiannually and should establish written procedures for retrieval and destruction of invalid badges and passes from personnel whose access has been terminated.

PASS AND BADGE CHARACTERISTICS

The following characteristics apply to permanent passes or badges:

- Size, which is generally consistent with other standard identification cards.

- A photograph; minimum size is 1 inch by 1 1/4 inch (same as military ID card). The maximum size should be consistent with economy, available equipment, and pass or badge design. The photograph should be in color, stress facial features, and should not include the area below the neck.

- A clear space at the top of the pass or badge to place a hole for an attachment device.

- A serial number for accountability.
- Name of holder, typewritten or printed.
- Signature of holder.
- Name, rank, and title of validating officer.
- Signature of validating officer.
- Expiration date of pass/badge.

- The following statements are required and may be incorporated in the badge design or be an overlay on the lamination. They may be combined:

“U.S. Government Property.”

“Loss of this card must be reported at once”

“If found, drop in nearest U.S. mailbox.”

“Postmaster: Postage Guaranteed. Return to Commanding Officer, (address of the issuing activity indicated on face of badge).”

“Warning - issued for official use of the holder designated hereon. Use or possession by any other person is unlawful and will make the offender liable

to penalty - 18 U.S.C. 499, 506, 701.” (Reference should be made to the Status of Forces Agreements for overseas activities only.)

Security construction requirements should include heat seal adhesion of the complete card to prevent photographic reproduction. An identifying logo or validation seal or initials should be manufactured into the lamination along with other positive security measures that will help prevent tampering. Identifying information should be clearly legible to security personnel at a distance of 1 meter in normal lighting conditions.

KEY CARDS

Where card readers are used to control access, procedures for removal or invalidation of lost key cards from the system and changes to personnel identification numbers for associated digital key pads should be included.

CONTROL OF VEHICLES

LEARNING OBJECTIVES: Explain how the vehicle decal is used to control privately owned vehicles and how decals are used in overseas areas. Describe how passes are used for visitor control. Explain why vehicle passes issued by other activities are honored. Describe the special precautions that should be considered in vehicle control.

Directly related to the movement and access control of personnel is the control of various privately owned motor vehicles. The standard Navy Decal, DD Form 2220, is the media used to identify and control motor vehicles on most installations. Whatever media is used, it should serve as a rapid means of identifying the vehicle as having authority for being operated and parked on the installation. It should not be used as a mean to identify the driver or any occupant.

APPLICATION OF DECALS IN OVERSEAS AREAS

Certain overseas activities and other locations where terrorist activity is acute and ongoing may be exempt from the provisions of this requirement and OPNAVINST 5560.10 and OPNAVINST 11200.5. Stronger emphasis should be placed on positive identification and control of vehicles and occupants

entering installations and activities exempt from the requirement to display vehicle decals. At small activities, the use of vehicle access lists could be employed to provide positive vehicle identification. The use of portable decals displayed on the windshield of vehicles is discouraged because of potential theft and illegal use of these decals. Personal recognition continues to be the best method of identification and should be used whenever possible. Those activities meeting this criteria and desiring to be exempt must obtain an exception to the requirement, according to paragraph 0116 in OPNAVINST 5530.14.

VISITOR CONTROL

Vehicles requiring only temporary access may be issued locally produced temporary vehicle passes. A large card displayed on the sun visor or windshield may be used as a temporary pass.

A temporary pass may be printed in several colors that can be changed periodically to detect unauthorized use. In addition to identification information, the following warning should be included:

Acceptance of this pass constitutes your consent to inspection of this vehicle and occupants therein by security force personnel when entering, aboard, or leaving this station. Visitors aboard this installation are guests of the commanding officer and, as such, should conduct themselves in accordance with the limited conditions under which the invitation is extended. Political activities, pamphleteering, speeches, demonstrations, placard/banner displays, or other similar conduct will not be permitted without prior written permission of the commanding officer. Persons violating these conditions will have their invitations withdrawn, be removed from the installation, and are subject to prosecution.

Commercial vehicles may be authorized entry by permanent registration or visitor control methods. In addition to the normal administrative inspection procedures, additional precautions should be taken to prevent the introduction or removal of unauthorized material or personnel.

HONORING OF VEHICLE IDENTIFICATION

Since military, retired military personnel, and certain civil service employees will generally have

personal or official requirements to enter nearby military activities in their private automobiles, the honoring of DOD vehicle identification media issued by other activities is allowed, according to OPNAVINST 5560.10.

SPECIAL PRECAUTIONS

Personnel responsible for the accomplishment or implementation of personnel and vehicle control procedures should at all times be watchful for the unauthorized introduction to or removal from the installation of government property, especially weapons, ammunition, and explosive materials. This surveillance should encompass all personnel and means of transportation, including government, private, and commercial vehicles, aircraft, railcars, and ships.

INTRUSION DETECTION SYSTEMS

LEARNING OBJECTIVES: State the purpose of Intrusion Detection Systems (IDSs). Identify 6 advantages of IDSs and list 10 factors to consider when these systems are employed. Describe four types of IDSs.

Intrusion Detection Systems (IDSs) are an essential element of any in-depth physical security program. IDSs consist of sensors capable of detecting one or more types of phenomena, signal media, annunciators, and energy sources for signaling the entry or attempted entry into the area protected by the system. The design, implementation, and operation of the IDS should contribute to the overall physical security posture and the attainment of security objectives. IDSs are designed to detect, not prevent, actual or attempted penetrations. Therefore, IDSs are useless unless supported by near-real-time assessment systems and prompt security force response when the systems are activated.

The advantages of IDSs include the following:

- Permit more economical and efficient use of security personnel through the employment of mobile responding security forces instead of fixed guard posts and/or patrols
- Provide additional controls at critical areas or points
- Substitute for other physical security measures that cannot be used because of safety regulations, operational requirements, building layout, cost, or similar reasons

- Provide insurance against human error
- Enhance the security force capability to detect and defeat intruders
- Provide the earliest practical warning to security forces of any attempted penetration of protected areas

IDS EMPLOYMENT FACTORS

The following factors should be considered in determining the feasibility and necessity of installing IDS equipment:

- Mission
- Criticality
- Threat
- Geographic location of the installation or facility and location of facilities to be protected within each activity or installation
- Accessibility to intruders
- Availability of other forms of protection
- Life cycle cost of the system
- Construction of the building or facility
- Hours of operation
- Availability of a security force and expected response time to an alarm condition

TYPES OF INTRUSION DETECTION SYSTEMS

There are basically four types of IDSs: the local alarm; central station; police connection; and proprietary. Each of these systems will be discussed in turn.

Local Alarm

In the local alarm system, the protective circuits and alarm devices actuate a visible or audible signal in the immediate vicinity, usually on the exterior of the building. The alarm transmission/communication lines do not leave the building. Response is by local security forces that may be in the area when the alarm is sounded. Otherwise, the security force will only know of the alarm if it is reported by a passerby or found during routine checks. The disadvantage of this system is that intruders know exactly when the alarm is activated and

can easily elude capture. This system should be used only when guards can respond in a timely manner.

Central Station

In the central station system, the operation of alarm devices and electrical circuits are automatically signaled to, recorded in, maintained and supervised from a central station owned and managed by a commercial firm with guards and operators in attendance at all times. These personnel monitor the signals and provide the response force to any unauthorized entry into the protected area. Connection of alarm equipment to the central station is usually over leased telephone company lines. The provisions of paragraph 0809c in OPNAVINST 5530.14 apply.

Police Connection

In the police connection system, the alarm devices and electrical circuits are connected via leased telephone company lines to a monitoring unit located in nearby civilian police stations. An agreement with the local police department must be arranged before establishment of this type of system. The provisions of paragraph 0809c in OPNAVINST 5530.14 apply.

Proprietary

The proprietary IDS is the prescribed IDS for all naval activities and installations. This system is quite similar to a central station operation except that the IDS monitoring/recording equipment for all IDSs at the installation is located within a constantly manned security force communications center maintained and owned by the government installation. The installation security force responds to all IDS activations. Connection of the alarm sensor equipment to the security force central monitoring station is normally over leased telephone company lines or by separate cable owned and installed by the installation. If a computerized IDS is used, it must be safeguarded against tampering.

IDS EQUIPMENT DESCRIPTION

LEARNING OBJECTIVES: Explain exterior and interior sensors. Describe the following subsystems: data transmission and annunciator, control, and display. Explain the operating power requirements for IDSs.

Each intrusion detection system is comprised of various types of equipment that operate in unison to complete the overall detection function. In addition to

sensing devices installed at protected locations, data generated by the sensors should be transmitted by electrical impulse to control annunciator display equipment in a central alarm annunciating station. Electrical power should be supplied to all items including backup power. Each equipment category comprises a subsystem and is described in the following paragraphs.

SENSOR SUBSYSTEM

The sensor subsystem is divided into two areas, depending upon environmental use and application: exterior and interior.

Exterior Sensors

Exterior intrusion detection devices (sensors) should be selected for the best performance under prevailing local environmental conditions such as soil, topography, weather, and other factors that could adversely affect performance or increase false alarm (an alarm without a known cause) rates. Exterior IDSs should be an approved DOD standardized system, such as the Base Installation Security System (BISS), or commercial equipment approved by CNO (N09N)/CMC (POS-40), as appropriate, as an element of the DOD standardized system. Presently installed IDSs not meeting the standards of this instruction may continue to be used until replacement is necessary. Waivers or exceptions to use presently installed IDSs are not required.

Interior Sensors

Interior IDSs should be an approved DOD standardized system such as the Joint-Service Interior Intrusion Detection System (J-SIIDS), the AN/GSS-20, or commercial equipment approved by CNO (N09N)/CMC (POS-40), as appropriate, as an element of the DOD standardized system. Presently installed IDSs not meeting the standards of this instruction may continue to be used until replacement is necessary. Waivers or exceptions to use presently installed IDSs are not required.

DATA TRANSMISSION SUBSYSTEM

The data transmission subsystem links sensors with control and monitoring consoles. The transmission medium is used to send control signals and data to and from all sensors, control points and annunciator panels. It may be hardwired land lines, radio frequency links,

fiber optic cables, or a combination. This vital subsystem is the weakest and most vulnerable of the IDSs and requires protection.

ANNUNCIATOR, CONTROL, AND DISPLAY SUBSYSTEM

The annunciator, control, and display subsystem provides equipment for central operational control and monitoring of the IDSs. Through this equipment, security force personnel are instantly alerted to the status of any protected area. This subsystem should be located in a restricted area and closed off from public view. Alarmed spaces should be designated by zones.

OPERATING POWER REQUIREMENTS

The power to operate an IDS is usually 115-volt ac electrical power, available in each protected area and the security force headquarters except where safety requirements prohibit its use (hazardous storage areas, and so on).

The importance of ensuring that the IDSs will operate continuously cannot be overstated. Each IDS should have an emergency power source to ensure the system's continuous operation. Emergency backup power sources usually consist of rechargeable batteries, or an emergency generator, or both. Paragraph 0809i in OPNAVINST 5530.14 contains a detailed discussion on emergency power sources.

IDS POLICY

LEARNING OBJECTIVES: Explain IDS equipment procurement policy. Describe military construction (MILCON) and OPNAV/CMC designated sites. Explain the policy regarding emergency power, contractor qualifications, installation, and maintenance.

Only IDS standard equipment with formally evaluated capabilities should be used. No IDS should be procured that cannot be supported for the life-span of the equipment, usually 10 years. System design should consider the delay time of associated barriers, location of reaction forces, and the threat to the protected asset. Now let's consider MILCON IDSs AND IDSs for OPNAV/CMC sites.

MILCON IDSs

Facility IDSs that are installed under the MILCON program should be acquired by competitive procurement. Design guidance should be according to NAVFAC DM 13-02 for background and review and NAVFAC NFGS 16727 to match the requirements of the asset to be protected.

IDS FOR OPNAV/CMC-DESIGNATED SITES

Due to the size and complexity of an IDS, certain sites have been designated as OPNAV/CMC. These sites commonly involve both interior and exterior sensors subsystems, electro-46

optical alarm assessment subsystems for perimeter sensors, extensive data transmission networks, and central computers for security monitoring and control. Examples of these types of sites are those storing nuclear weapons, sensitive conventional ordnance, and critical readiness assets. Within the Marine Corps, IDS is centrally managed by CMC (POS-43).

Technical support for system integration, design, procurement, and installation is provided for both services by the Naval Electronics Systems Engineering Center (NAVELEXCEN), Charleston, South Carolina. Naval Electronics Systems Engineering Activity, St. Inigoes, Maryland, provides technical support for closed circuit television subsystems, thermal imagers, and other assessment devices.

Proprietary Type of IDS

All systems within the Navy and Marine Corps should be of the Proprietary type except when used in civilian communities or Reserve Centers. In these circumstances where there is no government force available, the system may be the Police Connection type or Central Station type. Telephone answering services should not be used. If the police connection type is used, formal arrangement should be made with the local police to ensure they monitor and respond to the system.

Emergency Power

An emergency backup (secondary) power source should be provided for operation of the IDSs. This secondary power source should be provided by an uninterrupted emergency generator, if available, or by batteries. Batteries should have adequate capacity to maintain proper operation of the system under normal operating conditions for a minimum of 4 consecutive

hours in the event of ac power failure. To calculate the size of batteries, 105 percent of the capacity necessary should be provided and it should be assumed that during the period of operation on backup power, 5 percent of the detection circuits will be in the alarm mode. If a computerized IDS is used, the computer must be provided with a continuous-type uninterruptible power supply (UPS).

Contractor Qualifications

The contractor used to install, service, and/or maintain intrusion detection equipment and/or security alarm systems should be listed by Underwriters Laboratories (UL) in a commercial burglar alarm category for the appropriate level of protection required by the facility and should be staffed and equipped to provide maintenance on the system on a 24-hour-per-day, 7-day-per-week basis with a response time of not more than 4 hours.

The UL requirement for contractors is listed in NAVFAC NFGS-16727. Verification of UL listings can be made by calling the Group Leader of the Burglary Protection and Signaling Department Certification Service. Phone numbers can be obtained from LEPS Teams located in Norfolk, Virginia, or San Diego, California.

INSTALLATION

The following installation procedures should be adhered to:

1. The preferred installation method for all UL-listed IDSs is through qualified personnel from the base public works office or a designated Navy field activity, such as NAVEXCEN Charleston.

2. Knowledge of the details of a specific IDS may afford an individual the means to effectively bypass the installation. Usually the original installation of an IDS is accomplished under a construction contract, and various elements are involved-the contract document, specifications, detailed drawings, and the actual physical labor necessary to install the device. Sensitive documents, such as the as-built drawings that show both specific design details and locations of components, should be considered for a security classification assigned by the command. Since most IDSs in current use are available on the open market, classification of the systems themselves is not appropriate. The general location of the system is not classified, although its presence should not be publicized. The contract document itself may reveal only sensor locations and

administrative specifications involved in the contract. However, to make sure an IDS is used to protect classified material, contractors should be chosen from those with a facility clearance and only cleared personnel used to install, inspect and maintain IDSs where access to classified interests is involved.

All as-built drawings and a sufficient quantity of maintenance, operator instructions, and engineering and schematic drawings should be provided to the security officer before installation, testing/acceptance.

MAINTENANCE

Proper maintenance of an IDS is imperative. Systems not properly maintained may fail to detect intrusion or yield a high number of false/nuisance alarms, thereby losing credibility and demoralizing the security force to the point where alarm activations may be often ignored. As a result, the level of security may be less than that obtained without an IDS. The more complex an IDS, the more highly skilled and trained the maintenance technicians must be. The number of technicians required to maintain an IDS depends upon the system's complexity and reliability. Vacations, sick leave, coverage of more than one malfunction at a time, and similar factors must also be considered. Maintenance can be provided by trained government personnel (military or civilian) or by contract. The contracting activity should develop procedures to ensure only cleared personnel inspect and maintain an IDS, when considered appropriate by the user activity.

IDS Testing Frequency

All IDSs will be tested at least monthly to make sure the systems are functional. In the conduct of these tests, all individual sensors should be tested to determine the continued adequacy of their intended application. All transmission devices should be validated to ensure proper operations. Testing should be conducted in concert with the security officer. Tests should include the temporary interruption of ac power to make sure ac/dc transfer can be made and batteries or other alternate power sources are functional. Test result records should be retained for 3 years or until the next Inspector General command inspection cycle, whichever is greater.

For perimeter (exterior) IDSs, randomly selected sections (zones) should be tested daily by causing an actual alarm. Depending on the type of sensor, such alarm activations could include touching the fence, walking/running over "protected" ground, or passing

through a sensor beam. The sections to be tested should be selected in such a manner that the entire perimeter IDS is tested at least monthly.

Scheduled preventive maintenance should be performed quarterly or more frequently if or when recommended by the equipment manufacturer.

Training

Maintenance training on Navy IDSs installed under OPNAV (N09N) programs is available at Service Schools Command, Great Lakes, Illinois.

Maintenance problems that result in an ineffective IDS are frequently caused by one or more of the following:

- Maintenance personnel not adequately trained or equipped (test equipment, tools, publications)
- System maintenance not assigned a sufficiently high priority
- Insufficient number of maintenance technicians
- Failure to perform routine preventive maintenance
- Lack of proper instructions and/or written procedures for security personnel responsible for operating and monitoring the system
- Failure to maintain a record on system tests, maintenance, false alarms, and similar elements for review of performance trends and potential problems

Supply Support

The availability of replacement parts will also directly affect the maintenance of IDSs. Navy IDSs (in contrast to commercial IDSs) will have supply support in place, commonly at the Ships Parts Control Center (SPCC), Mechanicsburg, Pennsylvania. Specific details on Navy IDS items and their support activity are contained in the Operational Logistic Support Summary (OLSS) given to each completed site.

Detailed information on commercial IDSs component selection and application; sensor/equipment descriptions and layouts; systems design; and installation, maintenance, and testing is contained in NAVFAC DM-13.02. General physical security equipment information is also described in the Naval Civil Engineering Laboratory (L56), Port Hueneme, California publication titled *Physical Security*

Equipment Manual. Information on the Navy IDS program and equipment can be obtained from NAVELEXCEN, Charleston, South Carolina. Information on the Marine Corps IDS program can be obtained from CMC (POS-40).

SUMMARY

In this chapter, we defined several physical security terms and outlined the composition of a security department. Security committees and command key

control procedures were also covered. Next, we looked at security inspections and perimeter and area protection and control. We also examined restricted and nonrestricted areas and the minimum security measures required for each area. Limited waterway areas were considered next, and we then looked at signs and posting of boundaries. Protective lighting was also covered, followed by physical security surveys and control of personnel and vehicles. Finally, we examined the types and characteristics of Intrusion Detection Systems (IDSs).

CHAPTER 11

MILITARY WORKING DOGS

As the requirements for physical security and law enforcement of stations and activities continue to increase, the available manpower will probably continue to be limited.

Military Working Dogs (MWDs), when properly trained, are intended to supplement and enhance the capabilities of security forces. When integrated into existing security forces, MWD teams enable those forces to perform their mission more effectively with significant savings in manpower, time, and money.

DUTIES AND RESPONSIBILITIES

LEARNING OBJECTIVES: Describe the management structure of the MWD program. Explain the composition of MWD teams, and describe the duties of the kennel master and MWD handler.

The U.S. Air Force is the single manager of the MWD program for the Department of Defense (DOD). Through the Air Force, the Chief of Naval Operations (CNO) has delegated the responsibility for the Navy-wide MWD program to the Special Assistant for Naval Investigative Matters and Security (CNO N09N), with organizational placement in the Headquarters of the Director, Naval Criminal Investigative Service (NAVCRIMINVSERV).

COMPOSITION OF MWD TEAMS

An MWD team is composed of one certified MWD handler with a properly identified NEC (MA-2005, MA-2006) and one MWD trained at the DOD Dog Center (341 Military Working Dog Training Squadron), Lackland AFB.

KENNEL MASTER

The kennel master (NEC MA-2006) exercises direct supervision over the unit MWD program and is directly responsible to the security officer for managing and operating the MWD section. The kennel master is a Chief Master-at-Arms (E7 or above) who should be a qualified detector-dog handler with a minimum of 3

years' experience, and a graduate of the MWD supervisor course of instruction at Lackland AFB. Activities having 1 to 14 MWD teams should have one kennel master assigned. Activities with 15 or more MWD teams should have two kennel masters assigned. At commands having one to four MWD teams, the Chief Master-at-Arms/Security Chief may act as the kennel master if he or she meets the requirements just described.

MWD HANDLER

Patrol/Detector Dog Handlers (NEC MA-2005) perform specialized duties in law enforcement, physical security, anti-terrorism operations, and detection of explosive and/or illicit drugs in the military community, using assigned MWDs. They are responsible for the care, welfare, and continuous training of assigned MWDs to make sure that physical conditioning and proficiency are maintained. They maintain the administrative records associated with the use and maintenance of assigned MWDs. Dog handlers must be a high school graduate or GED equivalent, with a minimum GCT/ARI (WR/ARI) of 100 (a minimum GCT of 45 is required). They must be a U.S. citizen eligible for access to classified information, have no history of mental disorders and no history of drug abuse (sales, possession or use), have had no record of conviction by a general, special, or summary court-martial and no conviction by non-judicial punishment or conviction by a civil court for any offense other than minor traffic violations. Qualified individuals must obligate 36 months of service within the acquired Navy classification upon completion of military working dog training.

TYPES OF MWD TEAMS

LEARNING OBJECTIVES: Describe the three types of MWD teams. Explain dual-qualification and single-purpose MWDs.

The Navy MWD program inventory consists of Patrol, Patrol/Drug, Patrol/Explosive, and Drug-Detector Dog (DDD) teams.

PATROL MWD TEAMS

Patrol MWD teams (Patrol, Patrol/Drug, Patrol/Explosive) used in normal law enforcement operations are a tremendous psychological deterrent to potential violators. MWD teams should be worked in all areas of the base. Further psychological benefit is derived by conducting periodic public demonstrations. MWD teams can be an integral part of a active crime prevention program.

PATROL/DRUG AND DRUG-DETECTOR DOG TEAMS

A very efficient means for detecting the possession or transportation of marijuana, heroin, cocaine, and related controlled substances is the well-trained patrol/drug or drug-detection team. These MWDs are trained to recognize the scent of controlled substances and to alert the handler, regardless of most efforts to mask or block the scents. Information on supposed means of confusing or restricting an MWD's effectiveness must not be made public.

PATROL/EXPLOSIVE AND EXPLOSIVE-DETECTOR DOG TEAMS

A very effective countermeasure to the increasing use of explosives is the deterrent and detection capabilities of the patrol/explosive MWD team. These teams are known by both military and civilian security and law enforcement forces as the best weapon presently available in the counter-terrorist arsenal. The most common use of these teams is for searching areas or buildings against which a bomb threat has been made. MWD teams are also useful in investigations involving most types of weapons, ammunitions, or explosives. Information indicating hidden materials in a general or specific place can be checked and verified quickly by using a MWD team.

DUAL QUALIFICATION/DUAL EMPLOYMENT

Patrol/Drug and Patrol/Explosive teams perform normal patrol duties when not required for detection work. If they are not assigned to a full range of duty positions, they will quickly lose their patrol proficiency.

SINGLE-PURPOSE MWDs

Drug-detector and explosive-detector MWDs are used mainly for their detection capabilities. These

MWDs may be trained in other areas (such as tracking, evidence search and recovery) to enhance their employment capability.

CERTIFICATION

LEARNING OBJECTIVES: Explain the importance of MWD certification. Identify the certification requirements for patrol MWD teams and detector MWD teams. Describe MWD team training.

Since apprehension of offenders is involved, there are several legal considerations when using MWD teams. MWDs are first certified after completing their training with the staff of the Military Working Dog Training Squadron of the U.S. Air Force. To meet legal requirements permitting their operational use, each MWD team must undergo validity certification when first assigned to duty and annually thereafter. Detector MWDs must undergo validity certification quarterly.

PATROL MWD TEAMS

Patrol MWD teams must maintain a proficiency level of 80 points to remain certified. The MWD is required to perform critical, semi-critical, and non-critical tasks. Each dog starts with 100 points. Each task is assigned a point value, which will be subtracted if that requirement is not accomplished by the MWD. A patrol MWD team is not necessarily required to certify in front of the commanding officer; however, it is highly recommended. Commanding officers should be given a realistic demonstration to fully understand the patrol MWD's capabilities. The patrol MWD must be moderately aggressive yet controllable, to pursue, attack, and hold an intruder only on command from the handler.

DETECTOR MWD TEAMS

Drug-detector dogs must maintain 90 percent accuracy on each odor the dog has been certified to detect. Proficiency tests will include at least 10 trials for each drug the dog is trained to detect, with a false response rate no higher than 4 percent.

Explosive-detector dogs must maintain 95 percent accuracy on each odor the dog has been certified to detect. Proficiency tests include at least 10 trials for each explosive the dog is trained to detect, with a false response rate no higher than 4 percent.

When a team is first assigned to a duty station, the commanding officer (who authorizes searches) should review the training records of the dog and witness a demonstration of the team's capabilities. After review of the records and after witnessing the demonstration, the commanding officer certifies the MWD team as reliable by signing the quarterly review sheet. After the first duty certification, recertification requirements are as follows:

- The initial certifying commanding officer should review the training and duty experience records quarterly and recertify the team. A demonstration is not required for quarterly recertification unless the records show a lessening of the team's reliability.
- When a new handler is assigned, the new team must be recertified before being assigned to operational duty. Recertification is required even though the commanding officer has already certified the MWD with another handler.
- When a dog team's proficiency training has been interrupted for 30 consecutive days or more for any reason, recertification is required.
- When detector dogs fail to maintain their required 90 or 95 percent proficiency for each of the required odors for a period of 30 days, they are considered decertified and must be recertified.
- When a new commanding officer is assigned, full recertification will be required.
- Any time the authorizing commanding officer has reason to doubt the team's reliability, full or partial recertification may be required.

MWD TEAM TRAINING

MWD teams require continual proficiency training to maintain their skills, since their normal day-to-day duties do not provide the necessary opportunities. Without frequent reward reinforcement for performing a task correctly, the dog would soon lose interest in performing the task. Likewise, without continual practice, the handler loses the ability to "recognize" the MWD's responses. Proficiency training also improves the team's performance capability.

Training exercises that closely resemble actual performance requirements are the best form of training. Stereotyped exercises lead to stereotyped results, with little training value. Exercise scenarios used over and over are easier for the kennel supervisor and handler, but it conditions the MWD to anticipate required

actions, and the MWD will soon begin acting without waiting for commands from the handler. If this is allowed to continue, serious control problems could result.

The kennel master (supervisor) determines the duty cycles, duty hours, and methods of using MWD teams to best support installation operations. In making these determinations, the kennel master should consider mandatory proficiency training requirements and the care of dogs, kennels, and equipment.

The prescribed duty cycle for proficiency training allows at least 2 hours a day–10 hours per week. Daily work schedules provide 2 hours for feeding, grooming, exercising, and maintenance of equipment and kennel facilities. A normal work day should consist of a minimum of 4 hours of actual work, 2 hours of proficiency training, and the remaining time for administration and kennel maintenance.

Proficiency training is conducted on-base and balanced to address each dog's capabilities. Any deficient or weak areas should be stressed during subsequent training periods until proficiency is regained.

MWDS ABOARD SHIP

LEARNING OBJECTIVES: Describe how MWDS are used aboard ship. List the additional measures required when MWDS are employed for long periods aboard ship. Explain the considerations for detection in shipboard spaces, and describe the hazards involved in movement to and from below-deck areas.

MWDS have been used as an effective deterrent to the introduction of illegal drugs aboard naval ships for several years. Use of MWDS aboard ship, however, presents special problems that require careful planning by the kennel master, MWD team, and commands using the services.

The mere physical presence of an MWD team presents a deterrence. This deterrent effect will remain as long as the handler makes sure that daily proficiency training is conducted in a controlled training environment. Even so, some individuals will attempt to introduce controlled substances onboard. If these individuals are successful, the deterrent and credibility effect that an MWD team may have will be diminished.

The MWD team should anticipate the probability of flying out to a ship by helicopter or other aircraft. Kennel masters or handler personnel should prepare their team and themselves in the same manner as they have introduced the MWDs to ships. Initial introduction should consist of entering and leaving the various types of aircraft when they are not operational. This should be followed by frequent walks near the flight line to expose the MWD to the noise and odors. (Make sure personnel in charge of flight lines and base operations have been briefed.) When possible, have the MWD team inside these various types of aircraft during turn-ups, taxi trips to the fuel farm, or during compass settings. Local short hops will also ensure that the MWD team will require very little adjustment time after a flight to a shipboard commitment.

LONG TERM USE OF MWD TEAMS ONBOARD SHIP

The use of MWD teams aboard ships and submarines for a long period will require additional measures as follows:

- When MWD teams are required to remain overnight or for extended periods, the security officer/CMAA is responsible to make sure that security is provided for the MWD team(s). At least one reliable senior petty officer, preferably an MA, will be assigned to the MWD team as long as they are on board. This senior petty officer should assist in providing for the safety and well-being of the MWD team.

- Berthing/kenneling arrangements should be provided. A stateroom is strongly recommended for security purposes. The Master-at-Arms force should make frequent checks of the area at varying times, but not less than at hourly intervals.

- Additional secure areas will be required to allow the MWD to exercise and to relieve itself. These areas should be secluded and security provided. The handler is responsible for cleaning up any stools or urine in this area.

The MWD team(s) visiting a ship must understand that they are professionals who are providing a service. Their conduct while on board should be in keeping with those standards.

CONSIDERATIONS FOR DETECTION IN SHIPBOARD SPACES

Although most spaces aboard ship are very confined and congested, the MWD team should be able to

complete an effective search if the MWD has been properly conditioned to this type of environment.

Berthing Areas

In berthing areas, the MWD will be required to clear very tight areas. The handler's presentation should be smooth and systematic to prevent false cuing of the MWD. The handler should also be more aware of the MWD's initial response and allow the MWD to have a little more freedom than usual. Handlers should remember that the ventilation system will be operational and the effects of air circulation will be apparent.

Storerooms

Storerooms are normally congested and cartons are stowed loosely unless the ship is underway. The handler should be very conscious of the safety risk for the MWD, but still perform an effective search. Do not expect the MWD to climb shifting stacks of cartons. The rapport that you have with the MWD could be ruined or the MWD could be injured by falling cartons.

Machinery, Engine and Fire Room Spaces

Handlers must remember that machinery spaces, engine, and fire rooms are not only a safety hazard to the MWD but also a health problem because of various types of fumes and heat. The MWD should be kept on just enough leash to work effectively. The MWD should be given frequent relief from the heat of these areas. A panting MWD cannot perform an effective search. However, this is not an excuse for not working these spaces.

Galleys/Sculleries

Galleys and sculleries should be inspected as routinely as any other space. Again, the handler should be aware of the health and safety hazards and the heat. Searches should be conducted during non-meal hours.

Movement below decks

Handlers should be aware of the many hazards involved in movement to and from below-deck areas. Some ladders are constructed in a manner that may cause MWDs to catch their toe nails, which could be pulled out. Other ladders are so steep that the MWD might refuse to negotiate them. Prior conditioning of the MWD should alleviate these problems.

MWD SEARCH TECHNIQUES

LEARNING OBJECTIVES: Explain the guidelines to be followed when MWD searches are conducted.

Although MWD utilization is coordinated independently at each command, it is imperative that all methods of team employment remain within the constraints imposed by military law. The local Staff Judge Advocate (SJA) can provide advice and updated guidelines pertaining to proper search and seizure. All searches should be conducted within these guidelines-without exception.

Searches should be conducted at the request of the commanding officer. All functions concerning the search (coordination, personnel assignment, duration, and so on) are the responsibility of the commanding officer or the Chief Master-at-Arms/Security Officer.

Commanding officers and other officials delegated the authority to grant command authority to search should observe the MWD team's effectiveness prior to a search as a basis for ordering a probable-cause search. This certification demonstration may be conducted in conjunction with, but prior to, a scheduled search or separately at a time and place acceptable to the command and the MWD team personnel. This validity certification should be recorded and a letter filed in the MWD's probable-cause folder.

RECOMMENDATIONS FOR SUCCESSFUL DDD SEARCHES

LEARNING OBJECTIVES: List and describe nine recommendations for successful DDD searches.

In order for DOD searches to be successful, they must be conducted properly. The following recommendations apply:

- For safety purposes, only those individuals trained to assist a working MWD team will be permitted to actively participate in training scenarios and operational evolutions. Command representatives who are present should be warned to stay clear of the MWD.
- The date, time, and location of the search should not be published. Requests by telephone or message are not recommended as the element of surprise maybe lost. Individual contact is always the best method.

- The minimum number of personnel, preferably only the commanding officer, executive officer, and the Chief Master-at-Arms/Security Officer, need to have prior knowledge of the search.

- On the day of the search, a minimum number of reliable petty officers should be selected, briefed, and detailed at each entrance and/or exit of the search area to provide security and prohibit entry while the MWD team is conducting the search. One individual, to act as a recorder, should be provided to accompany each team requested.

- During searches, all doors/hatches to areas to be searched should be unlocked and left closed. The areas to be searched should be cleared of all nonessential personnel prior to the arrival of the MWD team.

- All vents, fans, windows, and air conditioning units should be secured (unless prohibited by considerations of safety) prior to the arrival of the MWD team in order to permit maximum retention of scent.

- Photography should not be permitted during actual searches. Demonstrations may be arranged through the kennel master, senior handler, and local public affairs office, if requested.

- To avoid possible injury to the MWD team or command personnel, the handler should request that all routes to be used by the team be cleared of personnel.

- MWD handlers are available for testimony concerning their operations at any non-judicial, judicial, or administrative proceeding. Prior notice of at least 48 hours is required in order to maintain the schedule of operations.

DUTIES AND RESPONSIBILITIES OF CHIEF MASTER-AT-ARMS OR COMMAND REPRESENTATIVE

LEARNING OBJECTIVES: List and explain six duties or responsibilities of the Chief Master-at-Arms or command representative.

The Chief Master-at-Arms (CMAA) or command representative should do the following:

1. Maintain liaison and coordinate search efforts with the kennel master or senior handler for the scheduling of searches, results, feedback and so forth.
2. Make sure that a recorder for each MWD team is assigned and awaiting the team's arrival.

3. Prior to the MWD team's arrival, muster and brief selected senior petty officers to act as a security detail. The detail should do the following:

a. Clear all areas to be searched of all nonessential personnel.

b. Make sure that no one removes suitcases, seabags, parcels, or other items from the search area. Personnel who must get dressed before leaving should be observed while they dress, to prevent their hiding small parcels or contraband on their person.

c. Make sure that all search areas remain secured, permitting no one to enter until that area has been searched. If the DDD "responds" in that area it should remain secured until all "responses" have been searched and the CMAA/command representative opens the area.

4. Make sure that all vents, fans, windows, and air conditioning units are secured prior to the arrival of the MWD team unless prohibited by safety considerations.

5. Make sure that the areas to be searched are cleared of all toxic substances, paints, volatile substances, metal and wood shavings, broken glass, oil and grease spills, powdered substances, unsecured food, and other items that might distract or be hazardous or harmful to the MWD team.

6. Make sure that all "response" areas are searched. A search of the response area based upon a "consent search" or "command authorized search" should be conducted as soon as possible after the team has completed searching the space. If a significant quantity of drugs is found during the search (indicating sales), the local NCIS office should be notified immediately. Results of the searches will be forwarded, using search data sheets, to the base security officer responsible for the MWD team.

DUTIES AND RESPONSIBILITIES OF THE RECORDER

LEARNING OBJECTIVES: List and explain four duties of the recorder. List 12 specific items of information that should be included in the search report. List five items that should be included in the report about the field test used.

The recorder will be appointed by the CMAA or command representative and should do the following:

1. Assist the CMAA/command representative with his duties and responsibilities.

2. Accompany the MWD team and CMAA/command representative to each area to be searched.

3. If a "response" occurs, indicate the area with tape or gum label, marking the tap/label with the response number, date, time, location, and any other information pertinent to the search.

4. Maintain the MWD team search data, recording the data required in the previous paragraph. A rough copy of this data should be provided to the MWD team prior to their departure.

DATA SHEETS AND SEARCH RESULTS

DDD Team Search Data Sheets and DDD team search results should be maintained by the recorder. The command requesting the MWD teams should compile the information for the MWD team and forward the results to the security officer responsible for the MWD team within 7 days after the search. The following specific information should be provided:

1. Assignment Location. Command/Activity Name/Ship Name and hull number.

2. Commencement Time and Date. The time the search commenced, using military time and day/month/year.

3. Completion Date and Time. The time the search ended or stopped, using military time and day/month/year.

4. Handler Name and Rate. The handler's last name and rate/grade (provided by the DDD team).

5. MWD's Name and Tattoo Number. The MWD's name and tattoo number (provided by the DDD team).

6. Name and rate/grade of the CMAA/command representative.

7. Response Number. Enter the number of the responses; start on 1 for the first response and continue in sequential order (1, 2, 3, and so on) until the end of the search.

8. Time. The time the MWD responded, using military time.

9. Space Identification. The ship compartment number or building and room number where the response was made.

10. Location Where Found. The exact location where the contraband was found, which should be the same place the MWD responded.

11. Item Found. The type found (for example, homemade pipe, marijuana); abbreviations may be used (MJ-marijuana, CO-cocaine, and so forth). Indicate if confirmed by field or lab test.

12. Quantity. The quantity of the item found; in the case of marijuana or other drugs that must be weighed, use approximate weight.

FIELD TEST INFORMATION

The following field test data should be provided:

1. Brand. The brand name of the fieldtest used (for example, B & D for Beckin and Dickinson, other printout).

2. Result. The result of the field test, positive or negative only.

3. Lot #. The lot number from which the particular test came. This is usually found on the outside of the box.

4. Date and time of the test.

5. Name, rate, and SSN of person performing the test.

Make sure any substances found subsequent to the search are tested with a field test kit and by a laboratory. This is necessary to verify the proficiency of the MWD team. The Naval Investigative Service Regional Forensic Laboratory provides this service to all commands within their respective geographical region. Ensure that a proper chain of custody is maintained.

MWD OPERATIONAL SAFETY PROCEDURES

LEARNING OBJECTIVES: List and explain six safety precautions for MWD handlers.

Although handlers spend a great deal of training time learning to control their MWDs, no one can be sure the MWD will not break command and unexpectedly attack someone. When working MWDs, handlers must constantly be aware of and alert to the things going on around them. They must learn to recognize when the MWD is uneasy or becoming agitated and learn what events or conditions cause the MWD to react this way. The following is a list of some of the precautions handlers must observe at all times:

- When working the MWD in or around large numbers of people, keep the dog on a short leash.

- Do not allow people to pet the MWD.

- Keep MWDs on a leash except when released to attack or search a building. Before releasing an MWD, the handler **MUST** give a verbal warning to inform anyone that may be in the area to cease all movement.

- Never give up control of their MWD to anyone other than trained MWD handlers or veterinary personnel known to be qualified to competently handle that MWD.

- When handlers challenge an unknown person, approach a suspect, check a person's identification, or are involved in any situation that requires them to divert attention from control of the MWD, they should always inform the person or persons that the dog is an MWD, trained to attack.

- Never assume that a person knows the potential danger of the MWD.

POLICY ON RELEASING MWDs

LEARNING OBJECTIVES: State the policy on releasing an MWD, and explain the reason for this policy.

Because of the training the MWD has received, it must be considered a weapon; and many of the restrictions that apply to the use of firearms also apply to the release of the MWD against a suspect. Releasing the MWD or allowing it to bite while on-leash is not considered using deadly force, but, the handler should not release an MWD, or allow it to bite, until all other less forceful means have failed. While MWD bites are seldom fatal, they are usually very serious.

LOGISTICAL SUPPORT TO THE U.S. SECRET SERVICE (USSS)

LEARNING OBJECTIVES: Explain how MWD teams may be detailed to the USSS. Describe the policies regarding uniforms, transportation, and weapons.

When requested by the USSS, federal departments and agencies are directed to assist the USSS in performing its statutory protective duties.

Public Law 94-524 (Presidential Protection Assistance Act 1976, October 17, 1976 (18 U.S.C. 3056)) provides that the support to the Secret Service be

made on a reimbursable basis except when the Department of Defense provides temporary assistance directly related to protecting the President, Vice President, or other officer immediately in order of succession to the office of the president.

All DOD personnel assigned to assist the USSS are subject to overall supervision by USSS personnel for the duration of the assignment, and report directly to the special agent in charge of the operation to which the MWD team is assigned. The policies concerning uniform, transportation, and weapons requirements are as follows:

UNIFORMS

Unless otherwise directed by the USSS, the normal attire for MWD team support is a conservative business suit.

TRANSPORTATION

Transportation requirements and after action reports remain the same except that no travel claim should be submitted to the Military Working Dog Executive Agent (MWDEA) for reimbursement by the command providing the MWD team support. Per Public Law 94-524 above, commands must absorb the costs for support to the USSS.

WEAPON REQUIREMENTS

Sidearms are not authorized unless directed by the USSS. Weapons policy will be addressed in confirmation message by the WDEA.

REQUESTS FROM CIVILIAN LAW ENFORCEMENT AGENCIES FOR MWD SUPPORT

LEARNING OBJECTIVES: Explain MWD support for a civilian law-enforcement agency.

Requests for MWD support by civilian law-enforcement agencies (CLEAs) should be forwarded to the CNO-N642 via the chain of command in accordance with SECNAVINST 5820.7. Requests will be forwarded to the Under Secretary of the Navy for Manpower and Reserve Affairs for approval or to the Secretary of Defense, if required. SECNAVINST 5820.7 establishes DON policies and procedures for providing assistance to federal, state, and local civilian law enforcement officials. Civil authorities may be

advised of the availability of the resources through normal community channels. They will also be advised of the restrictions imposed on the use of these resources and the reimbursable requirements for these services.

REQUESTS FROM CIVILIAN LAW ENFORCEMENT AGENCIES FOR MWD SUPPORT OUTSIDE THE CONTINENTAL UNITED STATES

LEARNING OBJECTIVES: Explain MWD support for a civilian law-enforcement agency outside the continental United States.

Requests for MWD teams for use outside the continental United States (OCONUS) must be routed through the United States Embassy in the country where the assistance is requested to the responsible Commander-in-Chief (CinC). The Department of State (DOS) must be informed through embassy channels. The CinC must forward the request to the Chairman, Joint Chiefs of Staff (CJCS) for approval, by telephone if necessary. Requirements beyond the CinC's capability to accomplish must be referred to the CJCS. The CJCS must forward the request to Office of the DOD Coordinator for Drug Enforcement Policy and Support (OCDEP&S), who will then forward the requirements to the Military Working Dog Executive Agent (MWDEA) for action.

SERVICES NOT PROVIDED BY MWD TEAMS

LEARNING OBJECTIVES: List three services not provided by MWD teams.

The MWD teams sole function is to indicate on the basis of a trained MWD response, the suspected location of controlled substances. MWD teams WILL NOT provide

- laboratory testing services for suspected contraband,
- legal advice, or
- transportation to or from any command or other area for anyone other than authorized MWD team personnel.

MWD TEAM CONSIDERATIONS

LEARNING OBJECTIVES: Explain the policy regarding the MWD and the handler. Describe situations under which an MWD search may be terminated.

The MWD and handler must always be used together. Loaning an MWD to civil authorities for use with another handler is prohibited. The handler should have exclusive control over the search effort and complete access to the search area. Handlers perform the sole task of working the MWDs and should not take part in any other activities to help civil authorities unless specifically authorized. Detector dogs may not be used to search persons. MWD teams should not be posted at any post, quarterdeck on piers, at the foot of brows, at gates, and so on, for the sole purpose of deterrence or “show.”

The MWD team kennel master/supervisor or handler, with permission of the security officer, may cancel or reschedule a search at any time due to the non-availability of teams or for higher priority commitments, and should notify the affected command as far in advance as possible.

The MWD team kennel master/supervisor of the handler is authorized to terminate any search for reasons of misconduct, non-compliance with requirements of

OPNAVINST 5585.2, or hazardous situations. Within 2 working days of the scheduled search, the kennel supervisor should forward a letter of cancellation to the command, via the chain of command, explaining the reasons for termination of the search. Continually reported and uncorrected problems may be cause for not servicing a command. For more information on the MWD program, see the *Military Working Dog Manual*, OPNAVINST 5585.2.

SUMMARY

In this chapter, we described the organization and management structure of the MWD program. The three types of MWD teams were covered, as well as the importance of MWD certification and training. Use of MWDs aboard ship was discussed, followed by search techniques and recommendations for successful DDD searches. Next, we pointed out the duties of the Chief Master-at-Arms or command representative, and then we considered the duties of the recorder. Safety precautions for MWD handlers were covered along with the policy on releasing MWDs. Then we pointed out how MWDs may be detailed to the U.S. Secret Service, and how MWD support may be provided to civilian law-enforcement agencies both inside and outside the continental United States. Next, we discussed services NOT provided by MWD teams, and finally, we looked at some overall MWD team considerations.

CHAPTER 12

PATROLS

Naval security departments and detachments provide the commanding officer with continuous support by enforcing military laws, rules, and regulations. Security personnel are charged specifically with preventing and suppressing crime, assessing command physical security posture, investigating alleged offenses, apprehending offenders, and registering and controlling privately owned vehicles and weapons aboard the activity. Other responsibilities include keeping the commanding officer advised on the current state of crime and other potential problem areas, and procedures for preventing disruption of command discipline.

PATROL ACTIVITIES

LEARNING OBJECTIVES: Describe the four basic categories of patrol activity.

An effective, aggressive patrol operation is the cornerstone to the efficiency of any law enforcement tasking, whether military or civilian. The activities of patrol are as varied as the missions to be accomplished.

With few exceptions, patrol is performed by uniformed law enforcement personnel assigned to marked patrol units, or foot patrol. The primary emphasis of the uniformed patrol has been to establish a means of preventing and deterring crime, responding quickly to calls for service, and providing timely responses to non-crime service demands. Generally speaking, patrol activity can be broken into four basic categories:

1. Calls for service
2. Routine preventive patrol
3. Patrolman-initiated activity
4. Administrative tasks

These patrol activities comprise the basis for meeting the objectives of the patrol which are to (1) protect life and property; (2) prevent crime; (3) identify and apprehend offenders; and (4) maintain good order and discipline. Patrol operations have traditionally been designed to provide a multitude of both crime and

non-crime related services. The objectives of patrol reflect this multiplicity of purpose.

PATROL ORGANIZATION

LEARNING OBJECTIVES: List and explain the duties and responsibilities of the various members of the patrol organization.

Navy activities with a combined military and civilian population of 500 or more (or less, if deemed necessary by the commanding officer) have a security department with a security officer as the department head. Some larger commands will have a security detachment organized with a security officer as the Officer in Charge (OIC). The detachments and departments have at least three divisions: operations, administration, and investigations. Patrol comes under the functions of the operations division and the operations officer. The size of the station and the scope of security responsibilities determine the number of personnel assigned to a patrol section. Figure 12-1 is an example of a well staffed patrol organization. If a security department services a small activity, or is

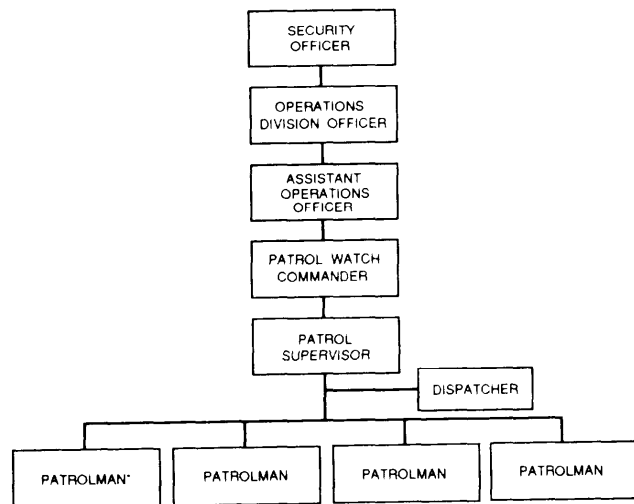

* Watch Section Field Training Officer (FTO)

Figure 12-1.—Patrol organization.

understaffed, adjustments to the organization must be made. For example, the Patrol Watch Commander may absorb the duties of the Patrol Supervisor, or eliminate the Assistant Operations Officer, or both. The duties of the patrol division are listed in the following paragraphs.

SECURITY OFFICER

The security officer is responsible for organizing, training, and directing the command's police and guard forces sufficient to protect, react to, and confront situations and circumstances which threaten personnel and property.

OPERATIONS DIVISION OFFICER

The operations division officer is appointed by, and is responsible to, the security officer for the following:

1. Overall performance of the patrol division.
2. Training and welfare of all assigned personnel.
3. Enforcing all applicable laws, rules, and regulations.
4. Maintaining all required records, reports, and files.
5. Assigning qualified personnel to guard and patrol duties and maintaining a record of such assignments.
6. Maintaining various statistics and interpreting data to keep the security officer informed on the status of the patrol division.
7. Reviewing daily all incident complaint reports and preparing a brief of significant events (usually from the security desk journal) for the security officer.

In addition, the operations division officer may prepare and keep an up to date map of the entire area covered by the patrol division. This map can show the routes covered by each patrol, off limits areas, and other areas of significance. A bulletin board may be used for posting special orders for each patrol, photographs and descriptions of wanted persons, and other items of interest to the patrols.

PATROL WATCH COMMANDER

The patrol watch commander is under the direct supervision of the operations division officer or assistant operations officer, if assigned. The patrol watch commander is responsible for law enforcement and security of the activity during the period of the

watch. The duties and responsibilities of the patrol watch commander are as follows:

1. Ensuring that the patrol duty section personnel maintain a smart and correct military appearance at all times.
2. Instructing members of the watch of their duties and responsibilities and ensuring that all assigned tasks are **carried out in a professional manner**.
3. Ensuring that all trainees are assigned to the watch section field training officer (FTO) for proper indoctrination and training.
4. Ensuring the safeguarding of persons placed in detention. The watch supervisor (or turnkey if assigned) ensures that, when a person is searched, all applicable instructions pertaining to searches are complied with and that booking and required log entries are made.
5. Reviewing all incident complaint reports ensuring they are complete and concise and submitted to required authorities in a timely manner.
6. Making frequent inspections of persons apprehended, ensuring that no unnecessary bodily contact is made.
7. Making frequent inspections of the security department headquarters.
8. Responsible during the watch period for all equipment and items under the custody and control of the patrol section, such as weapons and patrol vehicles.

PATROL SUPERVISOR

The patrol supervisor is under the direct supervision of the patrol watch commander. The duties and responsibilities of the patrol supervisor are as follows:

1. Ensuring that all patrol personnel are assigned to a patrol area and that they understand their duties and responsibilities.
2. Ensuring that patrol personnel remain in their assigned patrol areas.
3. Being aware of all applicable departmental instructions, procedures, and policies that affect the proper performance of duty.
4. Ensuring the safe and proper operation of all assigned patrol vehicles.
5. Acting as a roving patrol, particularly in places or areas frequented by large numbers of personnel or trouble spots.

Patrol supervisors assist patrol personnel in handling serious incidents. Supervision of patrols ensures uniform performance of duties in accordance with approved procedures and promotes exemplary appearance and conduct. The patrol supervisor should correct any improper actions of patrol personnel and continually seek to improve policies and procedures with recommendations from field observations.

Supervisors are held responsible for the accuracy, grammar and format of reports submitted by their assigned personnel. Good reports can aid in reducing the administrative burden on higher level supervisory personnel, resulting in cost reductions.

The various forms, logs, and records used by patrol personnel are discussed in chapter 18.

DISPATCHER

The dispatcher is directly responsible to the watch supervisor or, in his or her absence, the patrol supervisor. The duties and responsibilities of the dispatcher are as follows:

1. Monitoring and directing the activities of the patrol units according to the direction of the watch supervisor.
2. Monitoring police radio nets and alarm indicators, ensuring expeditious response of field units.
3. Serving as an information source for patrol units. However, no supervisory functions are performed.
4. Maintaining the desk journal which is the official record of all patrol radio traffic. It is filed chronologically by date and serves as a backup reference and support for other reports.

It is imperative that the radio log contains the source, time, and substance of conversation on all routine calls. In cases of serious incidents, an incident complaint report (ICR) will be completed.

PATROLMEN

The patrolmen are directly responsible to the patrol supervisor. The duties and responsibilities of the patrolmen are as follows:

1. Patrolling an assigned area, ensuring security is maintained in the zone or area to which assigned.
2. Remaining vigilant at all times and ensuring his or her actions are in keeping with departmental procedures and policies.

3. Responding to radio calls and engaging in self-initiated law enforcement activities.

4. Extending military courtesies and making quick decisions based on judgment and common sense.

WATCH SECTION FIELD TRAINING OFFICER

The watch section field training officer (FTO) is directly responsible to the patrol watch commander for training purposes. Unless a patrol unit is adequately manned to provide a person to act solely as the FTO, the most qualified patrolman in the section will act in that capacity.

The duties and responsibilities of the field training officer are as follows:

1. Ensuring that each trainee receives extensive training in accordance with departmental procedures and policies.
2. Keeping abreast of all new and updated changes.
3. Ensuring that each trainee is knowledgeable of personal appearance standards and military courtesies.

METHODS OF PATROL

LEARNING OBJECTIVES: Describe six techniques helpful in performing foot patrol duty. Explain the methods and techniques used in motor patrol, and the list the four purposes of fixed post patrol.

Patrols normally consist of two patrolmen who enforce activities in an assigned area during a specified period of time. The area of operations for each patrol and the duties to be performed are posted at the security headquarters and are distributed when the patrol is briefed. The detailed pattern and time of patrolling should be varied so that would-be offenders cannot determine routes and schedules. Patrols may be either mobile (foot patrols and motor patrols) or fixed posts.

In order to get assistance in cases of emergency, you must be familiar with the means of communication available on particular routes, posts, and with neighboring or overlapping patrols. Now let us discuss the different types of patrols.

FOOT PATROLS

Foot patrols cover limited areas frequented by military personnel, such as high traffic areas or amusement areas. Short patrol routes may be used so that special attention to known or potential trouble spots may be provided. The following techniques are helpful in performing foot patrol duty:

1. Know your patrol area thoroughly, including its streets, buildings, and other physical features.

2. Become acquainted with persons who live or work in your area. They may be good sources of information or assistance. Be courteous toward them but do not accept favors or gratuities from them.

3. Be able to give simple, accurate directions as to the location of certain facilities, in or adjacent to your area, such as bus stops, hospitals, and recreations areas. Know emergency/alternate routes in and from your area.

4. Patrolman should walk at a distance from buildings or structures so that they can better observe the area be less susceptible to surprise, and be readily seen and contacted by supervisors or by persons who seek assistance.

5. When patrolling off base and authorized to enter public buildings, do so in an inconspicuous manner. Pause to observe the activities and then move through the establishment to view conditions without loitering or disturbing the occupants. When entering dark areas, such as unlighted alleys or interiors, let your eyes become adjusted to the darkness before you proceed further. When using a flashlight, hold the light in your non-weapon hand and at a distance to the side of your body. This will aid in keeping the light from making you a target.

6. Be curious, take initiative, check or inquire into anything within the scope of your duties and authority concerning military personnel that is suggestive of improper conduct or disorder, and take appropriate action.

MOTOR PATROLS

Motor patrols perform essentially the same functions as foot patrols; however, they provide coverage of a much more extensive area. This includes performing physical security checks of installation perimeters, gates, and other physical barriers throughout the command. Motor patrols are capable of providing rapid reinforcement of other patrols, supervisory or

transportation services, communication services, and emergency services.

Motor patrols normally divide their actions between cruising and parking in areas where violations frequently occur. These activities should be performed in a plainly visible manner since visible patrols encourage compliance. Parking the vehicle in obscure places, such as behind billboards or among trees, is not conducive to good public relations or effective enforcement.

Set a good example for other drivers by observing traffic regulations and road courtesy.

In answering emergency calls, warning devices, such as sirens and warning lights mounted on the vehicle, should be used in accordance with local standard operating procedures (SOPs). Speed limits apply to all vehicles on emergency calls, and are established as maximum SAFE speeds under ideal conditions. Excess speed should be resorted to only when local policy permits and the situation warrants such action.

FIXED POSTS

In many instances, patrol operations may require the establishment of fixed posts. Some of the purposes of fixed posts are the following:

1. Maintain visitor and vehicle control
2. Provide information and assistance
3. Provide control/surveillance at special events
4. Provide traffic control at dangerous inter-sections

COMMUNITY/HUMAN RELATIONS

LEARNING OBJECTIVES: List and describe seven rules that govern conduct, and explain 11 procedures that contribute to the overall community relations program.

The Master-at-Arms should make every effort to earn respect by performing duties in an efficient and courteous manner. Careful attention to your bearing and conduct will enable you to perform your duties more effectively. Regardless of any provocation, never be gruff or sarcastic.

RULES OF CONDUCT

Your every act while on duty as well as off duty influences the attitude that is developed toward you and what you represent. You must convey an impression of competence by the way you perform your duties. Otherwise, you cannot command respect or confidence, nor can you obtain the necessary prompt and proper compliance with your directions. You must, or course, be firm at times, but avoid unwarranted conduct and remarks that engender irritation and antagonism. Observe the following specific conduct rules while performing your duties:

1. Be alert, orderly, and courteous.
2. Be friendly and tactful.
3. Be sufficiently disciplined to control temper.
4. Display pride and interest in your duties.
5. Give assistance and information in a cheerful and willing manner.
6. Treat all persons fairly and impartially.
7. Be firm without being officious or overbearing.

COMMUNITY RELATIONS PROCEDURES

As an MA, your personal appearance and conduct must be exemplary. You must avoid actions and attitudes that could be detrimental to community relations. Through your actions, you must create an impression of professional competence and service in the community.

When you are performing duty on a naval base, you must remember that you are a representative of the naval service and constantly in public view. As such, you must maintain a reputation for smartness, alertness, and efficiency. Equipment and vehicles must be kept clean and in good repair.

Service personnel are quick to notice and criticize faults in the uniform and behavior of patrol personnel. The following procedures will contribute to the overall community relations program.

Do not smoke while in public view.

Limit conversations with the public. Many civil police agencies limit informal conversations to 3 minutes or less.

Do not loiter or lean against buildings or objects.

Learn the proper methods for handling incidents and spectators at the scene of incidents. This is an

effective method of gaining community confidence and goodwill.

Do not appear to the community to be “punishing” violators. Remember, this is the job of the courts, not the Master-at-Arms.

When driving police vehicles, use restraint and caution in emergencies, and drive slowly while on routine patrol.

Be courteous and professional when talking either in person or on the telephone.

The proper use of a notebook lends an air of professionalism to the Master-at-Arms and should be required by all patrolmen.

The use of security credentials to solicit favors, gifts, or gratuities is strictly forbidden. Furthermore, these concessions should not be accepted when offered. Members of the patrol must pay regular prices for meals, services, and goods, whether on duty or in a liberty or leave status.

Patrol members are forbidden to indulge in any form of intoxicating beverage or other form of intoxicant while on duty or at any other time, as prescribed by unit regulations.

Maintain respectful and friendly relations with civil authorities and the civilian community in general. Be alert to your duty in preventing disharmony prejudicial to the armed services.

COMMUNICATIONS

LEARNING OBJECTIVES: State the primary means of communication in patrol activities. Distinguish between a base station and a mobile two-way radio set. Describe transmission procedures in terms of net organization, standard 10-codes, and plain language communications. Identify four transmission techniques prohibited by the FCC. List six communications elements for which the patrol watch commander is responsible.

Radio is the primary means of communications used in controlling patrol activities. Most operations consist of a base station (police headquarters) and a number of mobile units. Most of the radios in naval patrol units are frequency modulated (FM) voice sets. Only voice communications can give the quick transmission response necessary for command control

of highly mobile patrols. Another important reason for the use of voice FM radio is the comparative ease of training personnel in using the equipment.

BASE STATION

A base station consists of a fixed or transportable radio transmitter and receiver capable of sending and receiving voice messages to and from other radios on the same net. Fixed base stations are normally installed permanently at police headquarters. Transportable sets are small, self contained units that can be operated on internal batteries or a 110-volt power source.

MOBILE TWO-WAY RADIO SETS

Mobile two-way radio sets consist of a radio transmitter for sending messages and a radio receiver for receiving them. Installed as an operating unit in a motor vehicle, a set provides two-way voice communication with the base central station and all other stations in the net. The sets are used in law enforcement and protection functions of the patrol unit. The sets enable each patrol to keep in constant touch with patrol headquarters and with other patrols of the unit. They provide direct communication with other patrol vehicles when investigating crimes and reporting traffic and other public safety conditions. The set can be used to request immediate assistance in an emergency.

Since a two-way radio communication system consists of a base station and one or more mobile units, or patrol vehicles in the patrol net, all sets in the net must operate on the same frequently.

TRANSMISSION PROCEDURES

Certain operational and procedural practices facilitate transmission and reception of messages. Personnel using radio communication equipment must know these operating practices.

Net Organization

Radiotelephone is the transmitting medium most frequently employed in patrol operations. In these operations, all stations comprising a net transmit and receive on the same operating frequency. A minimum of two stations is necessary to form a radio net. In a net of three or more stations, one is designated net control station (NCS). The NCS is sometimes referred to as the base station, central station, or fixed station. In patrol operations, the NCS is usually located at headquarters. The primary function of the NCS is to control patrols. It

also maintains circuit discipline and ensures that subordinate stations conduct operations in accordance with prescribed operating procedures.

Call Signs

Each radio station is assigned a call consisting of a combination of letters and/or numbers, to identify units without disclosing names or locations. They are used when any station in the net desires to contact any other station in the net.

Standard 10-Code Communication

Security departments must have radio communication practices that are standard from base to base. Personnel transferring within the security field should not be required to learn a new radio code with each transfer. During emergencies and crisis management situations absolute clarity of communications is mandatory. You should use the standard 10-code, standard response codes, and the phonetic alphabet (fig. 12-2) when transmitting.

Plain Language Communication

Plain language means the use of short statements to contact units, give assignments, describe situations, give locations, and provide specific instructions and warnings. Some examples of plain language transmissions by a dispatcher are as follows:

“UNIT SIX, SEE THE MANAGER, A FIGHT, NAS ENLISTED CLUB”

“UNITS TWO AND FOUR, REPORT OF A WOMAN SCREAMING, ROOM TWO THREE FOUR, BARRACKS EIGHT. UNIT TWO YOUR CALL IS CODE THREE.”

“UNITS ONE AND THREE, SILENT ALARM AT THE CREDIT UNION, CODE TWO.”

“UNIT SEVEN, SEE THE WOMAN REPORTING A PROWLER, QUARTERS ONE THREE FOUR ALFA, CODE TWO.”

“ALL UNITS RESPONDING TO SILENT ALARM AT THE DISBURSING OFFICE, CODE FOUR, FALSE ALARM, CONTINUE PATROL.”

FEDERAL COMMUNICATIONS COMMISSION (FCC)

The FCC was created by the Communications Act of 1934 as an independent agency to regulate interstate

<u>10-Code</u>			
10-4	Acknowledge		
10-6	Busy on assignment		
10-7	Out of service		
10-8	In service		
10-9	Repeat		
10-15	Prisoner in custody		
10-19	Return to station		
10-20	What is your location		
10-28	Registration or drivers license check		
10-29	Check for wanted		
10-38	Traffic stop		
999	Officer needs help — EMERGENCY		
<u>Response Codes</u>			
CODE 1	Routine response		
CODE 2	Urgent response without siren and lights		
CODE 3	Emergency response with sirens and lights		
CODE 4	No further assistance required		
<u>Phonetic Alphabet</u>			
A	Alfa	N	November
B	Bravo	O	Oscar
C	Charlie	P	Papa
D	Delta	Q	Quebec
E	Echo	R	Romeo
F	Foxtrot	S	Sierra
G	Golf	T	Tango
H	Hotel	U	Uniform
I	India	V	Victor
J	Juliett	W	Whiskey
K	Kilo	X	X-Ray
L	Lima	Y	Yankee
M	Mike	Z	Zulu

Figure 12-2.-10-Code, Response Codes, and Phonetic Alphabet.

and foreign commerce in communications by wire and radio. Military radio transmissions are subject to monitoring by the FCC. Supervisors and patrol personnel whose duties require them to operate radio equipment should be acquainted with practices prohibited by the FCC. In carrying out its responsibilities, the FCC specifically prohibits

1. use of profane or obscene language over the air;
2. transmission of superfluous, false, or deceptive signals or communication;
3. transmission not in accordance with the limitations of a station license or by an unlicensed station; and
4. transmission by unauthorized operators.

The patrol watch commander must monitor and inspect all communications systems while on duty to ensure

1. compliance with orders and prescribed doctrine or policy;
2. adherence to FCC regulations;
3. efficiency of operations in the accomplishment of assigned mission;
4. use of correct phraseology and radio procedures;
5. proper maintenance of radio logs; and
6. that all radio equipment is in operating condition and that repairs are made by qualified personnel only.

TRAFFIC STOPS (UNKNOWN RISKS)

LEARNING OBJECTIVES: Describe the procedures and techniques used to make traffic stops with unknown risks.

The safety of the Master-At-Arms/security force member and the people in the vehicle is the primary concern in any traffic stop.

Police officers make hundreds of vehicle traffic stops each day in the United States, many without incident, others at the risk of their lives. Over-confidence, carelessness, and lack of training are the main reasons officers lose their lives during vehicle traffic stops.

Before initiating the stop, select a safe location; If possible, choose a place large enough for the security vehicle and the violator to pull off the road and not

interfere with other traffic. During hours of darkness, lighting should play a major role in your selection of an area to stop a vehicle. Also, avoid

1. intersections,
2. curves,
3. hills, and
4. areas of total darkness.

Before making the stop, write down the license number of the vehicle, make, model, color, and if known, the year.

Notify the dispatcher BEFORE the stop is initiated, with the following information:

1. Location of stop.
2. License number of the vehicle.
3. Number of individuals in the vehicle and of what sex.
4. Reason stop is being made.

Initiate the stop, using emergency lights, horn, siren, and/or public address system, in that order. Direct the vehicle to the right edge of the roadway. Park the security vehicle 10 to 12 feet from the stopped vehicle and offset 3 feet to the left.



193.153



193.154

Leave emergency lights and four way flashers on and exit the vehicle to start your approach. Remember to look for traffic and vehicles pulling up behind you. Exit your vehicle completely and begin walking slowly towards the stopped vehicle. While approaching the violator vehicle, be observant for any unusual movement in the vehicle and any objects being thrown from the vehicle.



193.155

If only the front seat of the vehicle is occupied, keep the occupants in sight, approach from the left side of the vehicle, stop at rear window and check the back seat and floor and at the same time, press down on the trunk, to make sure it's closed and locked.

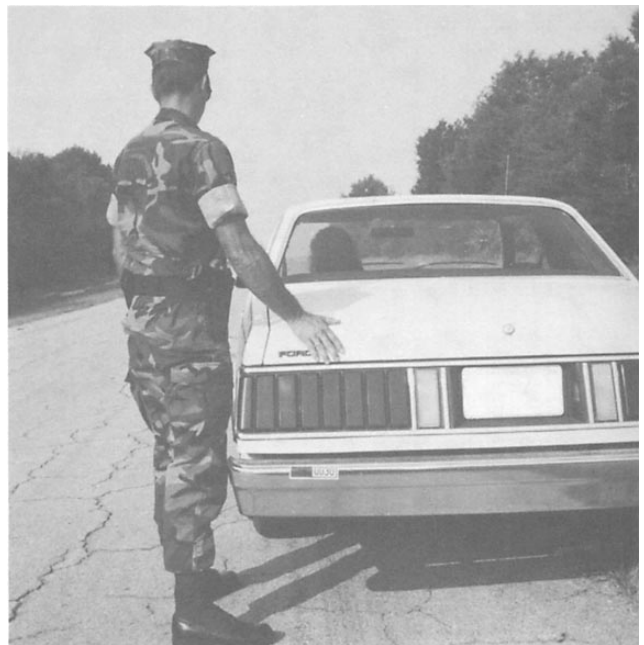

193.156

Stop at the rear edge of the driver's door and stand with your weapon side away from the driver. Using one knee, press it lightly against the door; this will alert and enable you to react if the driver attempts to exit the vehicle.

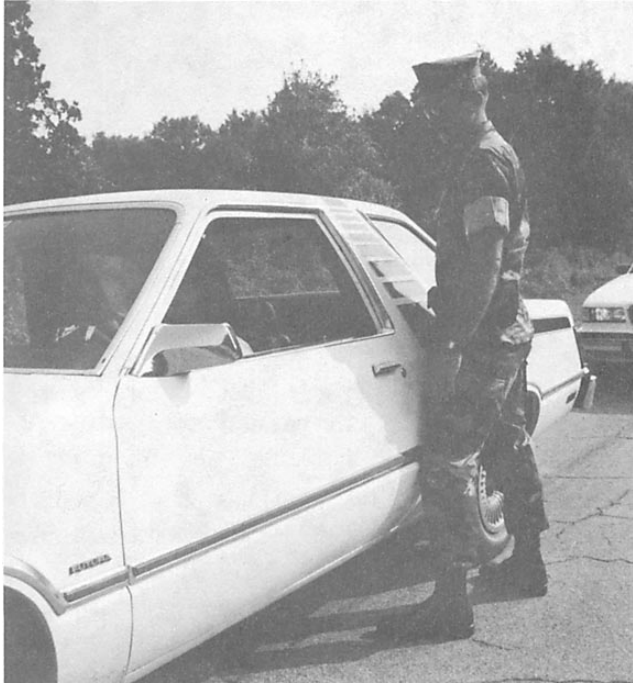

193.157

When the vehicle is occupied both front and rear seats, follow the same steps for approaching a vehicle with only the front seat occupied. Using peripheral vision, watch people in both the front and back seats.

If two Master-At-Arms/security force members are riding in one vehicle, they should not approach the violator vehicle together. Allow the driver to approach first and then the second member should approach on the right side of the vehicle and stop at the right rear section of the vehicle. An alternate approach is for the second member to remain at the vehicle, behind the passenger side door.

When there is cause to have the violator get out of his/her vehicle (such as a DUI), check for oncoming traffic for safety of all involved. If there is more than one person in the vehicle for suspected DUI, wait until backup arrives before removing the violator.

Open the driver's door, moving backwards carefully as the door opens, to avoid being struck by the door. If traffic conditions make it unsafe to exit from the driver's side door, use the door on the passenger side.

Once the driver is out of the vehicle, tell and/or escort the individual to the rear of his vehicle. Stay behind the individual, always alert for sudden movements or actions, and follow this person to the curb or sidewalk.

When stopping a motorcycle, direct the driver to step over to the curb or sidewalk.

When dealing with traffic violators, maintain courtesy and proper military and professional bearing. Except for unusual circumstances, keep all persons in the vehicle for better control.

Use proper titles. The security member/MA should introduce himself/herself (such as "Good morning Sir" or "Ma'am", "My Name is MA1 Boate or Patrolman Boate of NAS Neversail Security Department.")

Ask for identification documents, vehicle documents and other documents required by installation regulations or SOP. Accept only the requested items and not entire wallets or purses.

MA/security force members should never reach into the violator's vehicle. If issuing a traffic citation, write the citation inside your patrol vehicle, or at the right rear of the patrol vehicle, looking periodically at the violator vehicle.

After writing the traffic citation, use caution approaching the violator vehicle. After the driver signs the citation, ensure you have returned all documentation received, back to the driver.

Upon returning to your patrol vehicle, never turn your back to the violator vehicle; walk backwards to your patrol vehicle, using caution and care. If traffic is heavy or congested, assist the violator back into the traffic pattern/flow.



193.158

Unknown risk traffic stops are just that-unknown. The MA/Security member has no way to determine who is being stopped or how they may react. Be alert, cautious, and remember your training-the best way to be prepared. Don't become careless or relaxed just because you patrol a Naval installation and nothing unusual ever happens; you could be signing your death warrant.

TRAFFIC STOPS (HIGH RISK)

LEARNING OBJECTIVES: Describe the procedures and techniques used to make traffic stops with high risk.

High risk traffic stops (felony) are extremely dangerous and carry a greater possibility of risk for MA/security force personnel. Unlike the unknown-risk traffic stop, there is a definite known danger in stopping this violator/vehicle. The vehicle may have been identified as stolen, and the individuals in the vehicle may be suspected for serious offenses (such as rape, robbery, murder) or for whatever reason do not want to be stopped by any type of police officer. Due to the hazards and danger involved, the techniques for high risk stops are totally different.

Before the initial stop is made on a suspected vehicle, select a safe location, choosing a place large enough for two patrol vehicles side-by-side. The stop location should be well lighted if possible. Avoid intersections, curves, hills, and well traveled areas (both by traffic and pedestrians).

Stop the suspect vehicle; notify the dispatcher of location, make model, year, (if known), license number, number of individuals, and their sex, in the vehicle. Request additional backup; for every individual in the suspect vehicle, one MA/Security force member should be dispatched, and always add one additional. (In the event you do not see all individuals)

Stop your vehicle 30 to 40 feet to the rear of the suspect vehicle. Park directly behind the vehicle, not offset. Your engine should remain running in the event you must get out of range or back away from the suspect vehicle. At nighttime, you should keep your vehicle headlights, spotlights, and takedown lights focused on the suspect vehicle.

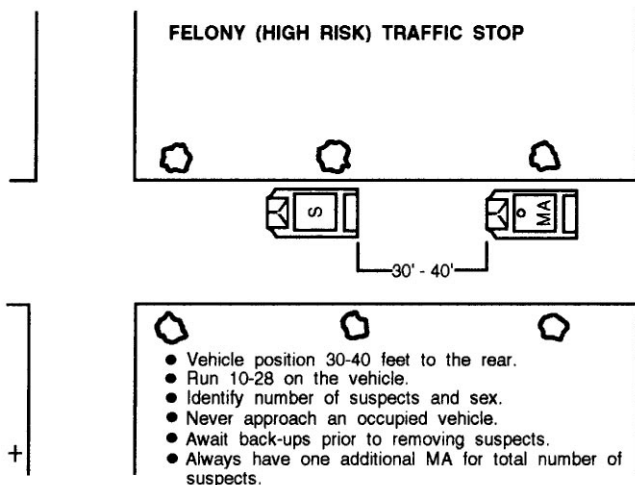

193.159

Using your public address system and in a clear, concise, firm, and authoritarian voice, instruct the occupants to remain in the vehicle and to turn off the vehicle engine. All commands should be brief and to the point. Do not accept delay. A sample command could be "DRIVER, PLACE YOUR HANDS ON THE FRONT WINDSHIELD, DO IT NOW!" The first MA/security force member at the scene will be the senior person and will do all the talking and issue all instructions. No one else should give commands; this will eliminate confusion.

While awaiting backup, remain in your vehicle (NEVER APPROACH A SUSPECT VEHICLE IN A HIGH RISK TRAFFIC STOP). Open your driver's side door, lean out slightly, and train your weapon on the suspect vehicle. Use your vehicle for maximum cover. Take notice of traffic before opening the door and, if it is dark wait until backup arrives to train on the suspect vehicle. Continually stay in communication with dispatcher.



193.160

Initial backup vehicle will park parallel to the first vehicle with room between the vehicles to open the second unit's passenger side door. The backup MA will move to the passenger side of the vehicle and train on the suspect vehicle. The occupants will be ordered to place their hands on the front windshield and keep them there. If the responding units are two-person patrols, then all MAs will remain in the vehicles and train on the suspect vehicle. No one should exit the patrol vehicles until required to secured the suspects.

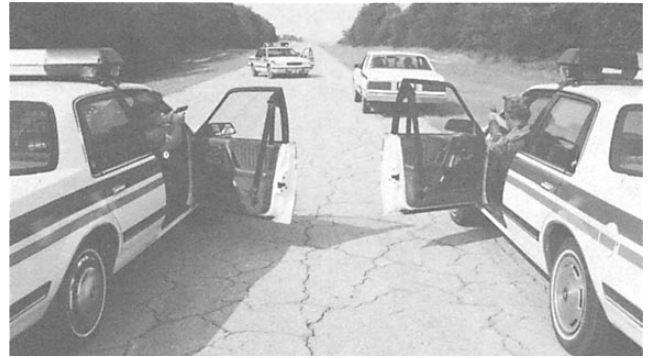

193.163

The forward observer also remains in the vehicle and trains on the suspect vehicle.



193.161



193.164

REMOVAL OF THE SUSPECTS (DRIVER)

Before attempting to remove any of the occupants, the senior person will communicate with all responding personnel to ensure all personnel are ready and in position.

Using the P/A system order the driver to remove their left hand from the windshield, reach over the steering wheel and remove the ignition key.



193.162

A third backup vehicle will block the forward escape of the suspect vehicle and act as the forward observer. Depending on the stop location, the forward observer may or may not be exposed. On normal base roadways, the third backup vehicle should be placed to prevent escape of the suspect vehicle, stop traffic in the opposite direction, and be positioned as to not be in the field of fire of the other MA/security force personnel.



193.165

The driver will then be ordered to extend both arms out the driver's side window, drop the keys to the ground and keep his or her arms extended outside the vehicle.



193.166



197.167

The driver will then be ordered to open the door, from the outside, using the right hand and push the door open. Holding the door open, the driver will be ordered to slowly exit the vehicle and stand up with hands raised above his or her head, once out of the vehicle.

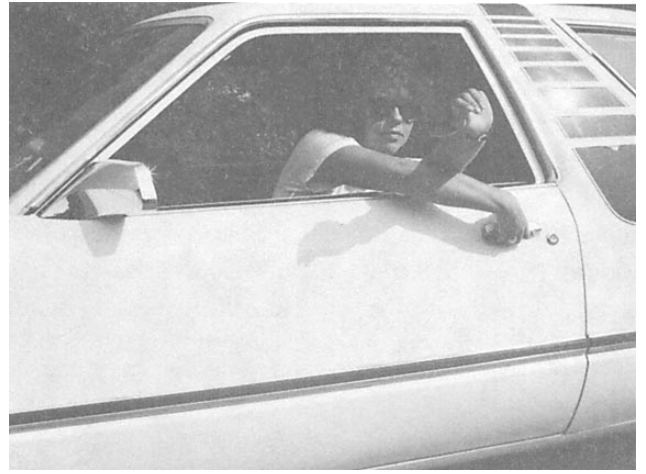

193.168



193.169



193.170



193.171

The driver will then be ordered to step sideways away from the vehicle and clear of the open door. The passenger maintains his or her position with hands still on the windshield. The driver will then be ordered to kick the door closed using the right foot. This will prevent anyone attempting to exit the vehicle without warning and also prevent the driver from attempting to get back into the vehicle.

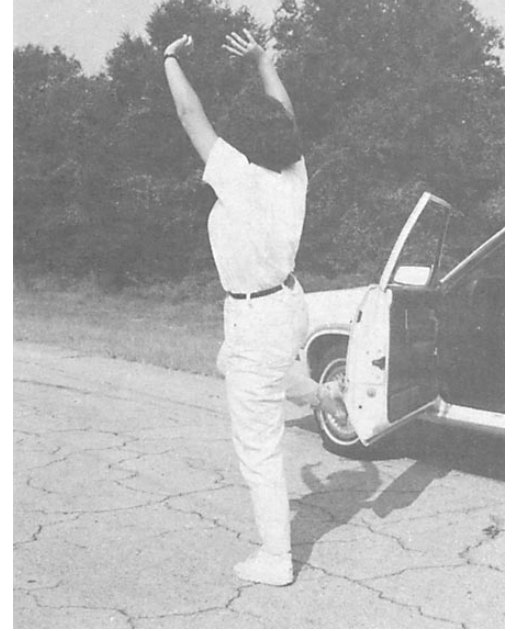

193.173

The driver will then be ordered to slowly turn 360 degrees to be observed for concealment of any weapons. The driver can be ordered to lift his/her shirt in order for MA to see if there is anything in the waist band. Personnel wearing jackets or coats should be ordered to take them off and drop them to the ground immediately upon exiting the vehicle. The driver will then be ordered to return to the position of facing front and away from the patrol units behind the suspect vehicle, and to keep his or her hands above the head.



193.172

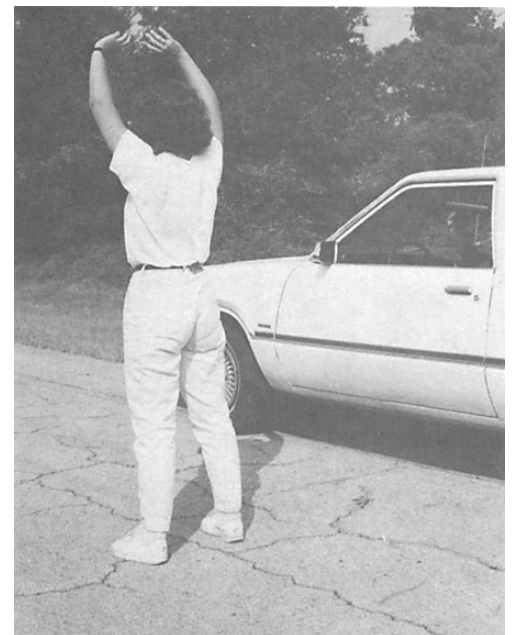

193.174



193.175



193.176

The driver will continue to face away from MAs positioned to the rear of the suspect vehicle. Using the P/A system, the senior person will direct the driver to slowly walk backwards towards the sound of his or her voice. If the stopped vehicle is a van, when reaching the rear of the vehicle, the driver will be instructed to open the rear doors. If the door is locked, the driver will be directed to get the keys, unlock the door, and to throw the keys towards the front of the vehicle on the roadway. Make sure that at no time does the driver turn and face you while the doors are being opened.

The driver will then be ordered to continue moving backwards towards the sound of the senior MA's voice. Once the driver reaches the point between the opened doors of the security vehicles, the driver will be ordered to stop.



193.177



193.178



193.179

The driver will then be ordered to slowly turn around, facing the rear of the patrol vehicles, and moving to a position near the rear tires. The second responding MA will concentrate on the driver; the senior MA will continue to observe the suspect vehicle. At this time the driver will be ordered to a prone position on the roadway with legs spread wide apart and hands behind their back.

The second MA will immediately handcuff the driver and then search the suspect. Proper procedures for the prone search should be followed. (If the suspect is a female, and no female officer is present, a patdown search only may be done by a male officer.) The different types of searches will be discussed later in this chapter.



193.180



193.181

The driver will then be assisted into a sitting position, then stood up, and placed into the MA's patrol unit. The driver will be secured before any other person is removed from the suspect vehicle. The MAs will then return to their original position inside their patrol vehicle.



193.182

REMOVAL OF OTHER INDIVIDUALS (PASSENGER(S))

The procedures for removal of other individuals are basically a repeat of those required to remove the driver. There are, however, several differences:

The passenger will maintain his position until ordered by the senior MA to move. He will be ordered to move into the driver's seat, keeping his hands on the windshield. He will be then ordered to extend both hands out the driver side window. Using his right hand he will reach over and open the door from the outside. He will then be ordered to push the door open and slowly exit the vehicle. Once outside the vehicle he will step away from the door and using his right foot kick the door closed. Again this will prevent anyone from attempting to get out of the vehicle or the passenger attempting to get back in.



193.183



193.184

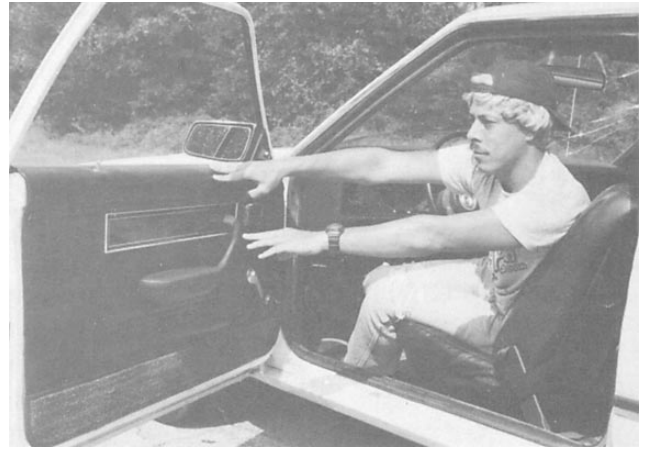

193.187



193.185



193.188



193.186

The passenger will be ordered to continue to face toward the front direction of the suspect vehicle, facing the forward observer. For male or female suspects, if they are wearing loose clothing, instruct them to use one hand (left one, since the majority of people are right handed) to lift the clothing up and away from the waist. If a weapon is discovered, the MA issuing instructions should warn all other persons present and keep the suspect covered. Order the suspect to very slowly reach behind and with his or her left hand, using thumb and forefinger, remove the weapon from his or her waistband. The suspect will then be ordered to slowly bend over and place the weapon on the roadway. The suspect will then be ordered to stand up, keeping his or her hands above the head. At this point, the suspect may be ordered to kick the weapon away, or leave it where he or she placed it, or to step back away from the weapon. The suspect will then be ordered to slowly turn

360 degrees, so the MA can check for any other weapons, and return to a position facing forward again.

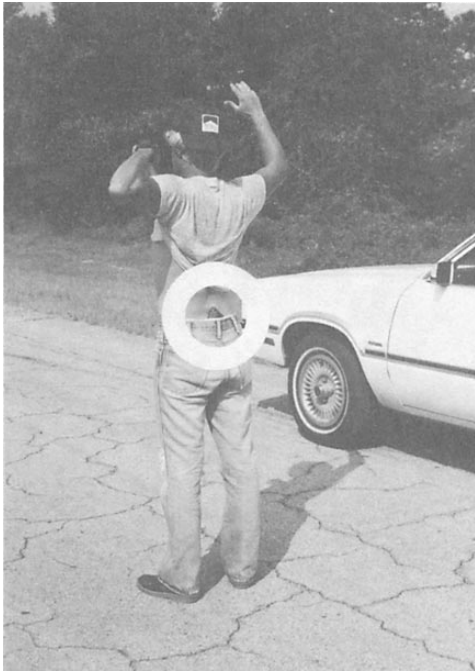

193.189



193.190

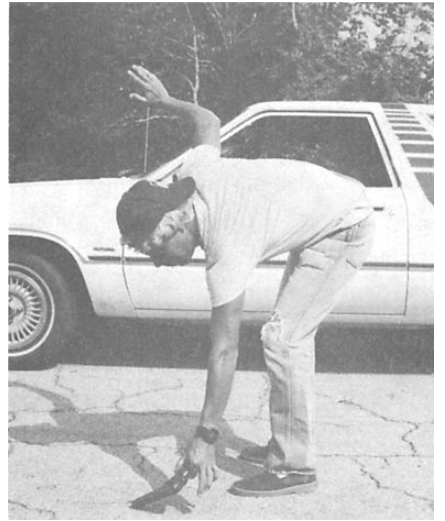

193.191

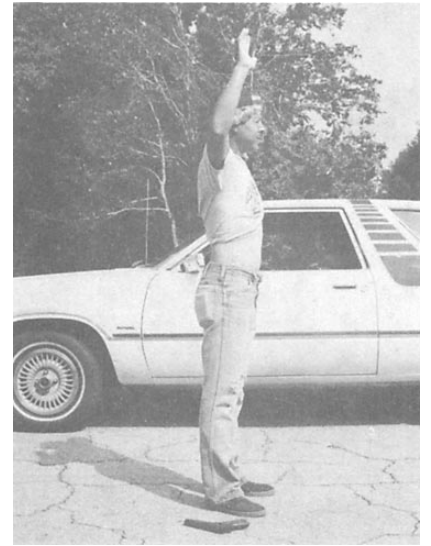

193.192

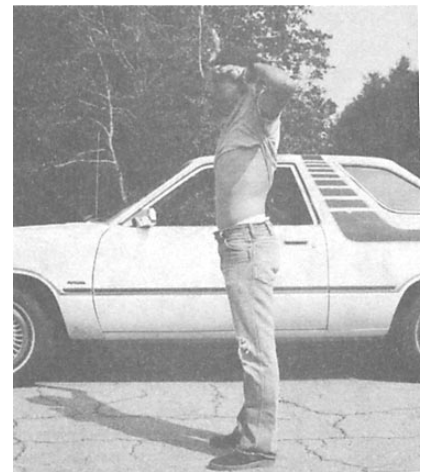

193.193

The suspect will then be instructed to start walking backwards towards the voice of the senior MA and to continue walking backwards until he or she reaches the point of the two opened doors, where he or she will stop. The suspect will then be ordered to turn around, facing to the rear of the patrol vehicles. The MA in the first patrol vehicle will focus on the suspect, while the other MA continues to observe the suspect vehicle. The suspect will then be ordered to walk to a position even with the rear tires on the patrol vehicles.

The suspect will then be ordered to a prone position on the roadway, legs spread, and arms apart. After he/she is in that position, the MA will handcuff and search the suspect. The suspect will then be placed and secured into the patrol unit. With two units you can keep the suspects separated, especially when opposite sexes are involved. This will also prevent them from communicating and pre-planning their stories.

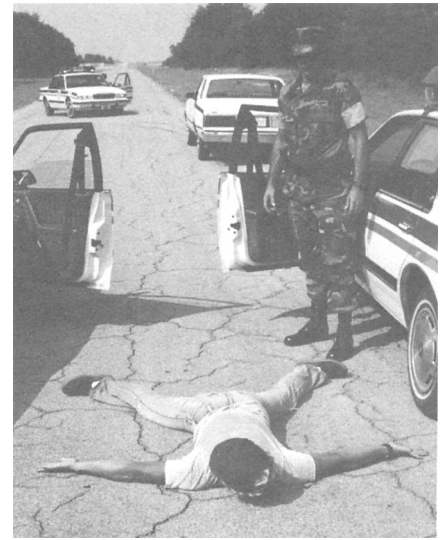

193.196



193.194



193.197



193.195

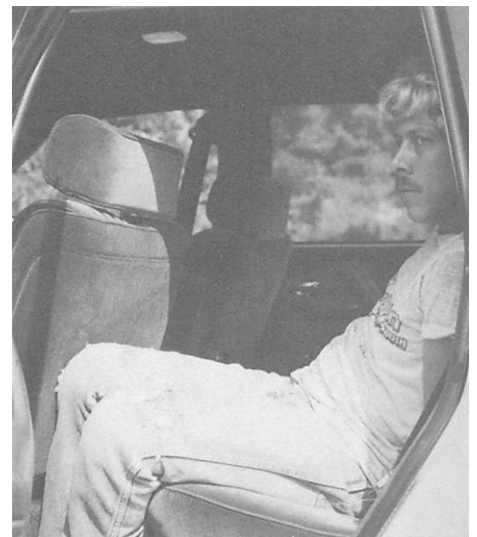

193.198

CLEARING THE VEHICLE

Once all visible suspects are removed from the vehicle, the task of clearing the vehicle for any possible remaining individuals is the next step and probably the most dangerous.

After the visible suspects have been secured, the two primary MA's will resume their position back in their vehicles. The forward observer will then exit his vehicle, keeping his weapon trained on the suspect vehicle. He should move far enough to the right of the suspect vehicle to seek cover if a third individual becomes visible and to stay out of the direct line of fire from the two rear patrol units. Crouching down to present the smallest target, the forward observer will move towards the front of the suspect vehicle and stop at the right front bumper. He will kneel down and place his free hand on the bumper of the vehicle. He is checking for movement in the vehicle and should remain in this position until he is confident that there appears to be no one else hiding in the vehicle.



193.199



193.200

He will then move from the bumper to the right side of the vehicle and slowly stand up training his weapon into the interior of the vehicle. If he observes someone in the vehicle he should immediately drop to the ground and move to the front of the suspect vehicle, using the vehicle for cover. The sequence of events will have to be repeated to remove the other individual from the vehicle. If the vehicle is empty, the forward observer will signal the other MAs with a thumbs up signal.



193.201



193.202

Once the interior is clear, there still remains one area that also has to be cleared—the trunk. To clear the trunk, the forward observer will move towards the right front of the suspect vehicle and the MA in the vehicle directly behind the suspect vehicle, will exit his vehicle and move to the rear of his patrol vehicle.

The forward observer will move to the left front of the suspect vehicle and the other MA will move to the right rear of his patrol vehicle and move out and away

from the vehicle to make his approach to the suspect vehicle. This move must be cautious and careful since now both MAs are in each other field of fire. The MA approaching from the rear has the opportunity to drop and roll if anything should happen and the forward observer has the suspect vehicle to use for cover since any attack would have to come from the trunk.



193.203



193.204

The forward observer will move to a position midway of the suspect vehicle keeping his sight and his weapon trained on the trunk. The other MA now approaches the suspect vehicle from the far right rear. Both MAs position themselves forward of the trunk and to each side with attention directed towards the trunk. Keeping his sight and weapon trained, the forward observer will bend down and retrieve the vehicle keys; the other MA will concentrate on the trunk. The remaining MA will be

guarding and watching the suspects secured in the patrol vehicles.

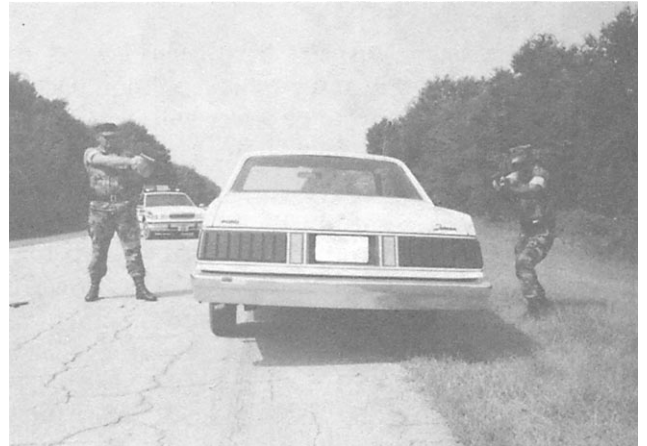

193.205



193.206

Holstering his weapon, the forward observer should drop to the roadway and position himself at the rear of the suspect vehicle, and use the vehicle bumper as cover. The forward observer then inserts the key into the trunk.

Using hand signals, the forward observer will signal the other MA he is about to open the trunk, he will then open the trunk. If the trunk lid does not open by itself, he will have to give it a push. Then, protecting himself using the rear bumper, the covering MA will have the vehicle trunk covered in the event someone is in it and clear the trunk. He will then signal the MA at the patrol vehicles with a thumbs up signal if the trunk is clear and shout "CLEAR" for the MA on the roadway.



193.207

On newer vehicles the trunk may also be opened from the glovebox. Usually a red color button located inside the glovebox on the left side.

High risk traffic stops are extremely dangerous. Don't take any chances. The technique is time consuming, and traffic will be delayed until the evolution is complete, but it is not worth your life or the lives of your shipmates by hurrying, or by assuming that there is little danger because the stop is made on a military installation.

APPREHENSION AND RESTRAINT

LEARNING OBJECTIVES: Describe the procedures and techniques used in apprehension and restraint.



193.208

The way you approach an individual can mean the difference between safe, quiet, and effective apprehensions, and those which are unsafe, draw unnecessary attention, and may fail to result in apprehensions. When approaching a member of the Armed Forces who is to be questioned, corrected for a minor offense, or apprehended, your first words will either control the situation or create a disturbance.

A smooth, courteous, and efficient approach, and a firm, but friendly, conversational tone usually can calm all but the most violent offenders.

A suspect is either cooperative or not. An uncooperative attitude is a good indication that an apprehension is necessary and that force may be required. By anticipating trouble before it occurs, the Master-at-Arms is in better position to take immediate action. A cooperative attitude, in itself, is not always an indication of innocence. Experienced offenders sometimes appear to be model sailors.

Keep your voice low, but distinct, with a tone of quiet authority and friendliness. Never make individuals feel they are being placed in a situation they must fight their way out. Members of the Armed Forces should be questioned as privately as possible, away from crowded areas. One Master-at-Arms does the questioning or apprehending; the other stays in the background ready to assist his or her partner, if necessary. When an apprehension is necessary, it must be made immediately.

USE OF FORCE

When making an apprehension, only such force as is necessary should be used. If the apprehension cannot

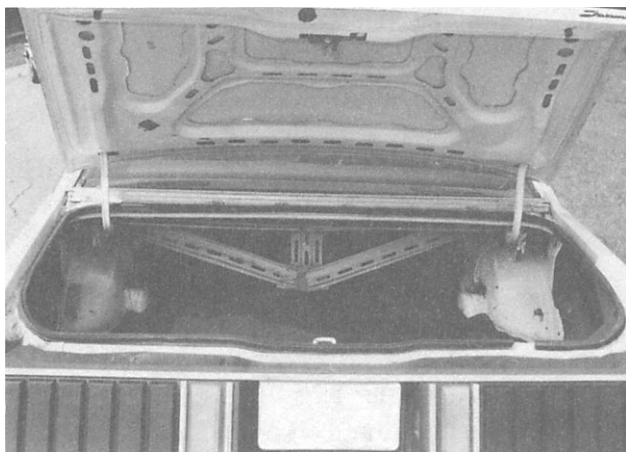

193.209

be made without the use of force, use the MINIMUM amount of force necessary. The use of excessive force makes one liable to prosecution by law.

The use of deadly force must be used only in situations where no other alternatives exist. Deadly force is that force inflicted upon another person for the purpose of causing substantial bodily harm or death. Its use is justified only under conditions of extreme necessity, when all lesser means have failed. The use of deadly force is discussed in chapter 9 and in SECNAV INSTRUCTION 5500.29.

USE OF EQUIPMENT

As previously mentioned, an MA is never justified in treating an offender with unwarranted violence or resorting to dangerous methods if the apprehension can be executed otherwise. In extreme circumstances, you may have to use authorized items of police equipment in effecting an apprehension.

Firearms

You must exercise great caution and judgment in the use of firearms; only extreme necessity justifies the taking of a human life. As stated before, the use of firearms is authorized ONLY when all other means of accomplishing the mission have failed. Never draw firearms to use as a bluff or to communicate a threat. Remove your pistol from its holster only when its use is imminent and justified. The use of firearms against an individual who has committed a minor offense is not justifiable. A serious offense justifying the use of firearms is one attempted by force or surprise.

Although firing on persons in the act of committing a serious offense is legally justified under certain circumstances, you must consider, before shooting, the nature of the offense, your own safety, and the safety of persons in the area. These considerations generally will indicate what actions should be taken.

In attempting to halt a fleeing suspect, DO NOT fire warning shots. If the suspect fails to stop after the command HALT has been repeated once, consider before firing whether the offense is serious enough to warrant such action. Shots should NEVER be fired if they may possibly endanger innocent bystanders. The burden of proving the necessity will rest upon you.

Since personnel stationed overseas may be subject to the jurisdiction of the local foreign courts, you must be especially knowledgeable of the conditions and circumstances in which the use of firearms is legally justified under the local laws in those areas. In many cases, these laws are different from, and more restrictive

than, provisions of United States law. Firearms are covered in chapter 8 of this manual.

Handcuffs

Each time patrolmen perform an apprehension, they must assume that the person in custody may be dangerous and may become violent. Therefore, police personnel must rely upon their judgment, training, and experience in determining the need to handcuff the offender. It is not necessary, or desirable, to handcuff all persons apprehended.

Handcuffs should be applied when the offender is to be transported by a lone patrolman or in any case where the apprehending patrolman has reason to believe restraint is necessary.

Handcuffs are only temporary restraining devices and do not make a person helpless. The apprehended person still can use his or her head, body, and to a certain extent, his or her arms.

There are many ways handcuffs can be opened without keys, so never relax your vigilance just because the offender is wearing them.

So that you can place the cuffs on the offender as quickly as possible, keep them ready for instant use by wearing them as follows:

1. Keep them in a pouch, with the locks on opposing sides and the linking chain up. Keep both ratchet arms toward the belt buckle.
2. Wear the pouch on your belt, so that they are instantly accessible to you, but out of open view where the offender might easily grab them.

When you handcuff an offender, always secure his or her hands behind the back palms out, and double lock the handcuffs.

WARNING

If the offender has his or her hands cuffed in front, he or she has a potent weapon for striking or strangling you.

For additional control, use a belt to secure the offender's hands to the body. Be sure the belt buckle is out of reach of the offender's fingers.

When you must transport a handcuffed person in a vehicle, buckle him or her in with a seat belt. This is done for that person's safety as well as your own.

WARNING

Never handcuff anyone to a fixed object while traveling in a vehicle, aircraft, and so forth. Federal law prohibits handcuffing prisoners to any fixture on a vehicle or railroad car.

To apply the handcuffs, place the suspect in one of the handcuffing/search positions that are later discussed in this chapter.

Chemical Aerosol Irritant Projectors

Chemical aerosol irritant projectors are extremely useful tools when properly used and when their function is understood. They should be used only in situations where the use of force is absolutely necessary to control violent behavior, and only as an alternative to more extreme application of force. They should never, under any circumstances, be used indiscriminately or punitively. If improperly used, these weapons may cause some degree of physical injury. (Even if they cause nothing more than psychological shock, their potential must be recognized.)

Experience has shown that even the best control irritant is not equally effective on all persons. You should not become overconfident with the use of aerosol irritants because you could be caught off guard if you encounter an individual who is not adversely affected by the irritant.

Units that locally purchase an aerosol irritant should ensure that they are getting the best quality product. Many dispensers have been marketed, most with similar appearances in markings and containers. Improperly made or tested agents could cause permanent injury.

Aerosol irritant projectors should be used only after all reasonable efforts to control a violent person have failed. If the irritant is used to effect an apprehension, the areas of the body exposed to the liquid should be flushed with water as quickly as practicable.

When these irritants are used for crowd control, efforts should be made to caution affected people to flush exposed areas. (Many police departments use preprinted cards that can be handed to persons who have come into contact with the liquid. Others have standard procedures for making public address announcements.)

Regardless of the situation, the use of irritants under the following conditions requires that the subject be taken to a hospital for immediate emergency treatment:

1. Discharge at any effective distance into the eye or face at very close range (less than 2 feet).

2. Prolonged discharge at any effective distance into the face of an already incapacitated person, or a person not responding to normal applications of the irritant formula.

3. Discharge of large quantities in a confined space, such as a small room or a closed automobile.

Projectors must never be discharged in the immediate vicinity of infants, as their respiratory systems are especially sensitive to irritating vapors.

POLICE BATON

The police baton is a highly effective and versatile individual defensive weapon. It allows the user to maintain a defensive nonaggressive posture. The baton is to be used in a quick reaction defensive mode as an extension of the arm and hand and is used primarily to poke or jab. It is also used to apply come-along holds.

Some of the advantages of the police baton are the following:

1. The baton is immediately responsive to the minimum force requirement.

2. It can be rapidly removed and immediately used with one hand.

3. It can be effectively used in riot control formations.

4. The dimensions of the baton are constant throughout, thus eliminating any weak point.

The use of the police baton is presently being taught at MA training school at Lackland Air Force Base. Marine cadres attached to security departments are also available to provide proper training.

The police baton is 26 inches long, constructed of high-density, straight-grain, second-growth hickory or oak, or of high-impact plastic. It is 1-1/4 inches in diameter, rounded at both ends, and weighs no less than 15 but no more than 18 ounces. The baton is equipped with a snug-fitting rubber grommet positioned 8 inches from one end of the baton (fig. 12-3). A 1 1/2-inch-diameter ring holder is provided which is attached to the belt by means of a short leather strap.

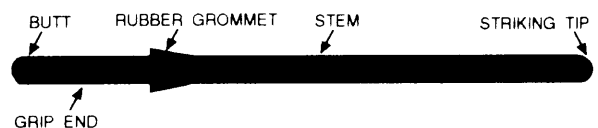

Figure 12-3.—Police baton.

Any come-along described herein may be accomplished using the baton. The baton in the hands of alert patrolmen who have been trained in its use is an excellent weapon for defense. Since very few situations will justify the use of the pistol, the baton is designed to be used as a weapon that will preclude use of the pistol and prevent a last resort situation where deadly force must be used.

Bear in mind that knowledge and practice create confidence; not only in your own ability but also in your equipment. Self-confidence and the belief that you are right can overcome the natural fear that you may experience in the performance of your duties. Controlled fear will work for you and help you to control a violent situation; however, uncontrolled fear leads to panic, which can cause you to disregard all values of human life except your own. A panic-stricken patrolman cannot control his or her own actions, much less those of others.

Normal Usage of the Baton

Always keep the baton with you during your tour of duty; it is of no use to you when left in the patrol vehicle. Always keep your baton in the ring until you must use it. Never use it as a toy or to impress or frighten anyone. The baton may be used in either hand and is easily adapted for two-hand usage in close quarters for jabbing or pushing. Learn through practice to use the baton in both left and right hands for the execution of come-along techniques. When striking an offender with the baton, use it in your strong hand for speed and control. The baton may also be used as an extension of your arm for blocking or parrying blows that an offender may throw.

If the situation warrants, striking an offender with your baton will always be with the intention of temporarily disabling the offender and never with the intention of permanently injuring or harming the offender. Use only enough force to create pain and momentarily disable the offender in order to apply handcuffs or overcome resistance.

Assumed (Ready) Position

Grip the baton firmly by the grip end. From this position, hold the striking tip of the baton in your free hand, with the knuckles of both hands facing out as seen in figure 12-4. Two inches of the baton should extend from either hand. Hold the baton parallel to



193.210

Figure 12-4.—Assumed position.

the ground. You have now taken the “assumed position.” The following directions apply to persons that are right-handed as shown in figure 12-4; the position of the legs are reversed for left-handed persons.

If you are facing an offender, place yourself about one arm’s length away from your opponent’s right side, at an angle of about 45°. Your left leg should be slightly forward and slightly bent. Your right leg should be vertical, with most of your body weight on this leg. From the “assumed position,” all striking movements described will provide an instantaneous response, for defense as well as offense.

Striking Areas

When using the baton, strike at the fleshy areas of the body (such as the buttocks, arms and legs); other striking areas are the joints (elbows, knees, and wrists) and the bones (forearms, shin). Do not strike the head, spine, tailbone, or upper solar plexus (area just above pit of stomach). Blows to these areas could cause death or great bodily harm. Remember that the baton is an extension of your arm. The vulnerable points of the body in which impact with the baton should be made are depicted in figure 12-5.

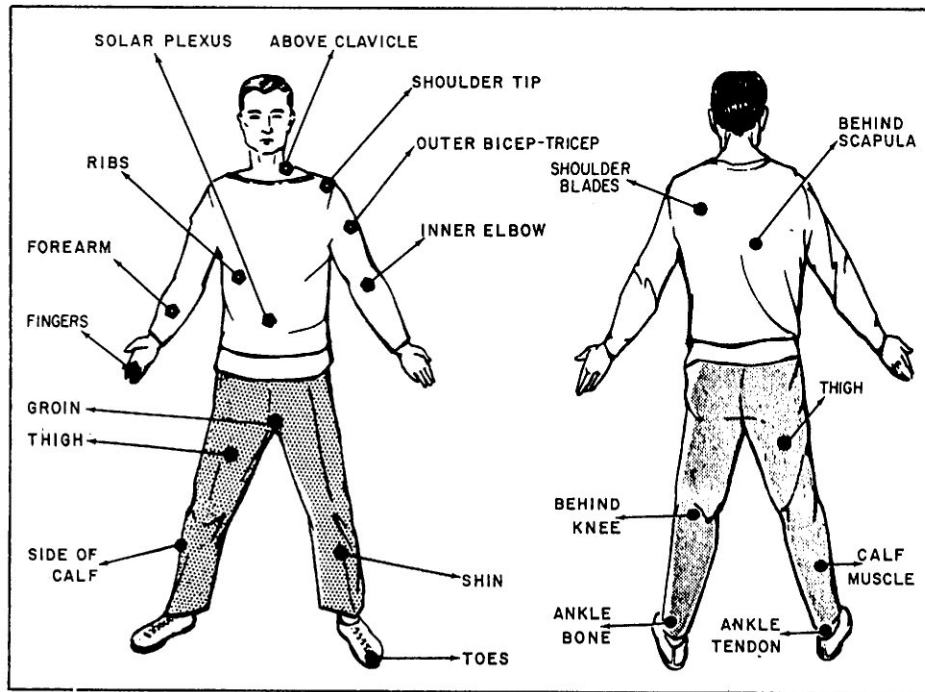

Figure 12-5.-Striking Areas.

Defensive Movements

All the defensive movements described here begin from the assumed position. They provide you an instantaneous response to an attack, and effective methods for quickly discouraging a violent offender.

CHEST OR OVERHAND ATTACK.— Your suspect has drawn a knife and is coming at you with an overhead, downward thrust towards your chest. As the offender's arm is coming down, bring your arms up and out as shown in figure 12-6. This must be done in a quick snapping (hard thrust) motion. Your striking area should be between the offender's wrist and forearm. Between the combination of the offender's downward thrust and your upward snap, blocking it, this action will cause the offender to drop the knife. (NOTE: Be careful in practice. As you will find out, just doing this slowly will bruise your partner. If done with enough force, you could break your partner's wrist). If you need to follow through after blocking, bring the baton around to your right in a circular motion, and strike at either the chest or kneecap area.

UNDERHAND THRUST ATTACK.— If the offender starts an upward thrust, slam your arms downward at an angle, striking the offender's wrist area

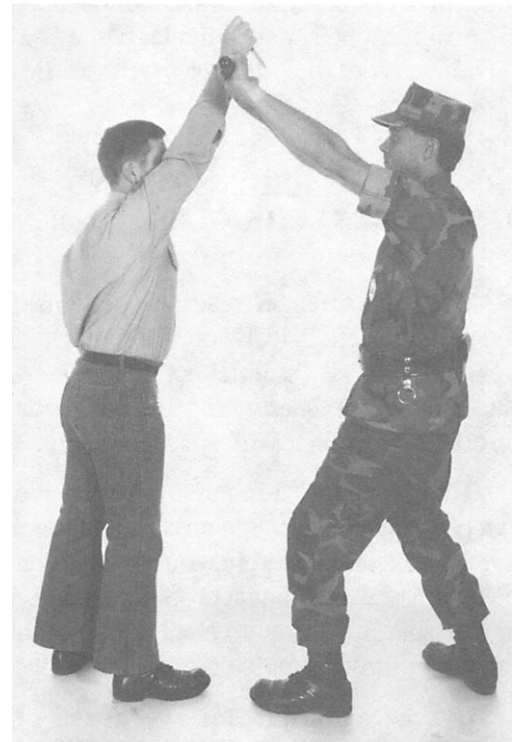

193.211
Figure 12-6.—Chest or overhead attack.



193.212

Figure 12-7.—Underhand thrust attack.

as depicted in figure 12-7. This will cause a very sharp pain, forcing that person to drop the knife.

SLASH ATTACK.— Should an offender attack you with a sweeping sideward motion, snap your baton to a position that is perpendicular to the ground, striking the bony part of the offender's wrist as shown in figure 12-8.

PHYSICAL APPREHENSION AND RESTRAINT TECHNIQUES

When an offender resists apprehension by force, you will find certain techniques are invaluable when you are unarmed. It is essential not to apply any more force than necessary. Once you use one of the techniques described here, do it with speed and surprise.

The most critical moment is when you make your first physical contact. You are most vulnerable to attack at that moment. Therefore, you must protect yourself by executing the technique properly and swiftly. Never signal your intention to apply the technique, either vocally or through undue motion.

If the technique fails because of improper application, lack of speed, or by signaling your intent—you cannot try it a second time—the element of surprise is lost. If you fail the first time, you may be compelled to use force or a more drastic measure. Avoid

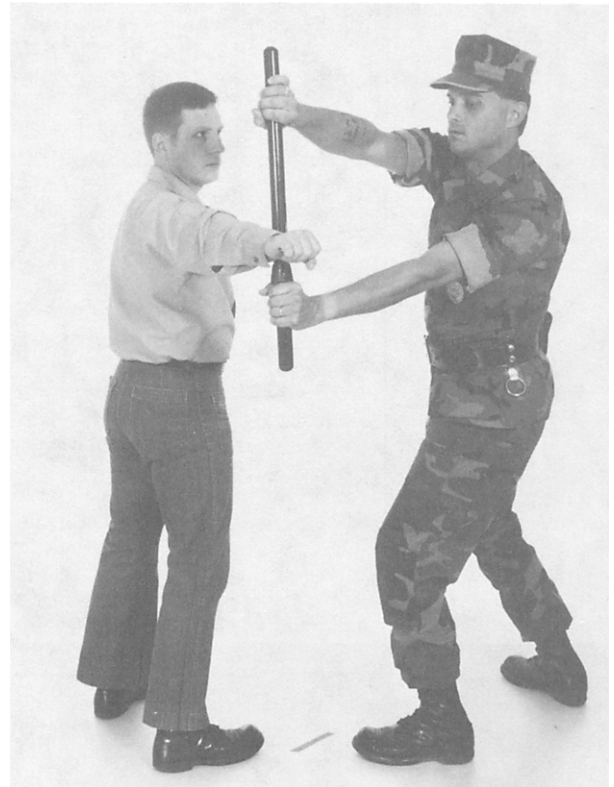

193.213

Figure 12-8.—Slash Attack.

this by developing the highest proficiency in using the techniques describe here. (**NOTE:** All of these techniques are shown by a right-handed person. Left-handed persons should reverse these procedures.

Come-Along Holds

The come-along holds described in this chapter are effective in removing a violent offender from the scene of an apprehension.

First, take the interview stance, which is similar to the assumed (ready) position previously discussed (without the baton). To refresh your memory, the interview stance is established by facing the offender, placing yourself about one arm's length away from your opponent's right side, at an angle of about 45°. Your left leg will be slightly forward and slightly bent. Your right leg will be vertical, with most of your body weight on this leg. Always use this position when confronting a person, whether you intend to make an apprehension or only to question someone. This position is the most natural and suitable because the person you are talking to will normally be facing you and your stance will not look aggressive. It is suitable because you can move or

strike in any direction with minimum motion and effective speed.

The following two variations of come-alongs are an effective means of taking an offender from the scene of an apprehension should the offender refuse to come along. Even though these holds are simple, you must remember that to obtain proficiency, you must practice and maintain efficiency.

REAR ARM BAR.— From the interview stance, slip your left hand (thumb up) under the offender's right arm, with the back of your left wrist pressing against the inside of the offender's right elbow. With a slight turning motion to your right while on the ball of your left foot, bend the offender's right forearm upward toward his/her left shoulder. At the same time, slip your left hand high enough to lock his/her right elbow by grabbing the upper arm. Now secure your hold of the suspect in one of two ways. Put your right arm around the front of the suspect's neck and grab the left shoulder. Another effective measure is to pull his or her head backward by pulling the hair until the suspect is on his or her toes. One word of caution, when you practice with your partner, be careful as this hold, and the one described in the following paragraph can be painful.

PRESSURE POINT BAR.— This come-along is extremely simple but effective if applied properly. There are two key points you must remember when applying this hold. First, you must know how to locate a pressure point. One is about 2 inches past the elbow toward the armpit area. The second thing to remember is when you put your arm over and around the suspect's arm, use the bony part of your forearm to apply the proper pressure to the pressure point. This hold is applied when, if in the interview stance, the offender turns away from you, or if you have approached the offender from the side in a confrontation situation.

Grab the opponent's left wrist from the inside, pulling it slightly towards you, so that the arm is away from the body, and the palm in an upward position. Swing your right arm over the person's upper arm (just past the elbow) locking your hand against your chest. Now apply pressure on the suspect's arm by forcing it downward and twisting the wrist. Once the pressure point is applied correctly, the suspect will be on his or her toes, and the body will be arched backwards.

DEFENSE AGAINST CHOKE AND BODY HOLDS

Contact attacks have the largest variety of applications, but also require the least degree of skill to

overcome. The most common are: front and rear hold, front and rear chokes, and headlocks.

The most sensible technique of self-defense is to retreat in the face of an attack. However, the responsibilities of your duty will not allow this. Neither can you limit your action against an attack. Instead of merely defending yourself against an attack you must become the aggressor when attacked.

When placed in the role of the aggressor, however, your objective is NOT to destroy or maim your opponent; it is to overcome resistance to your lawful actions and to secure custody of the offender. The need to apply unarmed defense techniques when attacked at close quarters requires no further explanation or qualification. It would be as difficult a task to present here all known defenses for attacks as it would be for you to learn them. The following defenses are some of those you may be able to use in the situations described

Front Choke Hold

The offender has grabbed you around the throat and has started to choke you. With your hands at your side, bring them together, clasping your fingers to form a fist, bringing them straight up. With a powerful upward thrust, you should have broken the choking hold. Once the hold is broken, bring your clasped hands in a downward motion, striking the bridge of the nose. (**NOTE:** When doing this as practice, be careful with your partner. This can be very painful.) Another method of variation to this defense, is basically the same as previously mentioned, but instead of coming through the middle of the offender's arms, raise your arms overhead and clasp your hands together. With a powerful downward motion, smash your clasped hands into the offender's face and forearms. Follow up this move with a swift kick to the groin area. This will stop any aggressive move from the offender and give you a chance to regain your breath.

Rear Choke Hold

The offender has approached you from behind and has put his or her right arm (forearm) around your throat and is starting to crush your windpipe. The first thing you **MUST** do is turn your head into the crutch of that elbow. This prevents the person from crushing your windpipe and allows you to continue breathing. Next, twist slightly into that person (left to right) and reach up with your left hand and grab that person's shirt or coat. Take your right hand and do the same, but somewhat higher up. Now that you are somewhat sideways to the

offender, throw your hip into the offender's stomach, and give a powerful forward and right to left twisting motion. With this motion, you have not only broken the hold, but the person is now flat on the ground.

Front Body Hold

If you are grabbed from the front under your arm, you can do several things since your arms are free. However, if an offender grabs you from the front and pins your arms down, immediately slide your right foot to the rear and flex your knees to maintain your balance. Then strike the offender in the groin to make the offender break his or her grip. Encircle your left arm under and over the top of the offender's right arm with the palm of your left hand on top of his or her triceps muscle. Break the offender's balance by gripping the back of your left hand with your right hand and pull him or her forward and down into you. Place your left elbow in the offender's back then follow through with a rear arm lock.

Rear Body Hold

If an offender grabs you from the rear, immediately lower your weight by flexing your knees, shift your hips to the left and control the offender's arms by encircling your arms up and over the top of his or her arm. Stomp the instep of the offender's right foot with your right foot. Strike the offender in the groin with your right elbow. Grip the offender's right wrist with your right hand, sidestep to the right rotating his or her arm up and over your head as you sidestep. Twist the right wrist clockwise into your right hip; at the same time, grip the elbow with your left hand. With pressure on the elbow, sidestep to the right and take the offender to the ground; then drop your left knee in his or her back. Follow through with a rear arm lock.

Unarmed self defense is also presently being taught at MA training school at Lackland Air Force Base. Marine cadres attached to security departments are also available to provide proper training.

TECHNIQUES OF SEARCHING

LEARNING OBJECTIVES: Describe the various types of searches and the procedures and techniques used.

It is necessary to have a practical, working knowledge of the techniques of searching an offender.

Normally, three types of searches are used-standing, kneeling, and prone. We will discuss when and how a complete search of a suspect is done. Also covered will be simple and complete vehicle searches and premises searches.

When you believe a person to be armed or when you consider the person to be dangerous, proceed with the utmost caution. The following list of DON'Ts provides practical advice for the Master-at-Arms.

1. Don't be unnecessarily rough. Be firm and let the offender know you are in command of the situation.

2. Don't let the offender delay or make excuses. Insist that your orders be obeyed immediately.

3. Don't grant any requests until the search is completed.

4. Don't stand too close to an offender when you are armed-the offender may grab your gun.

5. Don't talk too much. Make your orders clear and concise.

6. Don't permit anyone to come between you and the offender. Keep away from pedestrians when streets are crowded and remove the offender from the street as soon as possible. While on a sidewalk, keep the offender between you and the buildings. If no better place is available, take the offender into a doorway.

7. Don't allow offenders to separate; keep them together. Keep the offenders between you and your partner.

8. Don't permit the offender to face you. If you think he or she is dangerous, make the offender turn away from you. Never place a gun against an offender even from behind, because he or she may attempt to take it away from you. Never go within kicking or striking distance of an offender when you have a gun in your hand.

9. Don't let an offender get the upper hand during the apprehension.

Now we will discuss and walk you step by step through the different types of Handcuffing/search positions.

STANDING REAR CUFF AND SEARCH POSITION

1. With subject facing you, identify yourself and explain that subject is under apprehension. Have subject put his arms straight out, parallel to the deck palms up, feet shoulder width apart. Instruct subject to turn slowly until he is told to stop (approximately 180°). You are

looking for telltale signs or bulges that could reveal concealed weapons.

2. Instruct subject to stop turning when he is facing away from you. Have subject put his palms together behind his back with his fingers interlaced - backs of his hands against his back.

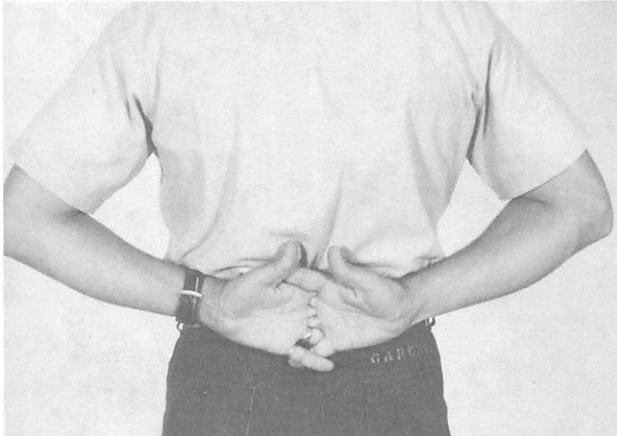

193.214

3. Instruct subject to move his hands (still interlaced) slightly away from his back toward you. Step in with your offhand ready to grab, strong hand up ready to protect you if necessary.



193.215

4. Grab subject's interlaced fingers with your off hand from the top. Make sure to grab deep enough so that all of your fingernails are showing to the rear and your thumb is over his. Next grip subject's hands and torque them backwards.



193.216



193.217

5. Grip cuffs in the middle with both single bars facing forward. Move subject's hands over to the right side of his body, maintaining enough torque backwards on his hands to maintain control.



193.218

6. Place the bottom cuff on the subject's right wrist and push it on. After cuffing the right wrist, relax the torque enough so you can slowly separate the subject's hands.



193.219

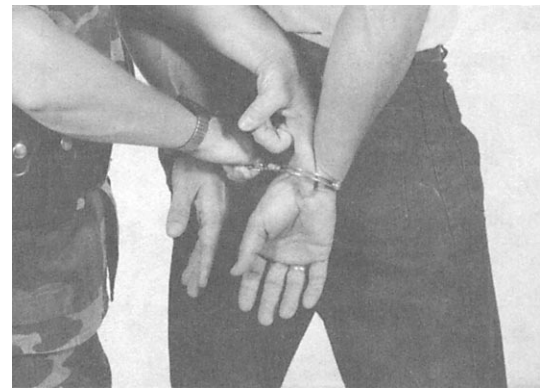

193.222

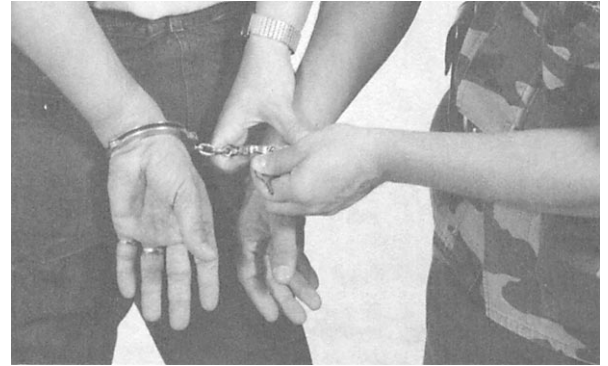

193.223



193.220

8. Have subject move his feet apart as far as possible. Grasp the handcuffs with your left hand and pull the subject's hands and arms slightly away and down from his body. Place your left knee behind subject's right knee, instep of your left foot beside subject's right instep. Search the small of the back first.

7. As the hands separate, maintain control of the right wrist with the handcuffs. Position the cuff on his left hand and push it on. Check the gap (tip of the index finger tight and double lock them).



193.221

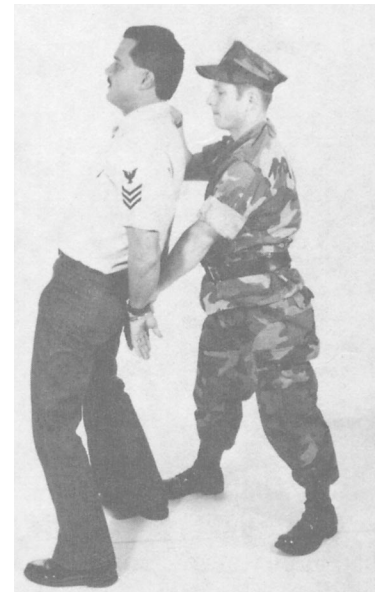

193.224



193.225

9. Divide subject's body in half lengthwise. Start at subject's head and work down to his feet on half of his body. Use crushing and squeezing method to search every area of his body. Pay particular attention to his waist and groin area. If you think you forgot to search an area, research the entire side again. Be consistent and thorough throughout your search.

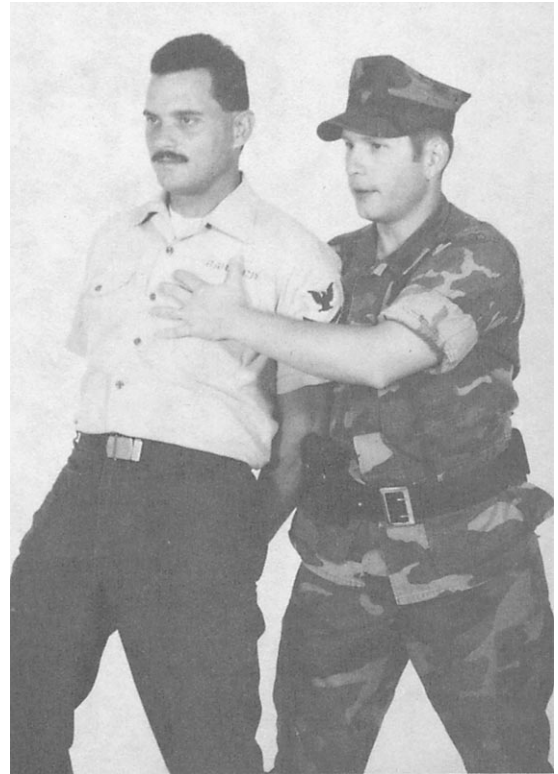

193.227

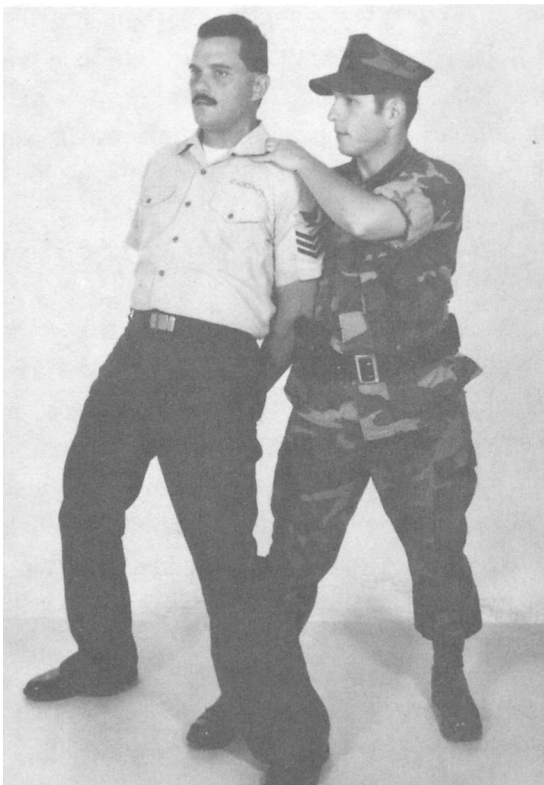

193.226

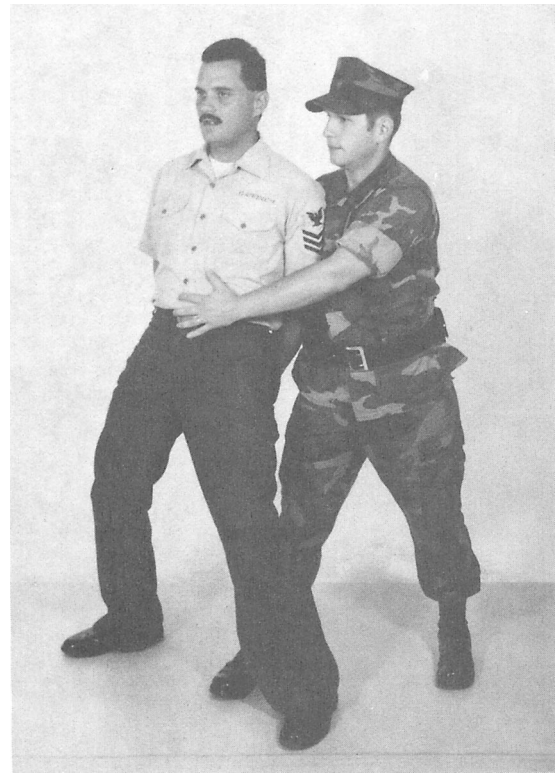

193.228

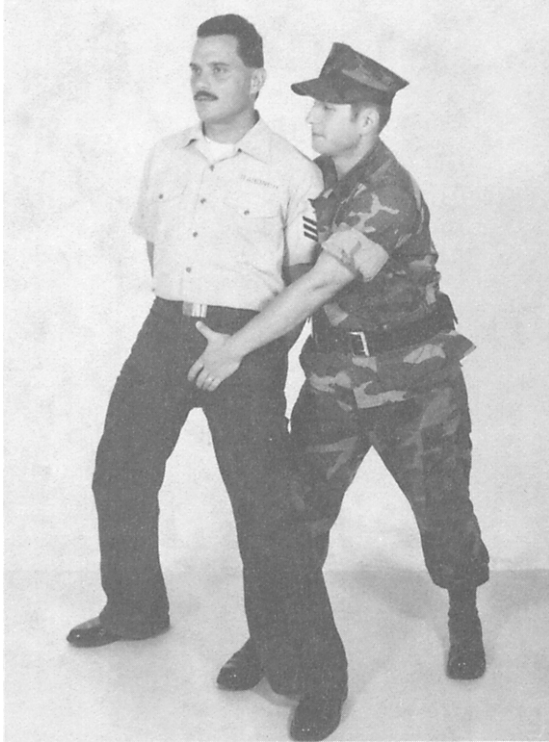

193.229

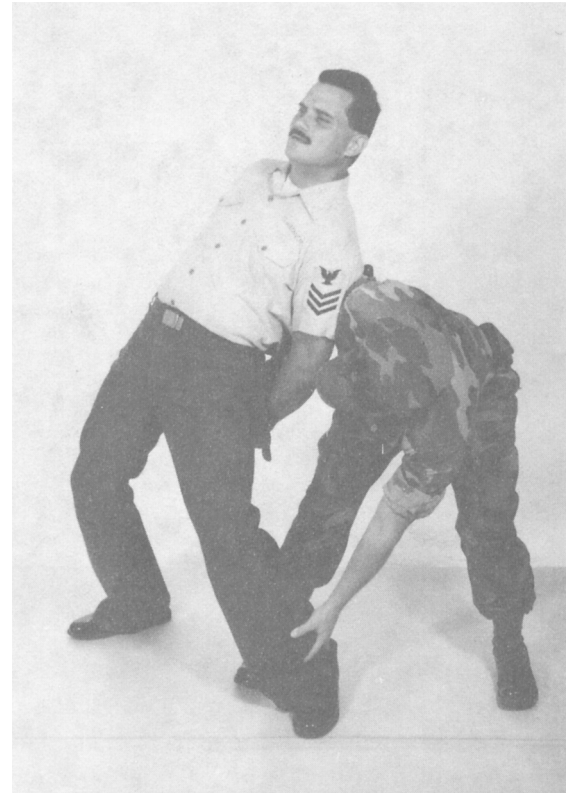

193.231



193.230

10. When you complete the right side of his body switch your hands on the handcuffs. Then place your right knee behind subject's left knee, your right instep should be on the inside of his left instep. Repeat the above steps to complete the search of the subject.

KNEELING HANDCUFF AND SEARCH POSITION

1. With subject facing you, identify yourself and explain that subject is under apprehension. Have subject put his arms straight out, parallel to the deck palms up, feet shoulder width apart. Instruct subject to turn slowly until he is told to stop (approximately 180 degrees). You are looking for telltale signs and bulges that could reveal concealed weapons. Instruct subject to stop turning when he is facing away from you.

2. Have subject place his hands on top of his head, thumbs down, fingers interlaced. Instruct subject to place one knee on the deck. Instruct subject to place his other knee on the deck. Now have subject cross his ankles and sit on them.

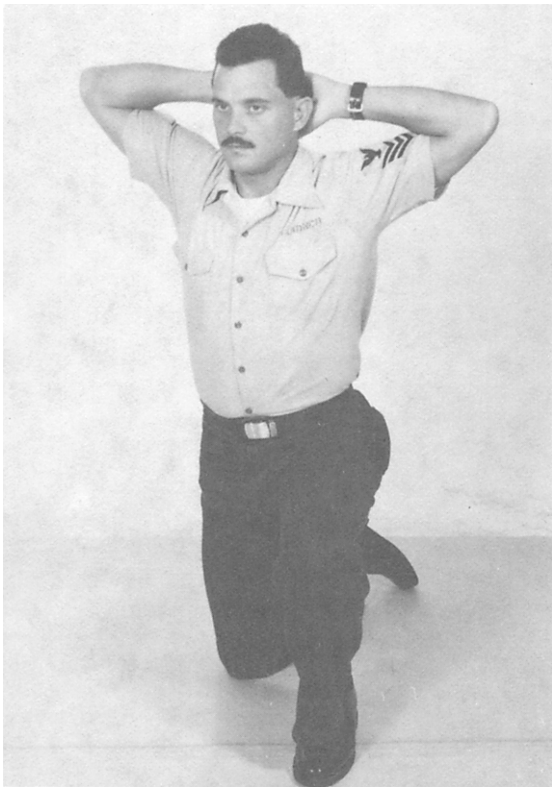

193.232

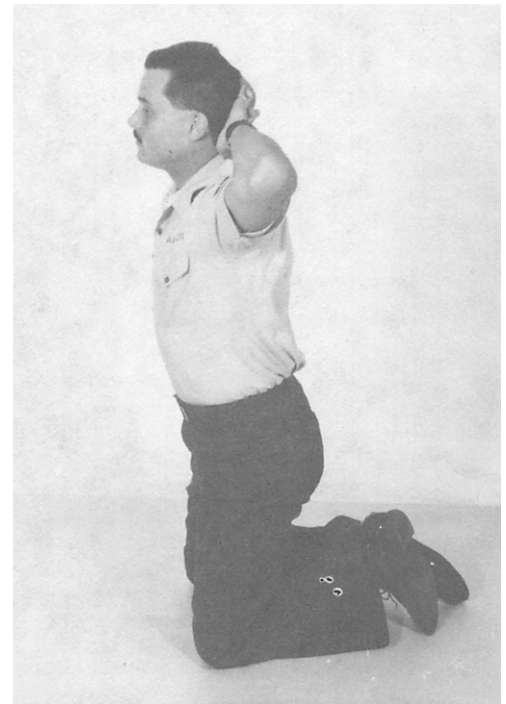

193.234

3. Place your left foot between subject's feet. Grasp his interlaced fingers with your left hand. Retrieve handcuffs with your right hand. Instruct subject to turn his head slightly to the left.

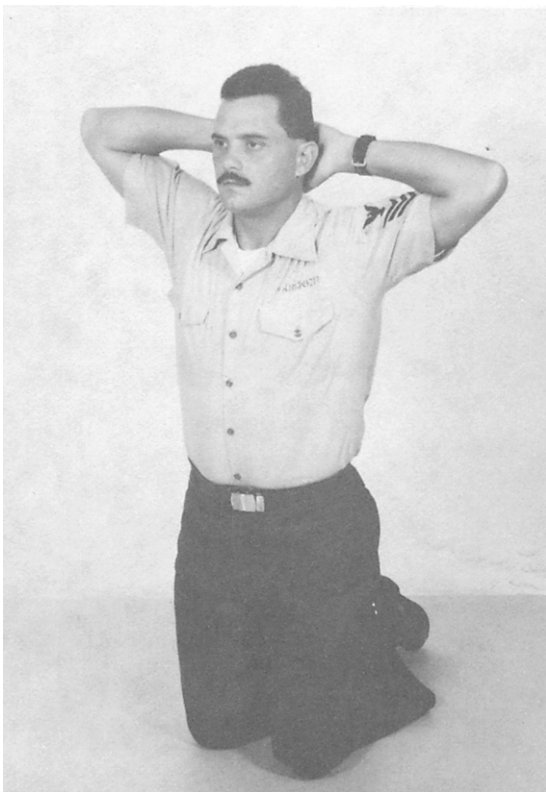

193.233

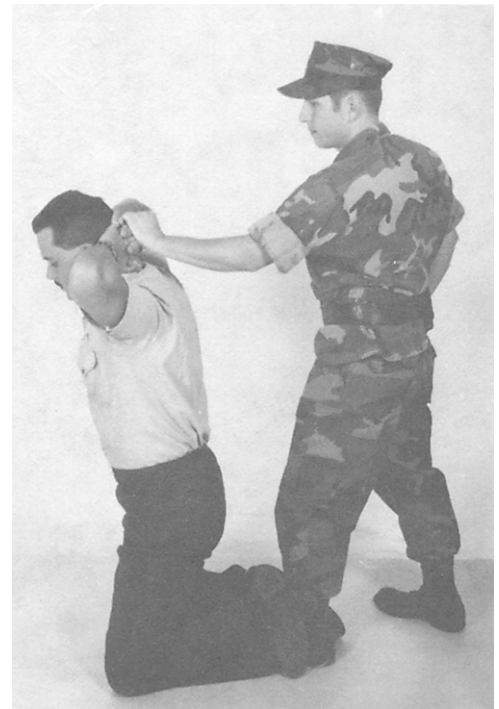

193.235

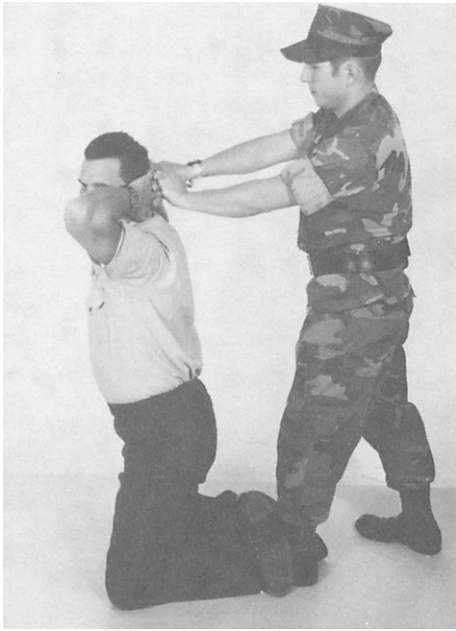

193.236

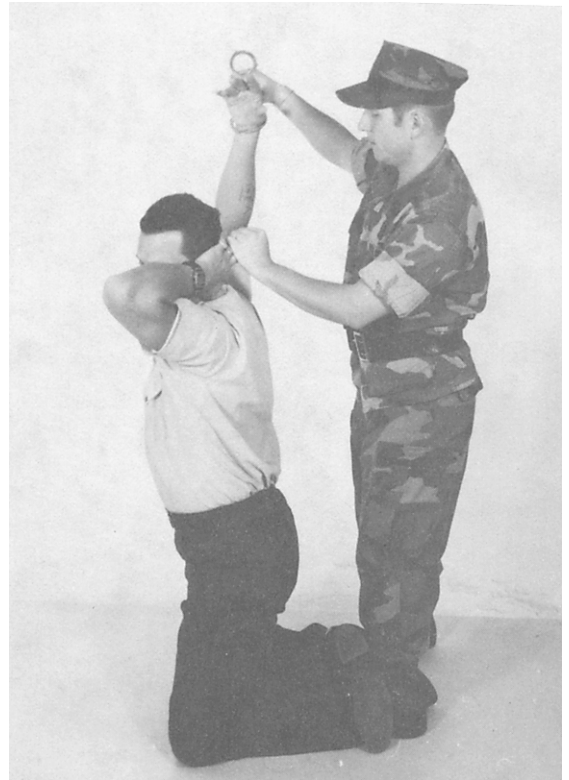

193.238

4. Cuff his right wrist in an upward motion (single bar of cuffs toward overhead). Reposition the handcuffs so that they are perpendicular to the deck single bar away from you. Bring subject's cuffed wrist behind his back with your right hand (maintain control of the handcuff). Your arm should be between his arm and back.

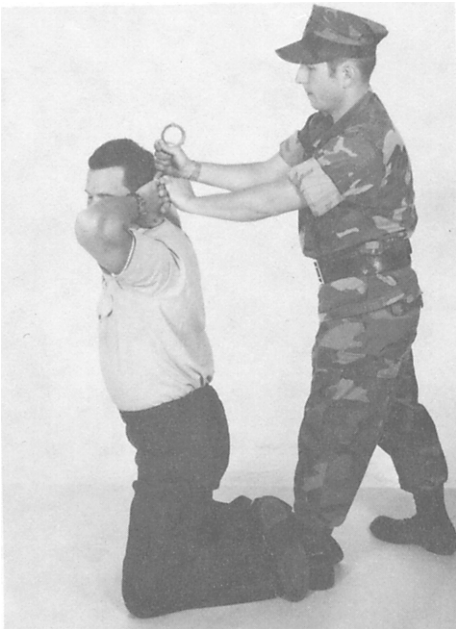

193.237

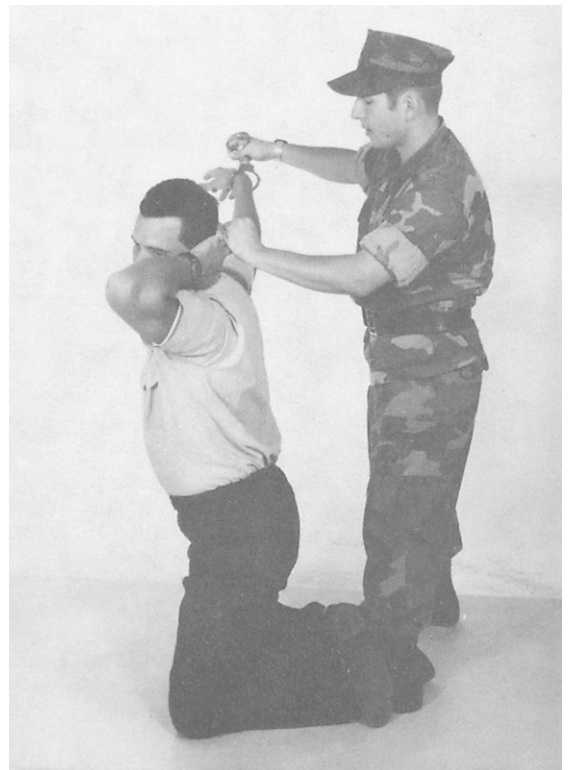

193.239

5. Bring subject's left wrist to the small of his back with your left hand. Cuff left wrist and tighten handcuffs as necessary. Use tip of your index finger at the inside top of the double bar to make sure that the cuffs are not too tight. Double lock handcuffs.

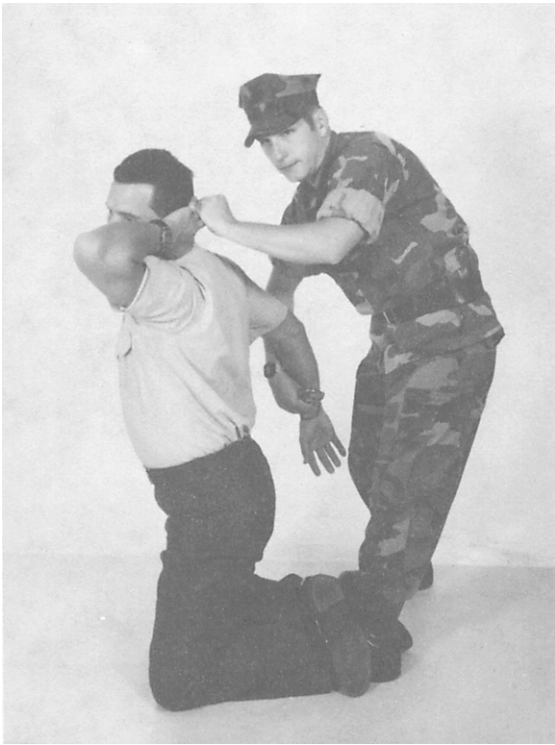

193.240

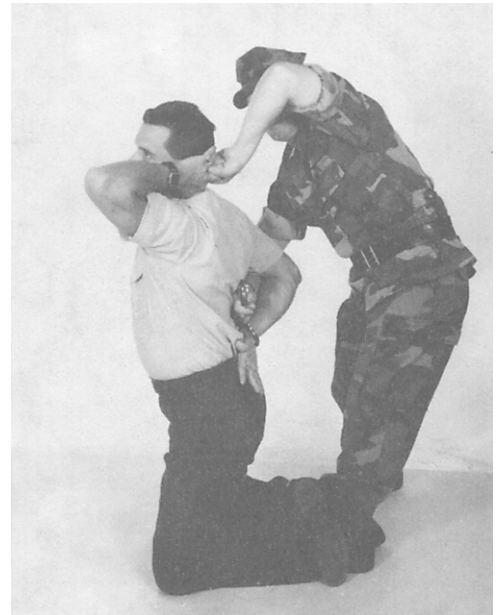

193.242

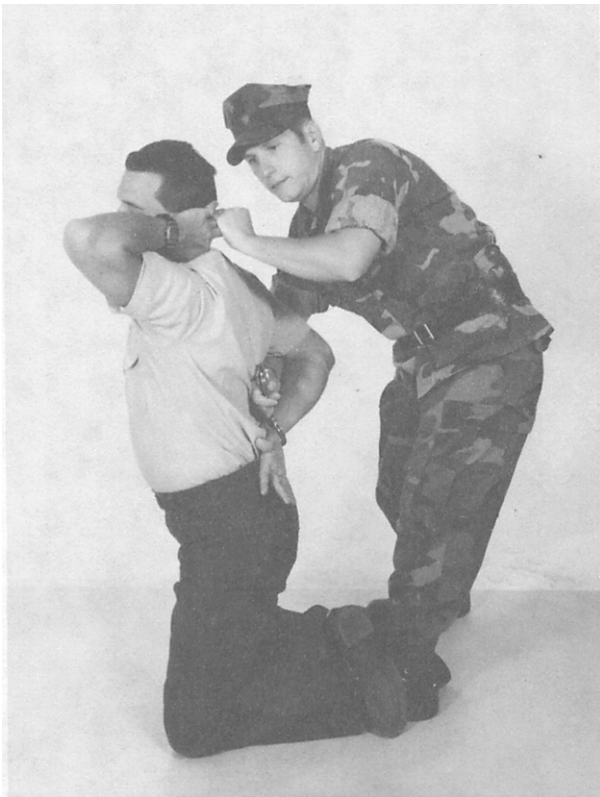

193.241

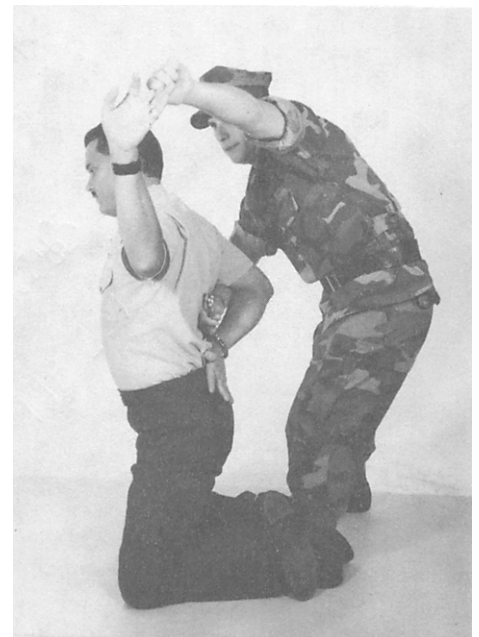

193.243

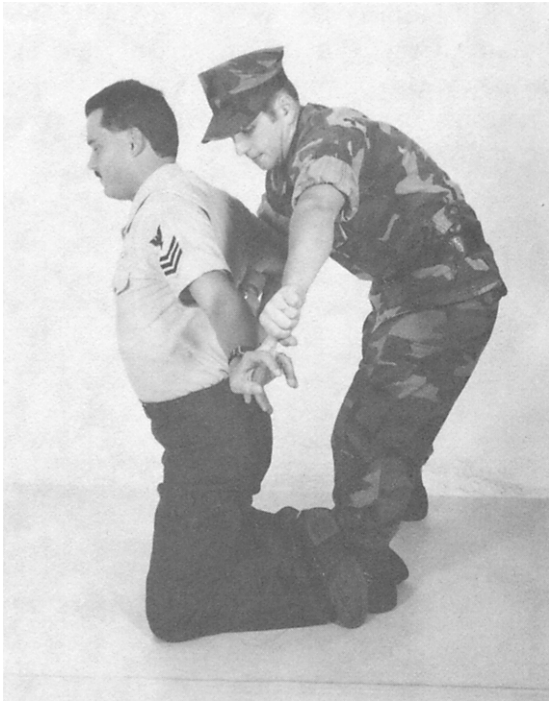

193.244

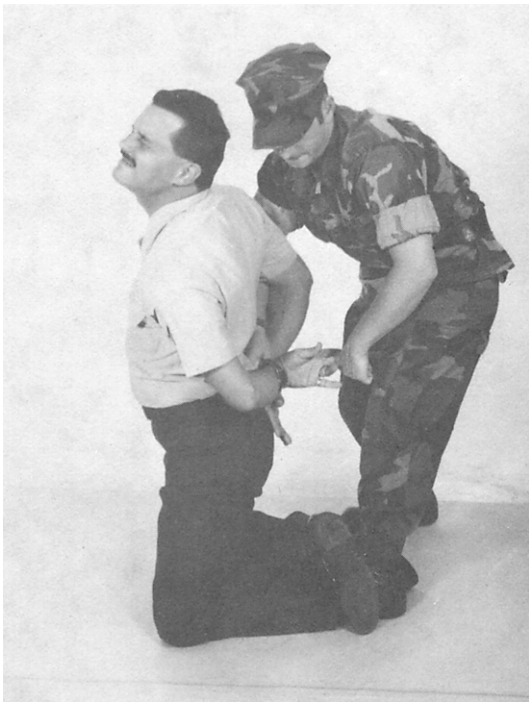

193.245

6. Have subject uncross his ankles and stay in the kneeling position. Instruct the subject to come up on one knee. Instruct the subject to stand on the count of three. Count out loud; one . . . two . . . on "three", slightly push subject on the upper backup and away from you.

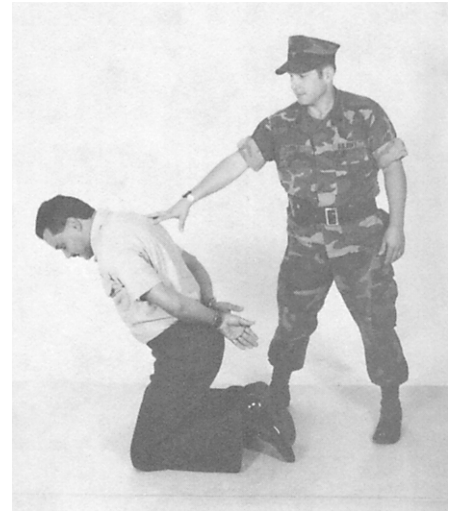

193.246

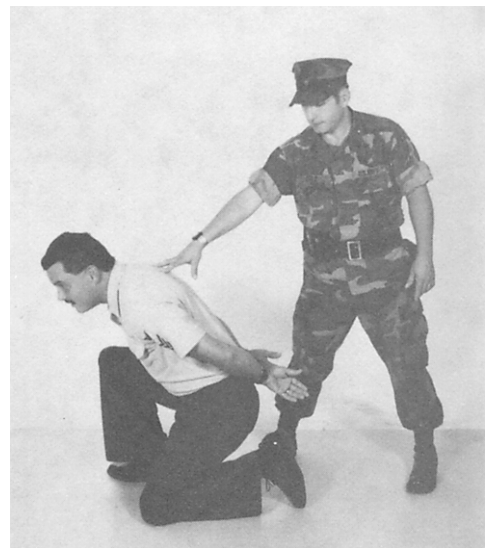

193.247

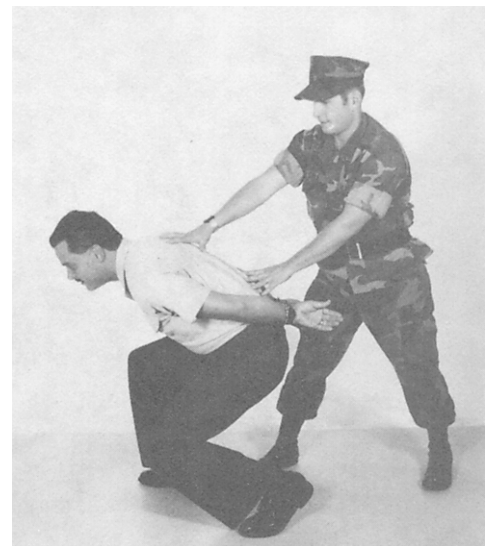

193.248

7. Grasp handcuffs with your left hand and search subject as you would in a standing position.

PRONE HANDCUFFING AND SEARCH POSITION

1. With subject facing you, and at least 10 feet away, identify yourself and explain he is under apprehension. Have subject raise his hands above his head (as high as possible). Ensure his hands are open - fingers outstretched. Have subject turn slowly until ordered to stop (approximately 360 degrees). You are looking for telltale signs and bulges that could reveal concealed weapons. Order subject to stop turning when he is again facing you.

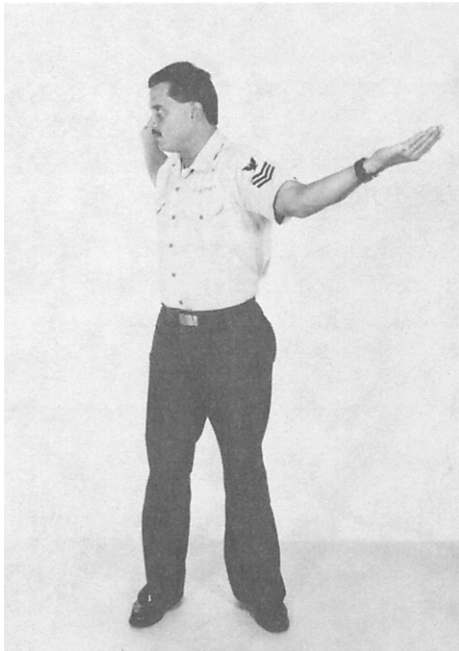

193.249

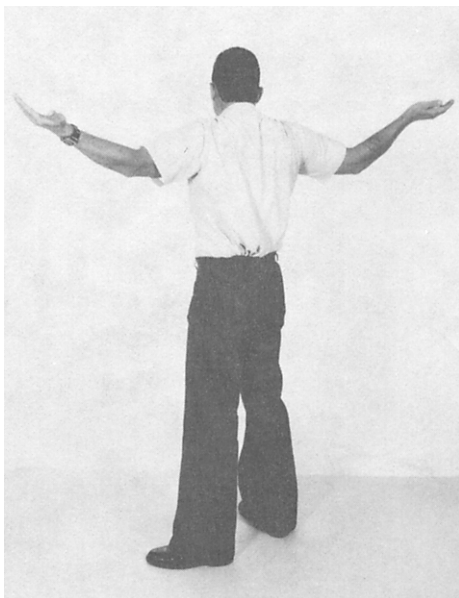

193.250

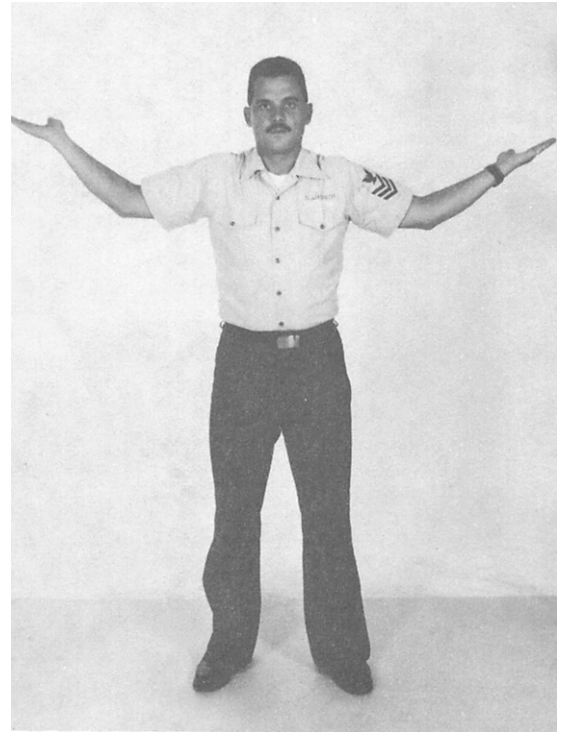

193.251

2. Order subject to go down on one knee, then the other knee - with the subject's arms still above his head. Order the subject to place both hands on the ground in front of him.

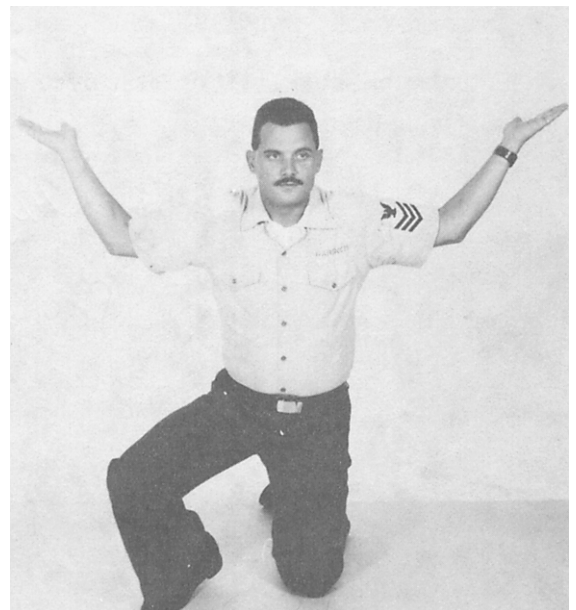

193.252

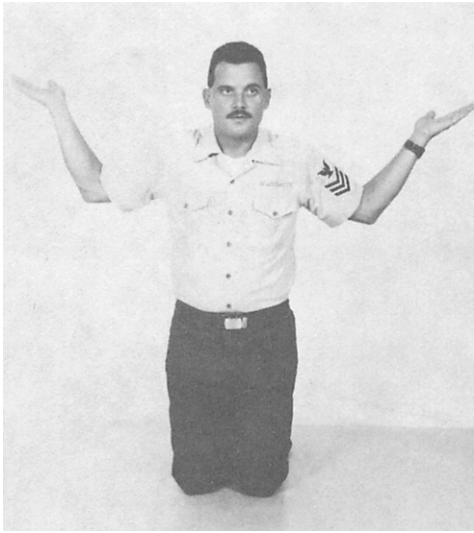

193.253

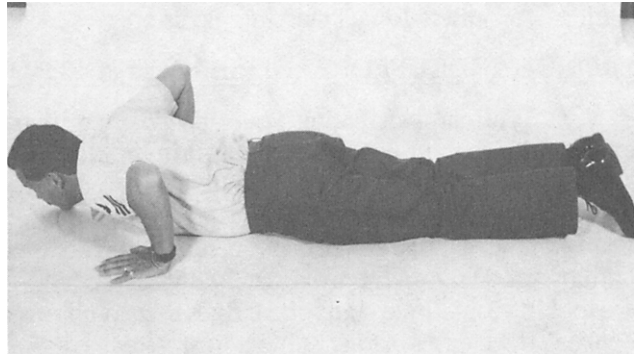

193.256

OPTION: AT THIS POINT YOU CAN HAVE THE SUBJECT CROSS HIS ANKLES, **OR** HAVE SUBJECT SPREAD HIS FEET APART AS FAR AS POSSIBLE.

4. Order subject to extend his arms to the side (90 degrees from his body), palms up. Order subject to turn his face opposite your approach.



193.254

3. Order the subject to slide his body to the rear, until his is lying flat on the ground.

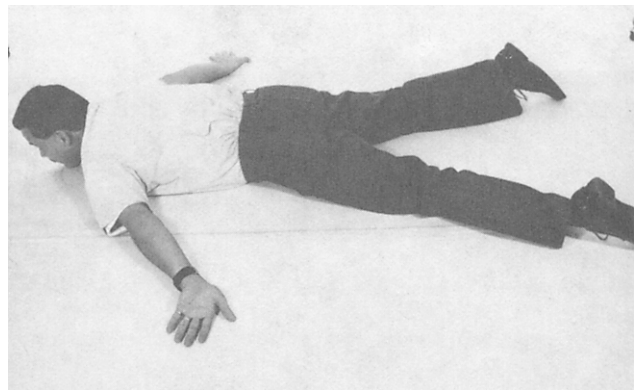

193.257

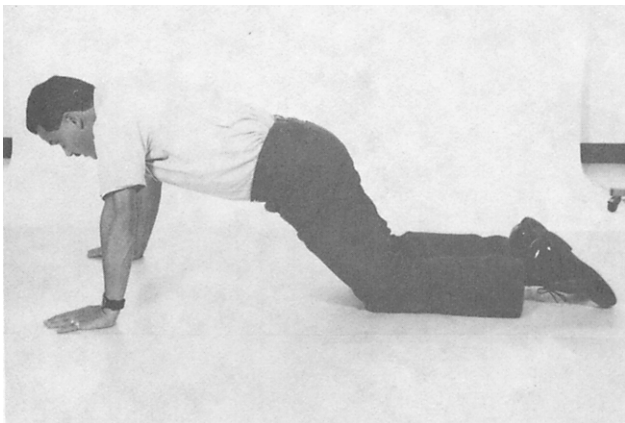

193.255

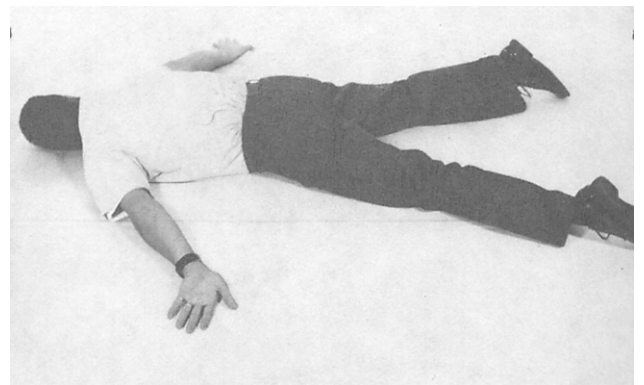

193.258

5. Approach from a 45 degree angle from the front. Crouch at the subject's hand and obtain a bent wrist. Raise subject's arm high and toward his head.

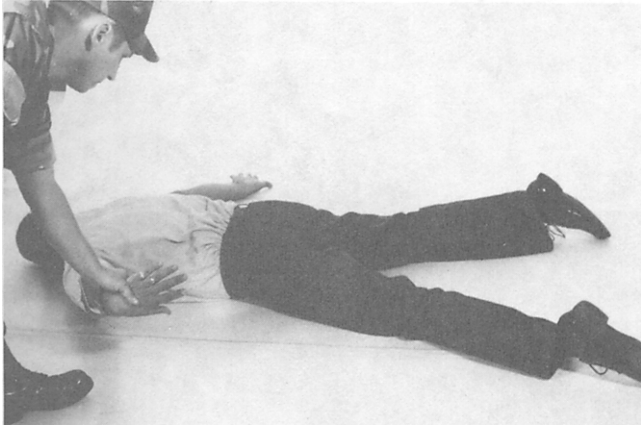

193.259



193.260

6. Lower your knees onto subject's back and nape of his neck (subject's arm should be between your legs, his hand should be in the center of your chest).

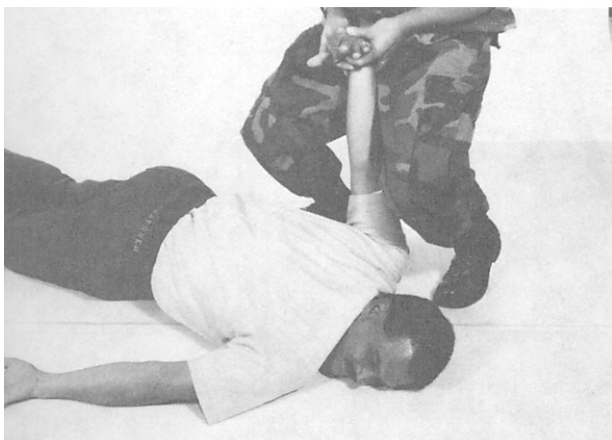

193.261

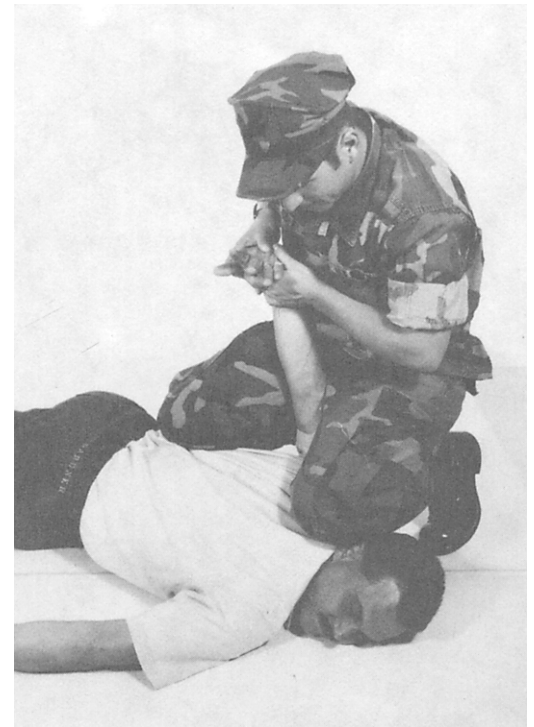

193.262

7. Apply handcuff to "captured" arm. Keyhole of cuff should be toward back of subject's hand. Maintain bent wrist and bring it to the small of his back

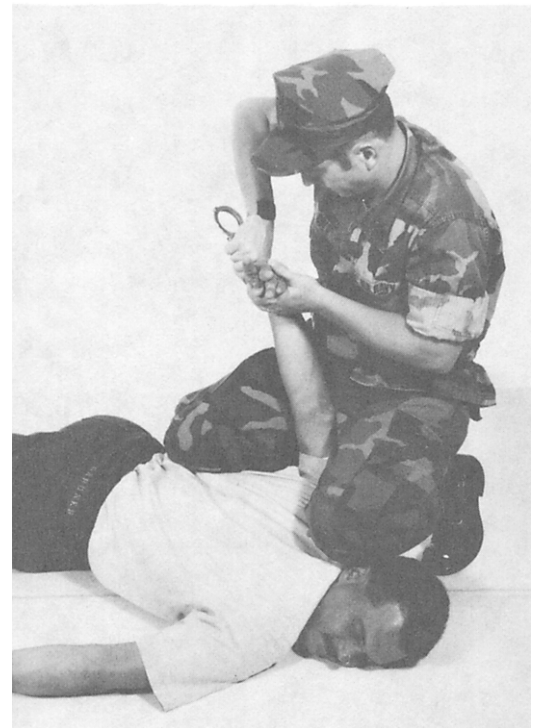

193.263

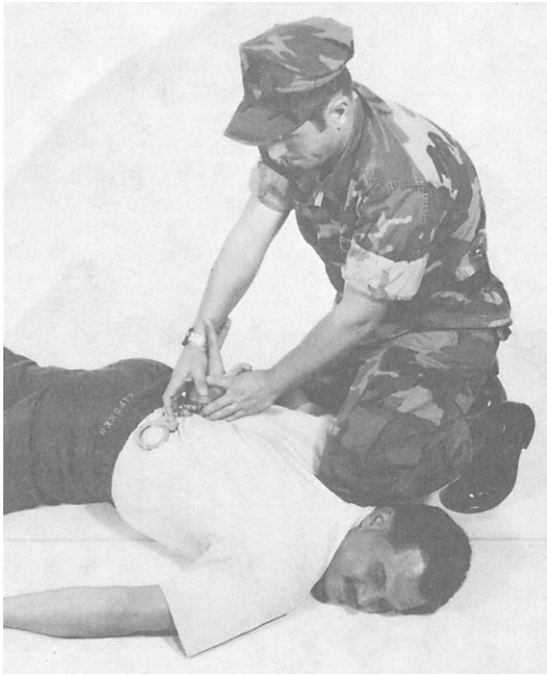

193.264

8. Instruct the subject to bring his other hand to the small of his back. "Shake hands" with the subject's uncuffed hand by grabbing it at the first knuckles. Apply the other cuff and adjust tightness of the handcuffs. Activate double locks on both cuffs.

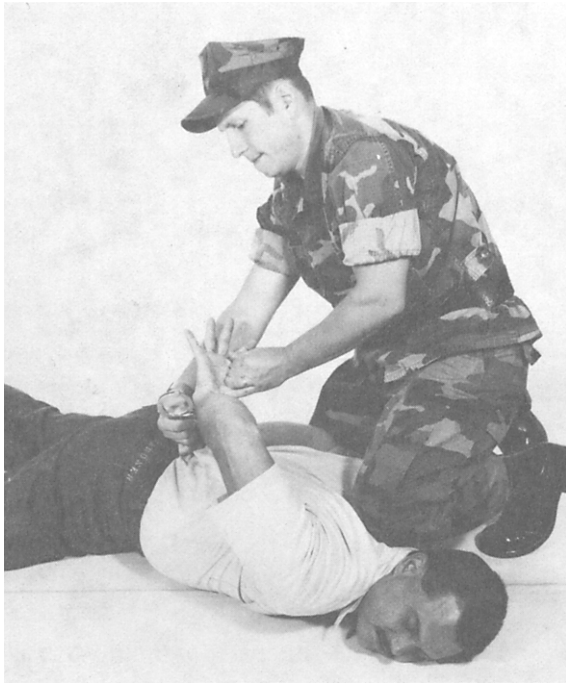

193.265

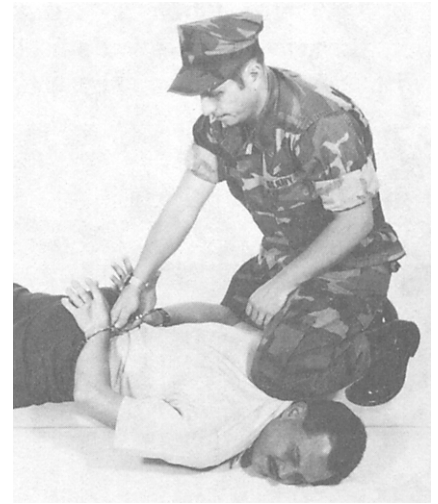

193.266

9. Search the small of the back first. Next grasp the inside of the subject's closest elbow and far shoulder. Roll subject onto his side so he is facing away from you. Place his elbow farthest from the ground over your knee closest to his feet (this knee should be raised).



193.267



193.268

10. Search subject from his collar down as far as can be easily reached. Use a crushing, squeezing method to search the subject. Pay particular attention to the waist and groin areas.



193.269



193.270

11. Once you've searched as far as you can reach, command subject to slowly bring his foot toward you (one farthest from the ground). Grasp the foot and search from the knee down, checking the edge and sole of the footwear. When you have completed that side, release his foot and return the subject to laying flat on the ground.



193.271

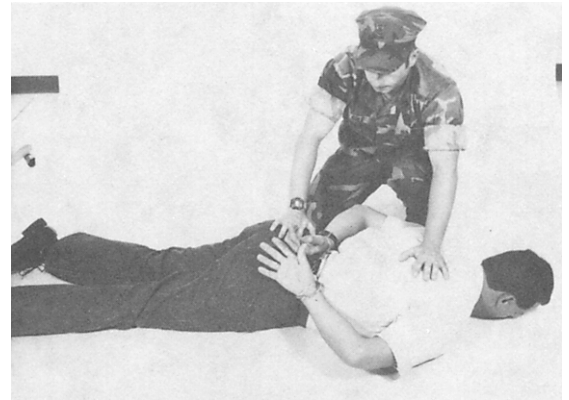

193.272

12. Walk around the subject's head (never his feet), keeping one hand placed between his shoulder blades. Tell subject to turn his head away from you. Now search this side in the same manner as described above.

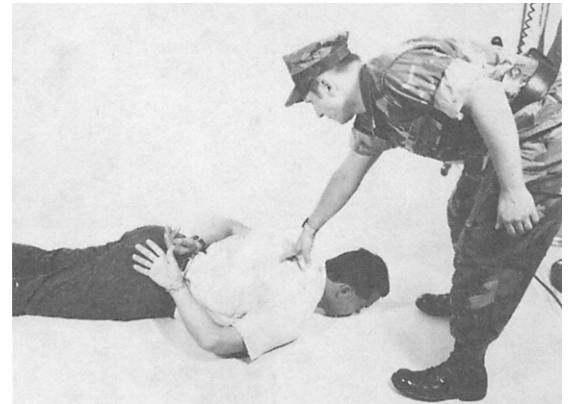

193.273

13. Place one hand on the back of the subject's head and far shoulder. Turn the subject so that he assumes a sitting position. Order the subject to tuck a foot into his groin area.

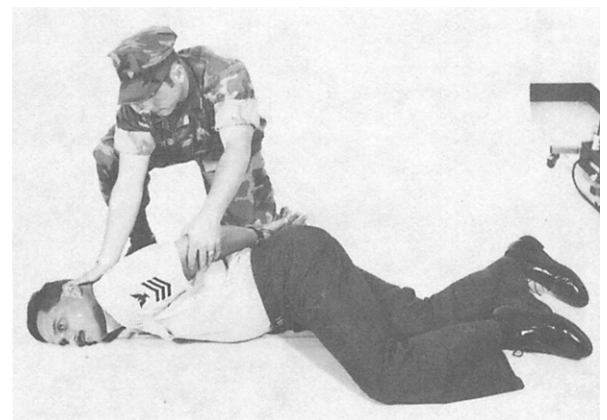

193.274

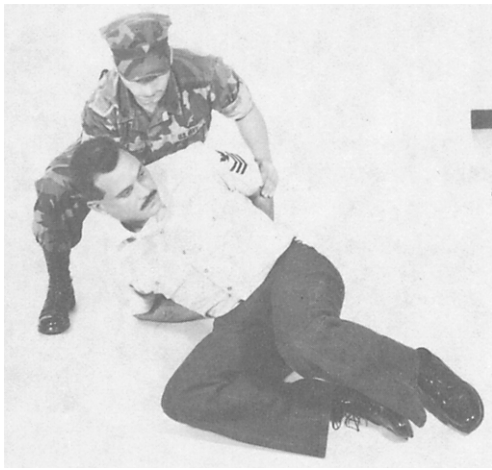

193.275



193.276

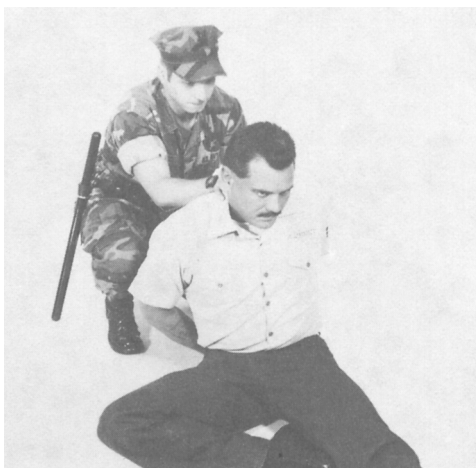

193.277

14. Roll subject over the bent knee into a kneeling position. Order subject to place one foot flat on the ground. Instruct the subject to come to a standing position on the count of three. Count out loud, one . . . two . . . ; on "three," gently push subject between the shoulder blades while ordering him to stand. Re-grasp handcuffs; re-search subject if necessary.

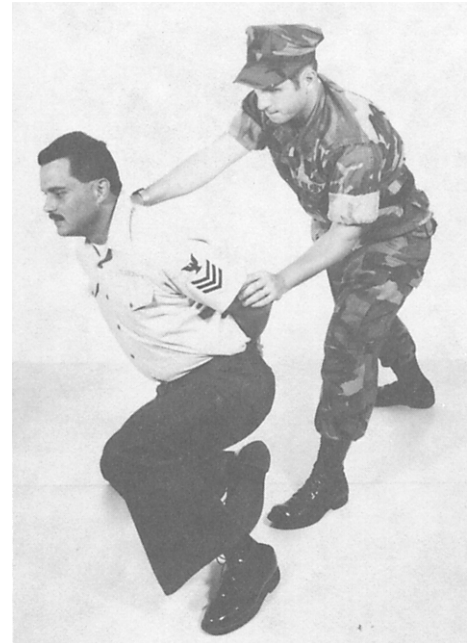

193.278

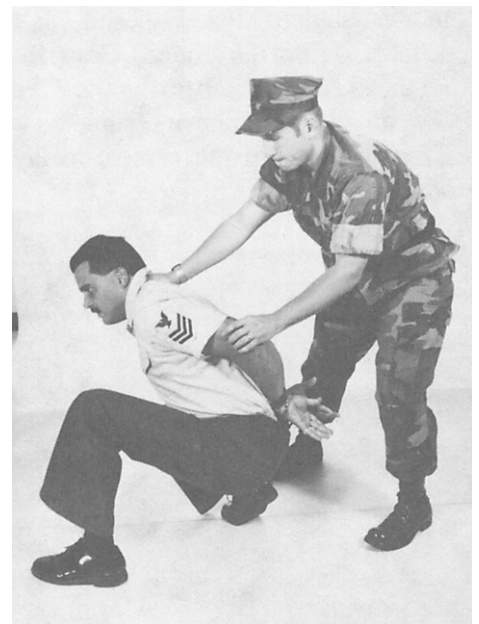

193.279

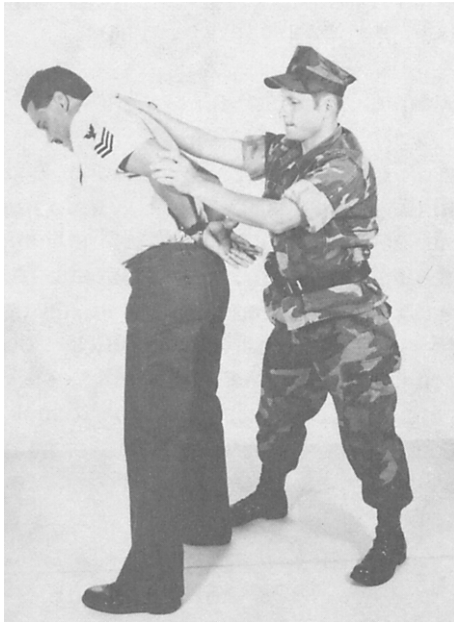

193.280

NOTE

All contraband and weapons taken from subject during any of the above searches should be properly documented and handled as evidence.

Military women offenders are not subjected to a bodily search except by other women of the military service or by female civilian law enforcement officers. A male Master-at-Arms may conduct a patdown search only, which includes a female suspect's handbag, overcoat, or luggage.

COMPLETE SEARCH OF A PERSON

Once an offender is apprehended and taken to headquarters, the person can either be released, restricted in lieu of arrest, or placed in confinement, depending upon the circumstances. The disposition of the offender is determined by the watch supervisor unless disposition instructions are received from higher authority.

In a complete search, an offender is stripped naked and his or her body and clothing are carefully examined. Remember, female offenders must be searched only by other females of the military service or by civilian law enforcement officers. All persons placed in confinement are given complete searches. Complete searches may be conducted in other cases when circumstances justify them. Security violators

who are considered possible saboteurs and suspected narcotics violators are given complete searches. There is always the possibility of well-concealed objects on the body or in the clothing of such persons. A harmless drunk whose condition improves considerably between apprehension and disposition does not require a complete search.

If an offender is confined, the complete search is part of the admission procedure. The prisoner is completely stripped, including watches, rings, and jewelry. The prisoner's body is carefully examined from head to toe. The hair is combed out. All body openings, including mouth, nose, ears, and rectum must be inspected by medical personnel. Every square inch of skin must be examined. Pay particular attention to the areas under the arms, between the toes, and on the soles of the feet. Check bandages and strips of adhesive. If the prisoner is obviously injured, this check can be made by a doctor during the medical examination, which is part of the admission procedures. Most prisoners have no concealed objects on their person, but the few who do justify a complete search. At the completion of the search, all property, including money, is itemized on a property receipt.

VEHICLE SEARCH

A commanding officer may order a search of all vehicles leaving a base, or a search of one specific vehicle. Gate guards, supplemented by additional patrolmen, conduct the search. The object sought may be anything from an escaped prisoner to a piece of electronic equipment. Therefore, the size of the object sought determines the method in which the vehicle is searched.

Simple Search

To search a vehicle for an object such as a stolen toolbox, have the driver open the trunk. Check the trunk, back seat, front seat, under the seats, and any other part of the vehicle that could contain a toolbox. Trucks can be checked by climbing in and looking around. Normally, if an item is so small it could easily be concealed on a person, the vehicle search is not ordered.

Complete Search

A situation that requires a complete search is when an offender is suspected of concealing narcotics in a vehicle. Normally, the Naval Criminal Investigative Service (NCIS) will handle such a case because a

complete search, to be effective, may involve disassembling the vehicle down to the last nut and bolt. In such cases, your only concern is to guard the vehicle until a complete search can be made.

PREMISES SEARCH

Premises may be buildings, barracks, offices, or open areas. As in the case of vehicles, the manner in which a premise is searched depends on the nature and size of the object sought. For example, a stolen television set is far more conspicuous than a stolen diamond ring. Although the techniques for conducting a complete search of a premise may vary, a general inspection of the area or building should always be made first.

General Inspection

The general inspection provides the person or persons conducting the search with better, easier, and more reliable methods for conducting the search. The inspection may include such techniques as checking the physical structure of a building for location, size, number of doors, windows, and fire escapes. This information helps determine the number of persons required for making the complete search. If the search is made to apprehend an offender, the surrounding area

is surveyed for parking lots, streets, or roadways, which could provide avenues of escape.

Complete Search

A complete search may include the searching of buildings, rooms, or areas. Since circumstances vary and objects differ in size, the general rule is to thoroughly examine a particular area to find a particular object. The entire area, whether in the open or in a room, is searched in a clockwise pattern covering the entire area in ever-tightening circles, and is then cross-searched. If sufficient patrol personnel are employed, a sectional search may be made. Normally, this is done by assigning persons to search sections comprising a large area.

SUMMARY

In this chapter, we looked at various patrol activities, patrol organization, methods of patrol, and community/human relations. The importance of accurate communications was discussed followed by the procedures for both unknown and high risk traffic stops. Next, we examined the techniques of apprehension and restraint. Finally, we covered the procedures and techniques for the various types of searches.

CHAPTER 13

MILITARY CUSTOMS INSPECTIONS

The Bureau of Customs, in May 1971, established stringent inspection policies and procedures designed to prohibit the introduction of illegal drugs and other contraband into the United States. These procedures were implemented for use in conjunction with the national antidrug campaign.

Much of the initial effort affecting Department of Defense (DOD) personnel had been concentrated only to the inspection of ships, aircraft, mail, cargo, baggage, household effects and to personnel departing from the Southeast Asia area. However, as the illegal drug problem increased to other parts of the world, it became apparent that the inspection procedures then in existence were ineffective. Accordingly, in February 1973, Customs Inspection Regulation DOD 5030.49-R was enacted. It extended the prohibitive restrictions to all ports of entry into the United States regardless of the foreign point of origin of travel. The combined efforts of the Bureau of Customs and DOD set the theme for the formal establishment of the Military Customs Inspection Program.

Master-at-Arms personnel can expect to be assigned customs inspection duties at some time during their career. Therefore, MAs must know and understand their responsibilities and all applicable laws concerning these duties. The MA must also be aware of the differences in the various laws that govern customs inspections specifically, other related inspections, and search procedures. This is extremely important. For example, if illegal drugs were obtained in an illegal search, they would not be admissible as evidence in a court of law. A major difference in the laws is pointed out in the U.S. Court of Military Appeals decision in the case of *U.S. v. Rivera*, 4 M.J. 215 (CMA 1978) decided 20 Feb 78. Quoted in part:

The U.S. Court of Military Appeals has upheld the validity of random searches of personnel entering American military installations and enclaves from foreign soil so long as the searches are conducted at the entry point and are limited in scope. In the case of *United States v. Rivera*, 4 M.J. 215 (CMA 1978), the court likened such searches to those conducted at international borders and, as such, not requiring a warrant or probable cause.

Although *Rivera* dealt with a base in Thailand, it maybe read as applicable to all overseas bases and to ships when outside the United States. The scope of the searches authorized under *Rivera* is limited to an external search of the suspect and his clothing, the articles carried by him, vehicles and contents of vehicles. Detection dogs may be used to assist in these searches.

If the requirements of *Rivera* are complied with, contraband seized pursuant to these searches is admissible in subsequent prosecutions.

This expanded search authority should be considered as applicable only to personnel returning from foreign soil and should be conducted immediately upon the individual's return to the base/ship.

Specific forms mentioned but not illustrated in this chapter may be found in DOD regulation 5030.49-R. Forms are obtained through normal publication supply channels in accordance with the *Navy Stock List of Publications and Forms*, (NAVSUP 2002).

GENERAL PROVISIONS OF MILITARY CUSTOMS INSPECTIONS

LEARNING OBJECTIVES: Identify the regulation that covers the DOD Military Customs Inspection Program, and list the commands and organizations to which it applies. State the policy of the DOD Military Customs Inspection Program and identify the executive agent. Explain the responsibilities of the unified and specified commands.

DOD 5030.49-R establishes policy, prescribes procedures, defines responsibilities, and outlines customs and certain agricultural inspection and entry requirements to eliminate the introduction of narcotics, drugs, and other contraband into the United States through DOD channels. DOD 5030.49-R is applicable to the Office of the Secretary of Defense, the organization of the Joint Chiefs of Staff, the military departments, the unified and specified commands and DOD components. This regulation also applies to

non-DOD agencies and organizations that use DOD mail and transportation facilities.

POLICY

It is the policy of the DOD to

- eliminate the flow of narcotics, drugs, and other contraband into the United States through all DOD channels, including the Defense Transportation System and Military Postal Service channels;
- prevent the illegal entry of aliens into the United States via DOD-sponsored or -directed travel;
- cooperate fully with, and assist all other Government agencies in enforcing the laws and regulations of the United States concerning Customs, Agricultural, and Immigration border clearances; and
- minimize inconvenience to DOD personnel and delays in the movement of DOD cargo and mail caused by the enforcement of U.S. border clearance regulations.

MILITARY CUSTOMS INSPECTION PROGRAM

The Department of the Army is assigned executive agent responsibility for customs inspection activities in DOD.

The commanders of unified and specified commands are responsible for designating, in writing, military customs inspectors (MCIs) and ensuring that such personnel are properly trained and of unquestionable character. These commanders are also responsible for establishing quality control procedures to ensure the effectiveness of the DOD Military Customs Inspection Program, including appropriate action when military customs personnel fail to perform their assigned duties.

RESPONSIBILITIES OF THE MILITARY CUSTOMS INSPECTOR

LEARNING OBJECTIVES: Identify who may serve as military customs inspectors. Explain the procedures for passengers and accompanied baggage, unit moves, DOD-sponsored cargo, official and personal mail, ships and aircraft, personal property, and firearms and ammunition.

Military customs inspectors may be commissioned officers, warrant officers, enlisted personnel with the

rank of E-4 or above, enlisted security or military police personnel, regardless of who who have satisfactorily completed a U.S. Customs-approved training course and work under direct supervision of a non-commissioned officer, and Department of Defense civilian employees who are citizens of the United States with GS-5 or above grade.

A waiver may be granted for appointment of enlisted personnel below the grade of E5 by the unified or specified commander.

MCIs do NOT-under any circumstances-accept cash duty payments. They are responsible for

- performing their duties under DOD 5030.49-R and other implementing regulations;
- representing their commanders in conducting inspections/examinations, and ensuring that the documentation for which they are responsible accompanies all shipments; and
- ensuring that violations not within their scope of responsibilities under DOD 5030.49-R are expeditiously reported to USCS, USDA, or INS, as appropriate, as well as to the appropriate military agency for disposition.

PASSENGERS AND ACCOMPANIED BAGGAGE

All passengers, crewmembers, accompanied baggage, and equipment boarding any DOD-sponsored ship or aircraft departing an overseas area for the Customs territory of the United States (CTUS) must be inspected or examined prior to departure. The MCI should accomplish this inspection or examination immediately before departure of the ship or aircraft. However, since military aircraft embarked on a naval vessel normally fly to military air stations in the CTUS in advance of the ship's arrival, they require the special notification and coordination procedures as specified in applicable service regulations.

The purpose of this inspection or examination is to detect articles that are prohibited entry into the CTUS or that are admissible only under certain conditions. An effective overseas inspection or examination will expedite clearance by U.S. border clearance officials at the CTUS port of entry.

MCIs should inspect or examine aeromedical evacuation crews, attendants, and patients in such a manner as to expedite patient movement. However, expeditious inspection or examination by the MCI does

not preclude taking the steps necessary to detect prohibited articles prior to departure.

Predeparture Inspection/Examination Procedures

Inspections should be conducted to preclude the entry of prohibited and restricted articles, with particular attention to drugs and narcotics, firearms, and plant and animal products, and undeclared dutiable articles.

An *inspection* is defined as the detailed observation of personal property, and DOD cargo or other equipment, noting their markings and outer physical characteristics. Inspection of personnel involves observation and/or oral questioning to determine the potential for customs violations.

An *examination* is defined as the process of scrutinizing personal property, and DOD cargo or other equipment, which includes the physical opening of baggage, parcels, cartons, and containers, the disassembly of articles, as required, and ascertaining their contents. Once the property, cargo, or equipment is opened, the depth or degree of examination is left to the discretion or judgment of the MCI. Examination of personnel involves the physical search for contraband.

Before the inspection or examination begins, MCIs should make sure that all passengers and crewmembers are briefed or provided information on their responsibilities. They should also be provided clarifying explanations of exemptions, restrictions, and prohibitions indicated on the custom declaration form, U.S. Customs Accompanied Baggage Declaration, DD Form 1854. See figure 13-1.

Passengers should be given ample opportunity to declare or dispose of all dutiable, prohibited, and restricted articles in their baggage or immediate physical possession. An amnesty box is made available to all passengers and crewmembers for deposit of prohibited or nonadmissible articles prior to inspection or examination. The amnesty box should not be located in a place that is visible to inspecting officials.

All passengers and crewmembers and their accompanied baggage and/or professional equipment bound for the CTUS must undergo a predeparture customs inspection; an examination is usually not required. The degree to which passengers and crewmembers and their accompanied baggage/professional equipment are to be inspected or examined is to be left to the discretion of oversea commanders and military customs officials. Examination of personnel is

undertaken only when there is probable cause that contraband may be concealed on the suspect's person and with specific approval of the senior MCI present at the inspection activity.

In all cases where an examination is conducted the dignity and privacy of the individual should be preserved (a curtained booth or closed room may be used). No force should be applied and no harsh language should be used. In the case of persistent refusal by a military member to being examined the assistance of law enforcement personnel must be obtained before proceeding with the examination.

Inspection or examination of civilians is not conducted over their objection. Should these personnel refuse to submit to an inspection or examination, they are denied access to the DOD-controlled ship or aircraft. They are provided transportation by other practicable means under the provisions of appropriate directives, and U.S. Customs representatives at the first port of entry are notified.

All accompanied baggage is inspected or examined in the passenger's or crewmember's presence. Such baggage is made available for inspection or examination by each passenger or crewmember-with the exception of patients, whose baggage is made available by the medical attendant. Once the baggage has been inspected or examined, it will be kept isolated in a sterile area until departure. Normally passengers and crews are not allowed access to their baggage once it has been inspected or examined by the MCIs. In an emergency, the passengers may regain access to their baggage, but it must then be re-inspected or re-examined completely.

If, while inspecting or examining a passenger or the passenger's baggage, an MCI suspects that a customs violation has occurred, the MCI should call for the assistance of appropriate military enforcement officials. These officials will accept responsibility for the individual and any contraband, and will advise the individual regarding their rights prior to further questioning.

Customs Declaration Procedures

All personnel, including military crewmembers, with accompanied baggage must complete US Customs Accompanied Baggage Declaration, DD Form 1854 (fig. 13-1), upon inspection or examination. Civilian crewmembers must complete Customs Form 5129.

All patients aboard aeromedical evacuation flights must also prepare a DD Form 1854. Patients who are

US CUSTOMS ACCOMPANIED BAGGAGE DECLARATION						
DATA REQUIRED BY THE PRIVACY ACT OF 1974						
<p>AUTHORITY: 19 U. S. C. 1498</p> <p>PRINCIPAL PURPOSE: To declare shipments of household goods, unaccompanied baggage, and privately owned vehicles for which free entry is claimed. Section A. Owner custom declaration for type of shipment and reason for shipment. Section B - Military Customs Inspector certifies that property has been inspected/examined and provides customs inspector's stamp.</p> <p>ROUTINE USES: (1) Use of your Social Security Number is proof of identification that person processing through Customs is not an importer and also assist in criminal prosecution if contraband or undeclared articles, for which Customs fees are due, are found in shipment. (2) Origin transportation officer and military customs inspector retain copies as proof that shipment has been properly processed. Copies are destroyed when no longer required.</p> <p>DISCLOSURE: DISCLOSURE OF YOUR SSN IS VOLUNTARY. HOWEVER, FAILURE TO PROVIDE YOUR SSN AND OTHER REQUESTED PERSONAL INFORMATION MAY CAUSE DELAY IN PROCESSING THROUGH CUSTOMS, PENDING POSITIVE IDENTIFICATION.</p>						
1. FLIGHT NUMBER OR VESSEL NAME		2. PLACE OF ARRIVAL U.S.		4. NO OF PIECES OF BAGGAGE		
		3. DATE OF ARRIVAL (Day, Month, Year)		CHECKED		
				HANDCARRIED		
				TOTAL		
5. NAME (Last first middle initial)		6. GRADE/RANK		7. SOCIAL SECURITY NUMBER		
8. UNIT ADDRESS OVERSEAS (Include APO number) Address OUTSIDE the Customs Territory of the U. S. (CTUS). Complete only if you are on leave or on TDY in CTUS.		9. ADDRESS IN U.S. (Include ZIP Code) Home or temporary address if you are on leave or TDY in CTUS.				
10. PERSONS ON THIS DECLARATION (Check applicable boxes) <input type="checkbox"/> MILITARY <input type="checkbox"/> MILITARY DEPENDENTS <input type="checkbox"/> CIVILIAN <input type="checkbox"/> CREWMEMBER		11. TOTAL NUMBER OF PERSONS COVERED BY DECLARATION				
STATUS FOR RETURN (Check one box in either A or B)						
<p>A. EXTENDED DUTY PCS PERSONNEL AND OTHERS ENTITLED TO PL 89-406</p> <input type="checkbox"/> COMPLETED ASSIGNMENT - 140 DAYS OR MORE <input type="checkbox"/> COMPLETED ASSIGNMENT - LESS 140 DAYS <input type="checkbox"/> OTHER <small>Complete items 12, 15 and 16 only. See instruction 1 on reverse before completing item 15. Also a copy of your orders.</small>			<p>B. LEAVE, TDY AND TOURIST PERSONNEL ONLY</p> <input type="checkbox"/> LEAVE on leave in CTUS. (Check applicable box) <input type="checkbox"/> TDY on TDY in CTUS. <input type="checkbox"/> TOURIST <small>Complete items 14, 15 and 16 only. See instructions 3 and 4 on reverse before completing item 15.</small>			
13. DATE OVERSEAS TOUR WHICH I AM NOW COMPLETING BEGAN LEAVE BLANK			14. DATE OF LAST EXEMPTION UPON ENTERING THE UNITED STATES FROM A FOREIGN COUNTRY (Day, Month, Year) Date of last exemption at U. S. Customs.			
15. COMPLETED BY DECLARANT			16. FOR CUSTOMS USE ONLY			
DESCRIPTION OF ARTICLES (See instruction 2, 3 or 4 on reverse)		VALUE OR COST	TARIFF DESCRIPTION	RATE	DUTY	IR TAX
DECLARE all articles obtained OUTSIDE CTUS that will be left in CTUS.						
DO NOT DECLARE items that you obtained in CTUS, military gear, or goods of U.S.						
INFORM the Military Customs Inspector (MCI) and the U. S. Customs Inspector						
If you are bringing in items as an accomodation for others (Merchandise requested by a person in CTUS, or something a person outside CTUS asked you to deliver).						
DO NOT DECLARE items that you intend to take back outside CTUS on completion of leave or TDY.						
THIS DECLARATION APPLIES TO: 1.		MILITARY CREWS STATIONED OUTSIDE CTUS ON SHORT ASSIGNMENT OR LEAVE IN CTUS.				
2.		ALL OTHER MILITARY PERSONNEL OR GOVERNMENT EMPLOYEES ON SHORT ASSIGNMENT OR LEAVE IN CTUS.				
3.		MILITARY AND DOD CIVILIAN DEPENDENTS ON LEAVE IN CTUS AND SCHEDULED TO RETURN ABROAD.				
4.		ALL OTHERS ON LEAVE OR SHORT STAY IN CTUS AND SCHEDULED TO RETURN ABROAD.				
TOTAL VALUE		GENERALLY, THESE ARE NON-RESIDENT.		TOTAL		
16. ARE YOU OR ANYONE IN YOUR PARTY CARRYING OVER \$5000.00 IN CURRENCY, OR MONETARY INSTRUMENTS? <input type="checkbox"/> YES <input type="checkbox"/> NO			19. DUTY COLLECTED \$			
			20. INTERNAL REVENUE TAX COLLECTED \$			
17. DECLARATION: I declare that the above list of items includes all items which I(we) have acquired abroad and is in my possession.			21. TOTAL DUTY AND IR TAX COLLECTED \$			
SIGNATURE OF DECLARANT AND DATE			22. CUSTOMS RECEIPT (CF 5104) NUMBER			
			23. CUSTOMS INSPECTOR'S SIGNATURE AND DATE			

DD FORM 1854
APR 77

REPLACES EDITION OF 1 OCT 72, WHICH IS OBSOLETE.

Figure 13-1.—US Customs Accompanied Baggage Declaration, DD Form 1854.

physically unable will have the form prepared for them by the medical attendant.

Duty-free Entry Limitations

Military and civilian employees of the U.S. Government and their accompanying dependents returning to the CTUS on PCS orders are authorized duty-free entry into the CTUS of all personal and household effects. However, the effects must have been in their direct personal possession while overseas subject to the limitations outlined in DOD 5030.49-R.

An individual on leave or TDY returning to the CTUS for a short visit or limited assignment from an overseas extended duty station may enter as a "nonresident." As such, the individual may import free of duty, personal effects for one's own use while traveling (for example, wearing apparel, toilet articles), and not intended for sale, or gift, and other items as listed in DOD 5030.49-R.

An individual on leave or TDY who is returning to the CTUS but not from an overseas extended duty station may also enter as a "returning resident."

An individual entering the CTUS as a "returning resident" may import duty-free personal and household use articles, provided that the total value of all such articles does not exceed those limits outlined in DOD 5030.49-R.

Each passenger and crewmember must list on his or her declaration the price actually paid for dutiable articles acquired overseas or the estimated fair retail value of the articles acquired as gifts.

All articles imported in the CTUS are subject to customs duty unless specifically exempted by tariff laws. There is no provision under U.S. law for the collection of duties or taxes until the merchandise has been imported. Accordingly, MCIs will not assess or collect duties or taxes. If duties are due, a U.S. Customs officer will compute the amount of duty to be paid from the customs declaration when the passenger or crewmember arrives at the U.S. port of entry.

Immediately prior to baggage inspection or examination, the declaration of each passenger and crewmember must be checked for completeness. MCIs will assist passengers by clarifying the reverse side of the declaration when necessary.

Upon completion of the baggage inspection or examination, the MCI will stamp the face of the DD Form 1854 with the Customs Inspector stamp under the last item listed or at the top line if no items are listed.

The signature of the MCI will then be affixed to the form and the form returned to the individual for presentation to the U.S. Customs Service official at the U.S. port of entry.

When an undeclared restricted article is found in a member's accompanied baggage or professional equipment and is not removed, the MCI draws a diagonal red line across the face of the DD Form 1854 to call its attention to U.S. Customs or U.S. Department of Agriculture officials at the port of entry in the U.S. The MCI advises the member that the DD 1854 has been redlined and the reason therefor.

Personnel who have completed customs processing are required to proceed directly to the sterile area without delay.

UNIT MOVES

During unit moves, all baggage, passengers, and equipment are inspected or examined, as appropriate. After inspection or examination, all baggage, passengers, and equipment are held in a sterile area until embarked.

Predeparture Inspection

Predeparture inspection is one that satisfies the requirements of the U.S. Customs Service prior to departure. The requirements of the Department of Agriculture are then accomplished upon arrival at CONUS.

Normally, for unit moves, accompanied baggage in excess to immediate personal needs are inspected/examined in the presence of a member of an MCI team 1 or 2 days before the unit departure. The baggage remains secured from the time of inspection or examination until its arrival at the U.S. port of entry.

Hand or cabin baggage is inspected or examined by a MCI team at the time passengers are processed into a sterile area for isolation until actual departure.

Declarations will be accomplished as previously explained.

Preclearance

Preclearance means that the entry requirements of the U.S. Customs Service and the Department of Agriculture have been met prior to departure.

Units may, upon approval, be given a preclearance at the overseas departure point. Preclearance inspections are more extensive than predeparture inspections and normally are accomplished under the technical supervision of U.S. Customs and U.S. Department of Agriculture Advisors or border clearance agency officials.

DOD-SPONSORED CARGO

U.S. Federal regulations provide that all Government imports are subject to inspection and/or examination and entry requirements. The cargo must be declared to the customs officer at the first port of entry and be available for any appropriate border clearance inspection.

Inspection/Examination Procedures

Except as stated below, all DOD-sponsored cargo is inspected or examined, as appropriate, within the overseas area, preferably at the point of origin, prior to shipment to the CTUS.

This inspection/examination is conducted by MCI personnel, and can only be waived in those instances where the inspection or examination is impracticable or uneconomical. Specific inspection procedures are as follows:

Prior to unit moves, all military equipment to be entered into the CTUS must be inspected as deemed appropriate by commanders and/or MCIs. Military equipment must be inspected or examined at the time it

is placed in boxes, crates, containers, sea vans, or similar receptacles for shipment. It is then secured until departure from the overseas area. Vehicles and similar items that will be shipped essentially in as-is condition are inspected or examined and secured immediately prior to loading on the aircraft or vessel on which they will depart the overseas area.

Human remains and transfer cases returned to the CTUS for interment are examined at the point of origin by an MCI in conjunction with, or following, required mortuary inspections. The examination includes the interior of cases and is conducted prior to closure and sealing of the outer container shipping case.

Closed loop and special repair activity repairable spare parts and similar items for which the destination in the CTUS is predetermined are inspected at the point of origin. The inspection or examination is conducted when the shipment is assembled, crated, containerized, or otherwise prepared for shipment.

When items are returned to the CTUS from depot or other stocks, and destination of such items is not determined until time of shipment, inspection or examination overseas is not required. However, officers in charge of facilities consolidating such items into other crates, containers, or similar cargo transporters will establish procedures to preclude the introduction of contraband.

Immediately upon completion of the inspection, Military Customs Inspection (Label), DD Form 1253 (fig. 13-2) or Military Customs Inspection (Tag), DD Form 1253-1 (fig. 13-3), as appropriate, is completed and authenticated by official stamp and signature and is securely affixed to the outside of each container of

The form is titled "MILITARY CUSTOMS INSPECTION (LABEL)". It contains the following fields:

- SPONSORING SERVICE
- PKG NO
- NO OF PKGS
- PERSONAL PROPERTY
- US GOVERNMENT PROPERTY
- INSPECTED
- EXAMINED
- NAME OF INSPECTOR (Last, First, MI) (Type in print)
- GRADE
- MILITARY CUSTOMS INSPECTOR STAMP (large empty box)
- DATE

 At the bottom left, it says "DD FORM 1 APR 77 1253" and at the bottom center, "REPLACES EDITION OF 1 DEC 72 WHICH IS OBSOLETE".

Figure 13-2.-Military Customs Inspection (Label), DD Form 1253.

The form is titled "MILITARY CUSTOMS INSPECTION (TAG)". It contains the following fields:

- SPONSORING SERVICE
- PKG NO
- NO OF PKGS
- PERSONAL PROPERTY
- U.S. GOVERNMENT PROPERTY
- INSPECTED
- EXAMINED
- NAME OF INSPECTOR (Last, First, MI) (Type in print)
- GRADE
- DATE

 On the left side, it says "DD FORM 1253-1 1 APR 77". At the bottom, it says "USE REVERSE SIDE FOR MILITARY CUSTOMS INSPECTOR STAMP".

Figure 13-3.-Military Customs Inspection (Tag), DD Form 1253-1.

articles inspected or examined. Completion and attachment of the label or tag is accomplished by the MCI.

All DOD-sponsored cargo entering the CTUS will be subject to re-inspection/re-examination by U.S. Customs and/or Agriculture officials at the first port of entry. This is a spot check for validating procedures and standards of the military customs inspection program. The degree of re-inspection is the sole prerogative of the border clearance officials. All shipments considered suspect by either the MCI (so noted by redlining the DD Form 1252, 1253-1, and 1253 as required) or the U.S. border clearance officials will be re-inspected/re-examined. When redlining a customs form, draw a 1/4" red line from the lower left corner to the upper right corner of the document.

Entry Procedures

Operators of air and ocean terminals within the CTUS establish coordination with the District Director of Customs responsible for their area. They prepare and provide customs documentation when required.

OFFICIAL AND PERSONAL MAIL

The procedures outlined here do not apply to matter mailed from the CTUS to military post offices outside the CTUS, or from one overseas military post office to another overseas military post office. Procedures for the prevention of the trafficking of contraband in these channels are covered in appropriate Navy, unified command, and U.S. Postal Service regulations.

Official Mail

Heads of DOD component activities are responsible for ensuring that official mail is free of contraband.

Commanders at all levels must review their procedures to ensure that stringent controls are implemented to prevent the use of official mail for the mailing of contraband.

Official mail is accepted at military post offices only from individuals recognized as authorized agents or unit mail clerks. Mail other than ordinary letters entered into a military post office, will be returned to the origin activity or organization for verification of its authenticity.

Official mail transmitted between military post offices and the CTUS requires no customs declaration forms or additional endorsements. Official matter mailed with postage affixed will not bear customs declaration forms but will be endorsed "Contents for Official Use-Exempt from Customs Requirement." Personal property entered as official mail will be documented as outlined in the personal property section of this chapter.

All official mail entered into the military postal system by authorized non-DOD agencies suspected of containing contraband is forwarded under an indicia label to the appropriate U.S. Customs Service activity in the CTUS for examination, provided it is addressed to a point in the CTUS.

Personal Mail

Commanders normally establish continuing information programs to discourage and deter mailing of narcotics, drugs, and other contraband. They also review current procedures to ensure that effective controls are in effect to prevent such use of personal mail.

All parcel mail addressed to the CTUS is routed to U.S. Customs facilities at ports of entry as mail liable to customs inspection or duty.

Customs Declaration Procedures

Parcels containing merchandise mailed as personal mail from overseas military post offices to points within the CTUS are subject to customs examination. Customs duty and/or revenue tax (hereafter referred to simply as duty) may be imposed unless duty-free entry is provided by law.

Letter mail containing merchandise, parcels containing merchandise subject to duty, all film mailers, all voice tape cassettes, and all gift parcels mailed at military post offices outside the CTUS and addressed to points within the CTUS must be accompanied by an authorized customs declaration form. Declaration forms will be legibly completed in ink or by typewriter. The mailer assumes all responsibility for accuracy of the information entered on the form.

Letters containing merchandise, and parcels mailed as first-class should bear a properly completed Customs Declaration to Open International Mail Label, PS Form

CUSTOMS—DOUANE C 1
May be Officially Opened
(Peut Otre ouvert d'office)

SEE INSTRUCTIONS ON BACK

Contents in detail:
Désignation détaillée
du contenu: _____

Mark X here if a gift
Il s'agit d'un cadeau
or a sample of merchandise
d'un échantillon de marchandises

Value: _____ Weight: _____
Valeur _____ Poids _____

PS Form 2976
July 1971

INSTRUCTIONS

Affix only the upper portion of this label (cut on dotted line and discard lower portion) if you do not wish to list the contents on the wrapper, or in any case if their value exceeds \$100. When this is done, enclose in the package a completed separate declaration (Form 2976-A) listing contents and value.

The contents of your article, even if a gift or sample, must be described correctly and completely. Failure to do so might delay your article and cause difficulty for the addressee, or even result in seizure of the article by the foreign customs authorities.

**LABEL IS GUMMED
MOISTEN AND APPLY**

★ 870-871-0-480-784

Figure 13-4.-Customs Declaration to Open International Mail, PS Form 2976.

2976 (fig. 13-4) on the address side of the article. Should the sender prefer not to show the nature of the contents on the outside of the first-class article, only the upper part of the form need be affixed on the outside. Customs Declaration, PS Form 2976-A (fig. 13-5) may be enclosed in the letter or parcel.

Parcel post (surface or airmail) and third-class surface parcels should have a properly completed Customs Declaration (Parcel Post) Tag, PS Form 2966 (fig. 13-6) or Parcel Post Customs Declaration Form, PS Form 2966A (fig. 13-7) affixed to the address side of the parcel so that the declaration lies

UNITED STATES OF AMERICA Etats-Unis d'Amérique		CUSTOMS DECLARATION Déclaration en Douane			
BEFORE COMPLETING, READ INSTRUCTIONS ON THE BACK	SENDER'S NAME AND ADDRESS Nom et adresse de l'expéditeur		SENDER'S REFERENCE NUMBER Eventuellement numero de référence de l'expéditeur		
	ADDRESSEE'S NAME AND ADDRESS Nom et adresse du destinataire		MARK X HERE IF A Il s'agit d'un <input type="checkbox"/> GIFT <input type="checkbox"/> SAMPLE OF MERCHANDISE <input type="checkbox"/> Cadeau <input type="checkbox"/> Echantillon de marchandises 		
			UNDERSIGNED DECLARES THAT THE STATEMENTS HEREIN ARE CORRECT		
	OBSERVATIONS		PLACE AND DATE Lieu et Date		
SIGNATURE					
		COUNTRY OF ORIGIN OF MERCHANDISE Pays d'origine des marchandises	COUNTRY OF DESTINATION Pays de destination		
		TOTAL GROSS WEIGHT Poids brut total			
CONTENTS IN DETAIL Désignation détaillée du contenu		TARIFF NO (if known)	NET WEIGHT Poids Net		VALUE Valeur
			LBS	OZ	

PS Form 2976-A
Jul 1971

Figure 13-5.-Customs Declaration, PS Form 2976-A.

POD Form 2966
Feb. 1966

UNITED STATES OF AMERICA
PARCEL POST
CUSTOMS DECLARATION

QUANTITY	USE INK OR TYPEWRITER ITEMIZED LIST OF CONTENTS	VALUE	
		\$	Cents

Insured No. _____ Insured for—\$ (U. S.) _____

Gross Weight (Parcel) _____ lb. _____ oz. (Date Stamp of Mailing Office) _____

INSTRUCTIONS GIVEN BY SENDER
Dispositions de l'expéditeur

Sender must check alternative disposition desired.
IF UNDELIVERABLE AS ADDRESSED:
Au cas de non-livraison, le colis doit être:

Return to sender. Return charges guaranteed.
Remoyé à l'expéditeur, qui s'engage à payer les frais de retour.

Forward to: *Réexpédié à M.:*

Abandon. *Abandonné.*

(City, State—Ville, Province, Département)

(Address of sender—Adresse de l'expéditeur)

(City, Province, State, etc.—Ville, Province, Département, etc.)

(Country—Pays)

(Sender must comply with U. S. export control regulations.)

TO

(Name of addressee—Nom du destinataire)

(Street and number—Rue et numéro)

(City, Province, State, etc.—Ville, Province, Département, etc.)

Figure 13-6.-Customs Declaration (Parcel Post), PS Form 2966.

PARCEL POST CUSTOMS DECLARATION — UNITED STATES OF AMERICA

INSTRUCTIONS GIVEN BY SENDER
Dispositions de l'Expéditeur

If undeliverable as addressed:
Au cas de non-livraison:

Return to sender. Return charges guaranteed.
Le colis doit être renvoyé à l'expéditeur, qui s'engage à payer les frais de retour.

Forward to. (Le colis doit être réexpédié à):

Abandon. (*Abandon du colis.*)

(Sender's Signature—Signature de l'expéditeur)

QTY	USE INK OR TYPEWRITER ITEMIZED LIST OF CONTENTS	VALUE (U.S. \$)

MAILING OFFICE DATE _____ LBS. _____

STAMP _____ OZS. _____

POSTAGE \$ _____

ACCEPTING CLERK'S INITIALS _____

INSURED VALUE (U.S. \$) _____

PS Form 2966-A, June 1972

THIS LABEL FOR INTERNATIONAL PARCEL POST USE. COMPLETE AND APPLY ON ADDRESS SIDE OF PARCEL. SEND AT SUIIT AND FEE OFF BACKING.

Figure 13-7.-Parcel Post Customs Declaration, PS Form 2966-A.

flat on the parcel with the "List of Contents" side face up.

Customs declaration forms should be completed in detail with contents descriptively listed and valued by the mailer.

Bona Fide Gifts

Any person in the CTUS may receive, duty-free, unsolicited gifts through the mails from persons in foreign countries in accordance with the limitations outlined in DOD 5030.49-R.

Personal Property

Personal property acquired overseas while on extended duty may be imported into the CTUS duty-free and may be mailed. The address side of parcels containing such items is endorsed "Free Entry Claimed Under Public Law 89-436, Movement Order Enclosed," or similar wording. A copy of appropriate PCS orders should be enclosed in the parcel or in an envelope marked "Orders Enclosed" attached thereto.

Former Government Property

Parcels containing legally acquired items of former Government property, with properly completed customs forms attached, should be mailed with a copy of a sales slip or other evidence of personal ownership. This is necessary to preclude confiscation and return of the items to Government control.

SHIPS AND AIRCRAFT

Any DOD component that operates, sponsors, or provides terminal services to a ship or aircraft arriving in the CTUS from outside the CTUS is responsible for notifying the appropriate U.S. Customs office of the ship's or aircraft's departure point and expected arrival time at the U.S. port of entry. The DOD component coordinates the arrangements to obtain border clearances and provides assistance to the U.S. Customs Service, Department of Agriculture, and other border clearance agencies, as required.

Military departments that operate ships and aircraft arriving into the CTUS from overseas must comply with the provisions of DOD 5030.49-R and other agreements between DOD and U.S. Customs Service, or other appropriate Federal agencies.

The ship or aircraft commander provides customs documentation to boarding U.S. Customs and Agriculture officials upon arrival at the first berthing or landing within the CTUS. The ship or aircraft commander will not permit any cargo, baggage, or equipment to be removed from the landing place

without permission from the designated customs official. Additionally, the commander should not allow any passenger or crewmember to depart from the landing place prior to completion of the customs inspection. Removal of cargo and/or departure of personnel may be allowed only for the safety or preservation of life or property.

Ships

All ships entering the CTUS will have undergone, prior to arrival at the first U.S. port of entry, a complete military customs inspection. Such inspection is performed to preclude illegal entry of contraband into the CTUS and to ensure that all personnel on board are properly declared for border clearance purposes.

The commanding officer of a ship is responsible for presenting a manifest of all cargo loaded aboard the ship in foreign ports for discharge in the CTUS to U.S. Customs officials at the first U.S. port of entry. His manifest is also presented to the military ocean terminal operator.

When the crew and vessel—but not cargo—are cleared at the first U.S. port of entry, the commanding officer will notify U.S. Customs at subsequent ports of entry of cargo on board for discharge, and present a cargo manifest.

INSPECTION REQUIREMENTS.— The commanding officer of a ship entering the CTUS is responsible for ensuring that a complete customs inspection has been accomplished prior to arrival at the U.S. port of entry.

The inspection of the ship is conducted to preclude the use of the ship, its cargo and equipment, or the personnel on board, for the illegal introduction of drugs, narcotics, and other contraband into the CTUS.

The inspection should be accomplished between the last port-of-call before entry into the CTUS while underway.

A customs inspection plan should be prepared for each ship operating outside the CTUS. The plan is developed to outline those procedures to be followed in ensuring the conduct of an effective inspection. The plan includes procedures, both for inspecting the ship and its cargo and personnel, and for completion and collection of personal declarations.

INSPECTION PROCEDURES.— Inspections are normally performed by trained and designated MCIs, who are either from shore-based activities or are assigned to the ship. Each military-operated ship normally maintains at least one MCI within its crew, ideally the

MA on board. In those instances where MCI training is not available or where crew size makes the inspection impractical, this requirement may be waived by the unified/specified commander to which the ship is assigned. When an MCI capability does not exist, the commander of the ship appoints an officer to conduct the inspection.

Specific areas to be inspected will include, at the minimum,

- ship spaces, such as lockers, boats, cargo holds, living areas, and embarked aircraft;
- cargo and equipment on board, including organic equipment of units embarked; and
- postal facilities, including post offices, postal equipment, stowage areas, and drop boxes.

All personnel on board and their baggage should be inspected. This includes passengers, crewmembers, security personnel, observers, and civilian technicians. Inspection of personnel will be conducted as stated earlier in this chapter. As part of the customs inspection and in preparation for clearance at the U.S. port, all personnel must complete a personal declaration, DD Form 1854.

Contraband seized during inspections prior to departure from the overseas port is turned over to the appropriate shore-based U.S. military law-enforcement agency, if available. Contraband seized during inspections while underway is turned over to the U.S. Customs officials at the U.S. port of entry.

CLEARANCE.— Ships normally arrive at U.S. ports of entry that are well established and have border clearance officials readily available. Clearances are expedited by these officials by virtue of the military customs inspection. Re-inspection is the prerogative of clearance officials.

All personnel must have all dutiable, prohibited, and restricted items available for inspection by U.S. Customs and U.S. Department of Agriculture clearance officials.

Clearance officials are briefed on procedures used in the customs inspection of the ship and on the qualifications of personnel who conduct the inspection.

The commanding officer of the ship provides written certification that a customs inspections has been completed to the clearance officials. Figure 13-8 is an example of the cover letter to U.S. Customs that accompanies the declaration prior to clearing customs inspection.

	_____ (Date)
From: Commanding Officer, USS Neversail (CVN-1)	
To: District Director of Customs 101 East Main Street Norfolk, Virginia 23510	
Attn: Supervisory Customs Inspector Norfolk International Terminals	
1. Date ship departed CONUS:	
2. Ports of Call:	
a.	
b.	
c.	
d.	
3. Last foreign port and date of departure.	
4. Date of return to CONUS.	
5. Total personnel on board.	
_____ (Military)	_____ (Civilian)
6. Dates of searches for contraband or drugs.	
7. Give list of contraband found.	
8. Also give names of personnel connected with contraband or suspects, if any. Show disposition of contraband, i.e., tossed over side, incinerated, held pending court action, turned over to NCIS.	
9. State whether any foreign purchases for ships store remain on board.	
10. State whether vessel is carrying any cargo or items as an accommodation for others. (If cargo is carried, provide a Manifest).	
_____ (Commanding Officer)	

Figure 13-8.—Cover letter to U.S. Customs.

Aircraft

All aircraft departing overseas areas for destinations with the CTUS must undergo a predeparture customs inspection. These aircraft are formally cleared and are subject to re-inspection by U.S. Customs and Agriculture officials at the U.S. port of entry.

Unified and specified commanders are responsible for ensuring that all aircraft departing their area are inspected by properly designated MCI personnel to prevent the trafficking of drugs, narcotics, controlled substances, and other contraband.

SPECIAL PROCEDURES.— Aircraft departing from a point outside the CTUS with less than 3 hours' flight time from the point of entry into the CTUS will pass notification to the U.S. port of entry by radio as soon as practical after takeoff.

As stated earlier, Navy aircraft embarked on aircraft carriers that fly to naval air stations in the CTUS in advance of the carrier's arrival require special notification and coordination procedures.

Military aircraft based in the United States that transport, as their primary mission, high-level U.S. Government officials and employ on-board security personnel may be exempted from the requirement for a predeparture inspection when carrying code 1, code 2, or code 3 passengers. These exemptions and codes are contained in *FAA Flight Service Interphone Communication System Procedure*, OPNAVINST 3722.8. This provision in no way exempts such aircraft from inspection by U.S. Customs at U.S. ports of entry, or from foreign country customs/border clearance requirements.

UNSCHEDULED LANDINGS.— When an aircraft makes an unscheduled landing, as in an emergency, at an airport where a border clearance cannot be immediately obtained, the aircraft commander ensures that no cargo, baggage, or equipment is removed from the aircraft. No passengers or crewmembers may depart the landing area unless necessary for their safety or preservation of life or property or unless a sterile area is available.

PERSONAL PROPERTY

The provisions of this section apply to personal property shipments moving into the CTUS at Government expense or under Government sponsorship, for the personnel indicated below. No distinction is made of whether they are returning to the

United States from extended duty overseas or are being transferred from one overseas station to another.

1. DOD military and civilian personnel and members of their families.
2. DOD-sponsored or directed individuals.
3. Employees of nonappropriated fund agencies that are integral parts of the military services and members of their families.

The duty-free exemption provisions of DOD 5030.49-R do not apply to employees of the American National Red Cross, contractors employed by the U.S. Government, or employees of military banking facilities unless such persons are returning to the CTUS under evacuation orders or instructions.

Household Goods and Unaccompanied Baggage

When used in this section, the following terms and definitions apply:

Shipment: All articles, items, and containers of baggage, household goods, privately owned vehicles, and other personal property shipped by or for one individual at one time.

Outer Container: The outermost container in which personal property is placed for transportation from the place of inspection under these regulations. This term includes such containers as commercial sea vans; CONEX cargo transporters or other transocean cargo transporters; and cases, crates, and barrels not placed in a cargo transporter at either an overseas inspection point or at the overseas port of embarkation.

Evidence of Extended Duty

Personnel are considered to have served on extended duty overseas as evidenced by any of the following situations:

1. Orders directing the return to the CTUS of a member who has been serving overseas in a permanent duty capacity, regardless of the duration of the individual's overseas service.
2. Orders directing the return to the CTUS of a member who has served overseas in a temporary capacity for 140 days or more.
3. Orders directing the return to the CTUS of a member who was directed to proceed overseas under orders that indicated an intention that he or she should serve at least 140 days overseas.

4. Orders directing the transfer of a member from one overseas activity to another overseas activity if the individual requests and if his or her commanding officer approves the return of personal property to the CTUS.

5. Orders directing the evacuation of any person, including but not limited to a member or the member's family, from overseas to the CTUS.

6. Orders directing the return to the CTUS under emergency conditions of the personal property of a member or a member's family in advance of the issuance of travel orders directing the individual's return to the CTUS.

7. Orders authorizing shipment to the CTUS of personal property effects of deceased persons who were serving overseas under DOD orders at the time of death, or of persons whose personal property and effects are to be shipped to the CTUS pursuant to the Missing Persons Act (37 U.S.C. 554).

8. Written command approval authorizing shipment to the CTUS of personal property of a member in advance of the issuance of travel orders. This approval must be accompanied by a written agreement executed by the member indicating shipment is made pending issuance of PCS orders.

9. A crewmember who has served continuously on a U.S. Navy vessel or support vessel while the vessel has been, or was intended to be, deployed for 120 days or more outside the CTUS. This also includes a member of a command or aircraft crew serving aboard such a vessel.

Duty-free Exemption Authority

Duty-free entry of personal property is authorized under those regulations listed in DOD 5030.49-R. This exemption applies to items taken out of the CTUS by the owner and to items acquired overseas that are for the owner's personal use or are intended as gifts for others. It does not apply to articles taken or shipped to the CTUS as an accommodation for others, or for sale, barter, or exchange. Articles acquired overseas must be in the member's direct personal possession prior to shipment to the CTUS to be authorized duty-free entry.

Personal property shipped or brought to the CTUS without competent orders or other evidence of extended duty is not inspected overseas unless an exception is specifically granted in advance by U.S. Customs. This also applies to baggage and other personal property of persons returning to the CTUS who are not directly connected with the performance of Government service

even though such persons or property are permitted to move in Government conveyances or at Government expense.

Shipments Not Entitled to Duty-free Entry

Shipments by individuals not entitled to duty-free entry of personal property and not returning from extended overseas duty are handled according to the following procedures:

1. Military customs inspections and examinations and U.S. Customs clearance procedures will be accomplished as prescribed earlier under the duty-free entry limitations section.

2. DD Form 1253 or 1253-1 is used and marked "Shipment Requires U.S. Customs Inspection."

3. Shipment will be palletized separately, if feasible, from those shipments cleared through use of US Customs Declaration for Personal Property Shipments, DD Form 1252, (fig. 13-9).

4. When required, the Transportation Control and Movement Document, DD Form 1384-2 (fig. 13-10) is prepared for each single and multiple shipment in accordance with DOD 4500.32-R.

5. The member will be instructed to prepare a Declaration for Free Entry of Unaccompanied Articles, Customs Form 3299 (fig. 13-11). This form may be completed overseas and made part of the shipment documentation, or it may be provided by the member directly to U.S. Customs at the U.S. port of entry.

Locked Containers

Locked containers may be inspected by U.S. Customs officials upon arrival at the U.S. port of entry. If keys for such containers are not available, the container may be opened by forcing the locks or by other appropriate means. This must be completed in the presence of a U.S. Customs official, and under the direct supervision of a commissioned officer, warrant officer, noncommissioned officer in pay grade E-5 or above, or DOD civilian of grade GS-7 or above. After examination, such containers are securely strapped or banded.

Restricted/Prohibited Articles

Under the laws and regulations administered by various U.S. Government agencies, certain articles are prohibited importation into the CTUS or are restricted importation. These articles are admissible only under

US CUSTOMS DECLARATION FOR PERSONAL PROPERTY SHIPMENTS		<i>WARNING</i> Any false statement or willful omission herein subjects the shipment to seizure and forfeiture or any person involved to a penalty equal to its value as well as to criminal prosecution.		CUSTOMS DECLARATION NUMBER	
DATA REQUIRED BY THE PRIVACY ACT OF 1974					
AUTHORITY 19 USC 1498					
PRINCIPAL PURPOSE To declare shipments of household goods, unaccompanied baggage, and privately owned vehicles for which free entry is claimed. Section A Owner customs declaration for type of shipment and reason for shipment Section B Military Customs Inspector certifies that property has been inspected/examined and provides customs inspector's stamp.					
ROUTINE USES (1) Use of your Social Security Number as proof of identification that person processing through Customs is not an impostor and also not in criminal prosecution if contraband or undeclared articles for which Customs fees are due are found in shipment. (2) Origin transportation officer and military customs inspector retain copies as proof that shipment has been properly processed. Copies are destroyed where no longer required.					
DISCLOSURE DISCLOSURE OF YOUR SSN IS VOLUNTARY, HOWEVER, FAILURE TO PROVIDE YOUR SSN AND OTHER REQUESTED PERSONAL INFORMATION MAY CAUSE DELAY IN PROCESSING THROUGH CUSTOMS PENDING POSITIVE IDENTIFICATION.					
PART I - HOUSEHOLD GOODS UNACCOMPANIED BAGGAGE AND PRIVATELY OWNED VEHICLES					
TO (Overseas FPOs, APOs)			FROM (Military customs inspector)		
SECTION A OWNER'S CUSTOMS DECLARATION					
LAST NAME FIRST NAME MIDDLE INITIAL (Print or type)				GRADE	SOCIAL SECURITY NUMBER
UNIT ADDRESS OVERSEAS (Include APO number)			ADDRESS IN US (Include Zip Code)		
1. DECLARATION FOR (Indicate by check of appropriate items) (Attach copy of orders)					
<input type="checkbox"/> HOUSEHOLD GOODS		<input type="checkbox"/> UNACCOMPANIED BAGGAGE		<input type="checkbox"/> PRIVATELY OWNED VEHICLE	
2. I DECLARE THAT (1) All items in this shipment to the United States consist only of personal property for my personal use of members of my family who have been residing with me. (2) The shipment contains no prohibited items. (3) Any articles which are (a) Restricted or (b) in excess of the quantities entitled to free entry under the law and regulations thereunder are listed and identified as such in the remarks space below (with the cost or face value, if not obtained by purchase, given for these not entitled to free entry) or if there are none, I have written the words "No Exceptions," in that space. (4) None of the items is to be taken or shipped to the United States as an accommodation for others or for sale, barter, or exchange. (5) This declaration is made for me and for _____ (Give number)					
members of my family. (6) Total quantities of alcoholic beverages and cigars included in this and other sets of customs declaration forms. Alcoholic beverages _____ (Give quantity) Cigars _____ (Give quantity) and (7) I have been serving overseas under competent U.S. Government orders and was (check appropriate item below)					
<input type="checkbox"/> a. Assigned to permanent duty overseas					
<input type="checkbox"/> b. Required to perform temporary duty overseas for 140 days or more					
<input type="checkbox"/> c. Assigned to temporary duty overseas under orders which intended the duration to be 140 days or more					
<input type="checkbox"/> d. Directed from one overseas duty station to another overseas duty station and return of my personal property to the United States has been approved as indicated in supplemental instructions to orders					
<input type="checkbox"/> e. Directed to evacuate myself, family or personal property to the United States					
<input type="checkbox"/> f. Directed to ship personal property in advance of the issuance of travel orders					
THE STATEMENTS ABOVE ARE MADE WITH FULL KNOWLEDGE OF THE APPLICABLE PROVISIONS OF DOD REGULATIONS 5030.49R AND OVERSEAS INSTRUCTIONS					
DATE			SIGNATURE OF OWNER		
SECTION B MILITARY CUSTOMS INSPECTOR'S CERTIFICATE					
I CERTIFY THAT (1) I have <input type="checkbox"/> inspected <input type="checkbox"/> examined the personal property in _____, even container(s) or vehicle covered by this certificate and have read the above statements which, to the best of my knowledge and belief are true (2) No unauthorized Government property is contained in the shipment (3) Regulations relative to quantities, disinfection, tags, labeling, or tagging and certificates have been complied with and (4) The property in the shipment is being forwarded to the					
Serial number(s) of seal(s) _____ (Give number) affixed to container(s)					
MILITARY CUSTOMS INSPECTOR STAMP			LAST NAME FIRST NAME MIDDLE INITIAL		GRADE
			SIGNATURE OF MILITARY CUSTOMS INSPECTOR		DATE
<i>REMARKS (Indicate (a) Reason for absence of your signature if not shown. (b) Kind, quantity and disposition of articles with drawn from shipment. (c) Prohibited restricted or apparently obsolete articles remaining in shipment and inspection (containers, number) ALSO draw a diagonal red line across face of form</i>			THIS COLUMN IS FOR USE OF US CUSTOMS OFFICERS ONLY		
SECTION C OVERSEAS PORT SHIPMENT DATA					
NAME OF CARRIER				VOYAGE OR FLIGHT NO	

DD FORM 1252
1 APR 77

REPLACES DD FORM 1252, 1 OCT 72 AND DD FORM 1252 (PAS), 24 SEP 75 WHICH ARE OBSOLETE

Figure 13-9.—US Customs Declaration for Personal Property Shipments, DD Form 1252.

TRANSPORTATION CONTROL AND MOVEMENT DOCUMENT

PAGE NO.

1. Doc Id	2. Trk Cont	3. Consignor	4. Comm-Spec Hdq	5. Air Dem	6. POE	7. POD
8. Mode	9. Pack	10. Trans Control No.	11. Consignee	12. Pti	13. RDD	14. Proj
15. Date Shpd	16. ETA	17. Tr. Acct				
18. Carrier	19. Flight-Truck-Voy Doc No.		20. Ref	21. Remarks	22. Pieces	23. Weight
24. Cube						
25 a. Trench Point (1)	b. Date Rec.	c. Bay Whse	d. Date Shpd	e. Mode Carrier	f. Flight-Truck-Voy Doc No.	g. Ref
26 a. Trench Point (2)	b. Date Rec.	c. Bay Whse	d. Date Shpd	e. Mode Carrier	f. Flight-Truck-Voy Doc No.	g. Ref
27 a. Trench Point (3)	b. Date Rec.	c. Bay Whse	d. Date Shpd	e. Mode Carrier	f. Flight-Truck-Voy Doc No.	g. Ref
28. Consignee	29. Date Received-Offered (Slip)		30. Condition			
31. Remarks						
32. Doc Id	33. Trailer-Container	34. Consignor Comm Abb Other	35. Commodity Spec Hdq	36. VOY NO Air Dem	37. POD Air Dem	38. M O D E
39. Type Pack	40. Transportation Control Number	41. Consignee	42. P R I	43. RDD a	44. REMARKS AND/OR Prg b Shpd c ETA d Tnc e	45. ADDITIONAL REMARKS OR Pieces f Weight g Cube h

REPLACES EDITION OF 1 APR 65, WHICH MAY BE USED

DD Form 1348-2, 1 Apr 66

Figure 13-10.--Transportation Control and Movement Document, DD Form 1348-2.



DECLARATION FOR FREE ENTRY OF UNACCOMPANIED ARTICLES

148 6 148 52 148 53 148 77 C R

PART I - TO BE COMPLETED BY ALL PERSONS SEEKING FREE ENTRY OF ARTICLES (Please consult with the Customs official for additional information or assistance. REMEMBER - All of your statements are subject to verification. False declarations or failure to declare articles could result in penalties)

1 IMPORTER'S NAME (Last, first and middle)		2 IMPORTER'S DATE OF BIRTH	3 IMPORTER'S DATA OF ARRIVAL
4 IMPORTER'S U.S. ADDRESS		5 IMPORTER'S PORT OF ARRIVAL	
6 NAME OF ARRIVING VESSEL/CARRIER AND FLIGHT/TRAIN			
7 NAME(S) OF ACCOMPANYING HOUSEHOLD MEMBERS (wife, husband, minor children, etc.)			

8 THE ARTICLES FOR WHICH FREE ENTRY IS CLAIMED BELONG TO ME AND/OR MY FAMILY AND WERE IMPORTED	A. DATE	B. NAME OF VESSEL/CARRIER	C. FROM (Country)	D. B/L OR AWB OR I.T. NO.
	E. NUMBER AND KINDS OF CONTAINERS			
F. MARKS AND NUMBERS				

PART II - TO BE COMPLETED BY ALL PERSONS EXCEPT U.S. PERSONNEL AND EVACUEES

9. RESIDENCY ("X" appropriate box) I declare that my place of residence abroad <input checked="" type="checkbox"/> is <input type="checkbox"/> was	A. NAME OF COUNTRY	B. LENGTH OF TIME Yr. Mo.
C. RESIDENCY STATUS UPON MY OUR ARRIVAL (X One) <input type="checkbox"/> (1) Returning resident of the U.S. <input type="checkbox"/> (2) Nonresident <input type="checkbox"/> a Emigrating to the U.S. <input type="checkbox"/> b Visiting the U.S.		

10. STATEMENT(S) OF ELIGIBILITY FOR FREE ENTRY OF ARTICLES
I, the undersigned, further declare that ("X" all applicable items and submit packing list)

<p>A. Applicable to RESIDENT AND NONRESIDENT</p> <p><input type="checkbox"/> (1) All household effects acquired abroad for which entry is sought were used abroad for at least one year by me or my family in a household of which I or my family was a resident member during such period of use, and are not intended for any other person or for sale. (810.10 TSUSA)</p> <p><input type="checkbox"/> (2) All instruments, implements, or tools of trade, occupation or employment, and all professional books for which free entry is sought were taken abroad by me or for my account or I am an emigrant who owned and used them abroad. (810.20, 811.10 TSUSA)</p> <p>B. Applicable to RESIDENT ONLY</p> <p><input type="checkbox"/> All personal effects for which free entry is sought were taken abroad by me or for my account. (813.10 TSUSA)</p>	<p>C. Applicable to NONRESIDENT ONLY</p> <p><input type="checkbox"/> (1) All articles of apparel, personal adornment, toiletries and similar personal effects for which free entry is sought, were actually owned by me and in the possession of myself or those members of my family who accompanied me at the time of departure to the United States and that they are appropriate and are intended for our personal use and not for any other person nor for sale. (812.10 TSUSA)</p> <p><input type="checkbox"/> (2) Any vehicles, trailers, bicycles or other means of conveyance being imported are for the transport of me and my family and such incidental carriage of articles as are appropriate to my personal use of the conveyance. (812.30 TSUSA)</p>
---	---

PART III - TO BE COMPLETED BY U.S. PERSONNEL AND EVACUEES ONLY

I, the undersigned, the owner, importer, or agent of the importer of the personal and household effects for which free entry is claimed, hereby certify that they were in direct personal possession of the importer, or of a member of the importer's family residing with the importer, while abroad, and that they were imported into the United States because of the termination of assignment to extended duty (as defined in section 148.74(d) of the Customs Regulations) at a post or station outside the United States and the Customs Territory of the United States, or because of Government orders or instructions evacuating the importer to the United States, and that they are not imported for sale or for the account of any other person and that they do not include any alcoholic beverage or cigars. Free entry for these effects is claimed under item 817.00, Tariff Schedules of the United States.

1. DATE OF IMPORTER'S LAST DEPARTURE FROM THE U.S.	2. A COPY OF THE IMPORTER'S TRAVEL ORDERS IS ATTACHED AND THE ORDERS WERE ISSUED ON
--	---

PART IV - TO BE COMPLETED BY ALL PERSONS SEEKING FREE ENTRY OF ARTICLES (Certain articles may be subject to duty and/or other requirements and must be specifically declared herein. Please check all applicable items and list them separately in item D on the reverse)

<p>A. For U.S. Personnel, Evacuees, Residents and Non-Residents</p> <p><input type="checkbox"/> (1) Articles for the account of other persons</p> <p><input type="checkbox"/> (2) Articles for sale or commercial use</p> <p><input type="checkbox"/> (3) Firearms and/or ammunition</p> <p><input type="checkbox"/> (4) Alcoholic articles of all types or tobacco products</p> <p><input type="checkbox"/> (5) Fruits, plants, seeds, meats, or birds</p> <p><input type="checkbox"/> (6) Fish, wildlife, animal products thereof</p>	<p>B. For Residents and Non-Residents ONLY</p> <p><input type="checkbox"/> (7) Foreign household effects acquired abroad and used less than one year.</p> <p><input type="checkbox"/> (8) Foreign household effects acquired abroad and used more than one year.</p> <p>C. For Residents ONLY</p> <p><input type="checkbox"/> (9) Personal effects acquired abroad</p> <p><input type="checkbox"/> (10) Foreign made articles acquired in the United States and taken abroad on this trip or acquired abroad on another trip that was previously declared to U.S. Customs</p> <p><input type="checkbox"/> (11) Articles taken abroad for which alterations or repairs were performed abroad</p>
--	---

Figure 13-11.—Declaration of Free Entry of Unaccompanied Baggage, Customs Form 3299.

certain specific conditions or in prescribed quantities. Such laws and regulations are for the protection of public health and plant and animal life in the United States. The prohibited articles are listed in DOD 5030.49-R.

FIREARMS AND AMMUNITION

DOD 5030.49-R prescribes procedures and outlines eligibility requirements for the importation into the United States of privately owned firearms and ammunition by DOD personnel. It also specifies controls to ensure compliance with regulations and documentation requirements of the Bureau of Alcohol, Tobacco, and Firearms (ATF), and the U.S. Customs Service, Department of the Treasury.

Procedures for the intrastate movement of privately owned firearms and ammunition, and importation of other than privately owned firearms and ammunition are contained in Navy regulations. Procedures for the export of privately owned firearms from the United States are also contained in Navy regulations and in the *International Traffic in Arms Regulation* (ITAR).

Military Customs Inspectors (MCIs) are responsible for the following:

1. Counseling members on their responsibilities for documentation and shipment requirements for privately owned firearms and ammunition
2. Ensuring that owners are furnished the criteria for evaluating handguns and advising owners to consult Rod and Gun Clubs, base exchanges, or ship's stores to ensure that firearms purchased through such facilities meet importation requirements.
3. Ensuring that owners are provided information relative to state laws and locally published ordinances.
4. Complying with the shipping and packing requirements outlined in this chapter.
5. Ensuring that firearms and ammunition shipments are supported with ATF-approved import permits, necessary proof, declarations or certificates, as appropriate, in accordance with the provisions of DOD 5030.49-R.
6. Ensuring that all firearms are unloaded
7. Executing Section E, Customs Inspector's Certificate, on DD Form 1252-1 upon completion of 5 and 6 above.
8. Indicating, by drawing a red diagonal line on the DD Form 1252, 1253, or 1253-1 and on the first page

of the DD Form 1252-1, those shipments containing firearms and/or ammunition, which require the attention of U.S. Customs officials at the U.S. port of entry. The above forms must be redlined when any of the following conditions exist:

a. The member fails to produce an AFT Form 6 for weapons or ammunition needing it.

b. There is insufficient documentation to support a member's claim that the firearms or ammunition are importable without an AFT Form 6.

c. The weapons are dutiable.

Owners of privately owned firearms and ammunition are responsible for

1. consulting with the local transportation officer to determine the importation requirements for firearms and ammunition;

2. complying with state laws and local ordinances regarding shipment of firearms and ammunition into their state of residence; and

3. following the processing and shipping procedures.

TRAINING AND APPOINTMENT

LEARNING OBJECTIVES: Determine who is responsible for the training of military customs inspectors. Explain training guidance for the various categories of customs inspection services. Describe how training assistance is obtained and identify the requirements for appointment as a Military Customs Inspector.

Training is the responsibility of the appropriate overseas command. Commands to which U.S. Customs Service (USCS) or Department of Agriculture (USDA) advisors are assigned should establish and conduct locally managed training programs using training materials provided by HQDA, USCS, USDA and other border clearance agencies. Training programs in overseas commands without assigned advisors will be conducted under the purview of USCS and USDA. These agencies, as appropriate, may designate or otherwise authorize DOD personnel assigned to the command to conduct training on their behalf.

Candidates for training and certification as MCIs must be carefully screened to ensure that they have an unimpeachable record and possess the highest standards of personal integrity.

MCI candidates should be trained in accordance with the requirements of their specific duties (such as passenger and baggage inspector, household goods inspector, agriculture inspector). On-the-job (OJT) instruction should be used to supplement formal training in those areas where the inspector will perform his or her duty.

Instructions should include, but not be limited to, the following subjects:

1. Customs, agriculture, and immigration orientation
2. Preparation of border clearance forms
3. Exemptions
4. Art of inspection
5. Drugs and drug enforcement
6. Firearms and ammunition
7. Restricted and prohibited articles
8. Customs enforcement
9. Inspection workshops (on-the-job training under supervision)
10. Smuggling methods of operation, concealment, and detection techniques

TRAINING GUIDANCE

The following information provides training guidance for the various categories of customs and agriculture inspection services required by DOD 5030.49-R.

<u>Category</u>	<u>Employment</u>	<u>Training Requirement</u>	<u>Level of Appointment</u>
Military Customs Inspector	Full/part time	Appropriate combination of USCS-approved formal classroom instruction and OJT, conducted by Military customs inspectors accredited by USCS.	Designated by the unified commander

<u>Category</u>	<u>Employment</u>	<u>Training Requirement</u>	<u>Level of Appointment</u>
Labor assistance to customs	As required	Determined and accomplished by the USCS inspectors	Not applicable
Augmentation personnel for customs inspection of ships and aircraft	Part time	Commanders of operational ships and aircraft returning from overseas should arrange to have key personnel undergo customs inspection instruction.	Unit or local commanders

TRAINING ASSISTANCE

Instruction, training material, and limited training aids are available from the U.S. Customs Service and the Animal and Plant Health Inspection Service, U.S. Department of Agriculture.

Requests for U.S. Customs Service and Department of Agriculture support from CONUS and overseas commanders should be forwarded through military channels to Deputy Chief of Staff for Logistics, HQDA (DALO-TSP-C), Washington, D.C. 20310.

APPOINTMENT

Military customs inspectors are appointed only after they have received proper training. Appointments are centrally controlled at a level designated by the unified commander.

In areas where customs inspection workload justifies fill-time assignments, appointments are made by written orders designating the individual as a military customs inspector (MCI). Each MCI is assigned an official accountable stamp with an identifying number, prefixed with a two-letter country identifier code. Format should be similar to that shown

in figure 13-12. The point of contact for issue and destruction of MCI stamps is:

COMMANDER-IN-CHIEF
US ATLANTIC FLEET
CODE N42131
NORFOLK VA 23511-5210

In areas where the customs inspection workload does not justify full-time assignment, individuals whose primary duty is law enforcement should be designated on written orders as military customs inspectors. When law enforcement personnel are not available, other responsible personnel meeting eligibility requirements may be designated in writing as military customs inspectors.

EXAMINED/INSPECTED BY

MILITARY CUSTOMS INSPECTOR NUMBER (e.g. GE 12345) Unit or Organization and APO/FPO

SIGNATURE

Figure 13-12.—Military Customs Inspection Stamp.

Certification/appointments are command specific and automatically terminate when the MCI is transferred to a new command. Recertification and refresher training for MCIs should be conducted periodically as conditions change or the individual situation warrants. Command military program managers should coordinate recertification/refresher training requirements with theater border clearance agency military advisors. Frequency of MCI recertification/refresher training is at the discretion of the command military program manager.

Information provided in this chapter will be helpful to the MA assigned to any type of customs duty. In-depth information regarding customs inspections may be found in DOD 5030.49-R.

SUMMARY

In this chapter, we discussed the Military Customs Inspection Program in terms of policy and command responsibility. We also identified who may serve as a military customs inspector, and we examined the procedures required for the various situations that require a military customs inspection. This chapter also investigated the training and appointment standards required for the military customs inspector.

CHAPTER 14

SHIPBOARD DUTIES

An MAC will normally be assigned duties as the Chief Master-at-Arms (CMAA) aboard ship, providing the MAC is the senior MA aboard. On larger ships, the executive officer (XO) may select an E-8 or E-9 as the CMAA. An MA1 reporting aboard ship can expect to be assigned to duties ranging from CMAA, assistant to the CMAA, or other MA-related duties (training PO for the MA force, investigate, and so forth). The CMAA in those cases may be an MAC or an MA1 serving on independent duty.

Aboard ship, the CMAA is responsible to the XO for maintaining good order and discipline. On larger ships, the CMAA may report to a limited duty officer or warrant officer (649X/749X) assigned as the security officer. To assist the CMAA, a number of persons of different ratings and, in some cases, lower rated MAs are assigned to the MA force.

On many small ships, assignment to the MA force of those persons of ratings other than MA may only be a collateral duty, and the MA functions are only performed on duty days. Aboard larger vessels, personnel of ratings other than MA are normally assigned on a TAD basis and perform full-time MA duties. These TAD personnel normally serve a period of 6 months.

The rated MA's primary duties, ashore and afloat, are law enforcement oriented. Aboard ship, however, many additional duties exist that are non-MA related, primarily because the number of officers, CPOs, and POs means that a great number of odd-jobs must be distributed evenly. Some tasking may be made because of the superior quality of leadership that should be the mainstay of all rated MAs. The MA must be thoroughly knowledgeable with all applicable ship's instructions that govern his or her specific duties and responsibilities.

DUTIES AND RESPONSIBILITIES OF THE CMAA

LEARNING OBJECTIVES: List and describe some of the duties of the CMAA.

Aboard a ship where no security officer is assigned, the CMAA functions as one of several executive

assistants to the XO and is responsible for the supervision of the MA force. The CMAA reports to the XO for the performance of assigned duties. For routine administration and accountability of personnel assigned to the MA force, the CMAA reports to a division officer assigned by the XO (normally X division). For the replacement of MA force personnel, the CMAA would normally forward a request to the personnel officer 30 days in advance of the desired transfer date.

SAFETY

The CMAA is a member of the enlisted safety committee. This committee is established to make recommendations concerning the ship's safety program to the safety council and to enhance interdepartmental communication in accident prevention.

TRAINING

The CMAA is responsible for making sure that all personnel assigned to the MA force are properly instructed in their duties. Time for instruction should be allotted each workday whenever possible.

PUBLICATIONS

Handling, correcting, and using official publications and directives are routine but important duties of the MA force. Much of the efficiency of the MA force depends upon your knowledge of the applicable publications and directives and how well you know how to use them.

The MA force must be able to identify the various publications, directives, and forms by title and have a good working knowledge of their contents.

SHORE PATROL AND BEACH GUARD

The CMAA afloat has the responsibility for training and/or briefing the ship's shore patrol and beach guard. When the ship is in a port where shore patrol and/or beach guard requirements exist, the CMAA should meet daily with personnel assigned to these duties to make sure they understand the scope of their responsibilities.

Shore Patrol

The primary mission of the shore patrol is to preserve order among members of the armed forces who are on leave or in a liberty status. They also provide assistance and information when necessary and apprehend, or otherwise control, military personnel who violate laws and regulations. Specific procedures for shore patrol are covered in chapter 12 of this manual.

Beach Guard

When boat landings are established, personnel may be assigned duty as beach guard. It is the duty of the beach guard to maintain order at the boat landing; control the boat traffic in the vicinity of the landing; enforce safety precautions both at the landing and in the boats; and see that boats are not left unattended, that the crews are in proper dress, and that the boats are not overloaded. As a beach guard, you should be particularly careful to make sure coxswains obey the Rules of the Road, boats do not back into the way of moving vessels, other boats are not endangered by the wake from Navy boats, and liberty boats are not overloaded with personnel. If adverse conditions warrant, the senior person at the landing may refuse to load boats or may request the ship provide boat officers for their craft.

I DIVISION

The I Division officer is appointed by the XO. The CMAA may be assigned this duty. If another person is assigned, the CMAA assists the I Division officer in supervising and coordinating the indoctrination of newly assigned personnel.

Persons assigned as I Division instructors should report to the I Division officer for a briefing of their duties at least 10 minutes before to their scheduled period of instruction.

EXECUTION OF THE SHIP'S ROUTINE

The CMAA assists the officer of the deck (OOD) in the execution of the ship's routine, including taps, maintaining silence after taps, supervising the control of standing lights, and the crew's turning out promptly for all-hands evolutions.

Other duties for which the CMAA is responsible are listed in OPNAVINST 3120.32, *Standard Organization and Regulations of the U.S. Navy* (SORM). The CMAA

should frequently review the SORM and make sure it remains up to date, including any ship's modifications.

DUTIES AND RESPONSIBILITIES OF THE MASTER-AT-ARMS FORCE

LEARNING OBJECTIVES: List and describe the pertinent duties of the MA force.

Personnel assigned to the MA force are responsible to the CMAA for assisting the OOD in the execution of the ship's routine. Pertinent duties of the MA force are detailed in the following paragraphs.

ROUTINE DUTIES

Aboard ship all persons except authorized "late sleepers" are required to turnout of their bunks promptly at reveille. To ensure compliance, the MA should walk through the berthing compartments 15-20 minutes tier reveille. Names of personnel remaining in their bunks should be taken and either checked against the list of authorized late sleepers or be provided to the person's leading petty officer. Names of repeat offenders should be reported to the CMAA for action. On larger ships, a "Reveille PO" is sometimes assigned this responsibility.

During all-hands evolutions, frequent inspections of the unit should be conducted by the MA force. Persons shirking duty should be reported to the officer in charge of the evolution.

The MA force should know the lighting requirements for standing lights and know where the lighting switches are located. Standing lights are turned on at sunset and are secured at sunrise unless otherwise directed by proper authority. This task is usually handled by the messenger of the watch, but supervisory control of the standing lights lies with the CMAA.

At sea, MAs may periodically be sent topside after Darken Ship is set to check for light leaks or violations and to ensure the smoking lamp restriction is enforced on deck. Violators should be reported to the CMAA. Light leaks caused by equipment problems should be reported to the OOD and damage control central.

When taps has sounded, MA force personnel should tour the ship to ensure compliance. All white lights should be turned off and red lights turned on in berthing compartments. Radios, tape players, and the like should be turned off and internal noise kept to an absolute minimum. External noise should be kept at a level that will not disturb persons trying to sleep.

The responsibility for enforcing rules and regulations lies not only with personnel of the MA force, but with every military person aboard ship. When a rule or regulation is violated, the MA should take immediate action to correct the situation. If the violation can be corrected immediately, take steps to do so. If the problem cannot be corrected immediately, make sure explicit instructions are issued to the violator. Follow up to ensure the violator follows the instructions. Violations such as improper uniforms or haircuts should be brought to the attention of the violator's immediate supervisor. Placing a person on report should be the absolute last resort for minor offenses. However, when persons are involved in more serious offenses, such as unauthorized absence, assault, or possession of drugs or narcotics, or are frequently involved in minor offenses, you have no alternative but to place the violator on report.

LIBERTY PARTIES

An MA should be present to assist the OOD in controlling departing and returning liberty parties. The quarterdeck area should be kept clear of unnecessary personnel at all times. In accomplishing this task, MAs should use a great deal of tact and diplomacy. A person returning to the ship under the influence of alcohol should be handled very carefully. If a confrontation develops, the MA should remove the individual from the quarterdeck as quickly as possible, with only the minimum amount of force required. A word of caution: Never THREATEN to use physical force. If it becomes necessary to use force, use it.

VISITING

General visiting will be permitted aboard ship only as authorized by competent authority. Personal visits by relatives and friends of the ship's company should be authorized by the commanding officer.

Public Affairs Officer

When authorized visitors are to be received aboard, the public affairs officer should prepare suitable literature for distribution to them. Such matters as the history of the ship and a brief on the origin of the ship's name may be included. The public affairs officer should also obtain copies of the visitor's boat schedules and should distribute them to the MA at the landings and to the public through local public affairs officers.

Deck Department Head

The deck department head (weapons officer or first lieutenant) should organize and instruct guides for the visitors and should designate heads and other facilities for visitor's use. This officer should also prepare special boat schedules for visitors and provide copies to the public affairs officer after they have been approved by the XO.

Damage Control Assistant

The damage control assistant (DCA) normally is responsible for preparation of NO VISITORS and NO SMOKING signs. These signs are placed in appropriate places by the various department heads. The NO SMOKING signs are placed where required, and the NO VISITOR signs at each access to restricted areas (combat information center, radio central, emergency radio, sonar spaces, weapons system spaces, ready-service weapons rooms, magazines, engineering spaces and auxiliaries, electronic warfare spaces, plot and IC rooms, and so forth). Be sure to check the ship's addendum to the SORM to ensure all restricted spaces are posted.

Department Heads

Heads of departments also provide sentries as necessary at accesses to restricted areas and for surveillance of traffic routes. They make sure the ship is ready to receive visitors and observe the progress and conduct of the visit. They also ensure the security of restricted matter and spaces, such as classified publications and correspondence, equipment, and ammunition.

Guides

As visitors arrive, the OOD will assign a guide to groups of approximately 10-15 visitors, have literature distributed, and direct the guides to commence the tour following a prespecified route. Unless authorized by the commanding officer, visitors' cameras should be checked with the OOD, who should make sure they are tagged with the owner's name and are properly safeguarded.

Guides should point out and explain items of interest, request visitors to remain together, and be alert for their safety.

Some procedures for the guides may include the following:

- Know the route thoroughly, including locations of hazardous areas, restricted spaces, visitor head facilities, first aid boxes, and telephones. Be equipped with a map of the tour route showing the above spaces and have a flashlight in the event of a power failure.
- Know how to use communication equipment, including hand-held radios (if issued), ship's telephones, sound-powered equipment, and "squawk boxes." Provide written information to the guides listing the telephone number(s), sound-powered circuit information, and/or squawk box information for the quarterdeck, sick bay, and DC central.
- Require the guides to count the number of persons in each party before and after the tour and to report any discrepancies to the OOD. If enough persons are available, a guide should be assigned to lead the party and another person assigned to follow the visitors to collect stragglers.
- If an emergency situation develops, the guide should not leave the party unattended but should use the nearest radio or telephone to call the OOD. These situations may include persons knowingly leaving the tour route; creating disruptions; attempting to force their way into restricted areas; medical emergencies; lost children; and any number of similar problems.

The CMAA

The CMAA may be responsible for posting and instructing sentries and guides and for general policing of visitor areas, observance of safety precautions, general good order, and compliance with visitor instructions. The CMAA may also have departmental duty petty officers act as roving patrols to assist sentries and guides and to make sure they remain properly stationed and alert.

The MA Force

Immediately following the debarkation of the last visitor, a thorough inspection should be conducted by the MA force to make sure all visitors have cleared the ship. Results of this inspection should be reported to the OOD.

INSPECTIONS

The procedure for conducting zone inspections is normally outlined in the ship's bills or instructions. The

primary function of the MA force during zone inspections is to act as guides for the inspectors. The CMAA normally escorts the commanding officer.

The DCA is responsible for preparation of the zone inspection procedure. The XO usually designates the inspection parties for each zone. Division officers should make sure personnel are standing by their spaces during the inspection.

Personnel inspection procedures differ from ship to ship. The CMAA should understand the process, including any special requirements of the commanding officer. Questions regarding the process should be referred beforehand to the XO. The CMAA normally escorts the commanding officer. The commanding officer may refer questions regarding grooming and uniform standards to the CMAA during the inspection. It is, therefore, very important to keep abreast of any changes to the uniform regulations.

EMERGENCIES

Adequate personnel from the MA force should be present at the scene of emergencies to maintain order and to keep the scene clear of unnecessary personnel.

When the word is passed that a person is overboard, the MAs maybe directed to search the ship for persons failing to muster. The CMAA should make sure the ship is divided into specific search areas to ensure a quick but thorough and orderly search.

During general quarters, the MAs maybe assigned to various battle stations. If not, establish roving patrols to safeguard any personal gear or valuables left unsecured by crew members.

ENTERING AND LEAVING PORT

One hour before getting underway, personnel of the MA force should make an inspection of the ship for stowaways and make a report of the inspection to the OOD at least 30 minutes before sailing.

On entering and leaving port, all hands topside should be in the specified uniform. Unless mustered at quarters, idlers should be kept clear of the decks.

REPORTS

You may often be required to make reports to various officers aboard ship. These may include 8 o'clock reports, inspection reports, and reports of incidents. Some instances may require a formal incident/complaint report.

NONJUDICIAL PUNISHMENT, COURTS-MARTIAL, AND COURTS OF INQUIRY

The *Manual of the Judge Advocate General* (JAGMAN) establishes the procedures at captain's masts, courts-martial, or courts of inquiry. However, the formalities before to and at the termination of the captain's mast are determined by custom and tradition, and each command may set its own procedures and directives. Chapters 5 and 6 of this manual explain in detail captain's masts, courts-martial, and courts of inquiry.

Here are some of the duties you may encounter—duties you should be familiar with:

You may be assigned the duty of guarding prisoners at a court-martial. When performing this duty, station yourself in a position so you can observe the prisoner at all times and close enough to the prisoner so that, should the prisoner become violent, you will be in a position to prevent injury to anyone, including the prisoner. You may also be required to make sure that the accused, witnesses, and interested parties are present. There may be times when you will be stationed outside the door to the room where the hearing is being conducted to summon witnesses. Remain alert at all times and make sure that quiet is maintained in the immediate area.

Prisoners being tried may be delivered in handcuffs if circumstances warrant. If so, the cuffs should be removed during the proceedings unless otherwise ordered by the senior member present.

Upon completion of the court and depending upon the sentence awarded, the MA may take charge of the accused immediately upon sentencing.

SHIP'S BRIG RESPONSIBILITIES

Brigs aboard ship are places of confinement included in the original construction or added during an authorized conversion. Shipboard brigs are authorized and certified for the confinement of personnel attached to or embarked in the ship. Persons with more than 30 days of confinement remaining to be served upon delivery are normally delivered to a shore station brig for confinement. Shipboard brigs are operated in full accord with provisions of the *Department of the Navy Corrections Manual*, SECNAVINST 1640.9. The brig officer and brig staff (normally MAs) ensure the safety of prisoners in the brig and their release in time of emergency.

The *Department of the Navy Corrections Manual* contains all the information on brig operations and transfer of prisoners. This manual should be used for guidance when dealing with anything that pertains to brigs or prisoners.

SAFETY

Personnel of the MA force perform the following duties regarding safety:

- Act as roving inspectors, looking for safety hazards and risks that could result in injury to personnel or damage to equipment. Safety hazards/violations found in this category should be corrected immediately.
- Assist the safety officer in keeping the safety program viable and workable.
- Carry out a system of internal reporting to focus command attention on material deficiencies and operating practices that jeopardize personnel and equipment.

BURIAL AT SEA

LEARNING OBJECTIVES: Describe the requirements for burial at sea in terms of eligibility, preparation of remains, and the burial at sea ceremony. Identify the procedures used when the remains have been cremated.

In early naval history, burial at sea was a necessity when death occurred aboard ship. This is seldom necessary today. Except under extreme conditions, as ordered by the commanding officer, burials at sea do not take place except when specific arrangements have been made at the request of the deceased's primary next of kin.

ELIGIBILITY FOR BURIAL AT SEA

The regulations for at-sea disposition of remains from a naval vessel or inurned cremains from a naval aircraft are set forth by the Bureau of Medicine and Surgery (BUMED).

Civilian personnel are not authorized to attend services aboard ships, aircraft, and auxiliary craft. Services aboard ship while it is in port are permitted on a not-to-interfere basis.

RESPONSIBILITY FOR PREPARATION OF REMAINS

It is the responsibility of a naval hospital to ensure the caskets are suitably prepared. In general, this includes the following:

- Metal caskets only are used, banded with five 3/4-inch bands of durable material (not metal).
- A minimum of 20 2-inch holes are drilled in the casket (at least eight on top, eight on the bottom, and two on each end).
- The casket must weigh at least 300 pounds. If it does not meet this minimum, additional weight should be added at the foot end.

If the casketed remains do not submerge upon entering the water, the commanding officer of the ship, while maintaining the dignity of ceremony, should take necessary measures to make sure it submerges. Normally, the casket should be retrieved and proper steps taken to ensure it will submerge, then the casket returned to the sea. Under no circumstances should gunfire be used to cause the casket to submerge.

PREPARATION FOR THE BURIAL AT SEA CEREMONY

There are two component parts of the ceremony of burial at sea—religious and military. The reading of the scripture and prayers, the committal, and the benediction constitute the religious part and may be performed by the chaplain or commanding officer, or

by an officer designated by him or her. All other aspects of the ceremony are performed by other personnel.

For burial at sea, the casketed remains should be covered with the national ensign with the union placed at the head and over the left shoulder (fig. 14-1). When the casket is draped with the national ensign, the cape and sword of the deceased are not displayed.

Six pallbearers form according to height, three on each side of the casket. Pallbearers will uncover when they are below decks and not carrying the casket. At all other times they remain covered.

The selected place for committal is usually a part of the weather deck with a reasonably unobstructed area in which to form the detail and is usually in the after part of the ship. Before the ceremony, the CMAA should make sure the site is cleaned and properly rigged. When the casketed remains are brought on deck the casket is placed securely on a stand, if necessary, with the feet outboard, at a right angle to and extending over the side.

Attention is sounded (by bugle, bosn's call, or word of mouth) as the pallbearers, preceded by the CMAA, execute the hand salute as the cortege passes to the place selected for the committal. When the remains have been so placed, the hand salute is terminated by those in sight, and a sentry is posted unless the burial service is to follow immediately.

A CPO may be designated to take charge of the firing squad. The CMAA directs the pallbearers during the service until the flag is encased and delivered to the commanding officer.

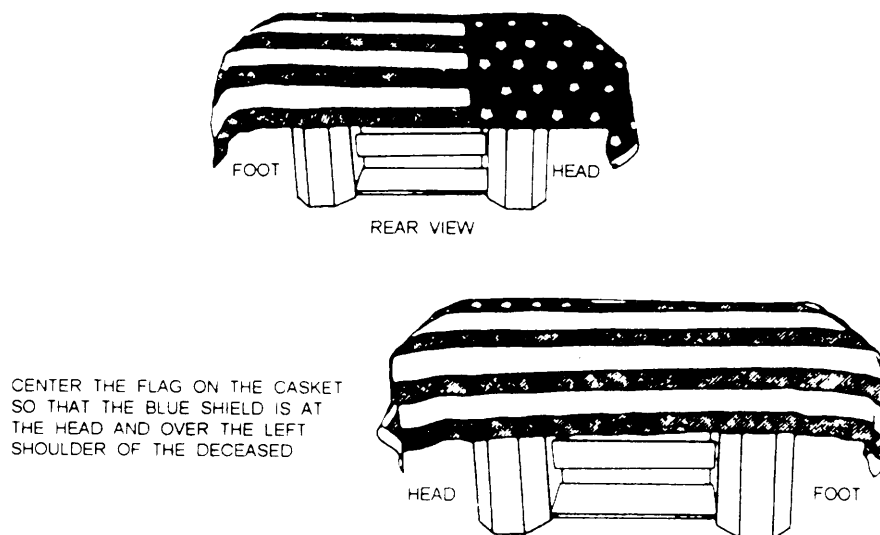

Figure 14-1.—Correct method of displaying the flag with the casket.

THE CEREMONY FOR BURIAL AT SEA

Assemble all participating personnel and form as illustrated in figure 14-2, space permitting. When the honor platoon has been assembled in massed formation and has been brought to parade rest, the burial service begins and is read through to the end of the prayers. During prayers, the assemblage remains covered with bowed heads. After the conclusion of the prayers, if the name of the deceased was not included in the service, it is fitting to be mentioned. Upon conclusion of the prayers, the pallbearers should hold the casket and national ensign in place by hand as may be necessary before the reading of the committal.

When these preparations have been completed and all is in readiness, attention is sounded. The command FIRING SQUAD, PRESENT ARMS is given. Simultaneously, the honor platoon responds with a hand salute, and the reading of the committal begins. When the indicated word of the committal is read, the pallbearers tilt the board until the casket slides along it, under the national ensign, overboard into the sea. As it slides overboard, the pallbearers retain the board and national ensign and stand fast.

The commands FIRING SQUAD, ORDER ARMS and PARADE REST are given, and all hands bow their heads. The benediction is pronounced. Then follow the commands FIRING SQUAD, ATTENTION, and FIRE THREE VOLLEYS. The honor platoon hand salutes and remains so until the last note of taps (if taps is not sounded, hold the salute until the last volley of fire READY, AIM, FIRE; AIM, FIRE; AIM, FIRE. After the last volley, the firing squad remains at the ready

position, pieces locked, until the conclusion of taps, then salutes.

Upon completion of taps, the firing squad is brought to ORDER ARMS. The pallbearers encase the national ensign by folding. (Detailed directions for folding the flag can be found in the *BlueJackets Manual*.) It is then presented by the CMAA to the commanding officer.

After the commanding officer has received the flag and has departed, the command PARADE REST is given, and when all have assumed it, the personnel details (firing squad and pallbearers) are brought to attention, formed, and marched away. When they are clear, the honor platoon is brought to attention; retreat is sounded; and the ceremony is over.

CREMATION

In cases where the remains have been cremated and the receptacle containing the ashes has been received on board for burial at sea, the following procedures will govern:

If the receptacle is to be opened and the ashes scattered at the time of committal, a small table or stand should be securely rigged beforehand at the selected place for the committal. The receptacle should be placed on this table or stand during the reading of the service. The folded flag should be placed on the stand beside the remains. The XO or some other officer appointed by the commanding officer will assume responsibility for opening the receptacle and scattering the ashes (keeping in mind the wind factor) at the appropriate time during the committal ceremony.

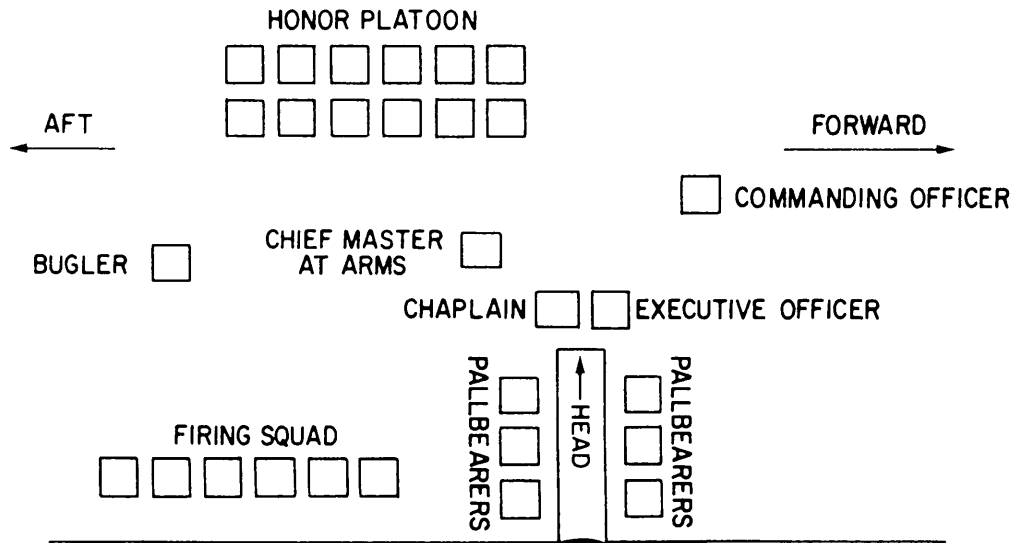

Figure 14-2.—Deck plan for burial at sea.

If the receptacle is to be committed together with the ashes, a small platform should be constructed and rigged so that during the service the receptacle may rest thereon and be launched at the time of committal by tilting up the inboard end of the platform, thus permitting the receptacle and ashes to slide overboard.

The ashes received for committal at sea will sometimes be accompanied by floral tributes, which may be used to surround the receptacle and cover the platform or table on which it rests during the service. The flowers may be permitted to slide overboard with the cremains or be tossed into the sea by a flagbearer after the receptacle has been launched or the ashes have been scattered.

For all phases of the funeral where the cremains have been carried by hand, one person should be detailed to carry the receptacle containing the ashes.

Four enlisted members are detailed as flagbearers and serve in place of the six pallbearers otherwise required. The flagbearers follow the bearer of the receptacle as it is brought on deck and carried to the place of committal. The prefolded flag is carried by the leading flagbearer on the right. The flag is then placed on the stand beside the cremains. The flag will be picked up and held folded by the flagbearers during the committal of the ashes to the sea.

Before any burial at sea, you should review applicable BUMED directives. Complete detailed information concerning burial at sea is contained in *Navy Military Funerals*, NAVPERS 15555.

PERSONAL EFFECTS

LEARNING OBJECTIVES: Determine how the personal effects of both enlisted and officer personnel should be handled when these individuals are no longer able to care for them. List and describe the five classes and categories of personal effects, and identify who is responsible for the personal effects that have been collected. Explain inventory requirements and the action that should be taken by the inventory board.

No person other than those authorized by directives will handle or disturb in any way the personal effects of another person.

ENLISTED PERSONNEL

When any enlisted person on board a naval unit is declared a straggler or becomes mentally or physically incapacitated and can no longer care for his or her personal effects, they should be collected, inventoried, and sealed by a division petty officer in the presence of the division officer and an MA. The effects should be delivered to the CMAA for safekeeping and disposition according to current directives.

OFFICER PERSONNEL

The personal effects of an absent or incapacitated officer will be inventoried and packed by two officers designated by the XO and delivered to the supply office for safekeeping and disposition according to current directives.

CLASSIFICATION OF PERSONAL EFFECTS

Personal effects consist of the articles owned by an individual, as well as articles of government property in his or her temporary custody. Personal effects are classified and described as follows:

- Class 1. Navy-owned, organizationally furnished clothing and equipment, furnished on a loan or custody basis and subject to turn-in when no longer required. In determining that items in class 1 are Navy-owned, consideration should be given to the fact that large quantities of such material have been sold by naval activities to private individuals and to retail commercial enterprises. When Navy ownership of items in class 1 cannot be established conclusively, such items will be included in class 5.

- Class 2. Uniform clothing prescribed by U.S. *Navy Uniform Regulations*.

- Class 3. Money.

- Class 4. Negotiable and nonnegotiable instruments, such as bonds, checks, notes, deeds, wills, receipts including those covering safekeeping deposits, agreements, certificates, insurance policies, and bankbooks.

- Class 5. Miscellaneous articles of intrinsic, sentimental, or utility value, such as jewelry, fountain pens, cameras, wallets, insignia medals, photographs, books, diaries, razors and other toilet articles, flight logs, and other personal papers, souvenirs, firearms, musical instruments, sports and athletic equipment, civilian

clothing, wardrobe trunks and other containers suitable for shipment as baggage, motor vehicles, trailers, boats, and household goods.

CATEGORIES OF PERSONAL EFFECTS

Personal effects are categorized as follows:

- Category 1. Lost, abandoned, or unclaimed personal effects. This includes the personal effects of persons whose identity or location cannot be determined; personal effects of persons in the Navy who have been declared absentees or deserters; and personal effects unclaimed by the next of kin, the heir, or the legal representative when such personal effects were the property of deceased persons who were not members of the armed services.

- Category 2. Personal effects of deceased or missing Navy personnel. This category includes the personal effects of persons who are determined to be deceased or missing. A *missing person* is one who, because of the circumstances incident to his or her absence, is not declared an absentee or a deserter. The personal effects of absentees and deserters are considered to be abandoned personal effects and are identified as in category 1.

- Category 3. This category includes the personal effects of incapacitated persons (personal effects of persons determined to be mentally or physically incapacitated).

- Category 4. Lucky bag items. This category includes items of clothing and other personal effects that are deposited in the ship's lucky bag when such items are found adrift or when such items are donated.

- Category 5. This category includes the personal effects unavoidably separated from the owner.

RESPONSIBILITY FOR PERSONAL EFFECTS

Upon receipt of personal effects from inventory boards, the supply officer is responsible for the custody, storage, security, shipment, and disposition of personal effects, and for the maintenance of adequate records.

INVENTORY

Lost, abandoned, or unclaimed personal effects should be inventoried when the effects first come into the custody of a naval activity. Also, personal effects should be inventoried when the owner is determined to

be deceased or missing. It is important in this instance that the inventory be completed as promptly as possible so the next of kin, heir, or legal representative can receipt for the personal effects without undue delay. The personal effects of incapacitated persons should be inventoried when such action appears necessary or desirable to protect the interests of the incapacitated person.

When an inventory of personal effects is required, the commanding officer will appoint, verbally or in writing, an inventory board. The inventory board should consist of two members, one of whom (when practical) should be an officer.

ACTION BY THE INVENTORY BOARD

The inventory board should take an accurate and complete inventory of the personal effects and investigate and record any information that may assist in the settlement of the affairs or the estate of the owner. All articles of personal effects except as specified below should be described in detail in the section List of Personal Effects on the reverse of the Inventory of Personal Effects (NAVSUP Form 29).

Classified Material

The inventory board should remove from the personal effects all classified matter, which should be disposed of according to the *Department of the Navy Information and Personnel Security Program Regulation*, OPNAVINST 5510.1.

Objectionable Material

Pornographic or similar matter, including personal letters containing objectionable matter, should be removed from the personal effects and disposed of as directed by the commanding officer. This material should not be recorded on the inventory.

Articles Injurious to Personnel

Articles injurious to personnel, such as small arms ammunition or other explosives, and articles that constitute a fire hazard should be rendered harmless if practical. If such articles cannot be rendered harmless, they should be disposed of by qualified personnel.

Inventory of Valuables

Extreme care should be exercised in describing articles of intrinsic or sentimental value, such as jewelry,

precious stones, valuable papers, and keepsakes. Such general terms as *diamonds*, *gold*, and *platinum* should not be used without qualifying remarks, as such articles may not, in fact, consist of these elements. Money should be recorded on the inventory form by denomination and value of the currency. When desirable or appropriate, the inventory board may determine whether the owner of the effects has any debtors or creditors within the command.

Complete detailed information concerning the handling and distribution of personal effects is contained in *Afloat Supply Procedures*, NAVSUP Pub 485.

EVACUATION OF CIVILIANS

LEARNING OBJECTIVES: List the responsibilities of various shipboard officers when civilians are evacuated. Describe the general plans, embarkation-debarkation, and processing of evacuees. Determine messing and berthing requirements and state the general quarters and emergency stations for evacuees.

The XO is responsible for establishing an evacuation bill aboard ship, assigning responsibilities, and issuing general plans for evacuating civilian personnel from unfriendly shores or disaster areas. Situations will differ in regard to the number and sex of passengers embarked and the length of time on board. Detailed plans should be formulated after assignment to a specific evacuation mission.

RESPONSIBILITIES

Responsibilities for planning and executing an evacuation mission are as follows:

The XO will organize, direct, and supervise the operation, assisted by the executive staff and other personnel as required

The Operations Officer is responsible for the following:

- Organizing and directing ship-to-shore movements and embarkation and debarkation
- Organizing and directing a beach guard to supervise and control the loading and dispatching of boats ashore

- Directing such officers and enlisted personnel as the XO may request to process and control evacuees

The Supply Officer is responsible for the following:

- Organizing, directing, and supervising the messing of evacuees
- Issuing of clothing and supplies to evacuees as the XO may direct

The Wardroom Mess Officer/Caterer is responsible for assigning staterooms and head facilities to evacuees as required

The Medical Officer is responsible for organizing and directing the necessary medical facilities for the health of evacuees and the care and treatment of the sick and injured.

The Administrative Assistant is responsible for the following:

- Supervising a census of evacuees
- Issuing such orders and instructions to evacuees as the XO may direct
- Supervising the assignment of berthing and head facilities to evacuees as required

The Weapons Officer or combat systems officer is responsible for the organization and direction of such sentry details as the XO may direct.

The CMAA is responsible for directing the MA force in such policing duties as the XO may direct.

The First Lieutenant is responsible for providing all unassigned life jackets for issuance to evacuees as the administrative assistant may request.

GENERAL PLANS

Transportation of civilians in excess of available facilities will constitute a problem in berthing and messing. Evacuees should be berthed and subsisted as personnel of embarked units or passengers according to the provisions of the evacuation bill and other directives issued by the XO.

EMBARKATION-DEBARKATION

All available ship's boats and any other available boats in the vicinity should be used for the ship-to-shore movement. Loading and dispatching from the beach should be under the direction of the beach guard officer.

Boating at the ship should be controlled by the OOD and any assigned officer assistants.

Helicopter/fixed-wing aircraft attached to a ship should be loaded and dispatched from the beach under the direction of the beach guard officer. Landing and dispatching of aircraft at the ship should be controlled by the Air Officer as scheduled by the Operations Officer.

No baggage or household effects of evacuees should be loaded except that which can be readily carried by the owner.

All accommodation ladders should be rigged when embarking/debarking by boat. Cargo nets and Jacob's ladders may be used to embark evacuees if necessary.

ORGANIZATION AND PROCESSING OF EVACUEES

As evacuees are embarked, sentries should direct them to specified areas for census and berthing assignments under the direction of the Personnel Officer and the Wardroom Mess Officer/Caterer.

Men and women evacuees should be divided into separate groups. The groups should be further divided into units of 10 persons for administration and processing.

Officers assigned by the Operations Officer and assisted by sentries provided by the Weapons Officer should direct and supervise evacuees under the direction of the XO or the Administrative Assistant acting for the XO.

The administrative assistant should record data for each evacuee on an Evacuee Census Card (fig. 14-3) before to berthing, messing, and assigning emergency stations.

Evacuees should be examined by a doctor or corpsman to determine the general state of their health and to detect injuries or diseases requiring treatment.

Injuries or apparent diseases should be noted on their census card. On the advice of the Medical Officer, one compartment should be designated as a sick bay for evacuees.

The First Lieutenant should make life jackets available for issuance to each evacuee when registered. If the supply of life jackets is inadequate, women and children should be given preference. Life jackets should be in each person's immediate possession at all times.

Evacuees should wear a name tag at all times while aboard. The tag should bear the evacuee's name, berthing space, and unit number. The Supply Officer should make sure that an adequate supply of tags is on board and delivered to the Administrative Assistant, upon request, when the provisions of the evacuation bill are placed into effect.

The XO should select unit leaders from among the several evacuees. These unit leaders should be spokespersons, and all directions and orders to evacuees are made through them. Brassards should identify the unit leaders. If practical, unit leaders should speak a common language.

MESSING

Evacuees should be subsisted on separate messdecks at regular hours; however, if there is overcrowding, the supply officer should organize and direct an "around the clock" feeding system, to make sure the evacuees are adequately fed.

The unit leaders should detail certain evacuees to mess duties. The number so detailed and their assignment to duties should be determined by the Supply Officer with the concurrence of the XO.

BERTHING

If it becomes necessary to displace ship's company personnel from assigned living spaces in order to berth

NAME _____	SEX _____	DATE OF BIRTH _____
ADDRESS _____		CITIZENSHIP _____
NEXT OF KIN _____		RELATIONSHIP _____
ADDRESS _____		
DEPENDENTS _____		
UNIT NO. _____	INJURY OR DISEASE _____	
COMPARTMENT _____		

Figure 14-3.—Evacuee census card (sample format).

evacuees, they should, as far as practical, be doubled up with personnel attached to their respective departments. Rotation of bunks by watches may be used to provide sufficient berthing spaces for enlisted personnel, as well as evacuees.

Where possible, evacuees should be located in one section of the ship to facilitate handling and control. Evacuees assigned to a particular unit should be berthed in the same compartment.

GENERAL QUARTERS AND EMERGENCY STATIONS

General quarters stations for evacuees should be in their assigned berthing spaces. In the event that emergency stations are ordered, evacuees should remain in their assigned living spaces until directed to assemble at a topside station to abandon ship. In emergency situations, orders should be given to evacuees over the 1MC announcing system.

The administrative assistant should be in command of evacuees during an abandon-ship evolution and should direct their movements through the designated unit leaders.

The Administrative Assistant should provide instruction to evacuees on the various alarms for general quarters and emergency stations and the action required.

PRISONERS OF WAR

LEARNING OBJECTIVES: Identify who is responsible for the Prisoner of War bill. Outline the responsibilities of the various shipboard officers with regard to prisoners of war. Explain the procedures to be followed when prisoners are taken and describe how prisoners of war should be treated.

The XO is responsible for establishing a Prisoner of War bill aboard ship, assigning responsibilities, and providing procedures for handling prisoners of war.

This bill applies equally to combatant forces of the enemy and to individuals traveling with an armed force. Individuals following the armed forces of the enemy (such as newspaper correspondents, contractors, technicians, and vendors) and the officers and crews of enemy merchant ships, if detained, should be entitled to treatment as prisoners of war if in possession of proper identification. Prisoners of war are subject to the *Uniform Code of Military Justice* (UCMJ).

RESPONSIBILITIES

The First Lieutenant should do the following:

- Take custody of prisoners, and make sure they are properly searched separate, guarded and deprived of means of escape, revolt, or acts of sabotage.
- Prepare muster lists of prisoners.
- Have the prisoners photographed for record purposes.
- Arrange with the Supply Officer for provision of standard rations.
- Arrange with the Wardroom Mess Treasurer and Personnel Officer for provision of bedding and suitable living spaces for both officer and enlisted prisoners.
- Prepare identification papers for each prisoner, using description, fingerprints, and photographs.

The Wardroom Mess Treasurer and Personnel Officer should provide bedding and suitable living spaces.

The Medical Officer should do the following:

- Examine all prisoners and provide necessary medical treatment.
- Prescribe personal effects necessary for prisoner's health.

The Supply Officer should do the following:

- Provide the standard rations as requested.
- Issue items of clothing or small stores as directed by the Commanding Officer or as requested by the First Lieutenant/Commanding Officer of the Marine Detachment.
- Provide suitable storage for the safekeeping of valuables removed from prisoners and delivered to his or her custody.

The Intelligence Officer (if assigned) or Communications Officer should take possession of all arms, military equipment, and military documents in the possession of the prisoners. All effects and articles of personal use should remain in the possession of the prisoners, including protective clothing. In particular, the identity card issued to the prisoner, pursuant to the Geneva Convention (relative to the treatment of Prisoners of War) of 12 August 1949, should not be

taken from him or her. Badges of rank and nationality, decorations, and articles having a personal or sentimental value should not be taken from prisoners of war. Sums of money carried by prisoners of war should not be taken from them except by order of an officer and only after the amount and particulars of the owner have been recorded in a special register and an itemized receipt has been given, legibly inscribed with the name, rank, and unit of the person issuing the receipt. Articles of value may be taken from prisoners only for reasons of security; and when such articles are taken away, the procedure for impounding sums of money should apply.

The Personnel Officer should maintain a list of qualified interpreters aboard.

The Photographic Officer should provide photographs of all prisoners of war as requested by the Commanding Officer of the Marine Detachment.

The CMAA should provide suitable storage for personal gear, other than valuables, removed from prisoners, and delivered to his or her custody.

PROCEDURES

Upon being taken, prisoners should be thoroughly searched and immediately delivered to the First Lieutenant/Commanding Officer of the Marine Detachment for safekeeping. He or she should then be charged with the primary administrative responsibility for ensuring compliance with the provisions of this bill.

Prisoners of war should be treated with humanity and should NOT be subjected to abuse, deprivation, or ridicule. They should be accorded their rights under existing treaties, conventions, and other valid provisions of International Law dealing with the treatment of prisoners of war.

Pending interrogation for intelligence purposes, if practical, no communication should be allowed between officer prisoners, noncommissioned officer prisoners, and their personnel. When possible, prisoners should be separated individually; or, if this is not possible, they should be separated by units, and such units or individuals should not be allowed to mingle at anytime.

Prisoners of war aboard a naval unit maybe required to disclose only their name, rank and serial number. They should be interrogated only by a designated, qualified officer and then only for information of a routine nature or when it is believed that the prisoners may volunteer information of immediate operational assistance. No physical torture, mental torture, or any other form of coercion should be inflicted on prisoners of war to secure information of any kind. Prisoners of war who refuse to answer should not be threatened, insulted, or exposed to unpleasant or disadvantageous treatment of any kind.

No member of the Armed Forces of the United States should be placed in confinement in immediate association with enemy prisoners or other foreign nationals not members of the Armed Forces of the United States.

For further guidance on procedures for prisoners of war. Refer to *Program for Prisoners of War and Other Detainees*, SECNAVINST 3461.3.

SUMMARY

In this chapter, we covered the duties of the CMAA and MA force aboard ship. Burial at sea and the control and inventory of personal effects were also discussed. Next, the evacuation of civilians was considered, followed by the procedures to be used when prisoners of war are taken.

CHAPTER 15

INVESTIGATIONS

This chapter contains general areas and investigative considerations essential to successful investigation and explains investigative jurisdiction as it applies to the U.S. Navy and other agencies with which you may come in contact.

INVESTIGATIVE JURISDICTION

LEARNING OBJECTIVES: Describe investigative jurisdiction and criminal offenses that must be investigated. Explain the difference between major and minor criminal offenses. Describe the function of command investigators, and identify security matters that require NCIS action. Identify the department responsible for personnel security investigations, and explain how requests for NCIS support are initiated. Describe the credentials and badges required for special agents.

Good order and discipline are the direct responsibility of the command. In the discharge of this responsibility, commanding officers frequently rely on prompt investigative action by professionally trained personnel. Those personnel are relied upon not only to effectively resolve alleged, suspected, or actual criminal and security offenses, but to preserve facts and construct an evidentiary foundation for subsequent command action. Under the Secretary of the Navy and the Director, Naval Criminal Investigative Service (NCIS) is the primary investigative and counterintelligence agency for the Department of the Navy. As a centrally directed organization, the NCIS provides support, as needed, both ashore and afloat, consistent with departmental policy and with full regard for individual constitutional rights. In a combat or combat contingency environment, the task force commander afloat and landing force commander ashore exercise immediate control over assigned Navy and Marine Corps investigative and counterintelligence assets. Commands maintain an investigative capability for the resolution of minor offenses and those of a purely military character, and have authority to commission fact-finding bodies to determine the circumstances of specific incidents.

INVESTIGATION OF CRIMES THAT VIOLATE MILITARY AND FEDERAL CRIMINAL LAW

The Secretary of Defense and the Attorney General recognize that the administration and discipline of the armed services require that certain offenses committed by military personnel be investigated by the armed services and prosecuted before military tribunals. They also recognize that other offenses committed by military personnel should be investigated by Federal authorities and prosecuted before Federal civil tribunals. It is obvious that inflexible rules are not feasible for determining the exact responsibility of military and Federal civil authorities where there is concurrent jurisdiction.

The following procedures make the investigation and prosecution of crimes more expeditious and efficient, meanwhile giving appropriate effect to the requirements of the Armed Forces and the policies of civil government. These procedures do not apply to the investigation of purely military offenses.

Whenever information is brought to the attention of a commanding officer indicating that a major crime has been committed on a naval installation, or a major crime involving naval personnel has been committed outside a naval installation, the commanding officer should furnish NCIS with this information and advise the officer who has general court-martial jurisdiction. If immediate response by the NCIS is not feasible, (such as when a submarine is on patrol or a ship is at a remote location), commanding officers should conduct such preliminary investigation as circumstances dictate, preparatory to later full investigation by the NCIS. Appropriate measures should be taken to ensure the preservation and accounting of possible evidence and to avoid any action that might prejudice investigative possibilities or otherwise impair the subsequent process of justice. It is the responsibility of NCIS to determine whether an investigation should be referred to the Federal Bureau of Investigation (FBI) or to other Federal, state, or local law enforcement agencies.

When it appears that the crime involves fraud against the Government (misappropriation, robbery, or larceny of Government property or funds), NCIS

immediately advises the FBI. NCIS will, however, conduct the investigation or refer it to other appropriate naval authorities unless promptly notified by the Department of Justice that it desires the FBI to assume investigative jurisdiction.

MAJOR CRIMINAL OFFENSES

The NCIS is the agency within the Department of the Navy responsible for the investigation of actual, suspected, or alleged major criminal offenses committed against a person, the United States Government or its property, and certain classes of private property, including attempt or conspiracy to commit such offenses. A major criminal offense is defined as one punishable under the UCMJ by confinement for a term of more than 1 year, or similarly framed by Federal statutes, state, local, or foreign laws. Incidents of actual, suspected, or alleged major criminal offenses coming to command attention (with the exception of those which are purely military in nature) are immediately referred to the NCIS. It is not normal to request investigation of only (a) specific phase(s) of a serious incident.

The Director, Naval Criminal Investigative Service, or field representatives may decline to undertake investigation of any case that in their judgment would be fruitless and unproductive.

In addition to referral of major criminal offenses, when any of the following circumstances occur, commands should promptly provide available information to the NCIS for preliminary inquiry to determine if a request for full investigation is warranted:

1. Unattended death of military personnel, dependents, or Department of the Navy employees occurring on a Navy or Marine Corps installation when criminal casualty cannot be firmly excluded.
2. Any fire or explosion of questionable origin affecting Department of the Navy property or property under Navy or Marine Corps control.
3. When a possibility exists that one or more elements of a major criminal offense may attach to an incident apparently minor in nature. An example would be a petty larceny within a barracks cubicle or stateroom wherein entry to effect the larceny may constitute the additional offense of housebreaking.
4. When aspects surrounding a nominally minor incident are of a potentially sensitive nature. Such considerations might include, but are not limited to, incidents involving ordnance, narcotics, dangerous

drugs or controlled substances, incidents of perverted sexual behavior, or damage to Government property which appears to be the result of arson or other deliberate attempt.

5. Thefts of personal property when ordnance, contraband, or controlled substances or items of a single or aggregate value of \$500 or more are involved, or when substantive issues of morale and discipline apply, such as a continuing series of unresolved personal thefts.

A major criminal offense may constitute a violation of both military and civil law and may involve both military personnel and civilians. Sole and concurrent jurisdiction may also rest with another agency outside the Department of the Navy. As previously mentioned, the NCIS is responsible for making investigative referrals in behalf of the command in these instances.

Certain instances will occur that may be resolved administratively without the application of professional investigative techniques. Within this interpretation are matters without criminal basis that might be resolved by a fact-finding body, an informal inquiry, or administrative audit. Incidents that fall into this category might result from accident, negligence, incompetency, improper accounting procedures, or intervention of the forces of nature.

MINOR CRIMINAL OFFENSES

A minor criminal offense is defined as one punishable under the UCMJ by confinement of 1 year or less, or carrying similar punishment by Federal, state, local, or foreign statute and lacking any of the considerations listed in the previous discussion of major criminal offenses.

COMMAND INVESTIGATORS

Certain Navy and Marine Corps commands maintain investigative personnel within Master-at-Arms forces, military police, base police, security or guard forces, shore patrol, provost marshals, and other compositions. Use of these investigators for criminal and security investigations is limited to minor criminal offenses, and those of a purely military character when the offense involves only Navy or Marine Corps personnel or dependents, and the investigation is confined to a ship or station. Off-base investigative activities, with the exception of normal liaison with local law-enforcement agencies, are restricted to a minimum and to the immediate area surrounding the installation.

This policy does not in any way restrict the discharge of assigned police and law enforcement functions by authorized personnel or their responsibilities to execute appropriate procedures on suspicion or discovery of any criminal offense, such as preventing the escape or loss of identity of suspected offenders, preserving crime scenes and the integrity of physical evidence, effecting preliminary on-scene inquiries, investigative assistance under the operational direction of the Naval Criminal Investigative Service, or any other actions that, in the judgment of the responsible commander, are necessary for the immediate preservation of good order and discipline.

Command investigators will be recommended by the security officer for appointment by the commanding officer. Persons who are selected must have received formal training (NEC 2002) and/or be experienced to such a degree that the integrity of investigations will not be compromised and will lead to successful prosecution.

SECURITY AND COUNTERINTELLIGENCE MATTERS

Departmental agreements between Defense and Justice in part implement a Presidential directive that, for the NCIS, establishes exclusive investigative jurisdiction within the Department of the Navy in matters involving actual, potential, or suspected sabotage, espionage, and subversive activities. This is considered to include actual, suspected, or attempted defection. Command referral of matters in these categories to the NCIS is mandatory.

Security matters requiring utilization of the NCIS include the following:

1. Loss, compromise, leakage, or unauthorized disclosure of classified information, when appropriate, in accordance with OPNAVINST 5510.1.
2. Unauthorized attempts to obtain classified or other information of intelligence value from Navy and Marine Corps personnel.
3. Security situations that lend themselves to resolution through the application of counterintelligence operational techniques and counterintelligence studies and analysis of groups or organizations whose interests are inimical to those of the United States, whose actions are targeted against the Navy and represent a clear threat to security. See DOD Directive 5705.42, *Defense Investigative Service (DIS)*.

PERSONNEL SECURITY INVESTIGATIONS

The Defense Investigative Service (DIS) is a separate operating agency of the Department of Defense and provides for the conduct of personnel security investigations (PSIs) for DOD components. The DIS performs this function within the 50 states, the District of Columbia, and the Commonwealth of Puerto Rico. The NCIS accomplishes PSIs on behalf of the DIS in other areas and has responsibility for investigative development of matters resulting from personnel security investigations that have a significant counterintelligence or criminal aspect.

INITIATION AND REPORTING OF INVESTIGATIONS

Requests for NCIS support maybe initiated by any commander, commanding officer, or other appropriate command authority in the Navy and Marine Corps, to the nearest NCIS representative. The NCIS is authorized, exclusive of command request, to undertake activities in matters of sabotage, espionage, and subversive activity; and to support on a reciprocal basis other Federal, state, local, or foreign law enforcement, security, or intelligence agencies. Separate from the foregoing, the Director, Naval Criminal Investigative Service and representatives specifically designated by the director are authorized to initiate preliminary investigative action without a specific request in any category of case under NCIS investigative jurisdiction when urgent or unusual circumstances exist.

The NCIS maintains technical specialists qualified to assist commands in their development of a comprehensive audio security posture through the application of technical surveillance countermeasures techniques. (See OPNAVINST C5500.46.)

With the exception of those offenses that are purely military in nature or relate to routine traffic violations, copies of all reports of complaint and investigation by command criminal investigative and security personnel and base police are furnished to the local NCIS representative.

The NCIS will provide a full report of each investigation conducted on behalf of the requesting authority.

The NCIS maintains a central repository for appropriate reports of investigation and pertinent counterintelligence data and provides statistical data on investigative and other matters within its mission responsibility.

CREDENTIALS AND BADGES

Individuals accredited by the Director, Naval Criminal Investigative Service, to carry out investigations and other mission-related responsibilities are issued standardized credentials and badges designating them "Special Agents." Certain personnel are also issued credentials identifying them as "NCIS Representatives." No other persons in the Navy and Marine Corps engaged in investigative, security, or counterintelligence matters are authorized to use these titles. Personnel issued NCIS Special Agent and Representative credentials are cleared for access up to and including Top Secret by the Director, Naval Criminal Investigative Service. They are presumed to have a "need to know" with regard to access to information, material, or spaces relevant to the performance of their official duties. Access to special intelligence and compartmented or similarly controlled spaces, material, or information is cleared by the authority controlling access before the Special Agent or Representative pursues a matter of official concern. NCIS Special Agent and Representative credentials are to be accorded full recognition when presented on entering or leaving installations. Accredited NCIS personnel, vehicles used by them in the course of official business, and all occupants therein are exempt from routine search.

Properly designated personnel assigned to naval security forces, shore patrol, or other activities as command investigators, will carry a Department of the Navy Command Investigator ID

Card (OPNAV 5527/26) signed by the commanding officer. See figure 15-1. Command investigators who are required by their commanding officer to carry badges should use those badges displayed in *U.S. Navy Uniform Regulations*, upon which appropriate wording should be engraved (for example, Security Investigator, Command Investigator, S.P. Investigator, MA Investigator).

CRIMINAL INFORMATION AND INTELLIGENCE OPERATIONS

LEARNING OBJECTIVES: Define the types of criminal information and the responsibilities at the various levels of command. Describe the criminal information process and the system of records and laws.

The successful conduct of law enforcement investigations relies upon the acquisition, processing, and application of certain essential information. Criminal information is a part of police intelligence and as such contributes to the overall Navy intelligence function. The value of criminal information cannot be overemphasized. It not only serves the purposes of investigators but also contributes to the needs of the commander in administering command functions.

DEFINITIONS

Now let's look at the types of criminal information and their definitions.

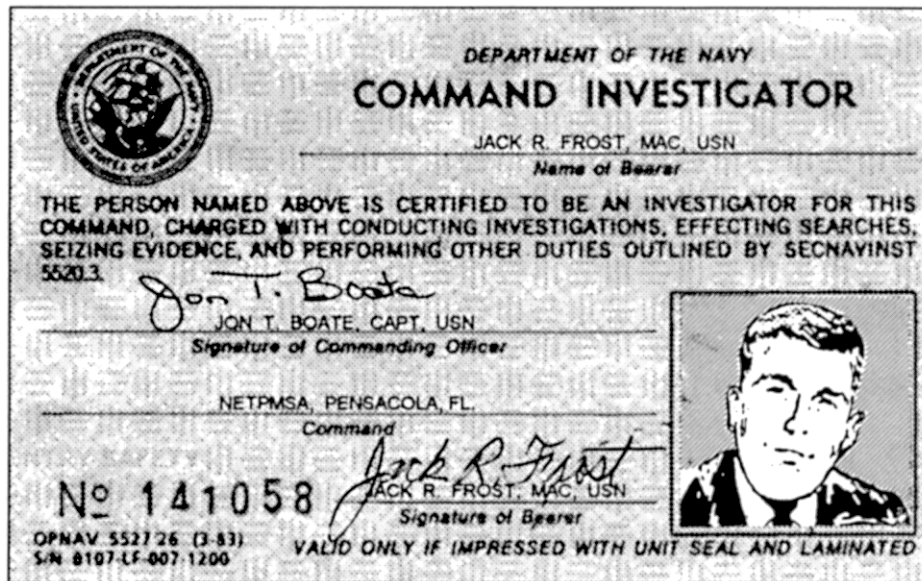

Figure 15-1.—Navy command investigator ID card.

Police information– Processed information relating to criminal activities, police law enforcement and security operations, and incidents that disrupt law and order.

Criminal information– A category of police information applying to criminal activities, violation of criminal law, and crime prevention. Criminal information applies to acts of crime committed by individuals or organized criminal groups–crimes that affect the discipline, law, and order within the U.S. Navy.

Operational information– A category of police information required for planning and executing police law enforcement and security operations.

Source of information– Any person, object, or recorded data from which law enforcement personnel obtain information that may be of investigative assistance.

Essential elements of criminal information (EECI)– Critics items of information pertaining to criminal activities and crime areas that, when related with other available information, provide the investigator or investigating agency the information for reaching conclusions and making decisions. Essential elements of criminal information provide guidelines for the collection of information to assure critical items of information are collected, processed, and disseminated to the appropriate user.

Other criminal information requirements (OCIR)– Additional information requirements that are useful to the collection effort but not immediately essential.

Criminal intelligence operations– Those formalized programs regarding significant criminal activity targeted against or directly involving Navy and Marine Corps personnel to gain information of a criminal intelligence nature for law enforcement purposes.

RESPONSIBILITIES

A high degree of specialized training and experience is mandatory to the successful accomplishment of criminal intelligence operations and, to the extent that they are undertaken within the Department of the Navy, the operations are done exclusively by the NCIS, regardless of location. Criminal intelligence operations are undertaken at NCIS initiative, in close coordination with senior command authority. During their course, these sensitive operations

may cover wide geographic areas and extend across multiple command lines.

All Department of Defense investigative records are indexed within the Defense Criminal Investigative Index (DCII). There are four major contributors to the DCII. These are the Army, Navy-Marine Corps, Air Force, and the DIS. The purpose of the DCII is to reveal past investigative activity involving any subject of an investigation. The NCIS is the contact point for command investigators requesting inquiries to the DCII.

The local command investigators collect criminal information at the local level and may evaluate it for their own purposes, sharing it with other military agencies in the investigative effort. They must also develop sources of information, provide input to the criminal information system, and apply criminal information to investigations.

CRIMINAL INFORMATION PROCESS

The criminal information process is a continuous cycle of interrelated activities directed toward converting raw information into material useful for law enforcement purposes.

Normally, the criminal information process described here is carried on in a large-scale operation. However, for MAs and command investigators, the process may be well-applied at a local level.

There are six steps in the criminal operation process, as follows:

1. Planning and Collecting. Planning for collection of information is needed at all levels. Short-, medium-, and long-range requirements should be established.

Priority areas of interest, expressed in the EECI and OCIR, are required due to resource limitations. They are not permanent, and the areas of interest will vary. Subordinate commands support the EECI and OCIR of higher commands and may establish their own priorities to meet local needs.

The individual investigator is the key to a successful collection effort. During daily activities, the investigator should look for information as specified in EECI and OCIR. The collection effort is continuous and should be aggressively pursued to be effective. Though priority will be placed on EECI requirements, the collection of other useful criminal information must be emphasized.

Available sources of information are unlimited as long as they are energetically used. Historically, the

police have relied upon people and other agencies for information. Informants have always supplied an important part of the information received.

2. Evaluating Criminal Information. The evaluation of criminal information involves determining the reliability of the source and the accuracy and pertinency of the information.

The individual investigator collecting the information is best able to judge the reliability of the source, particularly when it comes from informants. This determination is dependent upon past experience with the source. This evaluation of the information's accuracy and pertinency is best determined by the individual investigator and the local police operation.

Information processed by higher levels is evaluated in relation to other known information and prevailing circumstances. Information corroborated with other sources will generally be evaluated as more accurate.

3. Analysis. Analysis of information is conducted at all levels of the criminal information collection activity. The best basis on which to conduct analysis is experience. Additionally, the information may be subjected to various types of analyses (such as statistical analysis, operations research, systems analysis, and computer analysis).

Information is analyzed by itself before it is integrated with other information, to determine its value and to identify significant elements. It is then combined with other information. Analysis is the asking, "What significance does this information have? What does it mean?"

4. Collation. Collation is combining information with related information. This allows examination of all available information and presents the greatest possibility of deriving sound theory and judgments.

5. Reporting. Reports of criminal information may be as brief or as complex as is necessary. The reports should be tailored to the needs of the principal user and objectively prepared so the user can make sound decisions when using the information. Reports should be logically and concisely prepared and show what is positive information and what information is inferred or theory.

6. Dissemination. Criminal information is useless unless placed where it can be used. Dissemination of information should be made to law enforcement and command channels when required. The information should be valid. However, strict control should be used in the entire information process. For these reasons,

various records should be maintained, and certain restrictions should be followed in disseminating.

SYSTEMS OF RECORDS

The Privacy Act of 1974 requires that a public notice be published in the *Federal Register* for each system of records before it becomes operational; that is, before any information about individuals is collected for indexing into it. Each "routine use" of a system of records must have been established in a notice published for public comment at least 30 days prior to disclosure of a record for that "routine use." *Personal Privacy and Rights of Individuals Regarding Records Pertaining to Themselves*, SECNAVINST 5211.5, contains detailed guidance on the formats to be used by agencies in publishing their public notices. An agency should identify in its system all categories of its records; for example, reports of investigation, name index file cards, informant card file, modus operandi file. There are no built-in or automatic exemptions or exclusions, even for such categories of records as informant registers.

LAWS

The Privacy Act of 1974 provides for individuals to have access to their personal records, with certain limited exceptions—most notably for records collected for law enforcement purposes. SECNAVINST 5211.5, which implements the Privacy Act of 1974 and DOD Directive 5400.11 for the Department of the Navy, delineates policies, conditions, and procedures that govern collecting personal information; and safeguarding, amending, and disseminating personal information kept by the Department of the Navy in a system of records. Except for a systems-wide exemption of properly classified material, a system of records carries only those exemptions expressly authorized for it by the Secretary of the Navy and duly published. Even though an exemption maybe permitted, in keeping with the spirit and intent of the Privacy Act of 1974, information from individuals' records will be released to them unless significant and legitimate governmental purposes exist for withholding them.

The Freedom of Information Act applies more broadly to persons seeking many kinds of records, not just their own. It is the principal law of openness in the Government. Access by individuals to their own files (see SECNAVINST 5211.5), falls under the provisions of the Privacy Act of 1974, regardless of whether either, both, or neither Act is invoked. Further, one Act may not

be used as a basis for denying that which would be available under the other.

Each command should have a designated information and privacy coordinator, whose principal functions areas follows:

1. To act as the local point of contact for implementing and administering the privacy program within its jurisdictional area.
2. To ensure that the published system of records describes those personal records retained by components within the command.
3. To ensure that disclosure of personal information and accounting records are made in accordance with SECNAVINST 5211.5.
4. To provide proper and continuing training of personnel connected in any way with personal records systems.

Denial of information can be made only by designated denial authorities. For further discussion on denial, see paragraph 4.c. of SECNAVINST 5211.5.

The requirement to inform individuals verbally and in writing of the purpose to which the collecting agency intends to put personal information collected about them does not apply for that information collected for law enforcement purposes, if first authorized by the Secretary of the Navy. For discussion see paragraph 9.b. of SECNAVINST 5211.5.

Disclosures of information from a system of records must be consistent with the disclosure provisions of the Privacy Act of 1974 at 5 U.S.C. 552a(b), and with the "routine uses" established by the agency in its system of records. It is a requirement that a written account of all disclosures made outside the Department of Defense be kept with an individual's file. An agency's "routine uses" must specify intended use of its information to state, local, and foreign investigative, criminal investigative, and intelligence agencies for law enforcement and mutual protection/security purposes for such disclosure of information to be legal.

An individual may not be denied a right, privilege, or benefit because of refusal to disclose his or her social security number (SSN) unless such disclosure is required by Federal statute or required by a system of records in existence and operating before 1 January 1975. The Department of the Navy is authorized by Executive Order 9397 to use the SSN as a system of numerical identification of individuals. For discussion,

see paragraph 9.c. of SECNAVINST 5211.5 and section 7 of the Privacy Act of 1974.

INFORMANTS

LEARNING OBJECTIVES: Explain the importance of informants in the investigative process. Describe the selection of informants and list the various motives of informants. Describe the management and control of informants and the techniques used with members of the opposite sex and juveniles. Determine the appropriate meeting places with informants and explain how informants should be treated. Discuss the legal status of informant information with regard to various court decisions.

Criminal acts, when carried out in ways that afford the most concealment, often provide little in the way of tangible leads for the investigator. By the time MA or command investigators arrive at the crime scene, the suspect has usually disappeared. Physical evidence is examined during the course of an investigation. By itself, the physical evidence gathered seldom identifies the perpetrator. Often, physical evidence will only place the suspect at the crime scene once he or she has been brought under suspicion.

Like physical evidence, people are a source of information, and probably the more important of the two. In addition to the victim and witnesses, an informant could be a valuable source of information for the investigator. The informant is often the most direct and fastest contact with criminal elements, and might provide information in a few minutes that would otherwise require an extensive investigation to uncover.

The requirements for the management of informants by Navy security force personnel are contained in chapter 16 of the *Navy Law Enforcement Manual*, OPNAVINST 5580.1.

SELECTION OF INFORMANTS

People seek social contacts with others, are curious about those around them, and note conditions unfamiliar to them. Feelings of suspicion are based on such observations. Many criminals have been apprehended just because something did not seem right to the investigator.

People seek recognition for their deeds and are prone to pass on rumors about the deeds of others. This

trait makes complete secrecy difficult. It also creates the situation in which, if informants are properly handled, criminal exploits can come to light.

All people can be sources of information, and in the broad sense of the term, can be referred to as informants. A partial listing of those within the military community who can provide information that could enhance an investigation includes unit mail clerks, medical personnel, club or mess employees, public works maintenance personnel, newspaper carriers, base telephone personnel, and custodial personnel.

During the selection process, due consideration should be given to the informant's health (mental and physical), age, education, personality traits, experience or employment history, financial status, and criminal background. Failure to consider the whole person can result in wasted time and money.

Perhaps the most important consideration is an informant's reliability. All new information is verified through other reliable sources or, when an informant's reliability is being tested information known to and controlled by the investigator is solicited from the informant being evaluated. This procedure enables the investigator to assign a tentative degree of reliability to individual informants.

An informant's status is never viewed as a license for present or future misconduct. It is not only unethical, but also illegal (Art. 77, 78, 81, MCM), for any investigator or agency to establish a protective allegiance with those who have complicity in a criminal act.

MOTIVES OF INFORMANTS

The use of informants has often been criticized on moral and ethical grounds. The public tends to believe that law enforcement personnel condone and actually protect the criminal activity of an informant in return for his or her services. The informant is willing to furnish information for one or more of a number of reasons, none of which involves protection.

The investigator has the responsibility for evaluating the informant and the information given to arrive at the facts. Thus, the informant's motivation is important, and the investigator should attempt to determine what motivates each informant.

The Fear Motive

Self-preservation is the first law of nature. It might be expected, therefore, that an emotional reaction

favorable to the investigative effort could result when a prospective informant is afraid of something. It could be a fear of the law or its enforcers.

For example:

SN Boate is apprehended during the commission of a commissary warehouse larceny. Two accomplices escaped at the approach of the security patrol that apprehended Boate. This larceny attempt was the third such theft in the last month, and each of the previous larcenies showed a similar modus operandi.

It is one of the practical facts of law enforcement that under such conditions the accused looking for sympathy, extenuation, mitigation or whatever they think might improve their lot, are often disposed to give a full account, or at least some account, of their crimes or those committed by others within their knowledge. The informant thereby may furnish the investigator with direct evidence against other criminals or show how such evidence might be obtained.

Where such disclosures involve higher-ups or implicate others, this sort of development is very much to the advantage of law enforcement personnel. The practical effect in the police-informant relationship in this situation is a matter to be considered in mitigation before sentencing takes place.

One point must be stressed—a suspect undercharges cannot be expected to produce information simply because he or she has been apprehended

When the information is not forthcoming, it must not be supposed that the suspect does not have information or, that possessing it, is not willing to furnish it to the investigator. If information is to be obtained under these circumstances, the suspect must feel that such information will be welcomed and that the investigator will do whatever can be done to protect the informant from disclosure that he or she is the source of information.

The fear motive is not necessarily restricted to a fear of the law or its consequences.

It happens on occasion that an informant is a criminal who fears those associates who can, in the informant's opinion, mete out a more drastic form of punishment than military law. The informant, then, may be a frightened person who sees in the forces of the law the lesser of two evils.

Revenge Motives

Revenge may overwhelm the informant with an all-consuming desire for retaliation. That retaliation can take the form of disclosure of information to the authorities. It may arise again from a lack of honor among thieves. Sometimes it may come only from a feeling by a member of a criminal group that the member is being discriminated against or is not given the preferential treatment or opportunity to which that person is entitled. A desire for revenge sometimes arises from factors independent of criminal activities. Jealousies and quarrels over women or men can cause the closest of friends to become bitter enemies.

Perverse Motives

In this category are those motives of the informant who makes a disclosure in the hope of gaining some unusual advantage. An example of this type of informant is one who provides information on others engaged in a similar criminal activity to reduce the competition. In this category also are the operations of criminals who give worthless or trivial information, hoping that it will stimulate a reaction on the part of the investigator that will disclose the extent of police knowledge about the informant's activities. In this class also is the criminal who sees that law enforcement personnel receive false and misleading information, which might tend to divert suspicion from the informant's activities.

Egotistical Motives

A common characteristic of humanity seems to be that people take pleasure in spreading news to interested listeners. The petty offender who can enlist the undivided interest of an investigator with a meaty story gets a real kick out of the operation. The informant's ego is particularly enhanced if, by giving bits of information on the criminal activities of more notorious offenders, his or her importance is magnified.

Because the informant who is egotistically motivated often has a tendency to prattle, the investigator must be willing to listen to everything the informant has to say, or the investigator runs the risk of ignoring what might prove to be very valuable information.

Mercenary Motives

This type of informant provides information for the sole purpose of financial gain. The informant's interest is to sell information for the highest price. The

information obtained from this informant is generally good; however, it can backfire if sold to a higher bidder or if it purposely misleads to sabotage the police effort.

Reform Motive

Occasionally, an informant will come to the authorities to repent wrongdoing because of a desire to make restitution, or to break with criminal elements. Although infrequently encountered, this type of informant can provide valuable information and, when properly managed, can become an excellent continuing source of police information.

Gratitude

A skillful investigator can develop a sense of gratitude in potential informants. Using this, the informant may wish to express appreciation by furnishing police information in return for the investigator's providing certain ethical assistance. A mere concern for the welfare of the informant may create this sense of gratitude.

Demented, Eccentric, or Nuisance Motives

A few people provide information because of a peculiar quirk in their personality. Generally, such informants are more of a bother than they are of value. However, they should never be cut short—each should be given the opportunity to tell his or her story, and it should be checked out. There may always be that one chance that the information given will provide the missing link in an important case.

INFORMANT MANAGEMENT

Occasional allegations of unethical, immoral, and possibly illegal arrangements between investigators and informants underline the need for effective police management of the informant. Additionally, it must be remembered that the individual investigator is an agent of the Government and does not "own" the informant.

Traditionally, the identity of an informant was known only by the individual investigator with whom he or she worked. But if the investigator happened to be assigned to other cases, then the value of the informant was lost.

The identity of the informant should be maintained in one central file. Identity should be kept confidential, and complete security of this file should be maintained. Only the investigator's superior should have access to

this central file, and only on a need-to-know basis. This file should contain all the information known about the informant.

Each dossier should contain the results of a discreet inquiry into the informant's background, including occupation, associates, income, and criminal record, if applicable. Pertinent background data, such as general attitude toward assisting the police, known idiosyncrasies, and suggested time and place of contacts should be included.

Within the file, a record of all transactions with the informant should be maintained, including a resume' of cases worked on and an up-to-date evaluation of the informant's reliability. A constant effort should be made to keep the file current. This will help ensure that a valuable informant is not lost to the investigating unit.

The informant should be assigned a code name or number, and that name should appear in all reports. A cross-reference file is useful, but it should be maintained with the same degree of security as the master file. The informant's name should never appear outside the master file.

An informant locator file can be maintained apart from the master file if it eases operations and does not merely create work. This file should be indexed by different classifications such as the informant's associates, connections, operation, and area in which operated. It also should be available to other investigators.

Through the use of this locator file, it can be determined if an informant is available in a particular field of inquiry. When an investigator locates an informant in the locator file, a request is made for contacting arrangements. In this way, greater use is made of an informant's knowledge without compromising his or her identity.

If it is known that a person is informing for another investigator, it is unwise to mention that to the informant in a casual encounter. Security is the paramount consideration in the continued use of a person furnishing information.

An informant program should be expertly handled to preserve the integrity of the investigating unit and to ensure the safety of the informant. The program should be developed and operated to effect maximum use of the informant for the benefit of the entire agency. It should be strongly supervised and based upon legal and ethical prescriptions.

INFORMANT CONTROL

An individual member of the investigative unit and one alternate should be assigned to each informant. Ideally, the investigator who first developed the informant should be assigned to him or her. All contacts with this informant should be made by the assigned investigator, even when it is the investigator's only role in the case. The alternate investigator can become acquainted with the informant by occasionally accompanying the investigator assigned to the informant when contacting the informant. The alternate investigator will facilitate the necessary contacts at some future time if the regularly assigned investigator is not available.

The value of having one investigator call upon the informant is to avoid repetitive demands on the informant's time and to circumvent personality conflicts. One investigator making all of the contacts, being fully aware of the pitfalls that may be encountered, will expeditiously and economically keep relations on an even keel, and will actually attain much more cooperation than could otherwise be gained.

One of the principal responsibilities as a control investigator is to evaluate the informant and estimate reliability. The information received should be tested for consistency by checking against the information obtained from other sources. The motives and interests of the informant should always be considered in the evaluation.

INVESTIGATOR COMPROMISE BY INFORMANTS

Informants come from all walks of life and are often opportunity motivated. The investigator must never allow an informant to compromise his or her integrity or the integrity of the investigation with claims of sexual misconduct. Meetings with informants of the opposite sex should be conducted in a public setting or at least within sight and sound of other people. If the nature of the investigation and/or the confidentiality of the informant dictates, meetings may be more clandestine. In this event, the meeting should be attended by two investigators. This procedure should be followed anytime the investigator believes an informant may make claims of misconduct.

JUVENILE INFORMANTS

Society has placed juveniles in a special category. The civilian criminal justice system provides for

juvenile courts, special recordkeeping procedures, youth detention centers, and the like. It follows, therefore, that juvenile informants require special handling.

Common sense, coupled with a strict adherence to the requirements of military law, guides the investigator in dealing with juvenile informants to ensure they are not abused or taken advantage of.

MEETING WITH INFORMANTS

The selection of a meeting place, on each occasion, should be made by the control investigator and not by the informant. The location and time should vary with due consideration to both the investigator's and the informant's normal routines.

There may be occasions when contacting the informant directly is undesirable. An unlisted telephone in the investigator's office is useful in this situation. When you answer such a telephone, simply say "hello" and not "Investigations, Investigator Jones speaking." If pressed for more information by an unknown party, repeat the telephone number but provide no further comment.

Other methods of contacting the informant may also call for guarded or unguarded letter drops, or the mail. Always prepare an informant with a cover story in the event he or she is observed in the company of the control investigator. The cover story should be simple and acceptable to any casual observer. Careful judgment in communicating will avoid revealing the status of the informant.

Meetings should be held at a place other than the investigator's office and should be planned so as not to create a recognizable pattern.

The informant's identity should not be revealed in any communications.

TREATMENT OF INFORMANTS

The treatment of informants is a delicate matter because of the variety of motivations present. Each informant will be different, and treatment of each must differ accordingly. However, certain rules are applicable:

Avoid the use of derogatory terms. An investigator may be working with unscrupulous or despicable persons. To some, the label "informant" may conjure up many derogatory connotations, such as *stool pigeon*, *traitor*, *double-crosser*, *rat*, *fink*, and *squealer*. It should

be obvious that these terms have no place in the police-informant relationship. Any informal use of such derogatory words will endanger rapport.

One of the most compelling deterrents against informing is the hatred that can come from other people. Although the investigator may have some similar feelings, the language used should not reveal this attitude. Substitute a term like *source* or some other similar term.

Express appreciation by encouraging and complimenting the informant for all information received, regardless of its value. A conversation often starts out, "I don't know if this is worth anything, but . . ." only to turn out to be the information being sought. Encouragement should not be interpreted to permit an informant to take charge of any phase of the investigation, although some informants will try it, intentionally or not. The investigator should not share investigative information with the informant. Revealing information will establish a susceptibility to double-cross.

Make good all promises and make no promises that cannot be kept. Do not promise the informant that he or she will not go on trial for certain crimes. The investigator can, however, make good a promise to notify the trial counsel of the informant's cooperation in aiding the investigative effort. The investigator must be scrupulous in the fulfillment of all promises made. Any other policy will result in a lack of trust and the loss of the informant, to say nothing of the investigator's self-respect.

There are many guides to remember when dealing with an informant, such as keeping appointments on time, even though the informant may not appear. Don't become anxious. Be patient. Investigate all leads. The fact that a previous tip was of no value after investigation should not be cause for automatically discounting other tips. Be noncommittal about the value of the information received. Consider all information from informants as valuable until proven otherwise.

LEGAL STATUS OF INFORMANT INFORMATION

Generally, military courts will treat informant information as hearsay and evaluate it for reliability in making probable-cause determinations, as in an application for a search warrant. If it can be established that the hearsay information is reliable and credible, the court can accept it under certain conditions.

In contrast, if the court is skeptical about the informant's reliability, it may reject the information. The court will look at the source of the information. If it is from reputable citizens (public officials or informants with a history of reliability), it will carry more weight than if it is from anonymous phone calls, known criminals, or informants whose reliability is questioned or unknown. The court will also evaluate information in terms of the corroboration made by comparing the specific allegations with the circumstances and events.

A guiding case that demonstrates conscientious efforts to corroborate information is found in *Draper v. United States*, 358 U.S. 307 (1959).

A reliable informant identified the defendant to the police by physical appearance (skin complexion, height, weight, size, sex), and dress (color and type of coat and hat), as well as what he would be carrying (black satchel with narcotics), and stated which train he would be on. The policemen met the train and observed the defendant, exactly as described, get off the train. They apprehended Draper and recovered the narcotics in the black satchel.

The U.S. Supreme Court found that the events observed by the policemen substantially corroborated the information. The Supreme Court held the apprehension to be lawful and the search for narcotics incidental to a lawful apprehension.

The Supreme Court in *McCray*, 386 U.S. 1042 (1967) strengthened the Draper ruling. Policemen who make apprehensions based on information furnished by a reliable informant and are able to establish past reliability or independently corroborate the information ordinarily need not disclose the informant's identity, and the apprehension will be lawful.

The informant's background and source of knowledge are essential in evaluating information. The Supreme Court held in *Aguilar v. Texas*, 378 U.S. 108 (1964), that it was insufficient for the policeman to simply tell the judge in an application for a search warrant that the informant had previously proved to be reliable or that the policeman knew the informant was reliable. That affidavit was inadequate because, first, the underlying circumstances necessary to enable the magistrate to independently judge the validity of the information were not set forth and, second, the policeman did not attempt to support the claim that the informant was credible or the information reliable.

The Supreme Court held in *Spinelli v. United States*, 393 U.S. (1969), that when corroboration of the informant's tip did not provide more than mere suspicion that a crime was probably being committed,

then the information was insufficient. Further, that a simple assertion of suspicion that Spinelli was a known gambler was not itself a sufficient basis. The court's main concern was not that the information was so insubstantial, but rather that it needed further support. In the Spinelli case, the affidavit fell short of the standards set forth in *Aguilar* and *Draper*. The court further stated it was not retreating from the established proposition that only the probability and not the prima facie showing of criminal activity was the standard of probable cause. However, the unsupported assertion or belief of the policeman did not satisfy the requirement of probable cause.

In *United States v. Barton*, II J.J. 230 (CMA 1981), the court stated that the reliability of informants could be established in various ways and was not restricted to establishing previous reliability in terms of apprehensions, convictions, and so forth. In that instance, the police established reliability by obtaining information separately from two informants, and the interlocking of details in the two accounts established probable cause.

As a general rule, the trial counsel has the privilege of withholding the identity of persons who have furnished information. However, in situations where no corroboration or reliability of the information is established, the informant's identity may have to be revealed. The case may have to be dropped rather than have the informant testify in court. Unless there is a previous agreement regarding the court appearance, an informant should not ordinarily be required to appear in court.

If the informant has done more than merely provide a lead, then it may be shown that he or she is a material witness whose testimony would be of value to the defense. The informant's testimony would be relevant to the accused's defense and essential to a fair determination of the case if the informant participated in the crime, assisted in planning the crime, or was involved in some overt act encompassed by the crime. If the informant aided in the actual investigation by accompanying the investigator to the crime scene, or helped with a surveillance, observed the crime, or was present when the defendant was arrested, the informant's importance to the defense must be recognized. (See rule 507, Military Rules of Evidence, *Manual for Courts-Martial*, 1984 (rev).)

OBSERVATION, DESCRIPTION, AND IDENTIFICATION

LEARNING OBJECTIVES: Explain the meaning of *observation*, and describe the techniques used in observation and description. Explain the importance of accurately evaluating the data provided by witnesses. Describe the techniques that should be used for a lineup.

In police work *observation* means perception of details pertaining to persons, objects, plans, and events through the use of the five senses. An investigator makes *descriptions* to convey to others his or her own observations or the observations of witnesses as reported to the investigator. Identification by a witness or victim is the art of establishing the relationship of a person, place, object, or event to an incident or offense.

Further information on methods and techniques used for observation, description, and identification can be found in the *Navy Law Enforcement Manual*, OPNAVINST 5580.1.

OBSERVATION TECHNIQUES

As observation techniques are accomplished through the use of the five senses, sight and hearing are relied upon most often. The senses of taste, smell, and touch may occasionally be used advantageously.

The investigator must be able to observe accurately to recognize infractions of the law, persons, and objects of interest to law enforcement and crime prevention programs. Keen observation is necessary to perceive investigative leads, to evaluate the validity of statements by witnesses, and to make accurate reports. The ability to observe accurately is developed through practice and experience.

It is essential that, as the investigator, you be aware of influences that tend to impede or otherwise affect observation. You need to be able to recognize and compensate for those elements and factors that may detract from your ability or the ability of others to observe accurately.

Events or remarks that are meaningless when seen or overheard by the layman maybe of great significance to the trained and experienced investigator. To assist in remembering observations, you should make extensive use of photographs, sketches, notes, and other recording methods.

Persons

Diligently observe individuals either to be able to describe them or to identify them from descriptions made by others.

Deliberate observation should proceed methodically as follows:

First: General characteristics, such as sex, race, color of skin, height, build, weight, and age.

Second: Specific characteristics, such as color of hair and eyes, shape of head and face, distinguishing marks and scars, mannerisms, and habits.

Third: Changeable characteristics, such as clothing worn, use of cosmetics, hair styling, at time of observation.

When attempting to identify a person from a description, the pattern of observation maybe modified or even reversed, particularly if the individual sought has some very noticeable personal characteristic-for example, a man with a limp or a very tall woman.

After first noting such a characteristic, further observation of general characteristics (such as height, weight, and age) and additional specific characteristics may then complete the identification of the individual as the person being sought.

Objects

When observing physical objects for later description or to locate a previously described object, follow a pattern proceeding from general characteristics to specific characteristics.

The method of observation proceeds as follows:

1. General type of item, including size and color.
2. Specific distinguishing characteristics, such as a sun roof in an automobile, or a portable-type radio or typewriter.
3. Make and model designation, when applicable.
4. Distinguishing marks indicating damage or alteration, such as a broken headlight, a repainted fender, or a missing handle, or scratch on a piece of luggage.
5. Identifying number(s), marking(s), or label(s), when present.

Places

Detailed observation of specific places is usually made to establish the exact scene of an incident or crime, or to detect relevant evidence. The purpose may be to relate to an incident or crime such information as has been previously obtained from witnesses as the result of their observation of persons, objects, or events.

The basic pattern of observation may vary, depending on whether the place observed is in the open or inside a building or structure.

Outdoors. Most outdoor places observed either will contain or be relatively near natural or manmade landmarks that may be used to pinpoint the general location. Frequently, however, outdoor locales may not have well-defined boundaries or delimiting terrain features, such as roads, fences, streams, buildings, or wood lines. Consequently, you must develop the ability to mentally assign limits to the area to be observed. Such limits should preclude both overextension and illogical limiting of the area observed. A convenient procedure is to observe details such as the following:

1. General location and its proximity to such outstanding terrain features and landmarks as roadways, railways, streams, or shorelines.
2. Exact location in relation to specific fixed or semifixed features such as buildings, bridges, telephone and powerline poles, and pathways.
3. Outstanding objects or features within the scene.
4. Details of the scene and details of items of particular interest.

Indoors. The observation of indoor scenes is simplified by obvious and definite boundaries, such as the walls of a room, the area of a hallway or basement, or the confines of an apartment. On the other hand, indoor areas contain many specific objects, which can complicate the task of complete observation. Because of this latter aspect, it is particularly important in the case of indoor scenes that a methodical pattern of observation be used. Normal procedure is to determine the following, in order:

1. Location of the place to be observed including section of building in which located, such as front or rear, floor level, and so forth. Relationship to building entrances and distances to stairways, elevators, and so forth, should be noted.
2. Room number or other designation.

3. Details of immediate entrance(s) to the specific area of interest.

4. Objects located within the area. Use a clockwise or other methodical progression of observation from a designated initial point.

5. Exact location in relation to other objects of specific interest.

Events

In most instances, you are called to the scene after an incident has occurred or a crime has been committed, but seldom observe the complete event as it is occurring. However, your observation of connected actions after the event may supply major clues as to what has occurred.

Such a small, but often very significant action or circumstance as an inappropriate remark, a state of excitement, a sly gesture or glance, an expression of unusual curiosity, or an unlikely profession of lack of knowledge may often provide the trained observer with the necessary lead to develop an important aspect of an investigation.

Similarly, significant information may often be deduced from such details as the way a fire burns, the presence of certain fumes or odors, the pitch of a voice, or the warmth of a body. Such deduction may aid in the reconstruction of an event with respect to its cause or origin and its progression.

The ability to promptly recognize related collateral acts or conditions, and to interpret them correctly in the light of other circumstances to develop information of the main event as it occurred, is an investigative skill you need to develop carefully.

Facts to be determined concerning an event are the time of occurrence, location, sequence of action, objects and persons involved, and resultant factors.

If present when the event occurs, you must be able to observe objectively, accurately, and rapidly all essential factors of time, place, persons, objects, and actions involved, as well as the immediate results of the event. These factors are involved in the essential questions of when, where, who, what, and why.

The ability to accurately observe actions and events through using all five senses is a skill developed only through concentrated training and practice. Complete and accurate observation is the result of conscious, applied, effort rather than mere chance.

DESCRIPTION TECHNIQUES

Descriptions will normally be written or verbal, but may include signs, gestures, sketches, and other means of imparting information. It is essential that you be proficient in both written description (for report writing) and verbal description (for appearances as a witness in legal proceedings).

Persons

Every individual has some distinguishing characteristic or combination of characteristics that set him or her apart from other persons. These distinctive features are the most important part of the description of a person.

It is important that you be able to describe persons so completely and accurately that others will be able to readily recognize the individuals described. As in the case of observation, accurate description is facilitated by following a pattern, which normally proceeds from general characteristics to specific characteristics.

GENERAL CHARACTERISTICS.— The following commonly accepted and understood words, terms, and methods are recommended for use in describing general characteristics of a person:

- Sex.
- Race—Caucasian, Black, Native American, Hispanic, Mongolian, or Malayan.
- Height—exact or estimated. When the height is estimated that should be clearly indicated. A convenient method of estimating height involves simple comparison with your own height. For purposes of simplification, estimated height may be stated in 2-inch blocks, such as 5 feet 8 inches to 5 feet 10 inches, 5 feet 10 inches to 6 feet.
- Build (including posture).
- General—Large, average or small (slight).
- Specific—Obese (very stout), stout, stocky, medium, or slim (slender).
- Posture—Straight (erect), medium, or stooped.
- Females—In describing the build of a woman, bear in mind that, while the descriptive terms listed above are equally applicable and may be used there are basic differences in build and body proportions between the male and female figures. The female figure is normally smooth and rounded, while the male figure

tends to be angular with distinct muscular definition. An important part of the description of the build of a female is the appearance of the bust, which should be described as flat, medium, or heavy.

- Weight—exact or estimated. When the weight is estimated, that should be clearly indicated. As in estimating height, a convenient method for estimating weight is by comparison with your own weight. Estimates should be stated in 10-pound increments, such as 160 to 170 pounds, 170 to 180 pounds.

- Age—actual or estimated. When the age is estimated, that should be clearly indicated. For convenience, age may be estimated in multiples of 5 years. In describing a person's age, it may often be of particular importance to indicate not only the actual age but also the general age indicated by appearance.

- Complexion—pale, fair, dark, ruddy, sallow (sickly pale) or florid (flushed). Clear, pimpled, blotched, freckled, pockmarked, and so forth. In the case of a female, the description should include makeup habits such as none, light, heavy, or other applicable term or phrase. For persons of the Black race, complexion should be described as light brown, medium brown, dark or olive.

SPECIFIC CHARACTERISTICS.— In the interest of thoroughness and uniformity, you should pattern both your observation and your description of the specific characteristics of a person along systematic lines, normally beginning with the head and progressing downward.

The following words, terms, phrases, and methods are recommended for standard use in describing specific personal characteristics:

- Head—Size and shape—Large, medium, or small; long or short; broad or narrow; round, flat in back flat on top, egg-shaped, high in crown, bulging in back and so forth.
- Profile—Divide mentally into three parts or sections. Each third is then described in its relationship to the whole and in separate detail. Except in the case of peculiarities, the description of the profile is not normally as important for identification purposes as is the description of the frontal view of the face.
- Face—Round, square, oval, broad, or long (as seen from the front).
- Hair—Color as blond (light or dark), brown (light or dark), red (light or dark), auburn, black gray, streaked with gray, or white. In the case of bleached, tinted, or

dyed hair, both the artificial and the natural color should be indicated when possible. Density, as thick, medium, thin, or sparse; hairline, as low, medium, receding, receding over temples, and so forth. Baldness should be described as complete, whole top of head, occipital, frontal, receding, or the appropriate combination of types. Hair type, as straight, wavy, curly, or kinky; hair texture, as fine, medium, or coarse. Appearance, as neat, bushy, unkempt, oily, or dry; hairstyle, as long, medium, or short; parted on left, parted on right, parted in center, or not parted. Current descriptive terms of hairstyles which are readily and widely understood should be used as appropriate. Wigs, toupees, and hairpieces should be described carefully and in detail. The careful observer can often determine whether a person is wearing a toupee or other hairpiece from such indications as difference in hair texture, color, density, type, or appearance. Furthermore, the arrangement of false hair will often be too nearly perfect, and the edges of the hairpiece will often be evident upon close scrutiny.

- Forehead—High, medium, or low. Slope, as receding, medium, vertical, prominent, or bulging; width, as wide, medium, or narrow. Wrinkles or age lines, as none, light, deep, horizontal, curved (up or down), or vertical.

- Eyebrows—Color, including any difference from hair color. Slant from center (horizontal, slanted up, slanted down). Line, as straight or arched separated or connected; texture, as heavy, medium, or thin; hair, as short, medium, or long; plucked; penciled. In describing females, it is often important that both the natural and the artificial appearance and contour of the eyebrows be indicated.

- Eyes—Note color of eyes.

- Nose—Concave, straight, convex (hooked), reman, or aquiline. Nostrils should be indicated as medium, wide, or narrow; large or small; high or low; round, elongated, or flaring. Peculiarities, such as broken, twisted to right or left, turned up, pendulous, hairy, deep-pored, and so forth, should be carefully noted and reported.

- Mouth—Size (as viewed from front), small, medium or large. Expression, as stern, sad, (corners drooping), pleasant, or smiling. Peculiarities, such as prominent changes made when speaking or laughing, twitching, habitually open, and so forth, should be indicated.

- Lips—Thin, medium, or thick (as viewed from front); long, medium, or short (as viewed in profile).

Position, as normal, lower protruding, upper protruding, or both protruding. Color. Appearance, as smooth, chapped puffy, loose, compressed, tight (retracted over teeth), moist, dry, and so forth. Harelip and other peculiarities should be carefully noted. In the case of females, color, type, and extent of lipstick should be described. In this connection, be alert for the use of lipstick to alter or accent the natural appearance of the lips.

- Mustache and beard—Color, including any difference from hair color; style and configuration; and state of grooming (unshaven).

- Teeth—Color; receding, normal, or protruding; large, medium, or small; stained decayed, very white, broken, false, gold, flared, uneven, missing, or gaps between teeth.

- Chin—Normal, receding, or jutting (as viewed in profile); short, medium, or long (as viewed from the front); small, large, pointed, square, dimpled cleft, or double.

- Ears—Small, medium, or large. Shape, as oval, round, triangular, rectangular, or other appropriate term. Lobe, as descending, square, medium, or gulfed. Separation from the head should be described as close, normal, or protruding; and setting (based on a line extended horizontally back from the outside corner of the eye, which crosses the normally set ear at the upper third) should be indicated as low, normal, or high.

- Hearing aids—Hearing aids should be described in detail as to type (such as inside the ear, behind the ear, with cord, cordless), color, and ear in which worn.

- Cheeks—Full, bony, angular, fleshy, sunken, or flat. Cheekbones, as high (prominent), medium, or receding. In the case of women, makeup habits should be noted.

- Neck—Short or long; straight or curved; thin or thick. Adam's apple as large (prominent), medium, or small.

- Shoulders—Small, medium, or heavy; narrow, medium, or broad; square or round, level or one side lower. As seen in profile, straight, stooped, slumped, or humped.

- Arms—Long, medium, or short in comparison to rest of the body (average or medium arms terminate with the heel of the hand about halfway between the hips and the knee when the arms are hanging naturally). Muscles, as slight, medium, or heavy.

- **Hands**—Small, medium, or large in relation to the size of the individual. Peculiarities should be noted in detail.

- **Fingers**—Long, medium, or short; thin, medium, or thick (stubby). Deformities, such as missing fingers, disfigured nails, crooked fingers, and so forth, should be carefully indicated.

- **Trunk.**

- **Overall**—Long, medium, or short (in relation to rest of body).

- **Chest**—Deep, medium, or flat, as seen in profile; broad, medium, or narrow, as seen from the front.

- **Back**—Straight, curved, humped, bowed, and so forth, as viewed in profile; straight or curved, as viewed from the rear.

- **Waist**—Small, medium, or large.

- **Abdomen**—Flat, medium, or protruding.

- **Hips**—Broad, medium, or narrow, as seen from the front; small, medium, or large, as seen in profile. In this connection, keep in mind the basic differences between male and female figures, as discussed earlier in this section.

- **Legs**—Long, medium, or short in comparison to rest of the body (average or medium legs combined with the hips constitute about half the body length); straight, bowed (bandy), or knock-kneed; muscles as slight, medium, or heavy.

- **Feet**—Small, medium, or large in relation to body size. Deformities and peculiarities, such as pigeon-toed, flat-footed, clubfooted, should be carefully recorded.

- **Marks and scars**—Such identifying marks as birthmarks, moles, warts, tattoos, and scars should be clearly described as to size, color, location on the body, and shape.

- **Speech**—The tone and manner of a person's speech may often be very important aspects of the complete description. Habitual tone should be indicated as low, medium, or loud; soft or gruff; or by other descriptive qualities. The person's manner of speaking should be indicated as cultured, vulgar, clipped, fluent, broken English with accent (identified whenever possible), or non-English speaking (language specified when possible). Such peculiarities as stuttering, nasal twang, pronounced drawl, or a mute condition should be clearly indicated and explained.

- **Dress**—Since persons may change the clothing worn, its value for descriptive purposes is limited. Noticeable habits in manner of dress, such as neatness, carelessness, and preferences of style, should be indicated. Clothing worn by a person at the time of an offense or when last seen should be described in detail, such as military, civilian, mixed military and civilian, color(s), and condition (clean, soiled, torn, ragged, greasy, or bloodstained).

- **Personal appearance**—Neat or untidy; well-groomed or unkempt; refined or rough.

- **Mannerisms and habits**—Often the peculiar mannerisms or traits of a person will constitute the major or key parts of this description. You should be alert to record such characteristics as the following:

1. Feminine traits in men and masculine traits in women.

2. Peculiarities in walking, moving, or taking.

3. Outward emotional instability, nervousness, or indecision.

4. Type of companions preferred.

5. Subconscious mannerisms, such as scratching the nose, running the hand through the hair, pulling on an ear, hitching up the pants, jingling keys, or flipping coins.

6. Facial tics, muscular twitches, and excessive talking with the hands.

7. Kinds of recreation preferred or hobbies pursued.

8. Jewelry worn and types of jewelry preferred.

Objects

Objects described are generally limited to those located at the scene of an incident or crime, or other items identified by a witness or victim as pertinent. Due to the great variation in size, conformation, shape, and location of objects that may be described, it is not possible to prescribe a detailed pattern for their observation and description. However, as in the case of persons, the description of objects should begin with general characteristics and proceed to specific characteristics.

GENERAL CHARACTERISTICS.— The description of general characteristics should define clearly the general category of the particular object and preclude its being confused with objects of other or

similar category. The general characteristics should include those aspects of an object that are readily discernible, and may serve to effect quick and conclusive recognition.

SPECIFIC CHARACTERISTICS.— After describing the general or basic characteristics of an object and establishing its fundamental classification, proceed to describe systematically and in detail its specific characteristics. This part of the description will distinguish the particular object and set it off from all others similar in category. Therefore, it is essential to note and describe accurately all the details of the object of interest.

The pattern of this description will vary according to the type of object, but it should follow a general pattern, such as top to bottom, front to rear, or left to right. Such particulars as distinguishing marks, scratches, alterations, damaged parts, worn areas, signs of repair, faded paint, serial numbers, identifying markings, and missing parts should be indicated in detail.

Examples. The following are some typical descriptions that you may make, including specific characteristics of objects.

Typewriter. Brand name, nonportable, model 17, 11-inch carriage, light gray with ivory keys and black lettering, serial number J17-123456. Letter H key is bent and strikes below the line. Numeral 5 key is bent and sticks in the forward position; when stuck it must be returned manually to the rear position.

Man's suit. Brand name; dark blue; wool worsted; coat size 42 regular; half-lined with dark blue silk; coat lapels of wide width; single-breasted with three black buttons; four small black buttons on each sleeve; small tear in lining on right outside coat pocket; trousers size 33-inch waist, 34-inch length; unlined; not pleated; cuffs, 1 1/2 inches wide; and cleaner's mark JHO stamped in black on inside of the waistband.

Places

To present a concise and readily understandable word picture of the scene, place descriptions should contain all the elements and should proceed by the methods of observation previously discussed. To supplement word description, sketches and photographs should be made whenever appropriate. Some typical examples of place and scene descriptions follow.

Outdoor scene. The incident occurred on board the Naval Air Station, Pensacola, Florida, near the

intersection of Turner Street and Fisher Avenue. The exact location was the east sidewalk of Fisher Avenue, 10 feet due north of a fire hydrant located on the east side of Fisher Avenue approximately 20 feet north of the corner (curb) of Turner Street and Fisher Avenue.

Indoor Scene. The incident occurred in room 212 in building 624 on Fisher Avenue on board the Naval Air Station, Pensacola, Florida. Room 212 is located on the second floor of the building directly above the Fisher Street entrance. The room is reached using a stairway to the right of the Fisher Street entrance. The door to the room is wooden, with the room number printed on it in 2-inch block letters.

At the time of observation, and to the immediate right of the observer and the entrance door, were three rows of brown cardboard boxes stacked 6-feet high against the wall. Against the left wall and facing the center of the room was a standard size blackboard. In front of the blackboard was a 3-foot high podium with a wastebasket on the right side facing the center of the room.

In the wall facing the entrance door were two double-sash casement windows. The windows were furnished with ivory-colored venetian blinds closely drawn. Between the windows was a built-in three-shelf bookcase totally filled with books.

On the wall of the room to the left of the entrance door 3 feet from the window wall was a door, connecting with room 210, which was locked at the time of observation.

Between the two doors was a dark brown table with a wooden top approximately 2 feet by 2 feet in size. On the table were three plastic drinking cups, each partially full of a light-brown liquid, which appeared to be an intoxicant. In the center of the table was a 9-inch ashtray containing several extinguished brand-name cigarettes.

At a point 10 feet from the entrance door and 7 feet from the table near the left wall was an overturned wooden straight-back chair. The left rear leg of this chair was broken below the seat. The broken leg, which was still attached to the chair, was stained with a substance that appeared to be blood.

In the center of the room was a conference table, 10 feet long by 4 feet wide. There were four wooden straight-back chairs on the window wall side of the table and four chairs on the entrance door side of the table. In the center of the room on the ceiling directly above the table was a four-bulb fluorescent light fixture. The floor of the room was covered with light brown tile.

Events

Your description of an event should present as accurately as possible a reconstruction of the event as it actually happened.

The description must be as complete as time and circumstances make practicable and should always contain the essential facts of time, location, sequence of action, objects and persons involved and the immediate results of the occurrence.

In accomplishing a thorough and logical description of an event, consider all available information resulting from your own observations, statements made by witnesses and suspects, and the evaluation of physical investigative evidence obtained at the scene. Whenever appropriate, the description is supplemented by sketches and photographs.

OBSERVATION, DESCRIPTION, AND IDENTIFICATION BY WITNESSES

Observations, descriptions, and identifications made by witnesses or victims of incidents and offenses constitute a major source of extremely useful information. It is essential that a high level of skill be acquired in obtaining information from such persons, in accurately evaluating this information in the light of all related data, and in using the evaluated information in conducting subsequent investigative activities.

Observation

Although, as the investigator, you cannot control either the fact or the technique of observation by other persons, you may, through skillful and patient questioning, often aid a witness in recalling details of persons, objects, places, and events observed. Since the witness may not be trained or experienced in observing methodically or in a set pattern, it may be possible for you to develop a reasonably clear word picture of what the witness observed by encouraging the use of a pattern of recall.

When encouraged to recall in a methodical fashion, a witness may often realize that he or she actually saw much more than was consciously recorded at the time of observation.

Before you can perfect your techniques of obtaining and developing the description of observations made by other persons, you must acquire an awareness of, and be able to make appropriate allowance for, the many factors that may tend to influence an individual's

perception, interpretation, and retention of details observed. Such factors may be external or human.

External influences include the following:

1. Location of witness at time of observation. It is unlikely that two or more persons will have witnessed an incident from exactly the same location. Differences in location may often account for differences in observation.

For example, a person who witnessed an event from a great distance may be able to give a good overall description of what took place but be unable to expound on details of the persons or objects involved. On the other hand, a person who witnessed the same event at very close range may be able to describe in detail the persons, objects, and component actions involved but be unsure as to the overall picture of what took place. Similarly, the height of an observer above or below the subject of observation influences the observer's interpretation.

2. Weather and light conditions. The effects of weather and light variations upon observations of individuals are fairly self-evident. You should not, however, fail to make proper allowance for them.

3. Absence or presence of distracting events or circumstances. Unrelated but concurrent events may greatly influence a witness' observation of events important in a particular incident. Thus, an exciting play on a football field may cause a spectator to fail to observe closely or accurately what the person sitting in the next seat is doing.

4. Lapse of time since the observation was made. The passage of time between observation and recall can greatly influence an individual's description of what was witnessed. The imaginative person may often tend to fill in through conjecture the gaps about an incident, particularly if it is subsequently learned that the incident is important in an investigation. On the other hand, many persons will tend to forget or confuse details of an incident with the passage of time.

It is extremely important that witnesses and victims be interviewed as soon as possible after they made their observation and before they had time to adjust their observations, consciously or unconsciously, to fit the pattern of other information they may have seen or heard.

Human factors. An individual's perception is largely determined and influenced by a number of individual differences in past experiences, physiological and psychological influences, and

training. Within the framework of these differences, an individual evaluates and interprets stimuli received by the senses. You should recognize the implication of individual differences and be able to evaluate their effects upon the observations of a witness or victim.

Experiences. A person's evaluation and interpretation of what that person observes tend to be predetermined by past experience of similar or related occurrences. The size of an object is, for instance, compared with the size of another object with which the individual is familiar. Familiar sounds, odors, tastes, and comparable perceptions will usually be properly interpreted by an observer, while incoming stimuli with which there are not past comparable perceptions will often be misinterpreted in terms of familiar things. Similarly, inaccurate interpretation of past experiences may have formed a pattern that will influence the individual's subsequent interpretation of similar observations.

In general, as the investigator, you should bear the following in mind:

1. Young persons have limited past experiences on which to base interpretations. Yet, depending upon their individual interests, they may be entirely capable of quite accurate observations. For example, many American males can quickly recognize and identify the make and model of an automobile but would not be likely to perceive details of the driver, license number, or make and condition of the tires.

2. Normally, the mature person has had a variety of experiences upon which to base interpretations. That person's experience, however, is limited to normal occurrences in his or her area of residence and employment. Thus, a lifelong resident of a metropolitan area might be entirely incapable of accurately describing a farm scene. A native of a tropical island could hardly be expected to describe in minute detail a high-speed motor vehicle accident.

3. In the case of elderly persons, physiological influences may often preclude proper application of patterned interpretation as molded by experience, or experiences may be so varied and interrelated as to result in confused interpretation. For example, an aged person may not be able to recall details of what was observed, or may tend to supply incorrect details from some similar but unrelated past experience.

4. Specialists in particular fields of endeavor normally develop very acute perception within their respective fields but are especially unobservant in other fields.

For example, an artist will normally be acutely aware and take specific note of color, form, and proportion but may fail to discern or properly interpret sounds or odors.

Similarly, a motor vehicle mechanic will usually be quick to observe the sound of a motor or other indications of the state of repair of an automobile but may be inexact in describing the appearance and actions of the driver.

Physiological influences. Defects, both permanent and temporary, in the physical condition of an individual may greatly affect the ability to observe accurately and to interpret his or her observations properly. Such factors as age, disease, injury, underdevelopment, and undernourishment must be considered whenever appropriate. Pain, hunger, fatigue, and unnatural positions of the body may cause a witness to inaccurately interpret observations that he or she would normally place into proper mental perspective.

The following general factors should be considered:

1. A person who is unusually short or tall may misinterpret the size of another person. For example, a person 6-feet tall may appear very tall to an observer who is only 4 feet 10 inches tall, while the same 6-footer would likely appear to be of normal height to an observer who is 5 feet 10 inches tall.

2. The senses of hearing and touch of a blind person are usually developed far beyond those of a person with normal vision. Thus, a blind person may frequently perceive sounds or note details of objects touched which the normal person may fail to observe.

3. The senses of taste and smell are subject to frequent distortion by physical disorders and by external stimuli. The presence of a strong taste or odor may completely conceal the presence of other tastes or odors. Consequently, these two are usually considered the least reliable of the senses as a basis for interpretation.

For example, the presence of strong cooking odors in a room may result in an individual's failing to note the presence of a more subtle odor of importance in a particular case.

Psychological influences. Temporary or permanent emotional disturbances, such as fear, anger, worry, prejudice, or mental instability, may impair the functioning of a person's senses and result in inaccurate observation. You must acquire the ability to recognize these influences and make proper allowances for them. For example:

The victim of a robbery may be in such fear of a weapon used by the perpetrator that the victim's recollection of the incident will be only that of the size of the bore of the weapon, and will not be able to accurately describe the perpetrator. Furthermore, such an individual might be expected to exaggerate the size of the bore.

A witness of an incident may so dislike a particular person involved as to see only the actions of that person to the exclusion of the actions of other persons involved.

Occasionally, a witness may be so prejudiced against a class or race of persons that his or her interpretation will be inaccurate even though the witness' senses recorded a true report of what occurred. For example, an individual who has formed a dislike for police and similar officials may unwittingly permit this prejudice to affect the interpretation of observation of the actions of a night watchman or a security guard.

Training. Specialized training may intensify an individual's power of observation. However, such training may tend to focus the observer's attention onto particular characteristics to the detriment or exclusion of other details.

Description

Some witnesses may be able to give concise and factual accounts of their observations without aid from you. However, in almost every case it will be necessary for you to ask questions to develop details considered unimportant by the witness, to assist the witness in evaluating and interpreting observations, or to reconcile discrepancies in the statements of different witnesses.

While little can be done to influence or mold the observations of witnesses, you can greatly enhance and facilitate the witness' investigative activities through the employment of skillful techniques of questioning witnesses and thereby obtaining from them descriptions of that which they observed.

Some of the factors that affect the accuracy of a description by a witness, and for which you should learn to make proper allowances are as follows:

1. Lapse of time between observation and rendering of the description.
2. Witness may tend to relate only those details deemed to be important.
3. Language inadequacies or lack of expressive ability may preclude a witness' giving an accurate description.

4. Fear of police or police methods might cause a witness to be incapable of coherently describing what was observed.

5. Witnesses may intentionally withhold information so as not to become involved or to avoid personal inconvenience.

When obtaining a description from a witness, you should learn as much about the witness as is possible within the limitations of time and urgency. You should consider individual differences that may affect the witness' interpretation of what was observed. You should determine those influences that might tend to cause the witness to withhold or intentionally distort certain details.

Without extensive background investigation, which the urgency of most cases will usually preclude, it may be difficult to determine applicable individual differences and influences. However, certain techniques may be used by you to help determine the extent of these influences. Three of these techniques are:

1. Talking briefly with the witness prior to questioning may tend to alleviate apprehensions regarding police and police methods, self-involvement, and inconvenience. During such preliminary talk, you may discover numerous individual traits that may tend to influence the witness' interpretation of what was observed.
2. Having the witness repeat a description may reveal discrepancies made either inadvertently or intentionally. Pointing out and discussing such discrepancies may lead to a better description by the witness or an admission of intentional distortion.
3. Weighing the description made by a witness in the light of all available information in the particular case will help you to evaluate the witness' credibility. A witness suspected of concealing information or of intentionally lying will usually make unconscious slips, which the trained investigator will note. However, you should bear in mind that there are many factors, such as self-interest, love, loyalty, desire to appear important or intelligent, desire for conformity or to be different, or reward, which may cause an individual to unintentionally err in his or her interpretation of observations.

Identification

It is imperative that you conduct identification activities in such a manner as to preclude possible error or injustice.

Before an identification is undertaken, you should make sure that the witness has made as complete and as detailed a description of his or her observations as possible.

To avoid false identifications and ensure maximum elimination of possibility for error, the witness should be given the opportunity to make comparisons of similar persons, objects, places, and events. For example, showing a witness a single weapon or confronting the witness with one person for identification purposes may confuse the witness, and lead him or her to make a false identification simply because the weapon or person has been shown by you. Instead the witness should be asked to identify a person or object from among a group of similar persons or objects.

A witness attempting to identify a place should be asked to describe it in detail after having described its general location in relation to known landmarks. Then the witness should be asked to lead you to the scene.

Certain specific techniques may prove useful in identification procedures. These include the following:

- **Composite photographs and sketches.** In the identification of persons, a technique using composite photographs or sketches may often be valuable. This technique involves showing the witness a number of photographs or sketches of facial features, such as foreheads, eyes, noses, mouths, chins, and so forth, and asking him or her to select in each instance the one that most nearly resembles that particular facial feature of the person to be identified.

- **Use of an artist.** The services of an artist may be used to provide a likeness of persons or objects. From the description given by a witness, or from a composite of the descriptions given by several witnesses, a skillful artist can often prepare a sketch or portrait that will be of value in locating the subject of interest.

This technique may also be advantageously combined with the use of composite photographs or sketches. Or, if these are not available, the witness may be shown numerous photographs of different persons or objects and requested to indicate to the artist or to you those features that most closely resemble those of the person or object to be drawn.

In the case of an object, the witness may be able to accurately describe an item of well-known appearance or one from his or her own property without the aid of photographs of similar objects. The ultimate goal is production of a drawing or portrait that will be useful in furthering the investigation.

The Lineup

An additional technique of identification is the lineup. It is used to minimize error and eliminate false identification of persons or objects. The lineup offers the advantage of a confrontation without leading or misleading the witness or victim. In setting up a lineup, certain legal requirements should be met for the validity and acceptability of the lineup.

Location for a lineup may be almost any area available to you. It should be held in an area that is screened from public view, to avoid attracting unwanted attention or disturbance. When the lineup involves people, it should be in a room or space large enough for at least six people to stand side by side. A lineup involving objects should be held in a place that is logical to the item being identified, such as a car in a parking lot with other cars, or a coat in a closet with other coats.

Lighting should be of sufficient intensity to enable viewing of the lineup. When people are involved in a lineup, lighting should be planned to prevent the persons in the lineup from clearly seeing the person making the identification.

Preparing and Directing the Lineup

There are certain procedures that must be followed in conducting a lineup to ensure its proper operation. These include selection of lineup personnel, their preparation and directions, and control of the witness/victim.

Personnel selection should be such that the people in the lineup are of the same general physical description; that they have the same distinctive features (such as glasses, beard, and so forth), and that they are presented wearing the same general type of clothing. (As a rule, law enforcement personnel should not be included in the lineup.)

In setting up the lineup, each person should be provided with a numbered card. A record is then made by name and number of each position in the lineup. The lineup should be photographed to help verify that it is conducted correctly and to verify the location of people in the lineup. If the people are in uniform, insignia, accoutrements, and name tags should be removed or covered. The people should be in clothing that is the same as may have been described earlier by the witness. That is, if the suspect was wearing a hat, all people in the lineup should be wearing hats. It is permissible for movement directions to be given to the lineup personnel if necessary, such as facing the lineup left or right.

There are certain procedures for which the witness or victim should be instructed or prepared. Witnesses should not be allowed to see a suspect before the actual lineup. They should be told how the lineup will be conducted before it begins. They should NOT be told that a suspect is actually in the lineup. They should not be pressured to make a statement. All conversations of the witnesses should be recorded during the lineup. There should be a standard series of questions prepared before convening the lineup if the witness is to be questioned. If more than one witness is to view a lineup, each should do so separately. Witnesses should not be allowed to communicate with each other during a lineup, as one may adversely influence the other.

Lineup of objects for identification may be of considerable importance to an investigation. When this technique is used, a group of six or more objects similar to and including the object that needs to be identified. Ample time should be given to the witness to view the group of objects in an attempt to identify the object.

The *Navy Law Enforcement Manual*, OPNAVINST 5580.1, contains further details on lineups.

SURVEILLANCE OPERATIONS

LEARNING OBJECTIVES: Explain surveillance operations and describe the terms used. Describe the planning, preparation, and personal qualifications for surveillance operations. List some of the precautions to be observed in surveillance, and identify the types and methods of surveillance.

Surveillance operations are excellent methods for acquiring police information. However, they require sound techniques and the use of experienced, trained investigators. They are closely related because, in each instance, the investigator relegates official standing to an obscure identity to accomplish the mission.

Because of the total involvement and, in some cases, danger to the investigator, surveillance operations are used only when necessary as the best way or, as in many instances, the only way of achieving the desired results.

Surveillance operations are used in many ways and require special skills and qualifications. One of the most important required skills is adeptness in police observation and description. This section depicts investigator requirements and the “how” and “why” of surveillance operations. Police surveillance is the systematic observation of persons, places, or things to

obtain information. Normally, a surveillance is covert and concerned primarily with persons; places and things are observed incidental to, or as they relate to, certain people.

Surveillance Terms:

Subject—the person, place, or thing under observation.

Surveillant—a person engaged in observing a subject.

Contact—any person the subject meets with or with whom the subject confers.

Convoy—a person used by a subject to detect a surveillance—usually done by following the subject.

Decoy—a person who attempts to divert the surveillant’s attention from the subject.

“Made,” “burned,” or “blown”—terms used to relate that the surveillance or the identity of a surveillant has been discovered by the subject.

Surveillance may be used to identify locations frequented by persons of interest to the investigation and places where criminal activity is conducted. It is used to obtain information on the scope and nature of a person’s activities. One important use of surveillance is to verify the reliability of informers.

Although this section addresses covert surveillance almost exclusively, overt surveillances are used on occasion. An overt surveillance is used when it is to the surveillant’s advantage to let the subject know he or she is being observed.

For example, a nervous subject maybe purposefully made aware that he or she is being followed and made to feel that an arrest is imminent. This could cause the subject to falter in his or her actions and expose others involved to the investigator.

PLANNING FACTORS, PREPARATION, AND PERSONAL QUALIFICATIONS

When a surveillance is necessary, all available information on the subject should be compiled for the surveillant.

Before the surveillance of a place, a reconnaissance should be conducted to determine entrances and exits, vantage points, and the character of the area. Such information will help determine how many surveillants are necessary; if the surveillant will observe from a vantage point, the street, or a combination of the two;

and how the surveillant should dress to blend in with the environment.

If the subject is a person unknown to the surveillant, the best method of identification is to have the subject pointed out to allow the surveillant to make a personal observation. The surveillant should also be briefed on any of the subject's known habits, contacts, or habitats, and be provided with a photograph and a detailed and accurate description of the subject. A photograph and detailed description of the subject's automobile should also be obtained.

The surveillant is selected for his or her skill, experience, and resourcefulness. Normally, the surveillant should be of average size and should not have any unusual physical characteristics. In addition, the type of surveillance and the area in which it is conducted are key factors in determining who can best accomplish a surveillance operation. Also, the surveillant must have a lot of patience so as not to seem apprehensive or become discouraged.

The surveillant's attire should be in harmony with the area in which the surveillance is to be conducted. Clothing (civilian or uniform) must blend with the environment so that if the subject sees the surveillant one or more times, it will not make a lasting impression or arouse suspicion.

Appearance should not stop at just the manner of dress. Rings or other jewelry indicating professional status or societies may have to be removed. Moreover, the surveillant must not reflect by appearance or habits that he or she is a law enforcement officer.

The surveillant should have as much knowledge of the investigation as possible to accurately interpret the actions of the subject. The surveillant should also know the elements of proof of various crimes to be able to know when the subject has gone far enough to warrant apprehension.

The suspect must be kept under observation until the offense is thoroughly completed except in those offenses which if completed would result in bodily harm to victims.

Continued surveillances, even after all the elements of a crime have been completed can be rewarding. The surveillant should not be too anxious to make an apprehension. Wait and observe.

Notes should be prepared by all parties to the surveillance of all actions they witness the subject(s) perform.

A surveillance plan is necessary to ensure that all contingencies that can be anticipated before a surveillance action are considered and resolved. It is necessary to coordinate the actions of two or more surveillants.

It is unnecessary for a surveillance plan to follow a formal outline, or to even be written. However, some plan should be formulated and each surveillant should become thoroughly knowledgeable in every aspect of the operation through presurveillance meetings or briefings.

The plan should specify the general concepts of operations and duties, cover stories for each surveillant, alternate courses of action and communications, and equipment to be used.

The surveillant may be required to use a cover story if confronted by the subject. The cover story should be substantiated by dress, speech, mannerisms, and logic. Individual surveillant resourcefulness is irreplaceable in a situation where the cover story has to be related. The surveillant should not offer any information to the subject since, in many instances, the information can be checked by the subject.

Planned, alternate courses of action allow the surveillant to react smoothly to contingencies, anticipated previously, as they occur, such as moving from a foot- to a vehicle-surveillance, or reacting to a convoy.

Communications enable a coordinated effort and, as in any other operation, can influence the success or failure of the mission. Radio contact is imperative in a vehicle surveillance and is used extensively in other surveillance methods. Prearranged signals, especially in a foot surveillance, are often the only means surveillants have of relaying messages. Telephone contact may also be used when appropriate, especially when its use harmonizes with techniques that mask the surveillant's actions.

There are no standard equipment requirements for a surveillance.

SURVEILLANT PRECAUTIONS

The surveillant is faced with two possibilities that could destroy weeks or months of preparation and work—that of being discovered and of losing the subject at a critical time. Even the most experienced investigator can be "burned" or "shaken." However, adequate planning and the use of trained personnel can assure continuity in surveillance of the subject.

The surveillant should avoid direct eye contact with the subject, preventing the subject from recalling the surveillant's face should eye-to-eye contact be required later. If obviously looking away from the subject would arouse suspicion, the surveillant should focus on a point beyond the subject, giving the impression of eye contact without actually establishing it.

Abrupt or unnatural movements can call attention to a surveillant. Many times a subject will test to see if he or she is being observed by rapidly changing course or by other means. The surveillant must react quickly but naturally to these movements by the subject. In some cases, it may be better to lose sight of the subject momentarily than to arouse suspicion.

The surveillant carries a sufficient amount of roomy, including change, to cover such contingencies as meals and telephone calls.

Barracks, theaters, dining facilities, and base transportation pose special problems to the surveillant. Generally, it is necessary to move closer to the subject when entering barracks and theaters to preclude the subject's leaving through one of the various exits. In dining facilities, the surveillant should enter the facility behind the subject and take a position to ensure constant observation of the subject.

The surveillant selects a meal that is quickly prepared. Should the subject depart before the surveillant is served, the surveillant should leave.

Inexperienced surveillant must overcome a tendency to believe that they have been discovered simply because the subject glances their way several times. Normally, when the subject knows he or she is being observed, it will become obvious. The subject will take actions to harass or lose the surveillant.

TYPES OF SURVEILLANCE

There are two general types of surveillance—mobile and fixed. A *mobile surveillance* is commonly known as tailing or shadowing. A *fixed surveillance* is often called a stakeout. A mobile surveillance can be conducted by foot, vehicle, or a combination of the two, depending on the subject's movement. A fixed surveillance is used when the subject is stationary or when all the essential information can be gathered in a single location. Even in a fixed surveillance, the surveillant may remain mobile, moving from one vantage point to another.

METHODS OF SURVEILLANCE

The MA or command investigator will rarely be required to perform a complex surveillance operation, and most of the time will be limited to a fixed surveillance. Therefore, only basic surveillance methods will be discussed.

Three basic methods are used in surveillances: loose, close, and a combination of the two.

Loose surveillance. During a loose surveillance, the subject is not kept under constant observation. This method is used when the information sought can be obtained from a particular facet of the subject's activities, to spot check a subject, or as a long-term method of compiling information on a subject. A loose surveillance should be broken if the suspect indicates in any way that he or she suspects a surveillance is being conducted.

Close surveillance. The subject is maintained under constant observation in a close surveillance. Even in a situation where the surveillant loses the subject, a close surveillance should continue through an alternate plan.

Combination of loose and close surveillance methods. A situation may exist where an illicit activity will be under a close surveillance. As a result, a loose surveillance may be initiated at the same time against certain persons who frequent the activity. Surveillants may also find cause in some instances to move from a loose to a close surveillance as a result of an act or a contact by the subject. Prior planning provides for the best techniques to be used for such possibilities.

FOOT SURVEILLANCE

Even though a one-person surveillance technique may be called for by the nature of the investigation or the actions of the subject, a one-person surveillance should never be used. This is because of the inherent danger of the subject, a convoy, decoy, or criminal associates attempting to physically eliminate or neutralize the one-person surveillant. A second surveillant should be used with a primary mission to protect or provide assistance, as required, to the main surveillant.

If a one-person foot surveillance is required, the surveillant should use extreme caution when operating on the same side of the street as the subject. The surveillant should stay to the rear of the subject with varying proximity maintained with respect to his or her position and the position of the subject. This is determined by physical conditions, such as the problems

created by crowds and the number of exits. If the subject turns a corner, the surveillant should cross the intersecting street, keeping the subject in view. The surveillant can then operate across the street from the subject and fall in behind the subject again as the situation permits.

When the surveillant is operating across the street from the subject, circumstances dictate whether to operate to the front, abreast, or behind the subject. The key to deciding on any positional vantage is observation—from what position observation is best. Normally, when the subject turns a corner in this situation, it is best to be abreast of him or her so that any contacts or entries into a building can be observed.

If the subject enters a telephone booth, the surveillant should enter an adjacent one to overhear any conversation, if possible. The subject maybe simulating making a telephone call to see if he or she is being followed.

When it is necessary for you to go into an adjacent telephone booth in an effort to overhear the subject's conversation, do not simulate making a call. Deposit the required coins, dial, and then simulate a conversation.

An effort should be made to recover items discarded by the subject or to recover second sheets from pads that the subject has used. However, the surveillant should avoid picking up an item discarded by the subject when this might lead to recognition of the surveillant.

VEHICLE SURVEILLANCE

The same basic principles apply to foot surveillance and vehicle surveillance. However, techniques in the basic principles of vehicular surveillances are more difficult, because of the complications created by traffic congestion, restrictions imposed by traffic laws, and the greater possibility of the surveillant being discovered. As in the case of close foot surveillances where two or more surveillant are more effective, two or more vehicles enhance the prospects for success in a vehicle surveillance.

Whenever possible, each vehicle should be occupied by two surveillant. Pairing the surveillant in vehicles permits greater alertness, provides mutual coverage, and allows the flexibility necessary to react to the numerous contingencies that may arise.

For example, if the subject stops and parks a car rapidly, one surveillant can follow the subject on foot while the other looks for a parking place from which

observation of the subject's vehicle may be made inconspicuously. In such a situation, one surveillant in a vehicle would in all probability lose sight of the subject.

Preparation of Surveillant Vehicle

A vehicle selected for surveillance duty must be mechanically sound and suitable for the area in which the surveillance is to take place. The vehicle should be equipped with a radio, especially if two or more surveillant vehicles are involved. This provides for coordination between surveillant teams and for obtaining assistance if required.

Surveillance vehicles should be devoid of all official markings and bear the license plate of the county or state in which the surveillance takes place. If possible, vehicles are changed periodically in a surveillance of long duration.

Other Techniques

There are techniques to minimize the risk of detection, such as disconnecting the dome light of the car so light will not show when a door is opened. Operating the microphone of the radio should be done inconspicuously. One of the headlights and the license plate light can be wired to permit them to be turned on or off independently. That permits a change in the traffic pattern as seen by the subject. If traffic conditions are heavy, the headlights should not be tampered with.

Violations of traffic laws should be cleared with the security department and their advice considered. The advice of the legal officer should also be sought in these situations.

It is much more difficult at night for surveillant to be sure they are following the right vehicle. The subject's car can be better kept in sight if the car is distinctive. If the opportunity presents itself, a piece of reflectorized tape may be attached to the rear of the car.

When one vehicle is used for surveillance, it should remain close enough behind the subject to permit the surveillant to observe all actions, but far enough behind to escape detection.

When the surveillant vehicle is parked, one surveillant should be out of the car for better observation. The surveillant remaining in the car should sit on the passenger side and appear to be waiting for the driver, thus lessening the chances of attracting the subject's attention. The surveillant may even change to

the back seat or move the car to a different parking place periodically.

When the subject turns a corner, the surveillant have two possible moves. They may continue in the original direction, or cross the intersecting street, to make a U-turn (see figure 15-2). The subject will take little interest in a car from behind turning into the street from a direction that is opposite that to which he was traveling before turning the corner.

In all vehicle surveillances, the surveillant should become familiar with the area of operation by a map study and an on-the-ground reconnaissance. If time does not permit the reconnaissance, maps should be carried in the vehicle. If necessary, the surveillant in the passenger seat can navigate for the driver.

FIXED SURVEILLANCE

In a fixed surveillance, or stakeout, it is the subject who remains stationary. The surveillant may move around for closer observation of the area or subject. When one surveillant is detailed to watch a place with more than one exit, the surveillant may have to move about considerably to maintain proper surveillance.

When you are preparing for a stakeout, the base of operations should be well-planned. It maybe an office, apartment, house, automobile, or truck. A thorough, but cautious, reconnaissance should be conducted of the area or building from which the surveillance is to be made. Necessary equipment, such as binoculars, cameras, and sound recording devices, should be provided.

Specific arrangements should be made to provide relief for the surveillant and for communications contact with headquarters. In situations where the surveillant cannot observe from a fixed base, it may be necessary to assume a role that will not attract undue

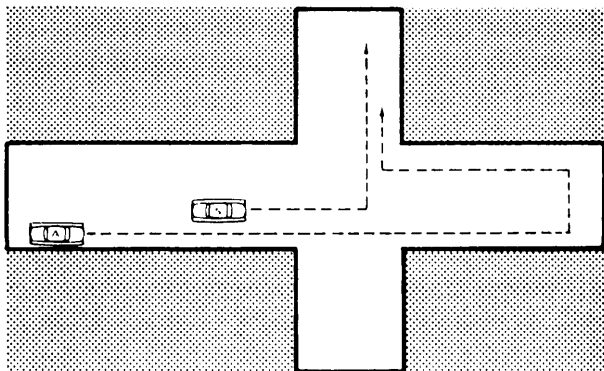

Figure 15-2.-One-vehicle surveillance.

attention. The use of disguised vans and trucks as observation posts in fixed surveillances should be considered.

OTHER TECHNIQUES

Obviously, all surveillance techniques have not been covered in this chapter. There are numerous adaptations and combinations of the basic techniques discussed. You will develop these and apply them as you gain experience.

The surveillant or surveillance team should be prepared to switch from foot surveillance to vehicle surveillance, and vice versa. No one walks everywhere, nor rides to every destination. It is also likely that two types of surveillance will be combined.

A technique of loose surveillance that has proved extremely useful when time permits and the subject follows an established routine is progressive surveillance. In this technique, the subject is observed during a particular phase of daily routine, or for a specific period of time on one day, and the cutoff point recorded. The next day, the surveillance is picked up at the previous day's cutoff. This process is repeated until the subject's activity has been thoroughly covered.

INTERVIEWS AND INTERROGATIONS

LEARNING OBJECTIVES: List the reasons for conducting an interview or interrogation. Explain the difference between an interview and an interrogation. Describe the legal considerations and human factors involved in interviews and interrogations. Identify the need for witnesses, methods used with the opposite sex, and the types of persons who may be questioned. List and explain the elements involved in conducting interviews and the elements involved in interrogating suspects.

During the course of any investigation, often the most valuable sources of information are the people involved. The investigator interviews or interrogates them for a variety of reasons, some of the more common being the following:

- To gain information to establish the facts of the crime, including determination of whether or not a crime actually occurred

- To verify or tie-in prior information received from other persons involved in the investigation or from physical evidence left at the scene
- To identify any additional witnesses
- To identify perpetrator(s) and accomplice(s)
- To secure additional evidence
- To develop background information on the specific crime/offense
- To eliminate suspects
- To discover details of other offenses

DEFINITIONS

Interview. An *interview* is the questioning of a person who has or is believed to have information of official interest to the investigator. In an interview, the person questioned usually gives in his or her own manner and words a personal account of an incident under investigation or offers information concerning a person being investigated. After the person gives the account of an incident, the investigator should review it with that person and amplify certain points and clearly explain matters not previously mentioned, depending on the elements of the offense under investigation.

Interrogation. An *interrogation* is the questioning of a person suspected of having committed an offense or of a person who is reluctant to make a full disclosure of information pertinent to an investigation.

LEGAL CONSIDERATIONS

In addition to the legal considerations discussed in chapters 2, 3, and 4, you, the investigator, should become thoroughly familiar with the laws applying to the specific offense under investigation before you conduct an interview or interrogation. A knowledge of these laws will assist you in evaluating the relevancy of information received and assist you in the detection of incriminating points in statements.

You should avoid any oversight or mistake that would impair the value of the results of an investigation to the person or agency using the results in a legal action.

Often, through questioning a suspect for one offense, investigative leads or admission of guilt related to other offenses may be developed. This additional information may be of value to you or other law enforcement agencies.

HUMAN FACTORS

Human factors affect your success in stimulating an interviewee to talk, and influence the accuracy or truthfulness of the information you secure from the interviewee. You should evaluate each interviewee and the information furnished, attempting to understand the interviewee's motivations, fears, and mental makeup. You should use your understanding of the interviewee to gain useful information.

In selecting a technique of interview or interrogation, you should consider perception or memory, prejudice, reluctance to talk, and personality conflicts.

Perception and Memory

The validity of the information divulged during an interview or an interrogation is influenced by the interviewee's ability to perceive correctly what happened in his or her presence, to recollect that information, and to transmit it correctly to the investigator. A mistake made in recalling a particular incident is often due to one or more of the following:

- Weakness in the interviewee's ability to see, hear, smell, taste, or touch.
- Location of the interviewee in relation to the incident at the time it occurred. Rarely do two people give the same account of an incident witnessed by them.
- Lapse of time since the incident occurred or the interviewee's having had no reason for attaching much importance to the incident when it occurred. The account given of an incident at a later time is often colored, consciously or unconsciously, by what the interviewee has heard or seen regarding the incident since it occurred. Furthermore, an interviewee may fill in the gaps of a particular incident by rationalizing what was actually seen or heard and may repeat the entire mixture of fabrication and fact to the investigator as the truth.

Therefore, an individual should be interviewed or interrogated as soon as possible after the occurrence of an incident. Even then, all your skill is required to discover what the interviewee actually observed and can recall accurately. Additionally, a suspect who is interviewed as soon as possible has less time to formulate alibis with potential conspirators or to establish an otherwise viable sequence of events.

Prejudice

When answering questions, most interviewees are often influenced by one type of prejudice or another. Information obtained in a detailed manner will often preclude the misleading information that prejudiced persons will furnish if allowed to talk in generalities.

You may also be influenced by prejudice. To guard against this, you must train yourself to stick to the facts.

Reluctance to Talk

You may encounter a person who is reluctant to divulge information. You must legally overcome this reluctance to secure the information you need. The most common reasons for reluctance to talk are the following:

Fear of self-involvement. Many persons are not familiar with police methods and are afraid to aid the police. They may have committed a minor offense they believe will be brought to light upon the least involvement with the police. They may think the incidents that occurred are not their business, or that guilt lies jointly on the victims and the accused. They may fear publicity that may be given to persons involved in any way with criminal cases. They also fear reprisal against them.

Inconvenience. Many persons disclaim knowledge of incidents because they do not wish to be inconvenienced by being subjected to questioning or by being required to appear in courts.

Resentment toward police and police methods. This resentment may be present particularly among persons who do not have a positive loyalty to the organized community. Sometimes the resentment manifests itself as sympathy for an accused person, regarded as the underdog pitted against the impersonal, organized forces of society represented by the police.

Investigator-interviewee personality conflicts. The lack of success in an interview or interrogation may be due to a personality conflict between the investigator and the interviewee. When that is the case, the investigator should recognize this factor and, before all chances of success are lost, should voluntarily withdraw in favor of another investigator. The interviewee may feel a compulsion to talk to the new investigator after an experience with the investigator who, for one reason or another, was found objectionable.

WITNESSES TO INTERVIEWS AND INTERROGATIONS

There is usually no requirement to have a witness to a nonsuspect interview or interrogation. With suspects, however, someone should be present to witness the advisement of rights and the oath-taking and signing of any written statements obtained from the suspect.

There is nothing that prohibits an interrogator from excusing the witness to the interrogation, after a waiver of rights is obtained if the interrogator prefers certain psychological advantages that come from a "person-to-person" relationship with the suspect. You can call the witness back before the suspect swears to the truthfulness of the statement and signs it.

There normally should not be more than two interrogators present in the interrogation room, since interrogating a suspect in the presence of many law enforcement personnel has been held by the courts to be suggestive of duress. It is also recommended that the witness to the completion of the Rights Warning and Waiver Certificate and the witness to the statements of a suspect be the same person. This has the practical aspect of requiring only two investigators to appear in court rather than three.

INTERVIEWS/INTERROGATIONS OF MEMBERS OF THE OPPOSITE SEX

An investigator should never jeopardize an interview or interrogation by ignoring the fact that a victim, witness, or even a suspect may be reluctant to talk to a member of the opposite sex about intimate subjects. In some cases, however, the opposite may be true. The investigator should be sensitive to this and plan the session accordingly. Additionally, when interviewing or interrogating a member of the opposite sex, a second investigator or command representative should be present to avoid false claims of investigator misconduct.

TYPES OF PERSONS INTERVIEWED AND INTERROGATED

During criminal investigations, you may have occasion to question many types of persons, including victims, witnesses, informers, complainants, and accusers.

Victims

A victim normally is interviewed to develop the facts of an incident. This interview may take place in a hospital, at the victim's dwelling, or at another location not of the investigator's choosing.

A victim is not always a reliable or cooperative witness. Unreliability and uncooperativeness are sometimes caused by fear of some form of retaliation, a state of mental or physical shock, poor memory, possible involvement of relatives or friends, or fear of publicity.

Also, a victim may be too eager to please and attempt to cooperate by exaggerating and distorting facts. It may be necessary to interview a victim several times before all facts are correctly disclosed.

Occasionally, it is necessary to interrogate a victim. Victims commonly inflate values of property to obtain a larger claim. Also, victims may attempt to hide their involvement in an offense. This is common in rape and homosexual investigations, and in drug-related offenses.

Witnesses

A witness is a person—other than a suspect—who has information concerning an incident. A witness may also be the victim, complainant, or accuser who first notified the authorities of the incident.

The witness must be sought by the investigator when he or she does not voluntarily come forward to present his or her knowledge of the incident. A witness may be a person who saw the crime committed; a person who can testify as to the actions and whereabouts of the accused at the time the crime was committed; a person who knows facts or heard the accused say certain things that would tend to establish a motive for the commission of the crime; a scientific specialist who examined the physical evidence and can give impartial testimony in court concerning such evidence; or a person who by personal knowledge of certain facts or occurrences can contribute to the overall knowledge of the case.

A witness is usually interviewed, but may be interrogated when suspected of lying or withholding pertinent information.

It is not necessary to warn a witness of his or her rights unless he or she has uttered statements that lead you to believe the status of the witness has changed to that of a suspect. If this occurs, all questioning must cease and the suspect must be informed of his or her legal rights.

Informers

The success and efficiency of investigations often depend to some extent on persons who furnish information about criminals and their activities. This source of information is protected by the investigator, who often interviews the informer under conditions of the informer's choosing.

Complainants and Accusers

During an investigation, a person may report on or accuse another person. The complainant or accuser is usually interviewed. In some cases, however, it may be desirable to interrogate an accuser or complainant who is suspected of lying, of distortion, of concealing the fact that he or she provoked the accused, or of attempting to divert suspicion from himself or herself. Providing a false official statement is a crime in itself. (See UCMJ, Art. 107; 18 U.S.C. 1001 (1976).) Therefore, a rights warning and waiver may be required.

Others

Information is often needed that will give a clearer understanding of the motives and actions of persons involved in an incident. In acquiring such information, the investigator interviews persons acquainted with the victim, suspect, witness, or informer. These interviews are normally conducted in the office, home, or place of business of such a person. Rarely do these interviews result in an interrogation.

Distracting Persons

You may encounter persons who have no real connection with a crime or possess no knowledge of it, but who nevertheless present information to you. They may claim to be witnesses or victims, or even perpetrators. Despite the lack of any real basis for their statements, these persons should not be dismissed lightly. You should listen to their stories, evaluate what they say in relation to the known facts, and take the necessary action.

Sensation or publicity seekers. Persons in this class are not often encountered during investigations. Some emotionally disturbed persons, however, may present themselves as witnesses, as additional victims of known suspects, or as accomplices of suspects who have received considerable publicity. You should make every effort to handle publicity seekers in such a manner that will not harm the investigation. You should be aware of attention-seeking behavior.

Grudge-bearing and lying witnesses. Because of previous difficulties with an accused or suspected individual, or to settle an old score, a person with no real knowledge of an incident may volunteer information about, or profess to be a witness to, an incident. A thorough familiarity with the known facts and details of the incident will often enable the investigator to detect inconsistencies in the story of such a person.

The testimony of the grudge-bearing or lying witness may closely parallel the accounts of the incident released to the press or allowed to circulate through other channels. Where the real motives of such a witness are obscure to the investigator, all possible background information should be developed to disclose the untruths and the motivation for the witness' statements.

False accusers. A false accuser may make a charge that later investigation will disclose to be groundless. Sometimes, such a charge will persist until a trial is conducted. A false charge is, at times, an exaggerated version of an actual crime of a lesser nature, but it is sometimes made when no offense has been committed. False charges are particularly prevalent in sex cases, and are not uncommon in other crimes.

A false charge may represent the sincere, though erroneous, thinking of the victim, or may rest on the victim's reaction to previous ill-will, suspicion, or jealousy.

All of your skill is required in the initial interview with an accuser to separate truthful from unfounded accusations. It should be remembered, however, that this should be done in a diplomatic manner. Anything you do to slight a person who volunteers such information or to make him or her feel that the reporting of the matter was foolish or undesired may close off a future source of reliable information.

CONDUCTING INTERVIEWS

You should prepare yourself adequately to conduct an interview. This preparation is sometimes hasty, consisting of no more than a mental review of your knowledge of the case or of a quick briefing by the Master-at-Arms or security patrolman who arrived first at the crime scene. When time permits, a more formal preparation is made. Preparation, whenever possible, includes the following three elements:

1. Familiarity with the case. You should fix in your mind all that is currently known of the who, what, when, where, how, and why of the crime. You should

pay particular attention to the specific details, especially those that have not become public knowledge.

2. Familiarity with the background of the interviewee. You should acquire some background knowledge of the interviewee before attempting an interview. If this is not possible, you should attempt to obtain the background information from the interviewee during the initial portion of the interview. This knowledge will enable you to adopt a correct questioning technique and to extract maximum valuable information. This knowledge will also enable you to test the interviewee's truthfulness and to impress him or her with the thoroughness of the investigation.

Background facts of particular value include:

- Age, place of birth, nationality, and race.
- Present or former rank (for civilians-status in business or in the community).
- Educational level, present duty, and former occupations.
- Habits and associates—how and where leisure time is spent.
- Information in records of courts-martial or civilian court convictions, information in detention records, and information regarding the nature and seriousness of offenses committed.
- Information in records in the local security office.

3. Estimate of information sought. When possible, you should determine in advance the information to be sought in the interview. In complex cases, you can prepare a set of questions that you can consult unobtrusively during the interview. The questions are designed to induce the interviewee to tell his or her story rather than to elicit "yes" or "no" answers.

You should take care neither to overestimate nor to underestimate the interviewee as a source of information. Plan a systematic questioning session. Detailed information, needed by you for a variety of reasons, is not often provided by interviewees unless they are questioned carefully and systematically.

Carefully planned questioning stimulates recall and enables interviewees to provide the best possible descriptions of persons, places, things, and events.

Planning the Interview

A person involved in an investigation should be interviewed as soon as possible since, at best, memory is short and as time passes is often affected by outside influences. It must be kept in mind, however, that there are times when interviews or interrogations are best postponed until they can be conducted in a logical and chronological sequence. Generally, cooperative witnesses are interviewed at their earliest convenience when you have time to conduct a thorough, unrushed interview.

At times, as in the case of responding to the scene of a crime or accident, preliminary questioning is accomplished at the scene and followed up with a more detailed interview as soon as possible.

Generally, willing witnesses, excluding those who are interviewed at the scene, are interviewed where they feel psychologically comfortable such as in their homes or offices. If, however, individual witnesses would feel uneasy in a police environment, and it would not cause undue hardship for them to be interviewed at your office, there is no objection to doing so.

With suspects and hostile witnesses, again referring to those who are not questioned at the scene, it is best to conduct the questioning in a proper interrogation room as described later in this chapter or in any other available location where the investigator enjoys the psychological advantage.

Introduction and Identification

You should introduce yourself courteously and make certain that the interviewee is aware of your correct identity. You should show your credentials if any doubt appears as to your authority in the investigation. When interviewing women in their homes, the male investigator should stand several steps from the door until the interviewee is convinced of his identity and has invited him into the residence.

You should also make certain of the identity of the interviewee. Before questioning any interviewee suspected of an illegal offense, the interviewee must receive an appropriate warning. The warning should be presented prior to obtaining all the administrative data needed for the investigation.

A hasty introduction or the appearance of haste at the beginning of the interview may make the interviewee feel unimportant and that the information he or she is in a position to give is of little value. A few minutes spent in a proper introduction are not wasted.

The introduction gives you time to evaluate the interviewee and the approach you have selected. The interviewee, then, is given an opportunity to overcome any nervousness and is usually in a better frame of mind to answer questions.

Opening Statement

When the introduction is completed you should make a general statement about the case without disclosing any of the specific facts that have been developed. When talking to civilians, avoid the use of military terms and abbreviations.

If appropriate, warn the interviewee of his or her rights. The warning is required only when there is reason to believe the interviewee is involved in the offense in question, or may be involved in another offense—the investigation or prosecution of which may be jeopardized if the warning is not given.

The Interview

Your attitude and actions usually determine the success or failure of the interview. You should be friendly and businesslike, endeavor to get the interviewee into a talkative mood, and guide the conversation toward the interviewee's knowledge of the case. The interviewee should be permitted to tell his or her complete story without unnecessary interruptions. As stated earlier, the questions should be phrased so as to maintain a free flow of talk rather than brief "yes" or "no" answers. Discrepancies and inconsistencies should be noted and resolved. Specific approaches are:

1. The indirect approach is generally used with ready, willing, and able interviewees. They are simply asked to tell their stories in their own way. You are mainly a "listener," asking questions only when needed to clarify information furnished. Leading questions which suggest an expected answer are avoided.

2. The direct approach, where specific, direct questions are asked and you become a "questioner," is used when the interviewee is not ready, willing, or able to provide the information desired for one reason or another. Leading questions are sometimes necessary, but should be avoided especially with an unstable person.

Here are some special considerations:

When interviewing a victim of a crime, particularly a crime of violence, or an otherwise emotional witness, you must keep in mind the emotional state can result in an exaggerated account of the incident. A follow-up

interview, when the emotional interviewee has calmed down, is recommended.

With any interviewee who is a victim, always begin the interview by displaying concern and consideration for the victim's injuries or losses and give assurances that you will do your utmost in behalf of the victim.

Two good reasons for doing that areas follows:

1. The truthful victim will feel he or she has come to the right place and will try to recall details that will be helpful to you.

2. The lying victim will be placed off-guard and will be more likely to mention discrepancies in the story that you will be able to detect.

Photographs and sketches are often useful during interviews. When shown to interviewees, they orient interviewees and investigators, ensure mutual understanding, and help assure complete coverage of the matter being discussed.

Sketches are particularly valuable during questioning of large numbers of individuals who were present when multiple offenses were committed. The individuals questioned can locate their own positions on outline sketches and relate their observations to known time and distance factors. Care should be taken to mark for identification and preserve such photographs and sketches for possible use as exhibits in court.

You should attempt to record interviews for future reference. Any interview can be recorded as a statement by the interviewee, on an electronic recording device (with the permission of the interviewee), or in the form of notes taken. The last method is the most commonly used.

When taking notes, keep in mind that many persons become disturbed when they realize that what they are saying is being recorded. Therefore, notes should not generally be taken until after the interviewee has told the story at least once and you have clarified and summed up what has been told.

Exceptions occur when it is necessary to jot down certain information such as addresses, telephone numbers, and detailed descriptions of persons or stolen items. Should the interviewee display annoyance toward note-taking, delay note-taking until immediately after the interview.

A consensual electronic recording provides a convenient means of preserving the content of an interview. The recording should be carefully kept in its entirety, together with any stenographic transcripts

made. A complete chain of custody should be maintained for all such items, as they may later prove valuable in legal proceedings if they can be duly identified and authenticated.

When using electronic recording devices to record interviews or interrogations, the consent of the witness or suspect must be obtained preferably in writing. Should you encounter an individual who refuses to grant permission do not use an electronic recording device. If you have questions regarding the use of electronic recording devices, consult the NCIS.

Upon termination of the interview, display your appreciation for the cooperation of the interviewee. This applies not only to interviewees who have been completely cooperative from the very beginning of the interview but also to those who initially had to be encouraged and motivated to finish the information sought. No promises or hints of confidentiality should be given.

The time required in bringing the interview to a close may be used successfully to secure valuable additional information. Reluctant suspects or witnesses may tend to drop their guard after the questioning has ceased and you have put your notebook away. The interviewee who has successfully suppressed pertinent facts during the interview may mention such facts immediately following the interview. By carefully handling the witness or suspect, you may secure the facts that eluded you during the interview.

Evaluating Information Received

After obtaining information from any interviewee, you should evaluate the information obtained by comparing it with information received from other interviewees, with observations at the scene of the crime or incident, with physical evidence in the case, and with any other information you may have received.

During the interview, the mannerisms and emotional state of the interviewee may be helpful in evaluating the reliability of the information. Personalities of individuals, however, differ to such an extent that it is better to evaluate the information as stated above. Some interviewees, for example, can lie without displaying any nervousness or outward signs of lying. Others, even though they are being truthful, display nervousness whenever they talk to anyone in authority or become involved in any way with law enforcement personnel.

In your evaluation, you should strive to obtain a clearer picture of the entire case as it has progressed to this point. If any discrepancies exist among information obtained from different sources, they should be resolved through reinterviews or any other means possible.

Quality Control

Supervisors of investigators should check on the quality of performance of their investigators as often as their manpower resources allow.

Supervisors can best evaluate the effectiveness of investigators during the interview by reviewing results to assure that investigators are not consistently obtaining negative results, and by periodically, as situations allow, witnessing interviews conducted by investigators. However, supervisors must use discretion when deciding to witness an interview and should not do so if the investigator, who is more knowledgeable of the case, feels the supervisor's presence would jeopardize interview results.

Additionally, supervisors can talk with interviewees shortly after interviews have been conducted to determine their attitudes following the interview.

INTERROGATING SUSPECTS

To some degree, the general rules that apply in interviewing nonsuspects also apply in interviewing suspects. Special considerations must be given, however, in certain areas. If a suspect is ready, willing, and able to tell the truth, the suspect should be allowed to do it in his or her own way, after appropriate advisement of rights.

Preparation for an interrogation should be as thorough as time permits. It should be similar to the preparation for an interview.

Planning the Interrogation

You should base your plan for interrogation on the facts of the case and the background information developed on the subject. Statements of witnesses, in addition to information derived from physical evidence of the case, enable you to reconstruct the crime mentally and to anticipate some of the facts or fiction that you may obtain from the subject during the interrogation. Then decide on your initial techniques and alternates should the initial techniques prove unsuccessful.

When suspects are apprehended at the scene of the crime, it is sometimes advisable, after a Rights warning

is given and oral waiver obtained to interrogate them on the spot. Whether this would be psychologically advantageous will depend on the individual suspect and your appraisal of the suspect.

It should be noted that the longer the delay between apprehension of the suspect and the time of interrogation, the better the opportunity for the suspect to gain composure, fabricate alibis and, in some cases, communicate with accomplices. In any event, do not attempt to advise a suspect of his or her rights during apprehension until after the suspect has been searched for weapons.

Even in cases where offenders are apprehended immediately after the crime, interrogations should be delayed until the suspect is brought to the investigator's office. Here, in a proper interrogation room, the suspect should be advised of his or her rights; and if the rights are waived, a signed waiver should be obtained and witnessed by you and one other person.

If, at the time of apprehension, you plan to delay questioning of the suspect, a full Rights warning should be given immediately. Also, you should tell the suspect that you do not intend to conduct an interview until later.

NOTE

There is no reason to warn the suspect immediately after apprehension unless you plan to ask questions/interrogate. However, the suspect should be warned if you plan to interrogate him or her immediately. The suspect should also be warned if there is undue delay between apprehension and formal interrogation time frames.

When a suspect is not apprehended at the crime scene but is later identified through investigation, the best time to schedule the interrogation is not necessarily as soon as possible.

In some cases, it may be better not to let the suspect know you have identified him or her and to delay the interrogation until all other investigative leads are completed, including determining the complete background of the suspect. This allows you the greatest possible psychological advantage in the interrogation.

The interrogation should be scheduled so that no other activities interrupt it or cut it short. Because the interrogation is normally time-consuming and never hurried, no time limit is placed on it. The interrogation,

however, is not continued for a length of time that would be suggestive of duress.

It is difficult to state in advance how long is too long. A rule of thumb is for you to be able to show the court that you were considerate of the suspect's needs for food, water, personal hygiene, and rest.

As was previously stated, a criminal, surprised and apprehended in the act of committing a crime, is not usually interrogated on the spot. Such questioning is normally of little value to establish the involvement of the criminal in the offense the subject was caught committing, since that is well established by being caught in the act. Properly handled, however, this interrogation may produce a confession that will clear up other like crimes—such as a series of burglaries. Also, such interrogation may help to identify accomplices.

Ideally, the interrogation should be conducted at an interrogation room where facilities are available for recording the interrogation; where secretarial assistance is available; and where witnesses are available to guard against possible charges of abuse, duress, or coercion, and to observe the manner in which statements, admissions, and confessions are obtained. At a regular interrogation room, you can arrange for privacy during the interrogation, control the physical environment, and make reasonably certain that the interrogation will not be interrupted.

The interrogation room should be plainly but comfortably furnished without pictures or similar items that could distract the attention of the subject. The surroundings should not remind the subject that he or she is in police custody or jail.

Two-way mirrors and similar equipment should be installed so they appear as normal furnishings insofar as possible. Acoustic tile may be used to soundproof the room. When possible, the room must also have temperature control, including air-conditioning, to preclude later defense counsel claims that a confession was “sweated” or “frozen” out of the accused. The furniture should consist of a small, narrow table to write on, but which gives the suspect nothing to “hide” behind and three comfortable chairs.

Anything that might be needed such as paper, statement forms, the *MCM*, an ashtray, and so forth, should be in place before beginning the interview or interrogation. No telephone should be in the room, as its ringing might distract the suspect at the wrong psychological moment in the interrogation.

Weapons or articles that might serve as weapons are not left in any interrogation room. The door should have a “Do Not Disturb” sign.

If an interrogation room is not available to you (as it will not be aboard ship) you should try to furnish your office or a space to be used as an interrogation room to conform with the guidelines previously discussed for an interrogation room.

Classifying Suspects

Suspects are classified as follows:

1. Known offenders whose guilt is reasonably certain because of evidence available. These offenders may be more readily influenced by sympathy or understanding, or by logic.
2. Suspects whose guilt is doubtful or uncertain because of lack of essential facts or because of weaknesses in the available evidence.

Some suspects cannot be placed precisely in either of these two categories. The accuracy of your efforts to classify a suspect depends upon your ability and experience and upon the availability and accuracy of information developed about the suspect or the case. An incorrect classification may lead to an unsuccessful interrogation if the questioning technique based on the original classification is not skillfully modified or changed during the interview.

The Interrogation

As in beginning a witness interview, you should introduce yourself and make sure the suspect is aware of your identity as a law enforcement officer. Before you ask any incriminating questions, tell the suspect what offense he or she is suspected of and advise the suspect of his or her rights.

Although there are as many techniques as an investigator's imagination will allow, there are only two approaches: indirect and direct.

Indirect approach. The indirect approach is exploratory in nature. It is usually used when interrogating a suspect whose guilt is uncertain or doubtful. In the indirect approach, the questioning is designed to develop a detailed account of the suspect's activities before, during, and after the time the offense was committed. Alibis offered by the suspect should be checked to determine their truthfulness. Facts that are definitely known to you and that suggest the suspect's guilt should be used in formulating questions to test

reactions and to determine whether the suspect is inclined to lie.

When evidence is lacking or is weak, you must proceed cautiously to place the suspect in a position where he or she will be forced to distort or alter facts that are definitely known to you. The suspect should then be requested to explain satisfactorily any discrepancy or distortion of factual information. You may, at times, imply that much more is actually known by making statements or by asking questions that lead the suspect to believe that the answers are already known.

When, due to statements made by the suspect, you become more certain of the suspect's guilt, you may wish to switch to a direct approach.

Direct approach. The direct approach is normally used to interrogate a suspect whose guilt is reasonably certain. In using this approach, you should assume an air of confidence with regard to, and stress the evidence or testimony indicative of the guilt of the suspect. In the direct approach, behave in an accusatory manner displaying complete belief in the suspect's guilt and strive to learn WHY the suspect committed an offense rather than IF the suspect committed the offense.

Suspect Interrogation Techniques

The techniques or the number of possible techniques used during an interrogation are limited only by your imagination and modified by limitations placed upon you by the laws and courts. Two of the most commonly used techniques are the psychological, and the logic and reasoning techniques.

Psychological approach. This approach is designed to focus the thoughts and emotions of the suspect on the moral aspects of the crime and thus bring about a realization that a wrong has been committed. Great care should be taken in using this approach to make sure that the suspect does not become so emotional as to render any statement made inadmissible.

You may begin this type of interrogation by discussing the moral seriousness of the offense; by appealing to the suspect's civic-mindedness or to responsibilities of citizenship; or by emphasizing the effects of his or her acts on the suspect's family or close relatives. From this beginning, proceed to such matters as the sorrows and suffering of the victim and the victim's relatives and friends.

The suspect may tend to become emotional when discussing a mother or father; a childhood and

childhood associations; early moral and religious training; and persons held in very high esteem, such as school teachers, religious instructors, athletic coaches, neighbors, or friends. This tendency is particularly true when a suspect is guilty of a crime that he or she feels violates the moral values that are associated with these people. Often, the emotional appeal of some person or personal relationship increases in intensity with the passage of time and with the distance separating the suspect from a former environment. By emphasizing the contrast between a present and a former way of life, you may intensify the suspect's emotional response, especially when he or she has deserted a family, has become orphaned or otherwise separated from a family, or when the way of life prescribed in early moral and religious training has been forsaken.

The psychological approach is often successful with a young person and with a first offender who has not had time to become a hardened criminal or to develop a thinking pattern typical of a hardened criminal.

You must realize that skill is required in using this approach. The basic emotions and motivations most commonly associated with criminal acts are hate, fear, love, and desire for gain. By careful inquiry into the suspect's thinking, feeling, and experience, you are likely to touch upon some basic weakness and thereby induce in the suspect a genuine desire to talk. Attempt to think along the same lines as the suspect, and to make every effort to establish a common ground of understanding. Assist the suspect to construct a "face saving" rationalization of the motives for committing the criminal act, and thereby make talking about the crime easier.

Logic and reasoning. The habitual criminal who feels no sense of wrongdoing in having committed a crime must normally be convinced by you that guilt can be easily established or is already established by testimony or available evidence. You should point out to the suspect the futility of denying guilt. The suspect should be confronted at every turn with testimony and evidence to refute alibis, that his or her guilt is definitely a matter against which no lies will defend.

Other techniques. Should psychological, and logic and reasoning techniques appear inappropriate, or fail to produce an admission or confession, techniques of a more subtle nature may be used.

You should plan the use of your technique carefully, so you will not be obvious to the suspect. Furthermore, you should be careful not to jeopardize the success of further interrogative effort by disclosing to the suspect

just how much or how little information has been obtained.

The serious student of interrogative techniques can find a variety of them discussed in several technical books written on the subject. You must, however, be alert to detect, among the various authors, techniques that differ in name only. You must also select only those that fit your own personality.

Some of these techniques follow:

THE HYPOTHETICAL STORY. Relate a story of a fictitious crime that varies only in minute details from the offense that the suspect is believed to have committed. After a lapse of time, request that the suspect write the details of the crime that have been related. If guilty, the suspect may include details that are identical with the actual offense and that were not mentioned in the fictitious crime. When confronted with this fact, the suspect may be influenced to make an admission or confession or may be forced to lie some more to extricate himself from a difficult position.

THE "COLD SHOULDER". Invite the suspect to your office. If the suspect accepts the invitation, he or she is taken to the crime scene. The investigators accompanying the suspect say nothing to the suspect or to each other; they simply await a reaction. This technique permits the suspect, if guilty, to surmise that you may have adequate evidence to prove guilt, and may induce him or her to make an admission or confession. If witnesses whose identities are known to the suspect are available, they may be requested to walk past the crime scene without saying or doing anything to indicate to the suspect that they are aware of his or her presence. This procedure serves to intensify the suggestion that the facts of guilt are already established.

PLAYING ONE SUSPECT AGAINST ANOTHER. This technique may be used if more than one person is suspected of having been involved in the commission of a crime. There are many variations of this method. In all variations, one suspect is played against another by purposely encouraging the belief of one suspect that a companion in the crime is cooperating or has talked about the crime and has laid the blame on the suspect you are interrogating.

The suspects normally are separated and are not allowed to communicate with each other. Periodically, they may be allowed to glimpse or to observe each other from a distance, preferably when one is doing something that the other may construe as cooperation and as prejudicial to the observer's interests. You may sometimes confront the stronger suspect with known

facts that have been allegedly furnished by the weaker suspect. Known details of the crime maybe mentioned in the presence of the stronger suspect under conditions that compromise the weaker suspect. One suspect may be cordially treated, or even released while the other may be given the cold shoulder.

This method is most successful when you infer rather than assert that the suspect has confessed.

Another technique is to play down the offense. An example of this would be in larcenies of large dollar items. Many times, if you show more interest in the recovery of the property rather than the actual role played by the suspect, results are better.

Recording and Evaluating Interrogations

Interrogations can be recorded by the same methods used for interviews. Under normal circumstances, do not take notes during the interrogation. The interrogation requires such a degree of concentration that the diversion of note-taking would almost certainly disrupt your "rhythm" in questioning or your train of thought. Notes are generally taken after the suspect has made a statement and are often, in fact, a rough draft of a written statement the suspect has agreed to furnish.

The results of an interrogation of a suspect are evaluated in the same manner as those from nonsuspects.

Confessions

When obtaining a confession from a suspect, the investigator makes sure that all elements of proof for the particular crime have been covered. The *MCM* should be reviewed whenever doubt exists. During the taking of a written statement, the elements of proof should also be covered to enable the reader to have a clear understanding of the crime.

Number of Investigators

During the interrogation, you may find you are unable to obtain factual information or a confession after having used several techniques and are becoming fatigued. That may cause the suspect to persist in lying or denials. You may lose control of the interrogation. A second investigator can continue the interrogation and use techniques not previously used by you.

You should clearly advise the second investigator, in the presence of the suspect, that the suspect has been advised of all legal rights. The second investigator

should ascertain from the suspect that he or she clearly understands and desires to continue. During the interrogation by either investigator, patience and perseverance are the key elements.

WRITTEN STATEMENTS

Written statements are permanent records of the pretrial testimony of accused persons, suspects, victims, complainants, and witnesses. They may be used in court as evidence attesting to what was told to investigators, to refresh the memory of makers of the statements, or the memory of the Master-at-Arms, security patrolman, or investigators.

Statement and Rights Waiver Forms

Whenever possible, interviews with pertinent witnesses, victims, or complainants should be recorded on a Department of the Navy Voluntary Statement (OPNAV 5527/2).

The Department of the Navy Suspects Acknowledgement and Waiver of Rights form (Military, OPNAV 5527/3 and Civilian, OPNAV 5527/4) should be used to record suspect statements.

The requisite format for completing a Voluntary Statement and Acknowledgement and Waiver of Rights forms can be found in the *Navy Law Enforcement Manual* (OPNAVINST 5580.1) and the *Report and Forms Preparation Guide for the Navy Security Force*.

PREPARATION.— The statement or body of the statement is generally recorded using one of three accepted methods: narrative, question-and-answer, or a combination of narrative and question-and-answer.

The *narrative method* allows the interviewee/person executing the statement to record the information in his or her own words as desired. That is ideal if the person is articulate and does not compile a mass of irrelevant information. The narrative is used more often with a complainant or witness than with a victim or suspect.

In the *question-and-answer method*, the investigator/interrogator can limit the information presented to that which is pertinent. Two disadvantages of using this method are (1) it is time-consuming for the investigator/interrogator and, (2) it may suppress some valuable information that might have been volunteered had the narrative method been used.

A combination of the above two methods normally produces the best results. The person being questioned

is first allowed to tell his or her story and then the investigator/interrogator elicits specific information previously omitted. This method or the question-and-answer method is most often used when taking a statement from an accused or a suspect.

The last section of the Suspect's form is known as the affidavit. It acknowledges that the statement was given voluntarily, that mistakes have been corrected and that the number of pages contained in the statement have been verified. The investigator then administers an oath to the interviewee by stating, "Do you swear or affirm that the information given by you in this statement is true and correct to the best of your knowledge, so help you God?" If the interviewee objects of the use of "God," that word maybe deleted from the oath

After the interviewee has answered in the affirmative, the statement is signed by the interviewee, the interviewer, and a witness.

The statement is written in the first person. In addition to signing the statement, the maker initials the bottom of each page and all corrections. The last sentence of each statement will be "End of Statement."

If a mistake is made and noticed before another word is typed the word should have marks over each letter and a space thereafter for the interviewee's initials. The wrong word then, cannot be seen and will cause no doubt when and if the statement is introduced into court. If noticed after completion of the statement, the word is lined out, written properly above the mistake, and then initialed by the interviewee.

The Suspect's Acknowledgment and Waiver of Rights form should be filled out each time an accused or suspected person is questioned and when a witness becomes suspect. Initiation of this form begins when the interviewer/interrogator states his or her official position, the nature of the offense being investigated, and that the person being interviewed is now suspect or accused of a particular offense.

This information can be stated in the investigator's own words as long as the accused or suspected person understands. However, the rest of the Rights warning must be read word for word from the certificate form. By reading the form word for word, uniformity and completeness in the reading of the rights are ensured in each instance, leaving little doubt as to the voluntariness of any statements subsequently made by suspects.

This form can be carried by the investigator or agent to have the Waiver and Rights readily available for field use.

If a person does not wish to be questioned and/or wants lawyer counsel before questioning, make an appropriate entry on the form, indicating that the person either desires a lawyer or declines to be questioned or say anything.

If the person orally waives his or her rights but refuses to sign the waiver certificate, you may proceed with the questioning. Make notations on the waiver certificate to the effect that the person has stated that he or she understands his or her rights, does not want a lawyer, wants to discuss the offense(s) under investigation, and refuses to sign the waiver certificate.

In all cases, the waiver certificate must be completed as soon as possible. Every effort should be made to complete the waiver certificate before any questioning begins. If the waiver certificate cannot be completed at once, as in the case of street interrogation, completion may be temporarily postponed. Notes should be kept on the circumstances.

The most important thing to remember is to record all information and circumstances relevant to the reading of the rights and the responses of the accused or suspect.

INTERPRETERS

When in an overseas area you may have to question a person with whom you cannot converse directly because of language differences. This may also occur on rare occasions while working in CONUS. This problem should be solved through the use of an interpreter.

The interpreter should be a member of the Armed Forces or a U.S. citizen, but if it is impossible to obtain such a person, a qualified local inhabitant can be employed.

Knowledge of the foreign language is the best solution to your problem and the best means of checking the accuracy, loyalty, and obedience of your interpreter. You, however, should not attempt an interrogation alone unless you are fluent in the foreign language and certain of your ability to phrase and understand intelligent questions and to clearly understand answers given by the subject. Whenever you have any doubt as to your ability, you should use a qualified interpreter.

Choosing an Interpreter

An interpreter should possess the following qualifications:

- Be intelligent and capable of learning rapidly the habits, methods, and procedures of different investigators.
- Be educated in both the foreign language and English. Must be able to communicate clearly and intelligibly to all persons you are likely to question.
- Be honest and free from criminal tendencies. If a native of the area, he or she should be free from unfavorable notoriety among the local inhabitants.
- His or her reputation or standing in the community prohibits intimidation by persons of higher rank and standing. A person's social and educational level is often discernible from speech habits or peculiarities.
- Be willing to accept a subordinate role in the actual questioning of persons; that is, the interpreter must permit you to ask the questions and to receive and evaluate the answers.

Controlling the Interpreter

You must make certain the interpreter performs assigned duties correctly and does not take over the questioning. You are responsible for the investigation and for any interview or interrogation. Therefore, you must remain in complete control.

You ask the questions, receive the answers, and evaluate the information and each person who gives information. You should use the interpreter as a means of overcoming the language barrier.

Specific things to be avoided include the following:

- The interpreter must never ask questions other than those originated by you or paraphrase your questions or the subject's answers.
- The interpreter should never intimidate or berate the subject or engage in any behavior that will lower your prestige or adversely affect the investigation.
- The interpreter should never hold back information given by the subject because it may adversely affect the interpreter.
- You, in turn, should never bully, criticize or admonish the interpreter in the presence of the subject. Criticism is made in private to avoid lowering the

prestige of the interpreters, thereby impairing his or her effectiveness.

Questioning Procedure

The normal procedure for questioning through the interpreter includes the following:

- You should, insofar as possible, prepare in advance and in writing the questions you intend to ask. The questions should be clear, brief, and of the type that will elicit brief, factual answers.

- Questions should be provided to the interpreter in advance so that any special vocabulary research required may be accomplished before the interview.

- The interpreter should stand or sit to the side and slightly forward of you so he or she can converse with the subject, and you, by merely a turn of the head. Do not permit the interpreter to move about or to do anything that will distract the subject's attention from you.

- You should address the subject directly, developing good eye contact to hold his or her attention. Ask the questions slowly and clearly in concise and unambiguous English. Slang or other obvious expressions peculiar to a region or district, which may confuse the interpreter, should be avoided. If the subject and interpreter begin an extensive conversation or argument, you must put an immediate stop to it.

- The interpreter should translate your questions into the language of the subject. The interpretation should be done promptly in a clear, well-modulated voice, reproducing the tone and emphasis used by you.

- The subject should answer the questions in his or her native language.

- The interpreter should repeat the subject's answer in English, in as literal a translation as possible, without use of such expressions as, "He says" or "I believe he is lying." If you desire an explanation of an answer that concerns the use of or meaning of a word, request it from the interpreter at a later time. If you need clarification of a fact from the subject, secure it by asking the subject appropriate additional questions.

- You should never instruct the interpreter to ask the subject a question. By the same token, insist that the interpreter translate the subject's answer directly and literally. In other words, never turn to the interpreter and say, "Ask him if he knows John Doe." nor do you permit the interpreter to reply, "He says he does." Instead, the

question should be put directly to the subject in English, "Do you know John Doe?" and you should receive the answer through the interpreter as though it were answered in English by the subject, "Yes, I know him."

- You may find it desirable and necessary to make verbatim notes of the answers as they are given by the subject. In these instances, the interpreter must speak slowly and distinctly.

- In some cases, you may use a stenographer or a recording device. If the stenographer speaks both languages, record all the statements made in both languages. An electronic recording device could be used wherever possible in subject interviews and as required in other instances if the interviewee consents to its use. Such a device affords a permanent record of the questioning in both languages and is a means of cross-checking the accuracy and fidelity of the translation.

- The interpreter should be instructed to make a translation of long statements at regular and convenient pauses during the subject's utterances. The interruptions must come at the end of complete thoughts. This procedure may be difficult if the subject is allowed to give extensive narrative versions of the information. Therefore, questions that require extensive explanations and may cause the subject to stray should be avoided.

INVESTIGATION OF JUVENILE OFFENDERS

LEARNING OBJECTIVES: Define the terms used in the investigation of juveniles, and explain *jurisdiction of juveniles* both at home and overseas. Describe the authority of law enforcement personnel, and identify the public law concerning youthful offenders. Explain the responsibility of the military sponsor as parent, and list the types of juvenile offenses that most often occur on naval bases. Describe the investigative procedures and techniques used for juvenile offenders.

This section provides broad guidelines relative to the investigation of various offenses committed on military reservations by juveniles not subject to the UCMJ. Discussion is specifically limited to problems encountered in investigating the delinquent acts of juveniles, but the basic information relative to criminal investigation of crimes and other offenses outlined in this chapter and previous chapters is applicable, since a

considerable percentage of all types of crime is committed by youthful offenders.

The community activities and facilities found on most military reservations are there to provide military personnel with the surroundings essential for morale, family development, and leisure activities.

The disturbing effect of juvenile delinquency is not restricted to the civilian community. Dependent minors of military personnel are as likely to commit delinquent acts as any other youths. Moreover, such acts may discredit the military and endanger good relations with the surrounding civilian community, as well as cause personal harm and property damage. It is important, therefore, that the Master-at-Arms understand the nature of the problem created by the youthful offender, and some of the more obvious causes of juvenile delinquency.

DEFINITIONS

Juvenile. The age limits for classifying persons as juveniles vary according to the law of the particular state involved. Title 18, U.S. Code, Section 5031 defines *juvenile* as “a person who has not attained his or her 18th birthday.”

Juvenile delinquent. A youth under the age of 18 who commits an act that would be a crime if it were committed by an adult.

Juvenile dependents. The dependent children of any military sponsor.

Civilian juveniles. Children of nonmilitary persons who reside on, or who enter the military reservation, thereby coming under some control of the installation commanding officer.

Sponsor. The in-service parent of a juvenile.

JURISDICTION

Police authority exercised on a military reservation may be military, Federal, state, or local, or a combination of these. The jurisdiction of the agency exercising police authority will depend on (1) the type of offense committed, and (2) the authority of the state or Federal Government to legislate for the installation. The issue of jurisdiction is important, as it will determine which police agency will handle cases involving juvenile offenders. In areas of concurrent jurisdiction, the issue of which agency will become involved in a particular case is more often a matter of policy than of law. Thus, close liaison must be

established between the security officer, judge advocate, and civil authorities.

Military Jurisdiction

The UCMJ does not apply to either dependent or nondependent juveniles. It does, however, apply to members of the military under 18 years of age. Base commanding officers are delegated responsibility for all aspects of base activities and have been given the authority to take necessary actions to ensure the protection of public and private property, and the welfare, morale, and well-being of all persons under their control. The general authority placed on the base commanding officers by Navy regulations gives the commanding officer broad powers to create rules and regulations designed to meet local conditions. Thus, the base commanding officer may exercise police power, in varying degrees, as necessary and as the facts of a situation dictate, over any individual on the reservation. Since all incidents occurring on the base, including those involving juveniles, have an effect upon command morale and safety, the control and handling of incidents is a major concern of the base commanding officer. Masters-at-Arms may be authorized to investigate offenses committed on the installation, regardless of who the suspect may be. The base commanding officer publishes regulations and policies governing the conduct on base of civilian juveniles and dependent juveniles, and enforces them with sanctions, which may range from reprimand and exclusion from the base to termination of the sponsor's on-base quarters. In cases of serious misbehavior, the juvenile maybe prosecuted by appropriate civilian authorities.

Federal Jurisdiction

A number of crimes are Federal violations defined by specific acts of Congress. For example, counterfeiting is a Federal crime, regardless of where it is committed within the United States. In other instances, state criminal laws are “adopted” as Federal offenses under the Assimilative Crimes Act. For state crimes to become assimilated Federal crimes, they must have the following characteristics:

1. Be committed on a Federal reservation or section of a reservation over which the Federal Government exercises exclusive or concurrent jurisdiction.

2. Not be in violation of Federal laws or policy. When juveniles commit serious Federal offenses, the appropriate coordinating agencies may include the FBI,

U.S. Marshals, and the U.S. Attorney's Office. Such offenders may be tried in a U.S. District Court. In certain cases involving minor Federal offenses, the U.S. magistrate may hear the case.

State Jurisdiction

If the offense committed by the juvenile was a state crime and was not committed in an area of exclusive Federal legislative jurisdiction, local police and courts may take action. As this discussion is limited to on-base offenses, it will be assumed that the Master-at Arms will be the first to enter a case and will conduct the investigation unless the nature of the offense falls under the jurisdiction of the NCIS.

Local policies and regulations will determine the extent to which the MA will become involved in disposing of juvenile offenses. For example, on a base where there is concurrent jurisdiction, an MA investigation reveals that dependent juveniles have stolen cigarettes from the base bowling alley. Final disposition could include administrative action or trial by the appropriate civilian court or both, depending on the circumstances of the crime and prior offenses of the juvenile.

Overseas Installations

A difficult problem for the MA on overseas installations is created by juveniles who maybe present. The MAs are faced with the presence of juvenile dependents of United States military and civilian personnel, as well as nondependent juvenile citizens of the host nation.

Juvenile dependents are faced with fewer off-base activities when living overseas with their sponsors. As a result, juvenile delinquency stemming from boredom and inactivity may be encountered. If delinquent behavior takes place off the installation, relations with the host nation may be affected. In incidents occurring on the installation, Masters-at-Arms may become involved in the situation to investigate and refer the incident to the proper authorities for disposition. Minor incidents may be disposed of without formal action. Instead, the parents would be counseled and the youth reprimanded, with a warning as to the consequences of future delinquency. More serious incidents that are detrimental to the command and involve juvenile dependents may result in administrative action being taken. The command has several options available, including the following:

1. Reduction of privileges

2. Suspension of privileges

3. Officially reprimanding the sponsor

4. The return of the sponsor and dependents to the United States

5. Prosecution of the juvenile in host nation courts if the case is serious and upon advice of the local judge advocate

Questions concerning the investigation, apprehension, and prosecution of suspects, or other action to be taken, will require close coordination between security personnel and the judge advocate's office.

Investigation of all offenses committed on overseas Navy installations by juveniles of the host nation is the responsibility of the law enforcement personnel. Normally, local procedures are evolved to solicit the cooperation of the local foreign police in cases involving minor incidents of misbehavior. In cases involving host nation juveniles suspected of criminal offenses committed on the installation, you should carry out normal investigative procedures.

Local procedure may dictate that these offenses will be jointly investigated by both U.S. and host nation law enforcement personnel. The judge advocate should be contacted to determine what apprehension and prosecution procedures may be followed. Because of jurisdictional problems in these cases, the best action is that of prevention.

Adequate provisions should be established to prevent illegal entry of these juveniles onto the installation. Troublesome youths should be referred to local civilian police. In all cases, Masters-at-Arms should be alert for all places and situations that might lead to delinquent behavior involving the juveniles of the host nation and U.S. Navy personnel and property.

AUTHORITY OF LAW ENFORCEMENT PERSONNEL

Law enforcement personnel under authorization of the base commanding officer will investigate all criminal offenses and acts that endanger U.S. Navy personnel, their dependents and property, and U.S. Government property, or that are deemed detrimental to the efficient operation of the U.S. Navy. A considerable portion of the burden for the prevention of juvenile problems rests with the security officer and the security force, since the base commanding officer uses their expertise in dealing with juvenile delinquency problems within the command.

JUVENILE JUSTICE AND DELINQUENCY PREVENTION ACT

Public Law 93415, entitled The Juvenile Justice and Delinquency Prevention Act of 1974, now codified as chapter 403 of Title 18, United States Code was enacted to encourage programs and services designed to prevent juvenile delinquency and to encourage diversion of youthful offenders from the criminal justice system. Among procedures included in the Act are those concerning the processing of youthful offenders, such as apprehension and detainment, and records compiled on juvenile offenders.

Apprehension

When dealing with juveniles, as with other civilians, law enforcement personnel derive their authority as agents of the base commanding officer, rather than by virtue of their positions as military law enforcement officers.

All members of the Armed Forces who are acting in a private capacity have the ordinary right of citizens to assist in the maintenance of peace, including the right to apprehend suspected offenders.

In strictly legal terms, the authority of law enforcement personnel of a base, so far as concerns juveniles who are not subject to military law, is essentially that of a private citizen. As state law varies regarding citizen's arrest, the judge advocate must be consulted for guidance.

However, even in a jurisdiction having very narrow citizen's arrest statutes, a form of implied authority can be relied upon. Upon apprehension, juveniles must be notified of their legal rights, the offense for which apprehended, and be given a chance to consult with parent or guardian or another adult.

The offender's parents or guardians must be notified of the apprehension. The parents or guardians must also be informed of the juvenile's legal rights and the offense for which the juvenile was apprehended

Detainment

Though it maybe necessary to detain juveniles, they are not subject to the *UCMJ*. The detainment of juvenile suspects in confinement facilities, detention cells, or hospital prisoner wards is strictly forbidden at all times.

Juveniles may be temporarily detained in the offices of the base commanding officer or security officer only if all of the following conditions exists:

1. Such detainment is specifically authorized by the installation commander.
2. The juvenile is suspected of a serious criminal offense requiring exercise of jurisdiction by civilian law enforcement authorities.
3. At the time of apprehension the parents are not available to take custody of the child.
4. The detainment is for transferring custody of the juvenile, at the soonest possible time, to the child's parents or to the appropriate state or Federal agency having jurisdiction.

Records

Unless a juvenile who is taken under custody is prosecuted as an adult, law enforcement personnel may NOT do the following:

1. Obtain fingerprints or photographs of the juvenile without written consent of the judge of the juvenile court.
2. Release names or pictures of juvenile offenders to the public. All records pertaining to juvenile offenders must be safeguarded from unauthorized disclosure. During the juvenile proceeding, information on the juvenile and the circumstances of the offense maybe furnished only to the court, counsel for the juvenile, the Government, and others entitled to review sealed records. These other agencies are the following:
 - a. Another court of law.
 - b. Another agency preparing a presentence report for another court.
 - c. Another law enforcement agency if the request is related to an investigation of a crime or a position within that agency.
 - d. An inquiry in writing from the director of the juvenile treatment facility to which the juvenile has been committed by the court.
 - e. An inquiry from an agency considering the subject for a position immediately and directly affecting national security.

As stated, all records concerning juvenile offenders must be safeguarded and released on a need-to-know basis only. If a request for such information is made under the Freedom of Information Act (FOIA), however, only designated members of the command may deny the request. Accordingly, MAs should refer such requests to the FOIA officer, PAO, or SJA as appropriate. It is important that records contain a

detailed description of regulations violated and of further disposition by civilian authorities. Permanent records of nonessential and minor incidents or situations resolved in conference with the parents and juvenile should not be made. When a juvenile is found innocent, the record concerning the offense, including fingerprints, should be destroyed or sealed by the court, or disposed of under local directives of the appropriate state or Federal agency having jurisdiction over the reservation.

JUVENILE OFFENSES

The great majority of Masters-at-Arms' contacts with juveniles occur when youthful military dependents are apprehended while committing, or suspected of committing, relatively minor offenses amounting to a breach of the peace, or when preventing them from committing acts potentially injurious to property or life. Such offenses range from disturbing the peace and disorderly conduct (fights, drunkenness) to traffic violations.

In such cases, the base commanding officer's regulatory authority over dependents normally is exercised through the military sponsor, or the civilian sponsor who is connected with the installation through employment or residence thereon. As military sponsors are in no way subject to prosecution under the *UCMJ* merely because their dependents are guilty of misconduct or criminal offenses, regulation becomes dependent upon matters other than criminal prosecution.

The military sponsor, however, is responsible as a parent, for the conduct of his or her dependents on and off base. For minor first offenses, the commanding officer may find it sufficient to accept payment for damages for property destroyed or stolen and bar the juvenile from using certain base facilities (usually those in which the offense took place). More serious or repeated infractions may call for termination of sponsor's Government quarters and barring of the minor from the base. In addition, the commanding officer has various administrative remedies that may be effectively used against juvenile offenders, such as withdrawal of base auto permits. The CO will make the standards of conduct known not only in base regulations but also by written notice at facilities customarily used by dependents.

In cases involving juveniles from off the base, the commanding officer will dispose of the troublesome youths by ordering them off the base and may prohibit

their reentry. Masters-at-Arms may use only such force as is necessary to eject a person from the installation. The penalty imposed for recentering the reservation after ejection or order forbidding re-entry is contained in Title 18, U.S.C., Sec. 1382, which provides for a fine of not more than \$500 or imprisonment for not more than 6 months, or both.

Legal Action

Occasionally, a more serious criminal offense (larceny, assault, or extensive vandalism) is committed on a military reservation by a juvenile. A base commanding officer does not have authority to order juveniles who have violated existing laws or base regulations on the reservation into confinement. However, an investigation may be conducted and, if warranted, juvenile suspects may then be detained as previously discussed.

Types of offenses

The following offenses are those that occur most frequently on naval bases:

1. Traffic violations. Speeding, reckless driving, and various minor driver violations involving teenage drivers create a special problem of control and prevention. Traffic control on the base usually is the responsibility of security personnel, who should make surveys determining the extent of the problem and enforce necessary measures of regulation. A simple reprimand is often sufficient for first offenders. Some youths, however, persist in driving recklessly on the base. In such cases, their parents should be notified and the commanding officer may suspend the youth's base driving privileges. Troublesome youths from local civilian areas should be forbidden to enter the reservation at all.

2. Disturbing the peace and disorderly conduct. Occasional rowdyism and fighting will inevitably occur when youths gather. In most incidents, security personnel action will consist of stopping the misconduct and when necessary, referring the incident to the parents of the youths involved. Since most juveniles are not of legal alcohol-drinking age, security personnel and investigators must be on the lookout for signs of illegal possession of alcohol. The names of persons and locations of places illegally dispensing alcohol to youths should be given to the security officer and/or local police so that appropriate legal action maybe taken to prevent recurrence. Drug abuse and narcotic problems may also be experienced on base.

3. Juvenile vandalism. Vandalism is the deliberate damaging or destruction of private or public property. Often, this delinquent behavior is committed for fun and excitement (especially by younger children), to express antagonism toward persons or situations (such as problems at home or school), for revenge, and as a kind of violent protest by angry and perhaps frustrated youths who are “mad at the world.” The cure for vandalism lies in determining and removing its causes and in providing constructive outlets for the stored-up energies and frustrations of youths. In all cases, individual juveniles must be shown that such vicious behavior will not be allowed. They (or their parents) should pay for the damage done.

4. Petty theft and burglary. Housebreaking and petty thefts are frequent juvenile offenses. Most times, such acts will involve only a few dollars or the theft of inexpensive or attractive pieces of property (radios, bicycles, cigarettes, candy). The base exchange and snack bar will be frequent targets for juvenile shoplifters. In these cases, informal procedures such as reprimand, notification of parents, and withdrawal of base privileges usually will be sufficient. When a youth is guilty of recurring or serious offenses, legal action may be necessary.

INVESTIGATIVE PROCEDURES

The investigative procedures outlined are intended to apply to less serious first offenders among juveniles and not to adolescent criminals. During your relationships with youthful offenders, you must reflect a concern not only for the future development of the youths but also for their parents, their fellow juveniles, and their community.

Basic Principles

The investigative tasks of detecting and apprehending criminals, preventing crime, and controlling people, within the framework of the law, apply equally to all persons coming under military jurisdiction—including juveniles.

You must ensure that the juvenile is processed in accordance with applicable laws and regulations. Juveniles and their parents must be informed of their legal rights and the offense for which the juveniles have been apprehended.

Both in conduct and attitude, security personnel and investigator must reflect their position as adults interested in the welfare of all youths in the community and their status as law enforcement officers.

Your primary concern is to determine whether a specific act that is a violation of law was committed. The investigation is directed at producing evidence concerning the commission of an act and determining the identification of the offender.

You should determine what the juvenile did and why, though investigation into causes and background data should be limited to essential information.

In juvenile cases, investigative action may be extended to conduct on the part of military sponsors that is dangerous or harmful to a child.

The misbehavior of a juvenile is an offense against the public and not a personal offense against you. Many times, you will be the target of uncooperative, rebellious, insulting, youthful behavior on the part of one or more suspects in a case.

The temptation to “crack down” or to personally discipline a youthful offender must be avoided. Physical punishment, detainment of juveniles in a manner not sanctioned by regulations, and other extralegal procedures are prohibited.

You must establish rapport and avoid doing anything in the personal handling of a juvenile that would justify a rebellious reaction by the youth.

Preliminary Investigation

Investigative procedures for the gathering of evidence in juvenile offenses are identical to those used in investigation of cases involving adult suspects—the evidence required is no less for juvenile cases. Care must be exercised to assure those rights of the children that protect them from unwarranted treatment.

You must notify the parents of a juvenile immediately after detaining or apprehending the youth. Failure to establish parental involvement violates the juvenile’s rights and may hinder immediate corrective action.

You should make available to the parents full facts about the offense in which the juvenile is involved.

You should be alert for those rare parents who demonstrate that they are primarily concerned with shielding the suspect from any and all accusations, regardless of their validity.

In minor incidents, especially those involving children under 16 years of age, the informality of contact of the investigator with the juvenile may require no formal procedures, and corrective action may consist of a simple warning.

Interviews and Interrogation

Investigative procedures in connection with juvenile criminal offenses often involve interview and interrogation of young people, victims, witnesses, and suspects. The general techniques of interviewing and interrogation were described earlier in this chapter. Take certain precautions in questioning juveniles.

In any questioning of a juvenile, the following guidelines apply:

Obtain the juvenile's confidence by allowing him or her to take care of immediate needs. To get the interview started, establish a bond of mutual interest or experience. Meet the juvenile with consideration and be friendly. Many juveniles feel that the world especially the adult, is against them.

In obtaining personal information, explain why the information is necessary. Intersperse your data with his or hers so as to keep the interview going and provide yourself a check on the validity of the juvenile's answer. Never allow the juvenile to turn the tables and ask you questions. It also may be desirable to keep the juvenile guessing as to how much you know, by your not saying too much during the interview. The juvenile must be told, however, of what he or she is suspected, in addition to other Miranda rights.

An interview or interrogation of a female juvenile by a male investigator should only be conducted in the presence or constant hearing of a witness, preferably female.

Excessive psychological force, such as abusive language, threats, or harshness, produces only one result: you make your own job harder. It might also subject you to disciplinary action, or even to personal civil liability. To get a complete and accurate story, you must avoid alienating the juvenile.

Avoid "get-tough" attitudes or loss of temper. Investigators are not prosecutors.

In interrogating juveniles, you must avoid any coercive practices, and any act which would make it likely that an innocent, but frightened or emotionally disturbed child would confess.

Avoid using condemning terms, such as *juvenile delinquent*, *thief*, and *liar*.

A number of interview techniques used by civilian agencies have been found to be effective in dealing with youthful offenders. Among these techniques are the following:

1. Approach— Your approach should be honest and straightforward. Preconceived feelings and hostilities on both sides should be aired at the beginning. During this initial opening, you should carefully evaluate the subject and seek an approach that will create meaningful communications.

2. Language— Slang, street language, or a falsely assumed level of English that you are uncomfortable with will appear phony. Unless you are comfortable with youthful expressions, they should be avoided.

3. Questions— A truthful answer to all questions should be given. Questions should contribute to the course of the interview and not divert from it.

4. Personal experiences— The limited use of personal experiences by you may convince the youth that his or her position is understood and may tend to lower anxiety.

5. Control— The juvenile may test your sincerity by being uncooperative, telling obvious lies, or by using abusive language. If this occurs, you should make it known that the youth's efforts are obvious, and then attempt to identify the motivation behind them.

6. Self-respect— Avoid placing the youth in a situation where a loss of self-respect is likely to occur. Rationalizations and defense mechanisms can be very important, particularly in the young. The loss of these defenses may, in the long run, prove to be harmful.

7. Selection of alternatives— During the interview, both the juvenile and the parents should be made aware of the alternative courses of action available to the commanding officer. The juvenile, in particular, should have a major say in selecting one of the alternatives, as it will then be more meaningful.

8. Emotional outbursts— Emotional outbursts, closed eyes, dropped heads are all indications that progress is being made in discovering the causes behind the problem. At this point, the juvenile is often vulnerable to the establishment of a good relationship with you and a meaningful discussion.

You should always give consideration to having cooperative parents present during interviews or interrogations. You may give the parents an idea of what questions are going to be asked and allow them to ask their own questions at a given time. They should be told not to interrupt during the questioning. You should consider the advisability of conducting the questioning in the juvenile's home.

Contacting juveniles at school should be avoided if possible. However, if it is necessary, certain precautions must be observed.

1. Contact a key official, such as the school principal, and explain your purpose. Do not contact the student's teacher first.

2. Investigators, and particularly uniformed personnel, should not contact students at school during hours when it is likely they will be seen by large numbers of other students.

3. Remove a child from school only as a last resort. If a student is to be apprehended, explain this to school officials and obtain their permission to remove the child from school.

4. If possible and convenient, request a room in the school for questioning the suspect. Never enter the classroom to apprehend or question a juvenile.

If you should find it necessary to conduct an interview while the juvenile is in public view, especially when there are other juveniles present, the following precautions should be observed:

1. The juvenile subject must be allowed to "save face" with the group. If you act too officiously, you may embarrass or anger the youth and ruin the chances of a successful interview.
2. Speak quietly and inconspicuously.
3. Act casually as if you know the subject personally.

INTERNAL INVESTIGATION MANAGEMENT

LEARNING OBJECTIVES: List six training elements for investigative duty. Identify seven questions to be asked in investigative operational management planning. Describe the elements to be considered in the assignment of investigative personnel.

While investigative assignments must be based on aptitude and individual desires, all Masters-at-Arms should have knowledge of basic investigation techniques rather than being specially trained investigators. Your training should include, at the minimum, the following:

1. The scope of the Master-at-Arm's investigative responsibility

2. The provisions of the *UCMJ* that govern investigations

3. Preservation and examination of crime scenes and evidence

4. Rules of search and seizure

5. How to conduct interviews

6. How to write reports

OPERATIONAL MANAGEMENT

The supervisor of an investigation unit should be able to evaluate performance, eliminate unnecessary jobs, and make sure that the available resources of time, personnel, and equipment are used to maximum efficiency. That is called investigative operational management, and it must be applied properly to allow the investigator to fulfill his or her obligations.

Investigative operational management planning considers the following questions:

1. What is to be done?
2. Why is it to be done?
3. When is it to be done (what priority)?
4. Where is it to be done?
5. How is it to be done (resources)?
6. What is the estimated man-hour time?
7. Who is to do it?

As a part of the planning process, the supervisor considers all foreseeable contingencies and develops plans and SOPs so that the unit is prepared to respond.

UTILIZATION OF PERSONNEL

People are the most valuable resource available to the investigative supervisor, and they should be used wisely. The supervisor considers the following in the management of personnel resources.

Qualifications. Who is best suited for the mission in terms of experience, training, skill, physical condition, and dependability? The supervisor should assign the task to the right person.

Case Load. The case load is distributed evenly among assigned investigators. Careful planning is required to fit the individual to the task without overburdening the more experienced personnel. Difficult tasks should be alternated with the more simple

so that one or two investigators do not always receive the hardest, most time-consuming investigations.

Pairing Investigators. Efficiency can be greatly increased by properly pairing investigators—the inexperienced with the experienced and the methodical with the compulsive.

Time. The time that is required for an investigation should be considered so that the investigator is allowed a reasonable period to accomplish an investigation. Time is also considered in other ways; for example, does the investigator have sufficient time to rest, or is he or she overworked and subsequently less effective?

Supervision. The supervisor provides central direction to the investigative effort and, above all, assists the investigator whenever and however possible. The successful supervisor thoroughly briefs subordinates on requirements and delegates authority as appropriate.

SUMMARY

In this chapter, we covered investigative jurisdiction, major and minor criminal offenses, and security matters that require investigative action. The types of criminal information were defined, followed by an examination of the criminal information process. Next, we looked at informants and their importance to the investigative process, along with a discussion of the techniques used in observation, description, and identification. The terms used in surveillance operations were defined, followed by a discussion of planning, personnel qualifications, methods, and precautions involved in surveillance operations. The difference between an interview and an interrogation was discussed, and the elements of each technique were considered. Finally, we covered investigation of juvenile offenders and the management of internal investigations.

CHAPTER 16

FORENSICS

This chapter contains scientific and technical subjects and describes various technical skills and techniques required to develop the facts of an investigation.

FINGERPRINTING

LEARNING OBJECTIVES: Define some of the terms used in classifying or describing fingerprints. List the steps required to obtain good fingerprints. Explain how fingerprints are found, processed, and classified. Explain the importance of accurate fingerprint records.

Fingerprints are the most positive means of identifying individuals. The ridges on the skin of the palmar surfaces of the hands and the plantar surfaces of the feet are commonly referred to as papillary or friction ridges. These ridges form on the fetus before birth and remain unchanged throughout life, and even after death until decomposition of the skin destroys them. Damage to the skin during a person's life maybe either temporary or permanent. Abrasions and slight cuts that do not permanently affect the skin are corrected in time by nature, and the ridges reappear as they existed before the damage occurred. Deep cuts and injuries affecting the innermost sections of the skin will result in permanent scars but the general pattern will continue to exist.

The information given in this text is designed to assist you in applying correct fingerprinting techniques and processes in the field. It does not include procedures used to identify subjects by fingerprints, or the classification of fingerprints. Assistance required beyond the information contained in this text requires more technical considerations. You should seek such help from an investigation laboratory, or from others who are qualified as fingerprint classifiers with the Federal Bureau of Investigation (FBI) or with local civilian police organizations.

Some of the terms used in classifying or describing fingerprints are as follows:

Bifurcation— the forking or dividing of one ridge line into two or more branches.

Core— the approximate center of a fingerprint.

Delta— that point on a ridge at or in front of, and nearest the center of divergence of the type lines.

Divergence— the spreading apart of two ridges that have been running parallel or nearly parallel.

Focal points— the delta and core located within the pattern area of loops and whorls, and used to classify them.

Palmar— pertaining to palm impressions of the hand.

Plantar— pertaining to sole impressions of the foot.

Pattern area— that part of a loop or whorl in which appear the cores, deltas, and ridges, with which classification is concerned.

Point— a ridge characteristic formed by one of the three basic ridge characteristics—bifurcation, ridge ending, or dot.

Ridge— elevated portions of skin that make the print. They result from the fusion of separate skin layers. Sweat pores run in single rows along the ridges and are deposited on a surface when a print is made.

Shoulders— the points at which the recurring ridge of a loop-type pattern definitely turns inward or curves.

Type lines— the two innermost ridges that start parallel, diverge, and tend to surround the entire pattern area.

The terms used in searching for or taking fingerprints include the following:

Latent print— used to describe all traces of prints found on items of evidence or at a crime scene. (The term was once used for invisible prints; however, modern police terminology uses it for all chance or unintentional prints.)

Record prints— inked finger, palm, and sole impressions obtained from a person for identification purposes. They may be obtained either directly from the person or from official files.

Major case prints— a complete set of record prints obtained from an individual, including, but not limited to, fingerprints, palm prints, edges of the hand, fingertips, and the entire finger. Major case prints are usually obtained in all investigations of serious offenses.

TAKING FINGERPRINTS

Taking good, clean fingerprints is not difficult. To be classified, a good fingerprint impression should be dark gray in color and free of smudges. All that is required to obtain good prints is practice.

Steps in Taking Fingerprints

To help you obtain the best set of fingerprints possible, use the following procedures:

Initial steps. First, have the subject sign the fingerprint card. Next, have the subject wash his or her hands to remove any dirt particles. Ensure that the fingers are free of lint from towels used to dry the hands.

Inking. There are various inking methods that a Master-at-Arms may encounter. The ink and glass method, the porelon pad, and the inkless system are the most common. The mechanics of rolling fingerprints is the same for all three methods.

Rolled impressions. Rolled impressions are made by rolling the finger or thumb from nail edge to nail edge. They are made to show the entire friction surface of the finger or thumb, from the tip to one quarter inch below the first joint. Figure 16-1 shows the necessity for a fully rolled impression. Views A and B are impressions of the same finger. The finger in view A of the illustration is rolled fully and properly and reveals that the pattern is what the classifier calls an accidental whorl. View B shows that the finger is only partly rolled, leaving barely enough of the pattern to lead the classifier to believe it is a tented arch. The larger surface of the fully rolled impression not only allows accurate classification but it also gives more points for comparison.



Figure 16-1.—Fingerprint impressions.

There is a specific method of rolling the subject's fingers or thumbs in the ink and onto the fingerprint card to ensure a good impression.

The basic premise is to roll the fingers or thumbs from awkward to comfortable.

To illustrate this, hold your hands in front of you with the backs of your hands together. Now roll them around so that the palms are together and the thumbs are up. You will see that the right hand moved clockwise and the left hand moved counterclockwise. This is the direction the fingers on each hand should be moved. Thumbs are moved in the opposite direction of the fingers.

The person taking the prints should grasp the top of the subject's hand and ensure that the finger to be printed is extended (See fig. 16-2.) The roll is a single movement with only enough pressure to provide a clear print. The subject being printed should be told to look away from the fingerprint card and to try not to "help" the roll. This will reduce smudging and produce a clean impression.

Plain impressions. Plain impressions are made on the card by simply pressing the four fingers on it at a slight angle. (See fig. 16-3.) They should be showing the tips to one-quarter inch below the first joint. Thumbs are then printed by simply re-inking and pressing them on the block next to the plain finger impressions. The purpose of plain impressions is to verify the order of the rolled impressions and to show certain characteristics that are sometimes distorted in the rolled prints.

The subject's fingers are held straight and stiff. The hand should be level with the wrist. The person taking



Figure 16-2.—Printing a rolled impression.

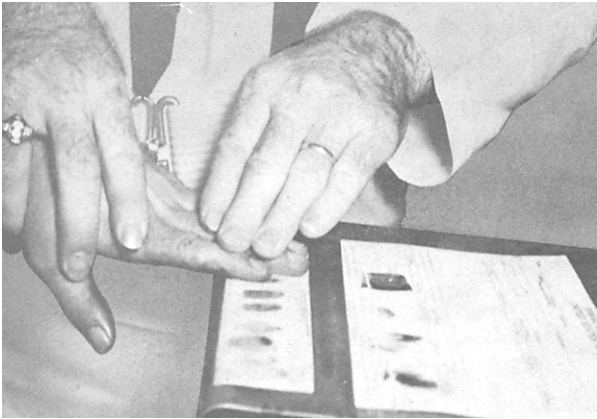

99.25

Figure 16-3.—Taking plain prints.

the prints should grasp the wrist with one hand and press the fingers onto the cards with the other hand.

Final step. After the printing procedure is completed, the person taking the prints should complete the information on the fingerprint card. There should be facilities nearby for the subject to clean the ink from the fingers.

Other Types of Prints

In addition to fingerprints, a case may require the application of additional techniques. Some of these are discussed in the following paragraphs.

Photographic print impressions. The use of glossy photographic print paper and photographic developer makes a highly detailed print. It is limited to comparison purposes where extremely fine detail of a print is required. The fingertips receive a light application of the developer and then are rolled on the photographic paper. The paper is then placed in a fixing bath for approximately 30 seconds and washed the same as an ordinary photograph.

Palm prints. It may be necessary to obtain palm prints from a subject since the whole hand also makes a distinctive impression and these types of prints might be found on evidence or at a crime scene. The biggest problem with making palm prints is that often the hollow part of the palm is not adequately printed

The best method of recording palm prints is to wrap printing paper around a tubular object and then place the heel or base of the subject's palm on the tubular object and roll the print in a pulling motion from the heel of the hand to the fingertips. (See fig. 16-4.)

Major case prints. These are made in the course of investigating serious offenses. They are often helpful in forgery investigations since the side of the hand is printed. (This shows the impression of a hand in the writing position.) In effect, prints are made of all parts of the hand to include the tips, palm, sides of the fingers, and sides of the palm. If necessary, the same procedures may be used to make prints of the feet.

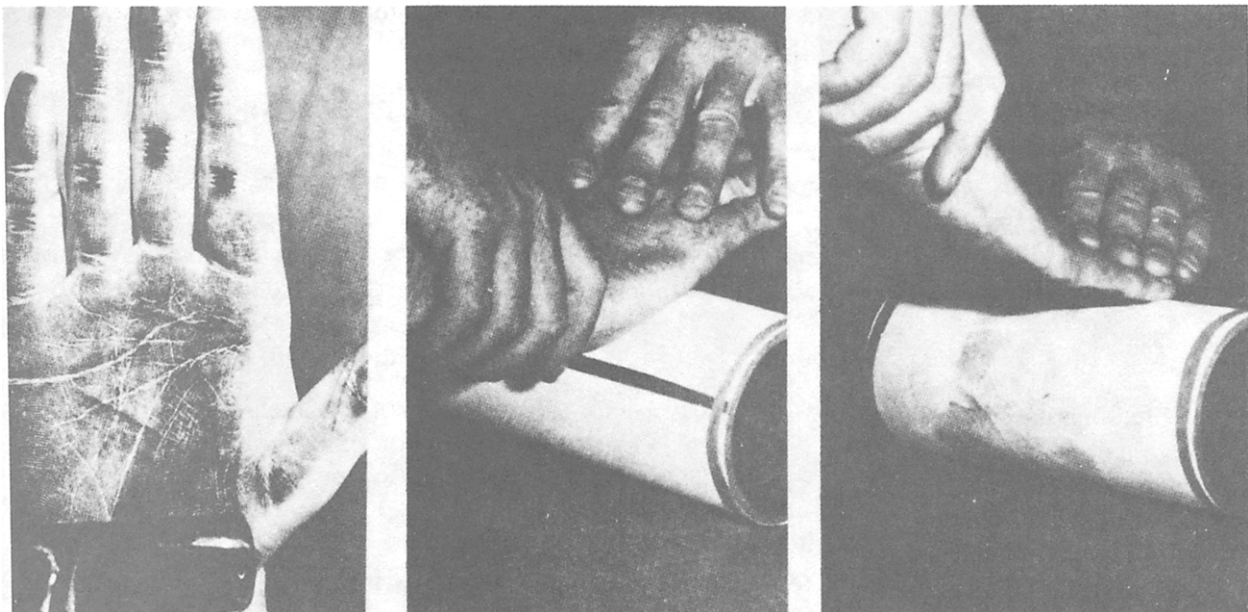

193.102

Figure 16-4.—Taking palm prints.

Problem Prints

Problems often arise in obtaining a good set of prints. Some of these problems are discussed in this section.

Dry or soft skin. Certain people have dry and rough hands because of their occupations. Rubbing the tips of the fingers with oil or creams will often make the fingers pliable and soft enough for clear, unsmudged prints to be made. Holding ice against the fingers will sometimes help if the ridges are fine and small and the skin is soft—as is often the case with children or women.

Deformed fingers or hands. If the hands and fingers are so deformed that the regular printing procedure cannot be followed, prints can be made by applying the ink directly to the fingers with a spatula or small roller. A square piece of paper is rotated around the finger. When a satisfactory print has been made, this square is then taped to the appropriate box of the fingerprint card.

In cases where there are extra fingers (usually little fingers or thumbs), the innermost five are printed on the card, and the extra digit is printed on the reverse of the card.

Webbed fingers are printed as well as possible in the roller and plain impressions.

In cases where the finger or tip is amputated a notation of that fact is made in the appropriate box. (Example: “AMP” 1ST JOINT, FEB 1943 or “TIP AMP.”)

Excessive perspiration. Because of the subject's excessive perspiration, some inked impressions will be indistinct. Wipe each finger with a cloth and immediately ink and roll the finger on the fingerprint card. Follow this process with each finger. It is also possible to wipe the fingers with alcohol, benzine, or similar fluid that would act as a drying agent.

Poor Impressions

Poor impressions usually are caused by one or more of the following mistakes:

1. The use of poor, thin, or colored ink resulting in impressions too light or too faint or with obliterated ridges. Best results are obtained by using heavy, black printer's ink. This is a paste, and it should not be thinned before using. It dries quickly and does not blur or smear in handling.

2. Failure to clean the person's fingers thoroughly before inking. If foreign matter (or perspiration) adheres to the fingers, false markings appear and characteristics disappear.

3. Failure to clean the inking apparatus after each use.

4. Failure to roll the fingers fully from one side to the other and failure to ink the entire finger area from tip to below the first joint. Such failures result in important areas not appearing on the print. The impression should show the entire finger, from the first joint to the tip, and from one side to the other side.

5. The use of too much ink, resulting in the obliteration of ridges. Just a touch of the tube of ink to the plate is sufficient for several sets of prints. It must be spread with a roller into a thin, even film.

6. The use of too little ink, resulting in ridge impressions too light and too faint for tracing or counting. If light or faint impressions occur when using a porelon pad the pad needs to be replaced.

7. Slipping or twisting of the fingers, causing smears, blurs, and false patterns. Hold the fingers lightly, using little pressure, and caution the person against trying to help. Ask him or her to remain quiet and relaxed.

By following the foregoing instructions closely, you can make clear fingerprints that can be classified quickly and accurately. In police work, it is often important that fingerprints be classified quickly for identification. Identification cannot be made quickly, however, if the quality of the prints is unsatisfactory. Make the prints right the first time!

FINDING AND PROCESSING PRINTS

The first law enforcement personnel to arrive at a crime scene must be “fingerprint conscious” and protect the scene to prevent fingerprint or other fragile evidence destruction until the scene can be processed. Persistence, determination, and imagination by the crime scene investigator will be most rewarding.

All persons not absolutely necessary to the conduct of the investigation should be excluded from the area of the crime scene to prevent inadvertent destruction of evidence.

Finding Fingerprints

Many uninformed persons have the mistaken belief that an attempt to obtain prints would be unrewarding

and unsuccessful because of the physical nature of the object, or the object having been subjected to adverse conditions. Intelligent and persevering attempts to obtain prints and other trace evidence should be made under all circumstances. Smudges that have been left by fingers having grease, blood, or other foreign substances on them, but lack ridge characteristics, are not serviceable as latent prints. However, they should at times be considered as other types of trace evidence.

Latent prints fall into three general classifications: (1) visible prints made by a finger coated with a foreign substance such as blood, grease, dirt, and so forth, and plainly visible; (2) plastic impressions found impressed in pliable substances such as butter, candles, putty, and semidry paint; and (3) invisible or semi-invisible prints made by natural body secretions on the hands and fingers.

Visibility of latent fingerprints depends upon the physical condition of the person leaving the print, surface of the object, angle of reflection of the light by which they are viewed, time elapsed since they were placed, amount of heat to which they have been subjected, and other factors.

The amount of time they will remain on an object is also to some extent dependent upon atmospheric conditions, air currents, and humidity.

It is logical to start the examination of a crime scene for fingerprint evidence at the point of entry. Other possible points of entry should not, however, be overlooked since futile attempts may have been made there. The search continues in the same manner as for other evidence.

A strong oblique light is a great aid to the investigator in discovering latent fingerprints.

Always note exactly where latent prints are found and their location on the object on which they are found. The angle they assume might indicate how an object was held or what position the hand was in when the print was made.

Sometimes, when picking up a heavy object located close to a wall, one will place a hand on the wall as a brace. This location should not be overlooked when processing a crime scene. The same applies to countertops and other flat surfaces upon which a subject may lean without actually moving the object.

The undersides of heavy objects such as tables, chairs, and other furniture should not be overlooked as possible sources of latent prints since it is natural for finger contact to occur when lifting or moving them.

Numerous prints may be found at the scene and all should be preserved—any unneeded ones can be discarded later.

A notation as to exactly where the latent print was found, its position, when it was found and by whom are most important points to record. Any slight mistake by the investigator, when testifying in court, might result in the elimination of the evidence from consideration.

When a latent print is found, the first—always the first—thing that must be done, is to photograph it. Various photographic techniques consisting of reflected light at various angles, filters, and different types of film may be required to obtain a photograph of value.

The use of back-lighting through a pane of glass has been very successful with the faintest of latent prints.

Cameras having a fixed focus and termed *fingerprint cameras* are not available through supply channels and should be ordered as an open purchase item. A view camera is most versatile. By being able to see the latent print through the camera lens under varying conditions of light, the investigator can determine the best procedure. By stopping the lens down, good readable prints can be obtained from curved surfaces with the view camera. This type of camera is highly recommended.

Also, always include a ruler in photographs of fingerprint evidence.

After a print has been photographed other methods of preserving the print maybe attempted

Visible prints made with some foreign substance on the fingers can often be lifted with fingerprint-lifting tape. If these types of latent prints, as well as the plastic type of latents are on small objects, the entire object may be retained and held as evidence.

Latent prints made with just the normal secretions of the skin will usually have to be processed in a special way before they can be of any real value. Perspiration is about 98 percent water with the remaining percentage composed of fatty acids, urea, sodium and potassium chlorides, phosphates, carbonates, sulphates, lactic acid amino acids, and traces of many other substances. These substances lend themselves to various types of treatment. The most frequently used processes are powdering and chemical treatment.

Powdering

Fingerprint powders are supplied in field kits in several colors, but black, gray, and dragon's blood are

the most frequently used. The commercial powders have been developed over many years. They are dependable and of the proper composition. Choosing the powder that best contrasts with the background is a good rule of thumb to follow. Dragon's blood has the advantage of showing up on either a dark or light background. However, the choice of powder depends upon the objective of the investigator—whether the latent print is being developed for photographing or lifting. A test should be made of the area selected for the test print. First, it should be lightly brushed with powder to see if any unseen latent fingerprint is actually present. Then the surface can be wiped clean and the test print made and processed

Fingerprint powder can be applied with fiberglass, camel hair, and feather brushes.

A large piece of cotton can be used for developing latent prints over a large area.

Several law enforcement agencies have adopted a procedure for lifting latent prints by using an extremely fine metallic powder and magnetic wand. The unit is called a Magna Brush although no bristles are present. The magnet picks up the powder, and only the powder touches the latent print, reducing the possibility of destroying ridge detail as is possible with a bristle brush. Excellent prints have been developed on wood leather, paper, and even cleansing tissue by using the Magna Brush. However, the Magna Brush process is comparatively expensive, and good results can be obtained with the normal techniques and equipment.

With ordinary fingerprint powders a technique that has been very satisfactory for developing latents on paper, especially if the prints are fresh and the paper only semiglazed, is to allow the powder to slide back and forth over the paper without brushing. Brushing has a tendency to disturb the fibers of the paper and destroy detail.

The key to successful powder development is to use a small amount of powder with a delicate touch.

A portion of the powder should be poured out of the container onto a sheet of paper. The ends of the brush bristles should be just touched into the powder. Then the excess powder should be shaken off.

A smooth stroke, using the fingers to guide the brush over the suspected area or over the barely visible print, is the technique to adopt. When sufficient ridge detail has been developed so that the direction of flow of the ridges can be observed, the brushing, if continued,

should follow the ridge flow. When the ridge detail has been developed it should be photographed.

After the print has been photographed if desirable, the powdering can be continued to bring the print up into greater visibility. It may then be advisable to photograph it again.

Occasionally, in spite of all precautions, the powder will adhere so tenaciously to the object on which the latent is found that brushing will not remove the excess powder. If so, the first lift is used to remove the excess powder and the second to preserve the fingerprint for identification purposes. Sometimes a latent print may be improved after the initial lifting by additional processing with brush and powder.

Partial prints should be marked for orientation. For example: Which is the tip end? From its location and if other fingerprints or fingermarks are present, it may be possible to determine which finger of which hand made the latent.

If two or three prints are available, it is nearly always possible to determine which fingers made them.

Fingerprint equipment may include fluorescent powders for developing latent prints on multicolored surfaces, but these powders are not normally a component of issued kits. A source of ultraviolet light is required. Synthetic powders are the best fluorescent powders, but natural minerals can be used. Only long-wave ultraviolet light should be used; a short-wave ultraviolet light is harmful to the eyes and skin. If short-wave ultraviolet is used the investigator should wear protective goggles and clothing. Inasmuch as latent prints are normally lifted the use of ultraviolet powders is infrequent.

Nonflammable objects may be passed through smoke of a burning piece of pine wood. A black, even deposit of soot will form on the object, and careful brushing will often result in developing old latent prints.

This procedure may also be used to acquire a small supply of black powder when in the field without proper powders. By removing the accumulated smoke particles from time to time, sufficient powder may be obtained to process latent prints. This process should be used for developing latent prints after attempts with brush and powder have failed.

Lifting Fingerprints

The most common materials used for lifting latent fingerprints are rubber lifters and transparent lifting tapes.

Rubber lifters store well and come in both black and white for use with different colored powders. A lifter large enough to cover the print, while leaving plenty of room, should be used. The plastic cover should be carefully removed in one steady movement since any pause will result in a line being left on the tape. In most cases, the powder on the print will not stick to the line, possibly ruining the print.

Apply the adhesive side of the tape to the powdered print, press it down evenly, and then peel the tape from the surface in one smooth, even motion. Replace the plastic cover on the tape over the lifted print to protect it. Rubber tape is better than transparent lifting tape for taking prints from curved or uneven surfaces.

Transparent lifting tape has the advantage of presenting the lifted fingerprints in the correct position rather than reversed as on the rubber tape. The tape is available in dispensers, which speed up the lifting process. Prints on transparent lifting tape should be mounted on material with a color contrasting with that of the lifting powder.

When lifting a print with either transparent or rubber lifters, care should be taken to preclude the formation of air bubbles under the lifter. Keeping a quarter twist on the tape with one hand while rolling it flat with the other will help prevent air bubbles.

Latents found in dust should first be photographed, then lifted. They should not be powdered, as that would destroy them.

Ordinary transparent tapes used in the home or office are not really suitable for lifting fingerprints; however, they may be used as a field expedient. Other available lifting materials are white and black opaque lifting tapes, which are applied like rubber lifters. There are also hinged lifters with transparent tape and white and black backings, which are used in the same manner as lifting tape.

Chemical Processing

All chemical processes should normally be performed at a laboratory. The numerous chemicals, their mixtures, and various applications to different types of evidence are best accomplished by the laboratory technicians. Federal regulations specifically govern the handling of dangerous, toxic chemicals.

All paper products suspected of bearing latent fingerprints are best developed with chemicals. Paper acts as a blotter when touched; therefore, the latent prints will not rub off as they do on a nonporous surface.

Latent fingerprints are developed when the chemicals react with the organic and inorganic chemical substances of latent print residue.

All chemical processes are dependent upon the presence of mineral organic matter in the perspiration. Since its composition varies, not only between individuals but from time to time in the same individual, perspiration accounts for the uncertainty and characteristic "spotty" development of chemical processes.

A frequently used chemical process is the silver nitrate method. A 3-percent solution is recommended but it may be weaker or stronger. One and one-half teaspoons of silver nitrate to a pint of distilled water will make about a 3-percent solution. Tap water generally contains undesirable chemicals that will partially neutralize the silver nitrate.

An object containing fingerprints does not have to be soaked-just wet. After wetting with the nitrate solution, the object is blotted to remove excess solution. The object can be placed under ultraviolet light, sunlight, or photofloodlight. Under ultraviolet, the images appear quickly; they appear less quickly with the photoflood. The object itself will continue to darken with prolonged exposure, to the point where the print images are obscured.

If it is desirable to clear the object it may be placed in a 3-percent mercuric nitrate solution.

After bleaching and washing, a document is placed between sheets of blotting paper and ironed with a moderately hot iron. The blotting paper is turned occasionally to dissipate the steam.

Continuous observation of the object is required during the time of light exposure to ensure that the latent prints do not overdevelop. Latent prints developed with silver nitrate should be photographed immediately and then protected between two sheets of black paper. To preserve prints developed by the silver nitrate process, the object may be subjected to the action of an ordinary photographic fixing bath. The amount of contact and the amount of pressure exerted by the fingers are two variables that affect paper latents the most.

Old fingerprints on paper can best be developed by using ninhydrin. It is a patented product available in spray cans from fingerprint supply houses. It develops latent prints, which appear pink to purple with good ridge detail. The vapors of ninhydrin are toxic; care should be exercised in its use.

It may also be available for use in white powder form, which must be mixed with one of several solvents. The choice of solvents depends upon the particular need of the user. The liquid solvent has no effect on the latent print and is used only to dissolve and dilute the chemical powder. Most solvents used may cause ink to run or to smear. For this reason, it is advisable that evidence that contains hand printing, writing, or typing be processed through the document division to analyze the handwriting before it is processed with ninhydrin solution.

Some prints developed with ninhydrin may appear immediately after processing, while others may take several hours or even days to develop. Ninhydrin may be removed from documents by using a 1- to 3-percent solution of diluted ammonia.

A metal object held over a piece of burning magnesium ribbon will have deposited on its surface a film of white magnesia powder. Latents developed in this way are very persistent, and even scrubbing has failed to entirely obliterate a print developed in this manner.

The iodine method of developing latent fingerprints uses iodine vapors which are physically absorbed into the grease and oil deposits in the print. When the object is porous, such as paper or unpainted wood fuming with iodine is preferred. This is not to say that fuming painted wood and other nonporous surfaces is precluded; sometimes it is even more effective than powder. But soft porous surfaces lend themselves more readily to the iodine process.

Iodine is not only very satisfactory for fresh prints on paper, but also on glass, finely woven fabrics, shiny-skinned fruits, cartridges, silver, and "greasy" prints.

The iodine fuming gun supplied with a fingerprint kit is ideal, but one can be easily made from any glass tube of about 1/2-inch diameter or a little larger. Iodine crystals are introduced into the tube and held in place by a suitable material, such as glass wool. Fumes are produced by exhaling through the glass tube.

A drying agent such as calcium chloride is used to remove moisture from the breath before it passes over the iodine crystals. The calcium chloride is also separated from the iodine crystals and held in place by the glass wool. If some substance such as calcium chloride is not used to absorb the moisture in the breath, droplets of iodine-stained water may drop from the end of the tube onto the object.

The heat of the breath causes the iodine crystals to vaporize faster than they would in the air, producing a usable volume of iodine vapor which is played over the suspected area.

As soon as a print is suitably developed, it should be photographed. No attempt should be made to lift the print with lifting tape. This applies to powder-developed prints on paper as well because the tape will tear the fibers of the paper.

If it is desirable to preserve the iodine-developed print, the paper may be placed between two pieces of glass and the edges of the glass sealed with masking tape.

It is also possible to lift an iodine print using a thin plate of silver. The polished silver should be held against the developed print for a few seconds and then subjected to the light from a photoflood lamp. The ridges where the iodine was in contact with the silver will turn black and be permanent. The silver plate may be cleaned with "whiting" (a finely powdered chalk) for further use.

Ammonia fumes will clear iodine-developed prints. In addition to ammonia, a weak solution of photographic fixer, 15 grams of sodium triosulphate to a pint of water, may also be used to clear iodine-developed prints from paper. The paper should then be washed and ironed. In this procedure, as with the silver nitrate process, care must be taken to ensure that the paper will withstand wetting and washing.

The fuming gun must be well cleaned after each use. Also, you should take care to make sure that no loose iodine crystals are in the kit and that iodine crystal containers are tight. Iodine vapors are very corrosive and will attack metals and other parts of the kit. A common and recommended practice is to keep the iodine crystals separate from the kit until they are needed for immediate use.

A product called Driodine has been developed. It is porous ground glass saturated with iodine. The resulting powder permits actual iodine dusting without the problems normally associated with using pure iodine. Driodine is simply poured over the surface under examination and left from 15 to 30 seconds to produce an iodine-developed print. This method can be used in lieu of or in addition to iodine fuming.

Another method for developing latent prints on flat, porous surfaces through application of iodine is with the use of photographic film. The film is completely exposed and developed. When needed, it is moistened

until the emulsion becomes tacky and is then pressed against the iodine-fumed print. The film is then dipped in a mixture of chrome alum and nitric acid. This mixture dissolves the silver background which is not protected by the silver iodine, leaving a fingerprint that may be compared directly or used for making photographic prints or enlargements.

PATTERNS AND CLASSIFICATIONS

Every investigator should be familiar with the basic fingerprint pattern types to improve the quality of inked impressions taken for submission to identification bureaus. Fingerprints and major case prints taken for comparison with latent prints should always be as clear and complete as possible.

The basic characteristics in a fingerprint pattern are type lines, deltas, and the core. There are other finer

points of distinction to be made in determining exactly what constitutes a particular pattern a trained classifier will use in classifying the print.

Classification Designation

Fingerprint patterns have three basic classification designations. They are further classified into eight different types as follows:

Basic Designations

<u>Arches</u>	<u>Loops</u>	<u>Whorls</u>
Plain, Tented	Ulnar, Radial	Plain, Central Pocket, Double Loop, Accidental

In plain arches, figure 16-5, view A, the ridges enter on one side of the impression and flow or tend to flow out the other side with a rise or wave in the center.

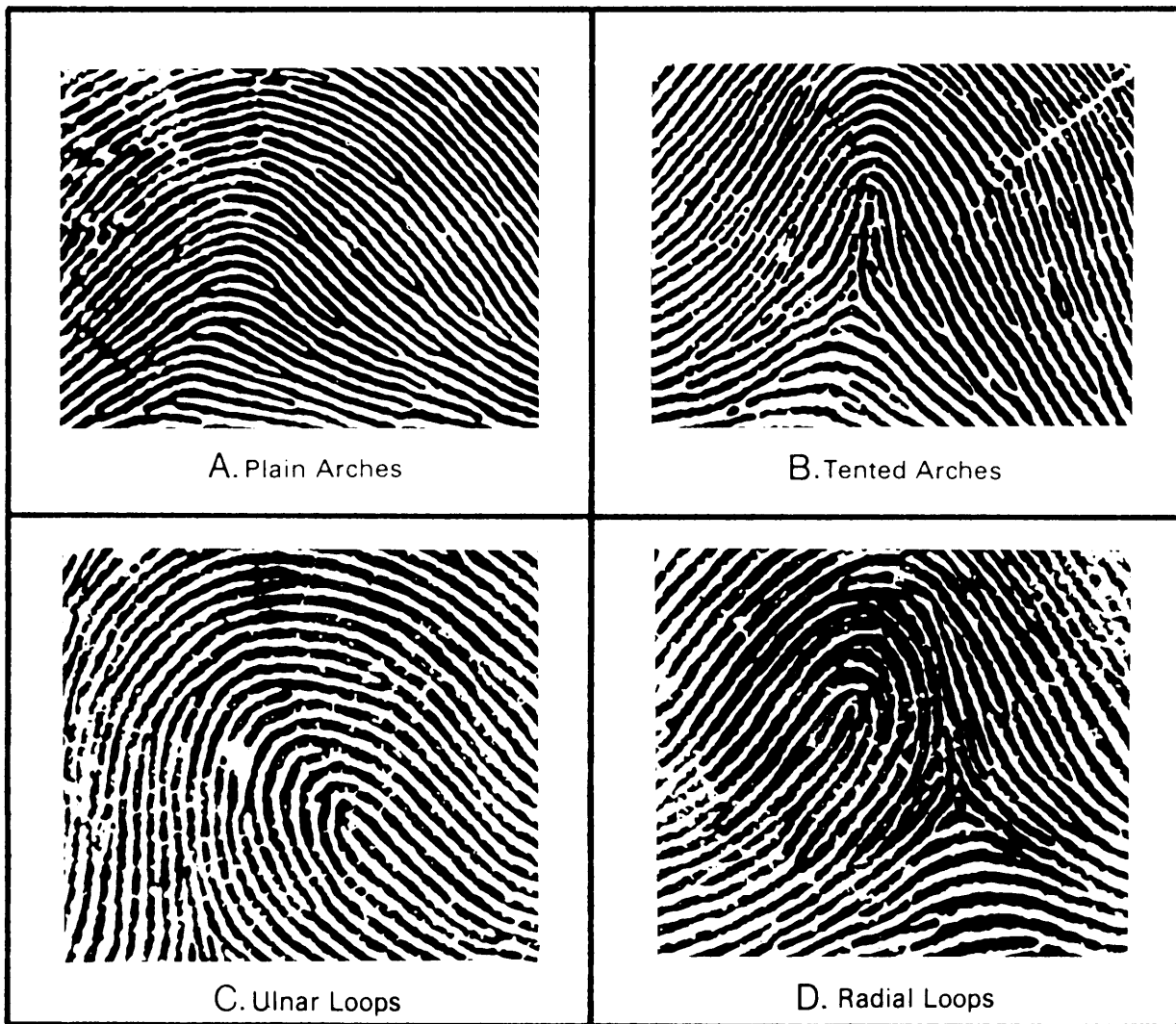

Figure 16-5.-Fingerprint patterns

Tented arches, figure 16-5, view B, are similar to plain arches with the exception that the ridges in the center form a definite angle; or one or more ridges at the center form an upthrust; or they approach the loop type, possessing two of the basic characteristics of the loop but lacking in the third.

A loop has one or more of the ridges enter on either side of the impression, recurve, touch or pass an imaginary line drawn from the delta to the core, and terminate, or tend to terminate, on or toward the same side of the impression from which the ridge or ridges entered.

The loop must have three essential characteristics—a sufficient recurve, and its continuance on the delta side until the imaginary line is reached; a delta; and a ridge count of at least one. The classifier divides loops into two types—ulnar and radial.

Ulnar loops, figure 16-5, view C, are those types of patterns in which the loops flow in the direction of the little fingers.

Radial loops, figure 16-5, view D, are those types of patterns in which the loops flow toward the thumbs.

Whorls are those types of patterns in which the ridges form concentric circles or spirals or some variant of this geometric form. They are divided into plain whorls, central pocket whorls, double loops, and accidental whorls.

A plain whorl, figure 16-6, view A, has two deltas and at least one ridge making a complete circuit, which may be spiral, oval, or any variant of the circle. An imaginary line drawn between the two deltas must touch or cross at least one of the recurving ridges within the pattern area.

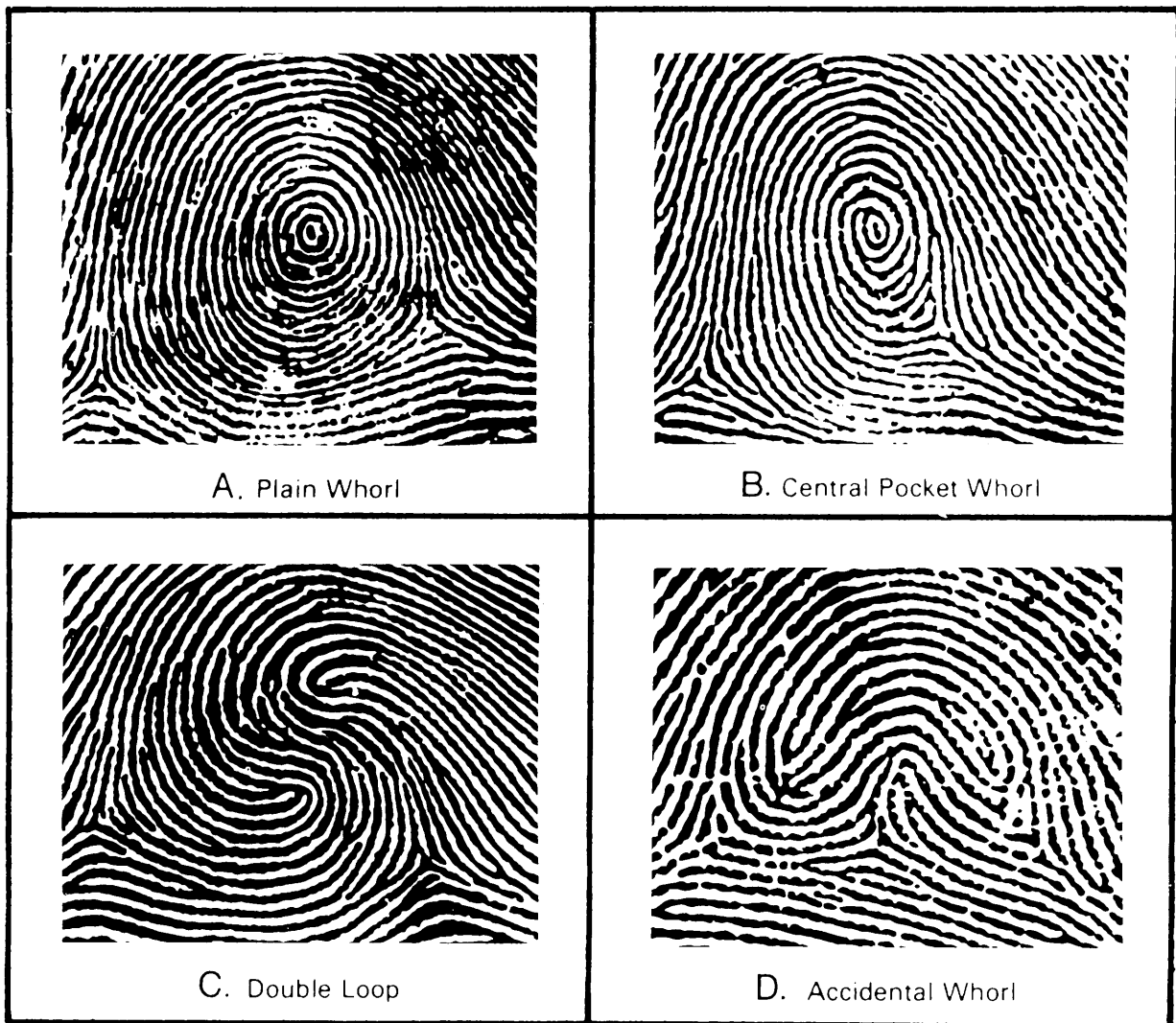

Figure 16-6.-Fingerprint patterns.

The central pocket whorl, figure 16-6, view B, consists of one or more recurving ridges, or an obstruction at right angles to the inner line of flow, with two deltas between which an imaginary line would cut or touch no recurving ridge within the pattern area. The inner line of flow of a central pocket loop is determined by drawing an imaginary line between the inner delta and the center of the innermost recurve or looping ridge.

The double loop, figure 16-6, view C, consists of two separate loop formations, with two separate and distinct sets of shoulders and two deltas.

The accidental whorl, figure 16-6, view D, is a pattern with two or more deltas, and a combination of two or more different types of patterns exclusive of the plain arch. This classification also includes those exceedingly unusual patterns that may not be placed by definition into any other classes.

Classification and Identification

Classification is simply a method by which a set of fingerprints may be suitably filed and easily retrieved for future use. Many fingerprint cards may have the same classification. Classification and identification are two distinct concepts that have only a casual connection with one another. Few latent prints recovered at crime scenes are classifiable. The majority of latents are partial or fragmentary impressions.

Identification is qualitative and quantitative comparison of one friction ridge print with another. Identification may be effected with impressions of any area of friction skin and is established by the individual ridge characteristics and their relationship to one another.

Frequently, prints may appear similar, but upon examination prove to have been made by different fingers. Many prints may also appear dissimilar because of the pressure or the curvature of the receiving surface, but examination by a qualified fingerprint examiner may prove they were made by the same finger.

Positive identification or elimination of fingerprints should always be made by a trained and qualified fingerprint examiner.

Maintenance of Fingerprint Records

Because fingerprint records are essential in the identification of personnel, they should be kept safe from compromise or accidental destruction.

In the notes of the investigation the investigator records all data concerning fingerprints. This assists him or her in the conduct of the investigation and in later preparation for testimony in court, should that become necessary.

The location at which fingerprints were found at a crime scene are cross-referenced to the crime scene sketch as well as to the investigator's notes.

A chain of custody on all latent fingerprint evidence is maintained at the appropriate office.

When taking inked impressions, the investigator taking the impressions must sign the card or paper for identification purposes. This signature is important in legal proceedings. It is neither necessary nor desirable to advise persons of their legal rights solely for the purpose of taking their fingerprints. Fingerprints are never given, they are taken for the purpose of identification.

CASTS AND MOLDS

LEARNING OBJECTIVES: Define the terms used when referring to casts and molds, and list the materials used in making casts and molds. Explain how impressions found at a crime scene are protected and preserved. Describe the basic methods of preserving impressions through the use of casts and molds. Explain how casts and molds are made in special situations with materials other than plaster of Paris. Describe how casts and molds are marked for identification, and how they are packaged for shipment to a crime lab.

Casts made of impressions found at a crime scene may provide a positive link that a certain person or item was at that particular location.

Casting and molding is the process used to make reproductions of delicate impressions found at a crime scene, such as footprints, tire prints or tool mark impressions, which may have evidentiary value. The process is also used to make reproductions of impressions found on bulky objects that cannot be sent to the crime lab.

The following terms are used when referring to casts and molds:

Cast— a positive impression made from a mold.

Mold— a negative impression. Details appear reversed when viewing the object and the mold together.

Impression— any indentation from which a cast is made.

Object— anything making an impression.

The following materials are used in the basic method of making casts and molds:

- Plaster gypsum, sculptor's casting grade, or dental compound.
- Rubber bowls. Enamelware is suitable but more difficult to clean.
- Spatula, tapered steel blade, 14-inch.
- Lacquer, colorless or colored.
- Lubricating oil, general-purpose.
- Shellac.
- Syringe, glass bulb, 4-ounce. A baster of either glass or plastic is available in most exchanges and is a suitable substitute.
- Talcum powder.
- Commercial casting and molding compounds.
- Tape, textile cotton, 2-inch, single plain weave, white.
- Ruler. A paper evidence ruler upon which identifying data may be written is recommended.

Reinforcing materials may be made of any readily available material, such as fine-mesh chicken wire, wire screen, grass, gauze, coat hangers cut to desired length, twigs, or other small pieces of wood.

An earthen dam maybe built to form a frame around footprints, or tire prints. Linoleum, lead strips, metal venetian blind slats, or wood specially cut to form a rectangular frame may also be used.

RECORDING IMPRESSIONS

When an impression is found at a crime scene, the first necessary action is to protect it from destruction regardless of where it is found. This may include covering it with an object such as a trash can lid or cardboard box if it is small, or roping it off and posting guards if it is a large area.

Photographing

The next action is to photograph the impression. First, an area photograph should be taken to show the impression's location in relation to other objects.

Next, a closeup photograph of the impression should be made. The camera should be placed so that the plane of the film is parallel to the ground. A flash should be used at all times. It should be held close to the impression at an angle since the oblique light will reveal more details. A closeup photograph should be taken with a ruler alongside the impression so the proper scale can be determined.

Identifying data should be written on a paper rule or other piece of paper and placed in the photograph also. It should include the date, case number (if known), your name, exhibit number (if known), type of film used and camera setting (F stop).

Sketching

The location of the impression should be included in the crime scene sketch, with appropriate measurements. Any distinctive characteristics such as trademarks, nail holes, cuts, scars, or other imperfections should also be drawn in the sketch. Include measurements and other descriptive data in your notes. After this procedure is followed make a cast of the impression.

CASTING

If an impression is found indoors in dust, or if it is made only from dirt adhering to the object, no preparation may be required.

An impression found outdoors should be examined to determine if any loose particles have been blown or otherwise introduced into it. Any such particles should be carefully removed. A syringe maybe used to gently blow dust that may have gathered—a pair of tweezers to lift out small stones—or a pocket knife to flick out such debris. Care should be taken to avoid destroying portions of the impression.

The syringe can also be used to good advantage to withdraw any water accumulated in the impression, or it can be drawn off by cutting a small channel at one side of the impression to allow drainage.

Plaster of Paris Casts

Plaster of Paris is especially suitable for taking impressions of foot and tire prints or other marks (in dirt mud, sand, or snow) that do not require microscopic detail accuracy. Where such microscopic detail is required, a casting medium other than plaster should be selected.

Preliminary steps. You should make a practice cast of your own shoe print before attempting to make the cast that may eventually be used as evidence. In sandy and loamy soils the particles frequently lack cohesion, and the print is therefore fragile.

Strengthen the impression to support the weight of the casting material and to prevent the destruction of fine detail. This is best accomplished by spraying the impression with a plastic spray or shellac. Hair net spray makes a good substitute if the others are not immediately available. Application of a direct spray may cause destruction of details. Direct the spray against a baffle made of cardboard or some other material to cause a fine mist to settle gently onto the print.

The number of coats to be given can best be determined by an examination of the test print. Usually from 3 to 10 coats in sandy soils are sufficient.

Shellacs, varnishes, and plastics are used only to solidify the print and are not always essential to the casting process.

When the plastic spray has completely dried, a thin mist of light oil allowed to settle on the print will make it easier to remove the completed cast from its surroundings.

If the print is in a good solid earthy material, no further preparation is necessary.

A retaining wall should be placed around the print to confine the plaster to a convenient area and to allow the cast to be built up to the desired thickness. The retaining wall may be constructed of any available material, including earth, to build a damlike structure.

If strips of material are assembled to be used as a kit, and it is intended that they be used over again, give them a light coat of oil before they are used. That will permit them to be easily removed from the cast.

Mixing the plaster. The plaster of Paris mixture may be prepared by one of two methods, both of which require the sifting of the plaster into water. Never add the water to the plaster; add the plaster to the water.

One method is to sift the dry plaster slowly into the water while constantly stirring the mixture. In the second method, the plaster is added to the water by sifting the plaster around the edges of the container. Plaster is added until it begins to rise to the surface of the water. When cracks, similar to those seen in dried mud, appear, no more plaster should be added.

Mix by stirring beneath the surface to a thick creamy consistency. If lumps appear, they should be removed.

It is advantageous first to mix a thin mixture to place in the impression to record the finest of details. The thin mixture is able to flow freely into the impression. Follow this with a thicker mixture. Do not make the thin mixture too thin, as it may wash away details. Experimentation will best indicate just the right proportions.

If a mixture is made too thick, it must be discarded and a new batch mixed. The mixture is ready to pour when it has reached the consistency of thick cream.

Pouring and strengthening the cast. When pouring the plaster into the impression, it should be poured from a low level and the force of the plaster falling into the impression should be broken by letting it drop first onto a spatula or the hand.

Move the ladle or stick in a circular motion to cover the entire area of depression. Put the plaster into the impression at a place where very little, if any, detail exists. These precautions should be taken to prevent destruction of important details.

After a layer of plaster about one-half to three-fourths inch has been poured, the reinforcing material should be added. If sticks or wire are used, take care to prevent the ends from protruding through the bottom of the cast. If dried twigs or wood are used, they should first be soaked in water, as they will absorb water from the cast, making it more fragile.

Twigs, sticks, and pieces of wire should be laid at random in the cast and not laid parallel. If the reinforcing material is laid parallel in a single direction, the cast may fracture in the same place in which the pieces of reinforcing material have been laid. Wire mesh does not present this problem.

After the reinforcing material has been introduced into the cast, the rest of the plaster can be added until the desired thickness of the finished cast has been reached.

Additives. While a thin mixture of plaster of Paris will record more fine detail than a thick mixture, it will require a much longer setting time. One-half teaspoon

of salt added to each pint of water used in fixing the plaster will hasten setting. The more salt, the faster the setting. Sugar added to the water will retard the setting. A saturated solution of borax, 1 part of borax to 10 parts water used will retard the setting from 15 to 30 minutes. It also makes the impression harder and sharper. Substances used to hasten or retard the setting should be added to the water before the plaster is added.

Completing the Cast. Before the cast is completely set, it should be properly marked for identification. The identifying data can be scratched into the surface of the cast with any suitable instrument.

As a minimum, the data should contain the case number, date, your initials, and any such other information deemed necessary. An arrow indicating the direction of north will enable you to locate the exact position of the cast in relationship to other evidence found at the crime scene.

When several casts are made at the same location number them consecutively. The number of each cast should be entered in your notebook, along with data describing the original location. To assist the laboratory examiners with their examinations, a number of casts may be taken of different shoe and tire impressions found at the crime scene. Often, a print made by a particular shoe will clearly indicate details and characteristics that are not found in a second print made by the same shoe.

Removing the cast. After the cast has completely hardened, it may be removed for further processing. Plaster usually hardens within 20 to 30 minutes after preparation. During the process of setting, the plaster becomes warm. When it starts to cool, the plaster has hardened sufficiently for removal.

Care should be exercised in its removal. Even though it has been reinforced, plaster is still fragile.

After the plaster has been removed, any excess dirt may be dislodged by washing the cast gently in a pan of water, with a hose, or under a faucet. If a hose is used to wash it off, remove the nozzle since water under pressure may round off edges or obliterate small details. The use of a brush or water under pressure should be avoided to prevent possible damage to details in the face of the cast.

If portions of the surrounding soil are to be collected for submission to the laboratory for petrographic comparison with the soil sticking to the shoes or clothing of a suspect, it maybe appropriate to send the cast to the laboratory without washing. This will provide the

laboratory with samples of the soil directly under the shoes of the suspect at the time of the imprint, and may be of aid to the examiners in making a comparison of the soils.

Special Situations

Special techniques must be used in casting under water or in snow. Let's take a look at these.

Casting under water. It maybe necessary to cast a footprint or tire print that is entirely underwater, where the location and amount of water present precludes draining or removal of the water. A section of stovepipe may be used to direct dry plaster to the print location and prevent waste of the plaster. The dry plaster should be sifted into the stovepipe and directed into the impression. This method can be used even in fairly deep water. Three to 4 parts of salt maybe added to 10 to 12 parts of plaster of Paris to hasten the setting time.

Casting in snow. The temperature, depth, and adhesive quality of the snow, and the condition of the ground surface, are all important factors. Plaster of Paris emits some heat as it hardens and has a tendency to melt the snow, destroy the print and impair details of the cast. You should make trial casts in the snow away from the impression to determine which of the several techniques are best in the situation with which you are faced.

The imprint may be strengthened by spraying with plastic spray. Then a thin layer of talcum powder should be dusted into the imprint with a syringe to act as insulation against the heat. The impression should again be sprayed with the plastic. Several coats of spray may be necessary to suitably fix the impression.

A retaining wall is especially necessary here to prevent spread of the plaster to areas not insulated. In uninsulated areas, the heat of the setting plaster might melt the snow and water might run under the prepared imprint, further contributing to its possible destruction.

Other Casting Materials and Possible Uses

In addition to plaster, other casting materials may be used to obtain prints. Let's look at some of these and their possible uses.

Dental stone. Use of dental stone allows for a cast of only one layer approximately one-quarter inch thick. It develops into a very durable and a lighter cast than plaster of Paris, and reinforcing materials are not necessary. It is highly recommended for use and is much more economical and convenient.

Silicone rubber. Silicone rubber, although more expensive than plaster of Paris, offers some distinct advantages. Silicone rubber's advantages are that casts can be made quickly, water or heat is not needed, and castings are rubbery, eliminating the problem of breakage during handling or shipping. The rubber freezes at extremely low temperatures, making it extremely useful in casting tracks or prints in the snow.

Silicone rubber, a fast cure, room temperature vulcanizing rubber, requires no heat and sets up into a solid rubbery mass. The catalyst (a substance that causes or accelerates a chemical reaction) is supplied in a small tube with the silicone rubber package. The catalyst should be thoroughly mixed with the liquid rubber just before using. About one-half teaspoon of catalyst to a pound of the rubber is normal.

Curing time of the rubber can be varied by altering the amount of catalyst added. A table is supplied with the material. A curing time of 5 to 10 minutes for prints in dust is recommended.

Care must be taken when mixing to preclude the formation of air bubbles as they may obscure details in the cast. When catalyzed, the rubber will remain workable for about 5 minutes at 77°F, after which it will set. Lower temperatures will lengthen the setting time.

Suggested uses of silicone rubber include foot and tire prints, dust prints, tool and jimmy marks, casting of parts of the human body, and fingerprints. Silicone rubber is not recommended for surfaces bearing natural patterns such as leather or fabrics as the detail of the print is obscured by the detail of the natural surface.

Epoxy casting resin maybe used to make a positive from the silicone rubber impression.

Silicone rubber can be used to obtain fingerprint impressions found in putty and in caulking around window panes when they cannot be removed and forwarded to a laboratory.

There are other casting materials and uses available that are not covered here but are found in Army field manual, FM-19-20, *Law Enforcement Investigations*.

Special Techniques

Obtaining footprints, tool marks, and tire impressions require that special technique be used.

Footprints. When a search indoors is to be made for footprints, it is advisable first to darken the room. Use a flashlight, with the beam aimed low, to search

floors, windowsills, and furniture. Oblique lighting will often show up traces not visible with ordinary or direct light.

Footprints on carpets should not be overlooked, as appropriate photographic techniques may produce valuable evidence photographs. Excellent results have been obtained by using a high-contrast film and a high-contrast paper for the print.

Footprints on solid surfaces made by dust particles adhering to a shoe can be lifted by the use of large sheets of ordinary fingerprint-lifting tape.

Tool marks. Tool marks on metal surfaces, such as hammer blows on a safe, are usually extremely faint and the details microscopic. The wax portion of the "Posmouflage" material is excellent for use in these cases. Other marks having deeper indentations may be cast using any of the materials previously mentioned. These types of impressions, including "jimmy" marks on doors and windowsills, are not easily destroyed so other substances may also be used.

Tool marks may be destroyed or changed if tampered with by an untrained or unskilled investigator. Original evidence is more useful for scientific examination and evaluation and is less subject to attack in court than reproductions. You may often be unable to make photographs and casts that represent the evidence sufficiently for identification purposes at a laboratory.

Tire impressions. The circumference of a tire is 5 to 8 feet. The probability of identifying or matching a tire track with a particular tire increases with the length of the cast or casts obtained. Ideally, consecutive tire casts should be made equaling the circumference of the tire involved.

Casts should be made of each individual tire track if more than one track is found. Testimony that the combination of the designs taken from a set of four tire impressions found at the crime scene corresponds to the designs and the wheel positions of the four tires on the suspect's automobile is of obvious value.

Each cast and tire submitted should be fully identified as to the wheel position. (See fig. 16-7.) Sketches, photographs, and other recorded entries should likewise identify wheel position.

MOLDING

It may be desirable to produce a mold from a cast that had been made previously. It might be advantageous to provide several investigators with

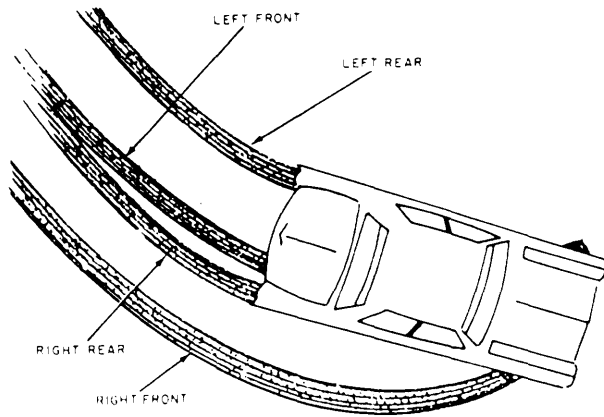

Figure 16-7.-Identifying wheel positions in curved tire tracks.

copies of the cast so they can search independently for the shoe that made the original impression. Once a mold is made of the cast, as many copies as needed can be reproduced. Casts made with agar moulage compositions require that a mold be made shortly after the cast to meet evidentiary requirements.

Plaster of Paris

To make a plaster of Paris mold from a plaster of Paris cast, the cast should first be given a thin coating of light oil, otherwise it will be most difficult, if not impossible, to separate the cast from the mold. With this precaution having been taken, the procedure for producing the mold is almost identical to that used when making the cast.

Plaster of Paris is mixed and poured into a container or onto a flat surface with the area contained by framing material. A rubber photochemical tray of appropriate size makes a good container. The cast, after being coated with oil, is placed into the plaster mixture to an appropriate depth. When the plaster mixture has set, the cast may be removed, leaving a mold that maybe used for making other casts.

If duplicate casts are to be made of plaster of Paris, the mold must be coated with oil or the same problem of separating the cast from the mold will again present itself.

Positive Moulage-Agar Compositions

Positive moulage material, a wax, may be melted over a slow fire in any pan from which it can be poured.

If the cast is hollow, the melted moulage should be poured in, allowed to stand 2 or 3 minutes, and then

poured out. This procedure is then repeated as necessary, allowing a slow buildup of wax to the required thickness.

The moulage may be brushed or poured into other-than-hollow negative casts. Since the moulage will not adhere to anything, it may be used for making molds from plaster casts. No oiling of the cast is necessary. The cast can be appropriately framed and the material brushed onto the cast, or it may be applied with a spatula.

The mold should be reinforced with wire mesh or cloth. Bandages make excellent reinforcing material.

LABORATORY EXAMINATION

A plaster of Paris cast, even with reinforcing, is fragile evidence and must be handled carefully. The cast should be wrapped in soft paper or cotton to avoid abrasion and possible destruction of fine identification points. It should then be well wrapped in strong wrapping paper and secured. The cast may then be placed in a box, cushioned on all sides by excelsior or other shock-absorbing material.

Wax and modeling clay casts, while not as fragile as plaster, present other problems, such as being easily deformed by pressure. These types of casts must be protected from pressure as well as abrasive action. Photographs of the impressions from which the casts were taken should also be forwarded with the casts to a laboratory to aid the examiner in the analysis.

Articles such as shoes or tools, to be shipped to the laboratory for comparison purposes, should be boxed and shipped separately. They should be protected from the accidental addition of marks which might invalidate them as evidence. The chain of custody requirements are equally applicable to this type of evidentiary material as to any other.

The examination of cast and mold evidence usually is done in the fingerprint division of a laboratory. There are two types of characteristic—class and individual. Class characteristics are those marks and lettering that result from the manufacturing process. Individual characteristics are those marks peculiar to certain objects, such as cuts, tears and uneven wear which result from its daily use.

These characteristics allow the examiner to establish positive or negative identifications with a particular object. Remember that this type of evidence might also be used to eliminate suspects. The importance of this very valuable evidence should not be

minimized, and every effort should be made to secure casts of impressions found at the crime scene.

GLASS FRACTURES

LEARNING OBJECTIVES: Describe how glass or glass fragments may provide information in the investigation of offenses. Explain the nature and properties of glass and how glass should be collected and handled. Explain how the investigator should examine glass fragments and fractures. Describe the process of laboratory examination of glass, the techniques used, and the possible outcomes of laboratory examination of glass.

Glass, or glass fragments, will frequently be important factors in the investigation of offenses such as burglary, housebreaking, fleeing the scene of vehicle accidents, and others. The ultimate value of such material, either as evidence in itself or in the investigative leads which may be obtained from it, depends on your knowledge and training in the nature of glass, proper procedures of collection, preservation, and examination, and what you and the scientific laboratory technician can learn from it.

Glass fractures and glass fragments can provide information from which the following types of determinations may be possible:

- That a fragment of glass did or did not originate from a particular glass object that has been broken (such as a fragment of headlight lens found at the scene of a vehicle accident did or did not originate from a broken headlight of a suspect vehicle).
- That a fragment of glass originated from a particular kind of glass object, such as a headlight lens, spectacle lens, or windowpane.
- The origin and direction of a fracture; that is, what caused it and the direction from which the causative force came.
- In the event of multiple fractures, including bullet holes, the order in which the fractures occurred.
- The angle from which a bullet struck a glass object.
- That a particular glass object, such as a bottle or jar, contained an inflammable or explosive substance.

NATURE OF GLASS

Before discussing specific matters related to glass as evidence, a general understanding of the nature and properties of glass is required.

Glass is normally a fused mixture of silica usually in the form of natural sand and two or more alkaline bases such as soda, lime, or potash. It also contains quantities of various other elements and metals, present either as incidental impurities in the basic constituents or added to them for color, degree of hardness, heat resistance, and other specific purposes.

These constituents are melted in a melting pot under very high temperature, and the molten mass is then either rolled, blown, or molded into desired sizes and shapes. It may later be polished, ground, or cut for useful or decorative purposes, or it may be combined with other materials. For example, sheet vinyl plastic is fused between sheets of plain glass to form safety glass.

PROPERTIES OF GLASS

The value of glass to you, either as evidence or in the development of investigative leads, lies mainly in its physical properties. These properties make it possible to determine that glass fragments did or did not originate from the same source, or to determine the manner in which a piece of glass was broken.

Differences in the amounts of mineral composition of ingredients used in one batch of molten glass from those used in another will produce variations that can be detected and proved under laboratory procedures if a continuous batch process was not used.

Other properties of glass provide for determinations that may be made by you or a laboratory examiner. These properties include the fact that glass seldom breaks squarely across but leaves convex/concave edges, or stress lines, on the fractured edges; that it bends and stretches before breaking; and that breaks produce both radial (primary) and concentric (secondary) fractures. (See fig. 16-8).

COLLECTING AND HANDLING

The procedures used in the search for and collection of glass and glass fragments are, in general, the same as those used for other types of evidence. Differences are due to the nature of glass itself and to the investigative and evidentiary findings to be sought from it.

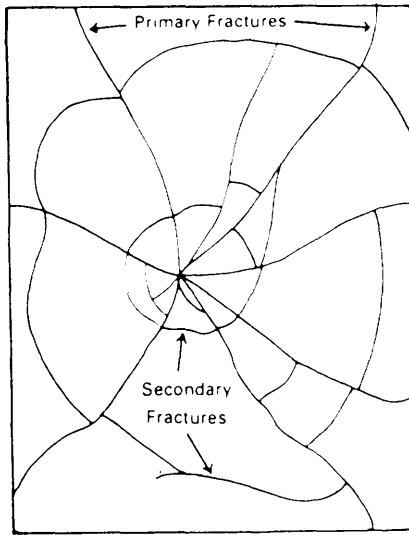

Figure 16-8.-Radial and concentric fractures.

Records

As with other types of evidence, glass and glass fragments must be photographed and their locations noted on the crime scene sketch before they are touched or moved. Pertinent data must be recorded in your notes concerning the glass and any obvious, suspected, or hypothetical relation it has to the incident under investigation.

Collection

In collecting glass or glass fragments, carefully avoid smudging any fingerprints or disturbing any other substance such as dust or dirt, bloodstains, or other foreign matter which may be on the glass, since any or all of these may provide investigative leads or be evidence in themselves.

Rubber or fabric gloves should be worn, and rubber-tipped tweezers or a similar device should be used for handling small fragments so as not to scratch the glass. Metal tweezers with adhesive tape placed over the inner surface of the points make a good field expedient.

Glass should be picked up by the edges, avoiding the plane surface as much as possible. All available fragments should be collected to provide as complete a reassembly as possible. Even particles too small to permit matching or reconstruction should be collected and preserved, since they can be analyzed in a laboratory for their physical properties.

In cases where the glass has been broken out of a window, door, or similar frame, and pieces remain therein, the frame should be removed and kept intact, if this is practicable. (It may be necessary to provide interim protection for the premises.) This procedure will also make reassembly of the broken pieces easier.

If removal of the article is not practicable, the pieces remaining in the frame should be carefully marked (inside and outside surfaces must be designated) and removed to avoid further damage to the glass or disturbance of any depositor substance thereon. If the frame is not removed, samples of the wood, paint, putty, and any other materials should be collected from it.

Broken glass may provide a valuable clue in the identification of a suspect.

Frequently, in the commission of an offense such as burglary, the perpetrator will break a window or other glass object. Particles or fragments of the glass may lodge in, or adhere to, his or her clothing or fall into a pocket or trouser cuff. Collection and laboratory analysis of such fragments for comparison with glass found on the scene is a worthwhile effort. The soles and the sewn edges of the shoes should not be overlooked in the search for this type of evidence.

This type of thorough search may also be productive in the investigation of a fleeing-the-scene vehicle accident where glass was broken. Fragments or particles of glass maybe found adhering to, or imbedded in, the tires of the suspect vehicle. These should also be submitted for laboratory analysis.

Marking

Glass fragments of sufficient size are marked with a diamond point or carborundum pencil, a piece of properly marked adhesive tape, or a grease pencil. Markings are placed in an area that is of value as evidence. Markings should include your initials, the date, and time.

To aid in reassembly of the fragments and in reconstruction of the incident, markings are placed on the side which was up (or inside the building or room if taken from a window frame or door) when found, and include a sequence number which, when keyed with your notes, photographs, and sketches, serves to identify the location where found. Fragments too small to permit such markings are placed in suitable containers, and both the container and lid marked.

Preservation

Glass or glass fragments should be wrapped in soft paper, cotton, or similar material which will prevent breakage, in a manner which will avoid damage to fingerprints or other substance to be examined by the laboratory or preserved as evidence. The wrapped glass is placed in suitable containers, properly fastened so that it will not shift. Wrappings and containers should be marked "Fragile."

Property tags and property receipts should be prepared by you, and the property should be released to the designated custodian at the earliest possible time. The letter of transmittal and request for laboratory examination should also be prepared by you.

INVESTIGATOR EXAMINATION

You should evaluate glass fragments and fractures as you do other items of evidence, considering their importance and their relationship to all other evidence. This evaluation begins, of course, in the initial stages and continues until the investigation is completed or discontinued.

In the evaluation process, the meaning and value of certain materials found on the scene are not always easy to determine in the initial stages. This raises the question as to whether you should collect and preserve such materials. The safest decision is to do so. If you do not, it is likely that the broken glass will be quickly discarded as trash, and neither you nor a laboratory will have an opportunity to evaluate or examine it. Material that proves valueless can be disposed of or discarded at a later time.

In your evaluation, you should also consider the need or desirability of scientific laboratory analysis. Should you decide upon such action, it is usually best to request it as early as possible. In some instances, speed may be essential, as in cases involving fragments of glass containers which are suspected of having contained inflammables or explosives so odors or residue may be retained, or to provide further investigative leads.

General Examination

Examination of fractured glass found at the scene of a crime may reveal the direction from which the blow was struck.

When broken glass is reconstructed, some of the fractures (the primaries) in the glass will resemble the

spokes of a wheel in that the fractures will radiate outward from the point of impact. These spokelike fractures, called radial fractures, originate on the surface opposite to that on which the fracturing blow or pressure was applied. They tend to lengthen after a period of time because of internal stresses setup by the original shock. The original radial fracture will appear as a wavy line. Extensions to the original fracture will run in a straight line. Temperature changes cause extensions to develop more rapidly.

Another force working in the opposite direction causes the glass to break in secondary fractures, called concentric fractures, which form a series of broken circles, or arcs, around the point of impact. These fractures are made in the opposite manner from radial fractures, the glass bending on the opposite side and then stretching and breaking on the side from which the original blow was applied. They extend from one radial fracture to another.

Edges of broken pieces of glass bear a number of curved lines, called stress lines. (See fig. 16-9.) These stress lines are almost parallel to one side of the glass and perpendicular to the other. Stress lines are usually visible to the naked eye. If the lines are difficult to detect, turn the glass at various angles to the light so that the reflection will reveal them. Stress lines indicate the increase in stress setup in the glass until it breaks, and are always perpendicular to the side that broke first.

In radial fractures, the stress lines are perpendicular (at right angles) to the side opposite from which the blow

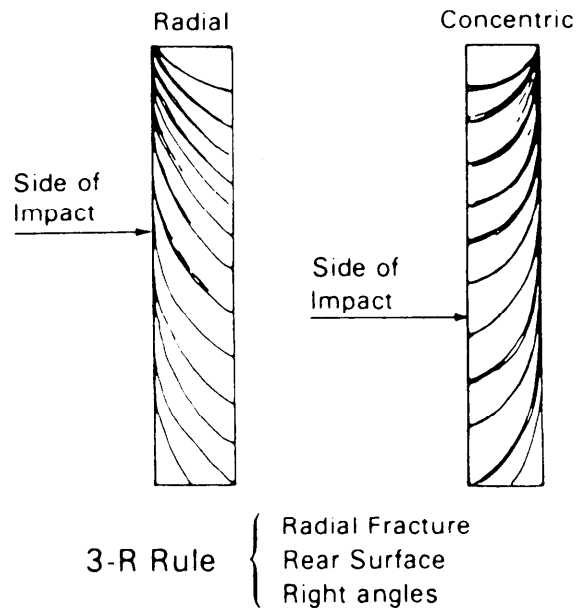

Figure 16-9.—Stress line.

was struck. In concentric fractures, the stress lines are perpendicular to the side on which the blow was struck.

From these facts the 3-R rule was developed-in **RADIAL** fractures, the stress lines are at **RIGHT** angles to the **REAR** surface.

Accordingly, if the examiner is sure of the type of fracture being examined it can be determined from which direction the blow was struck. The direction of the blow cannot usually be determined by examining a single piece of broken glass. When it is necessary to prove the manner in which a pane of glass broke, sufficient glass fractures must be assembled to determine which are the radial edges.

Determination of the outside and inside of the glass may be aided by examining the surface of the glass, noting the amount of dirt on the surface, putty marks, and other indications that may help to replace the pane in its original form. After sufficient pieces are put back in place to enable an identification of radial and concentric fractures, the stress lines on the edges can be examined to determine the direction of the blow.

Glass and glass fragments found at the scene of a crime involving explosives or inflammables may provide you with valuable information.

Door or windowpanes broken inwardly may suggest a means of entry, or they may have burst from exposure to heat. Such panes broken outwardly may indicate the direction, force, and limits of an explosion or blast, and may indicate the point of origin.

Glass fragments, especially of bottles or jars, may bear odors or chemical traces of explosive or inflammable agents that you may readily identify or may be subjected to laboratory analysis for identification.

Safety Glass

Safety glass, commonly used in automobiles, consists of a transparent binding agent, such as a sheet of vinyl plastic sandwiched between two sheets or ordinary glass. The binding agent prevents shattering of the ordinary glass when it is struck.

Due to the structure of safety glass, cracking is frequently incomplete, in that neither the radial nor the concentric cracks penetrate completely from one side to the other.

In such cases, the side of impact maybe determined. If the concentric cracks appear only on one side, and no radial cracks are found on that side, that is obviously the side of impact. If only radial, and no concentric cracks

are found on one side, this is the side away from the impact.

Determination can usually be made by sliding the fingernail, or a sharp-pointed instrument, along the glass surface across the apparent cracks.

Another test for side of impact is based on the property of safety glass that causes it to bend and remain somewhat bent, instead of shattering when struck. Since the bending will result in a concave surface on the impact side and a convex surface on the opposite side, determination may be made by placing a ruler, level, or other straightedge on the plane surface and observing the result.

Paint Spots on Glass

Glass on automobiles frequently bears traces of the paint used on the automobile body. Such traces can be of value particularly in cases of fleeing-the-scene accidents, since they may indicate the color of the vehicle. While these traces may be plainly visible to you, and identifiable at least as to color, better results can be obtained in a laboratory.

It is of primary importance that you examine glass in such cases very carefully, as not to disturb any specks, flakes, chips of paint, or other foreign matter on the glass, and that you make specific reference to them in your request for laboratory examination.

Fractures Made With a Blunt Instrument or Object

Examination of glass fractures caused by the impact of a blunt instrument or object will reveal a pattern of radial and concentric fractures.

The impact side can be determined by careful examination of the stress lines on the edges of both the radial and concentric fractures.

As an initial step, at least partial reconstruction of the object should be made, so radial and concentric fractures can be positively determined.

On radial fracture lines, the portions of the stress lines on the rear side (the side opposite to the side of impact) are well developed and distinctly individual; whereas those on the front, or impact side, are much less so, tending to run together and lose their individuality. The 3-R rule applies.

On concentric fracture lines, the opposite condition will be found, with the well-developed and individually distinct portions of the fracture lines appearing on the front, or impact side.

This difference is a result of the glass bending away from the side of impact and the first (radial) fracture occurring on the rear side after the limit of stretching elasticity has been reached. This action produces the distinct stress lines on the stretching (rear) edge of the radial fractures. At the same time, the ensuing grinding action that takes place on the front side causes some chipping and flaking of the edge and a partial wiping out of the stress lines. (See fig. 16-10.)

Fractures Caused by Heat

Fractures caused by excessive exposure to heat can be distinguished from those caused by impact since those due to heat do not show a regular pattern of radial and concentric lines. Heat fractures are characteristically wave-shaped.

Heat fractures will also show little, if any, curve patterns (stress lines) along the edges. Expansion of the glass (stretching action) occurs first on the side exposed

to the heat, and glass splinters will usually fall toward that side. Reconstruction of a glass object fractured by heat will disclose the wave-shaped fracture pattern. (see fig. 16-11.)

If the stress lines are smooth, or almost so, and no point of impact or penetration is present, these factors, together with other considerations such as the circumstances under which the fragments were found and their location, may indicate that fracture was due to excessive heat.

Reconstruction of Fractured Glass

In reconstruction of a glass object that has been fractured, one of several methods may be used, dependent upon the size and shape of the object. Reconstruction should not, however, be made on any fixed or permanent basis until all examinations have been completed. Neither should pieces or fragments be sent to a laboratory in a reconstructed form, due to possible damage in handling or transit.

In its simplest form, reconstructing a piece of fractured glass, such as a windowpane, is accomplished in much the same manner in which a jigsaw puzzle is reconstructed. The sizes of the fragments, their shapes, and particularly the fractured edges, are considered in their relation to each other, and moved around until fitting, or matching edges are found.

It will not always be possible to find exact and complete edges for all pieces, since some small fragments, chips, or flakes will either have been lost or will be too small to use in the reconstruction.

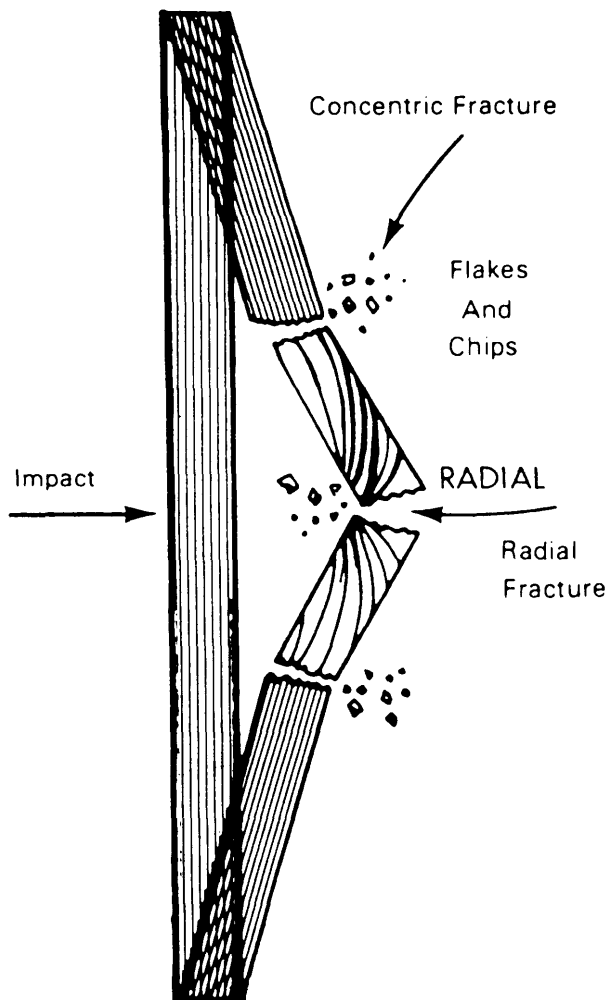

Figure 16-10.—Chipping and flaking action due to grinding and fractured edges.

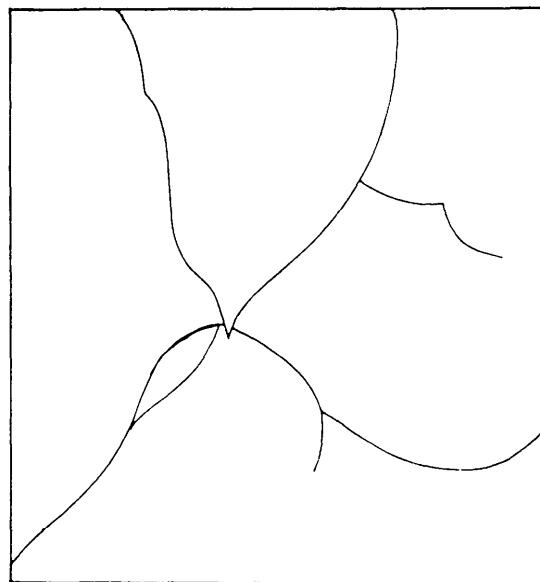

Figure 16-11.—Fractures due to heat.

For reconstruction of a flat piece such as a windowpane, lay the pieces on a sheet of cardboard or paper somewhat larger than the known or estimated size of the original piece. Perimeter edges can usually be identified by their straight lines and by the remains of putty, paint, or the scratches or marks left by nails or glazier's points. It is generally easier to place all of these pieces first, and to reconstruct from the outside in, than to work out from the inside.

Extreme care must be taken not to rub the fractured edges against one another, since this may cause further flaking or fracturing and destroy portions of the stress line marking. A recommended method is to keep the edges a pencil point's width apart. When all (or as many as possible) pieces are in place, the outlines may then be traced on the paper and properly annotated according to your markings on the pieces, for future reference and use.

If a permanent reconstruction is later desired, the pieces may be secured on a suitable base (plywood or heavy cardboard) with plastic tape or glue.

Reconstruction of a curved or irregular-shaped piece, such as a bottle or jar, presents more initial difficulties since it requires a determination, or approximation, of both the size and the shape of the object. These difficulties are generally counterbalanced, however, because such pieces (such as automobile headlight lenses) frequently have patterns cast or cut into them that allow for comparisons and matching that are not as readily possible with flat or smooth glass surfaces.

In many cases, the pattern may be matched independently of the fractured edges, although the exact matching of the edges remains the most conclusive evidence of common source.

In preparing the reconstruction of a headlight lens, for example, the perimeter circumference size and the curvature of the spherical surface must first be determined. If sufficient pieces are available and matching edges or patterns can be found, the problem is simplified. The same is true if sufficient markings are available to identify the object as to make, type, size, and so forth and permit procurement of a duplicate.

A satisfactory method is to form a cast of linseed oil putty or similar material that will retain its elasticity in the size and shape of the inside surface. (If the lens can be identified and a duplicate obtained, a plaster cast may be made from the duplicate and the fractured pieces can be mounted on it, held in place by plastic tape.) Pieces and fragments, properly marked, can then be matched

by their edges and pattern markings, placed on the cast, and pressed in only sufficiently to hold them in place.

If sufficient pieces are not available to identify the object and secure a duplicate, or to assemble enough pieces to indicate the circumference and spherical surface, a piece with sufficient arcs of the circumference and sphere can be measured to a rough, but sufficiently accurate, degree to permit formation of the putty cast. A spherometer, if one is available, or a Geneva gage, obtainable from an optician, can be used to determine the curvature of the spherical surface and the circumference of the lens.

Keep in mind that these are only rough approximations, and that lenses are made not only in round, but also in oval and other shapes, and that the spherical surfaces are not always completely regular in contour.

If neither the spherometer nor the Geneva gage is available, an approximation of measurements may be obtained by geometrical projection using the arcs of the circumference and sphere of the available fragments. By tracing the arc of an available fragment on a piece of paper and using standard geometrical construction to approximate the diameter, the circumference can be projected.

LABORATORY EXAMINATION

You may find it advantageous to delay submission to the laboratory of some items, such as pieces of broken headlights found at the scene of a fleeing-the-scene vehicle accident. Temporary retention of such pieces permits visual matching of remaining pieces found on a suspected vehicle, to be later confirmed if possible, by laboratory analysis.

Conversely, early submission for laboratory analysis may facilitate the investigation, as in the case of an accident where no suspect vehicle is promptly located. The laboratory may, if sufficient glass is available, identify the vehicle as to make, model, and year of manufacture, or eliminate from consideration glass from a suspect vehicle, thus narrowing the investigative field. Since glass is not destroyed or appreciably altered in laboratory examination (except in spectrographic examination of small fragments), the evidence pieces are available for later comparison with suspect pieces.

The material contained in the following paragraphs on laboratory methods of analysis is not intended to make you an expert in this field, but only to give you

general working knowledge of various methods of analysis that qualified laboratory technicians can provide to assist you in your investigation.

Glass Fragments

Various glass fragments such as broken headlight lenses, broken bottles, and similar glass materials may furnish important investigative leads when examined by properly trained technicians to determine their composition and possible identity or nonidentity with other fragments. A scientific examination of several particles of glass may disclose identical physical and chemical characteristics, indicating that all particles came from the same piece of glass. It can be determined whether minute particles having the physical appearance of glass are actually particles of glass.

Glass Fractures

Laboratory examination of fractured glass found at the scene of an incident may indicate:

1. Type of glass
2. Manufacturer of the glass
3. Glass did or did not come from a certain place or thing
4. Direction of blow
5. Direction and angle of impact of bullet
6. Sequence of holes

Fluorescence

While it may not produce results as positive as those by other examinations, examination of glass fragments under ultraviolet light may be useful in determining that two pieces of glass could or could not, have originated from the same object.

The fluorescence examination is based on the fact that mineral constituents impart a distinctive type and degree of fluorescence to the glass originating from one molten batch. While the results of ultraviolet comparisons of two or more pieces may not be positive in establishing similarity, they may be positive as to dissimilarity and thus useful in the elimination process.

Since fluorescence examination requires that the glass be absolutely clean to preclude fluorescent reaction from contaminants, wash the glass in acetone or a similar solvent, and in water. Therefore, caution should be taken that this examination is not performed

until after other examinations for fingerprints, surface debris, and so forth have been completed.

Spectrographic Analysis

The constituents of glass, especially the minor or trace constituents such as contaminants and minor elements added for specific purposes, lend themselves readily to spectrographic analysis, which identifies and measures the quantities of these constituents. The presence or absence, and the quantities, of these minor constituents are of more importance in the spectrographic analysis than are the basic constituents that are ordinarily present in such comparatively great quantities that differences in the spectral lines of various fragments are often difficult to detect. The spectrograph, for this reason, is of greatest value in demonstrating major differences between two samples, indicating their nonidentity, rather than in indicating acceptably proven identity.

Spectrographic analysis should not be routinely requested in all cases, since it is not always necessary or useful to the investigation, and since small fragments are destroyed by the analysis. Other examinations should be completed first, and spectrographic analysis requested only if considered necessary.

Refractive Index

Refraction refers to the change of direction of a ray of light in passing through a medium whose density is not uniform, as through a piece of glass that has been ground to specific requirements.

The refractive index can be measured either microscopically or with a refractometer. The latter method, however, requires that the two sides of the sample be parallel.

Another method known as flotation, in which a chemical solution is used with the refractometer, can be used when the specimen does not have parallel sides.

Density

This analysis is based on the relative densities of two or more pieces of glass. Comparison of the densities of a known and an unknown piece of glass may aid in determining if they are similar or dissimilar.

Transmittal to Laboratory

It is your responsibility, under supervision of the evidence custodian, to prepare and ship (or carry) the

evidence to a laboratory. The evidence should be packed to prevent breakage, friction, shifting, or contact with other items, which would result in destruction, loss, or contamination of the evidence.

All available pieces and fragments pertaining to one incident should be submitted at the same time.

To facilitate the work at the laboratory, each piece of evidence should be identified clearly on individually wrapped items. The evidence number shown on individually wrapped items and on the laboratory request may not necessarily be the same as the exhibit number to be listed in the report of investigation.

TRACE EVIDENCE

LEARNING OBJECTIVES: Describe the methods and techniques used in finding and handling trace evidence. Explain how tool marks, serial numbers, laundry and dry-cleaning marks, bloodstains and body fluids, hairs and fibers, fingernail scrapings, and rocks and minerals should be handled as possible trace evidence. Describe the techniques used in the laboratory examination of trace evidence.

The techniques for finding and handling trace evidence during an investigation cover a large area. The following paragraphs do not cover all material items that could be classified as trace evidence, nor do they cover all investigative techniques that may be used for finding and handling such evidence. The points mentioned will alert you to other possibilities and, by association, suggest further development and perfection of investigative skills.

Trace evidence at a crime scene can include obvious items, such as bloodstains, or inconspicuous items, such as dust particles. All are easily overlooked, frequently mishandled, and all too often discarded as useless. Investigation files contain numerous case histories emphasizing the value of properly handling trace evidence in proving a case against a suspect or clearing an innocent person.

Be alert to the consequences of improper handling of trace evidence, particularly since such handling may completely negate the value of otherwise admissible court evidence. For example, if a suspect is returned to the scene of a crime before the scene is completely processed, the suspect could claim that the hairs found there were left during the return visit. The same

assertion may diminish or negate the value of other trace materials found at the scene such as paint chips, fibers, dirt, and so forth.

Thoughtless intermingling of trace evidence found at different parts of the crime scene may also render valuable evidence worthless.

Always observe the cardinal rule for handling physical evidence, particularly trace evidence—avoid contamination.

Trace evidence may either be deposited at a crime scene by the perpetrator or may be carried away. The perpetrator may leave tool marks, bloodstains, hairs, fibers, soil, and similar traces, or may carry away bloodstains, hairs, fibers, glass fragments, soil, safe insulation, and similar traces on his or her person, clothing, or equipment.

You must keep these and other sources of trace evidence in mind and be diligent in your search for them at the scene, on the suspect, or in the area or on equipment used by the suspect. Unnecessary spectators should not be allowed at the crime scene as they will deposit material at the scene and/or destroy what trace evidence is present.

In rare instances, usually because of a lack of sufficient amount of material, the laboratory is unable to render any opinion concerning the evidence. Negative findings of this nature can be avoided if you follow the guidelines set forth concerning the amount of a specific item of evidence to collect.

TOOL MARKS

The credibility and acceptability of tool mark evidence by the courts has long been accepted.

“Courts are no longer skeptical that by the aid of scientific appliances, the identity of a person may be established by fingerprints. There is no difference in principle in the utilization . . . to determine that the tool that made an impression is the same instrument that made another impression. The edges of one blade differs as greatly as the lines of one human hand differs from lines of another....”

The above is an excerpt from the case of State v. Clark, 287 PAC 18 (1930).

Definitions

A tool mark is an impression, cut, scratch, gouge, or abrasion made when a tool is brought into contact with an object. A tool mark may be classified as a negative impression, as an abrasion or friction-type mark or as a combination of the two.

Negative impression is made when a tool is pressed against or into a receiving surface. This type of mark for example, is usually made when a crowbar is used to pry open a door or a window.

An abrasion or friction mark is made when a tool cuts into or slides across a surface. This type of mark may be made by a pair of pliers, a bolt cutter, knife, ax, saw, drill, plane, or a die used in the manufacture of wire.

A combination mark is made, for example, when a crowbar is forcefully inserted into the space between a door and the door facing and pressure is applied to the handle of the tool to force the door open. The forceful insertion of the crowbar produces an abrasion or friction mark and the levering action produces a negative impression.

Basis of Tool Mark Identification

Because no two tools are alike in every detail, they will not leave identical impressions. Tools may have obvious differences in size, width, thickness, or general shape. They also have minute differences that become apparent only when the tools are examined microscopically. These minute differences may be caused by manufacturing, finishing, and grinding; by uneven wear; by unusual use or abuse; by accidents; by sharpening; or by alterations or modifications made by owners or users of the tools.

On the basis of these obvious and minute differences, it may be possible to identify the tool that made a given impression.

Uses of Tool Mark Evidence

Tool mark evidence may be used to do the following:

1. Link a person who uses a given tool with the crime scene, the commission of a crime, or some act material to a crime.

2. Establish whether a given tool or weapon found at a crime scene made a mark that is material to the crime. This knowledge is of value to you, whether or not the owner or possessor of the tool is known, because

it may eliminate the necessity of tracing a tool that, even though found at the crime scene, has no connection with the crime.

3. Establish a connection between similar evidence discovered in a series of crimes.

4. Determine whether a door or window was forced open from the inside or the outside.

5. Compare a tool mark from a crime scene with a tool mark found on the property, equipment, or vehicle of a suspect.

6. Facilitate and narrow the search for a given tool or weapon.

Examination Techniques

You should arrange for guards to be posted to prevent damage to evidence until you have had time to examine the evidence thoroughly. Make sure doors, windows, transoms, and other openings with hinged or sliding doors or covers are not opened, closed or handled in any way likely to destroy or mar minute tool marks or fingerprints.

Carefully examine every door, window, transom, skylight, and other opening that may have been used by a criminal as a means of entry or exit. Tool marks are likely to be discovered at these points, particularly when forcible entry or exit has been made.

Pay particular attention to broken, forced, or cut locks, latches, and bolts, and the immediate area surrounding these fastenings. Systematically search the entire crime scene and its vicinity for the tool that may have been used. Also examine safes, cabinets, desks, chairs, tables, or ladders for marks.

Tool marks are preserved even if no tools are found at the crime scene—the tools that made the marks may be discovered later. Tool marks and tools should be immediately and carefully noted and pertinent information recorded. Include them in any photographs and sketches of the crime scene.

A tool mark should be photographed as soon as possible.

The tool mark should be examined visually to determine its gross appearance. This will provide information concerning the type or shape of the tool you are to look for. The gross appearance of a tool impression may not be complete or well defined. For example, a hammer impression on a steel safe may not include the edges of the hammerhead, so the shape of the head cannot be determined. In this case, all suspect

tools that could have made the mark must be sent to the laboratory for comparison purposes.

If the surface bearing an impression of a tool mark has been painted, a careful examination may reveal that flakes of paint have been removed and maybe adhering to the tool making the impressions. That may enable you to eliminate a number of possible suspect tools. The pattern formed by the removal of the flakes of paint may also be of value. If a tool is found bearing paint similar to that of the painted surface and the flake pattern appears to be identical in formation, the paint pattern formation should be photographed since some of the flakes of paint might be loosened and accidentally removed from the tool while in transit to the laboratory. The accurate matching of the pattern of paint on the tool with the pattern of the impression may be conclusive proof that the tool made the impression.

The tool should never be fitted into the tool mark to see if it could have made the impression. Such a procedure may prevent the admittance in court of any evidence concerning the tool and its marks, or the paint on it and the object.

Processing Evidence

A decision must be made as to whether the tool mark is to be removed for transmittal to the laboratory. The removal of a tool mark for comparison at the laboratory is highly desirable. Wholesale removal of property or integral parts of valuable structures is neither desirable nor necessary. This is a judgment area and your decision should be based on the following factors:

- Importance of the case.
- Importance of the tool mark in comparison with other available evidence.
- Distance of the crime scene from a criminal investigation laboratory.
- Whether the tool-marked object belongs to the U.S. Government.
- Courses of action. You now have three possible courses of action:
 - Remove the original evidence or the desired portion.
 - Cast and/or mold the evidence.
 - Request that an examiner from a criminal investigation laboratory come to the scene and develop the evidence.

In considering these courses of action, you should also weigh the substantiating value of the original evidence.

Original evidence is more useful for scientific examination and evaluation and is less subject to attack in court than reproductions. You may often be unable to make photographs and casts that represent the evidence sufficiently for identification purposes at the laboratory. In fact, some authorities recommend that casting or other methods of taking impressions of a tool mark should be used only as a last resort.

A casting can never be equal to the original impression. That is particularly so with tool marks made in soft materials such as wood, putty, paint, and so on since many of the casting media most suited for these materials will not reproduce the fine details needed for identification. Experiments have shown that scratches in paint caused by minute irregularities in the edge of a tool cannot be reproduced by an impression or a cast. However, if the original mark is compared with one made directly by the tool, the full proof against the criminal may be obtained.

If a tool mark can be removed for transmittal to a laboratory, you should take several precautions. A sufficiently large piece of the object should be removed to prevent damage to the tool mark through splintering, bending, twisting, or abrading. Any tools found at the crime scene should also be transmitted to the laboratory with the items or original evidence.

An item removed as evidence should be clearly marked with the case number, your initials, and the date and time of removal. The evidence should also be marked to show the inside, outside, top and bottom surfaces, and the area bearing the tool mark.

You may remove, for example, such evidence as the marked portion of a door, window sash, windowsill, or doorsill and that portion of the window or door frame adjacent to the marked area; and any window latch, door latch, bolt, hasp, or lock that has been cut, broken, or forced for entry.

If the surface bearing the tool mark is painted, samples of the paint should also be transmitted to the laboratory. In many cases, even though no paint can be seen adhering to the tool, enough minute particles may be recovered from the tool to permit analysis and comparison at a laboratory.

It is sometimes possible to furnish the laboratory examiner information concerning the angle in which the tool was held when it made the mark. If this

determination is possible, information concerning the angle formed by the tool and the surface of the object and the angle of deviation from the longitudinal direction of scrape marks, will materially assist the examiner.

If a tool mark is on metal and cannot be removed, samples of the metal should be obtained and transmitted to a laboratory. Particles of metal may adhere to the tool, in addition to the paint, and may be analyzed and identified by the laboratory examiner.

If cut pieces of wire are to be sent for examination, the suspect end of the wire should be clearly marked. Wire obtained for laboratory examination, should not be cut with the suspect tool.

Stolen articles, such as automobile radios, that cannot be positively identified by the owner can often be identified as being originally mounted in an automobile by matching cut ends of the wire remaining attached to the automobile to those on the radio.

You should carefully photograph a tool mark before it is moved, cast, molded, disturbed, or altered in any way. Photographs provide a permanent record of the evidence in its original state and location, identify original evidence with any casts or molds that may be made, and satisfy legal requirements for records of original evidence.

You should take photographs to show the tool marks and enough of the surface on which it is located to identify them positively.

Initial photographs should show the mark as it actually appears and its overall relationship to other objects at the scene. You should include an ordinary ruler and marking data in each picture to provide the laboratory examiner a scale of measurement for examination and comparison purposes.

Make a cast or a mold from a tool mark only when you have good reason for not removing the original evidence.

An impression found on wood or on a metallic surface may be cast with modeling clay or plasticize. These materials do not require any special preparation before use, nor are they likely to damage a tool mark if the frost casting attempt is unsuccessful. A reproduction of the tool mark itself maybe made from this cast using plaster of Paris. Ordinarily, it is not necessary to reproduce a mark on a wooden surface because of the ease with which the original evidence may be removed.

When it is necessary to make a cast of a mark the material best suited for reproduction will be determined by the shape and type of mark to be reproduced. Flat tool marks, hammer marks, chisel cuts, and pry marks may be reproduced using a variety of materials. Tool marks in wood, where undercuts are present, will have to be reproduced with a flexible material.

Suitable media, by brand or generic name, include the following:

- Kerr Permlastic
- Silicone rubber
- Dow Corning Silicone Rubber RC 900
- Kerr Perfection Impression Compound
- Plasticize
- Castoflex
- Moulage and Posmoulage
- Wood's metal
- Plaster of Paris

You should not attempt the casting or molding of a tool mark unless you have repeatedly practiced the particular method on a similar wooden or metallic surface of no evidentiary value. Take sufficient care and time to ensure a usable reproduction. Never release the surface bearing the tool mark until you have obtained an accurate reproduction and cleared the release with appropriate legal authorities.

Transmittal to Laboratory

Each piece of evidence should be marked for identification and separately wrapped. Evidence samples should not share the same package unless all danger of intermingling has been eliminated. Tool mark evidence should be wrapped and packaged so that the tool mark and the tool will not be subjected to damage or loss of trace particles.

Laboratory Examination, Findings, and Value

The examination of tool marks and the laboratory's findings are based on the same general principles and technology used in fingerprint or firearm identification. In the laboratory, test marks are made with suspected tools on materials similar to those on which tool marks are present. Tools, as a result of microscopic variations during production, leave individual characteristic traces that will not be reproduced exactly by any other tool. In

all cases, the test marks are compared with the suspect tool marks by using the comparison microscope.

In many cases, the laboratory will find that the suspected tool made the tool mark found at a crime scene. However, it must be realized that such findings are not always possible. Sometimes the material on which the tool mark is found is such that it fails to record the minor tool imperfections needed to positively identify it as having made the evidence mark. In such cases, the examination may provide other information of value as investigative leads.

An examination of tool marks, even lacking a suspect tool, can be of value. A series of burglaries may be linked by a comparison of the tool marks found at each. A matching of the lengthwise markings on two pieces of wire may indicate that both were manufactured at the same time, having been drawn through the same die by the wiremaking machine. The suspect's possession of a piece of wire, matching exactly that found at a crime scene, would indicate that possession was more than accidental. Wood shavings produced by a drill, plane, or other tool capable of producing wood chips, may be identified with the tool producing them.

SERIAL NUMBERS

Serial numbers are placed on many manufactured objects and provide an easy means of distinguishing one from another. Serial numbers may consist, individually or in combination, of numerals, letters, or symbols. Unless special precautions have been taken by the owner, serial numbers are frequently the only method of establishing ownership. Purchasers of articles not serially numbered during manufacture often place their own serial numbers or private marks on the articles to enable them to identify them.

Serial numbers or marks may be stamped, molded, etched, or engraved. Many articles having component parts, such as automobiles, weapons, and watches, bear serial numbers on several of the component parts. If you find an object from which a serial number appears to have been removed, search the object for other numbers, which usually are found in relatively inconspicuous places.

Investigative Leads

Individually owned items bearing serial numbers usually can be traced from the manufacturer, through the wholesaler and jobber to the retailer, and from there to the original purchaser. The military services buy large quantities of items. Often they do not initially record

individual serial numbers, and shipments are accounted for by lot numbers, shipping and receiving documents, and other methods to expedite the movement of supplies.

Often, the manufacturer of a serially numbered item can furnish the lot number or other recorded information on items purchased by the military services. As the bulk shipment is broken down for issue to units, the serial numbers normally are used on records and for identification. A persistent investigator, armed with lot numbers or shipping document numbers, usually is able to narrow the search to the unit of ownership.

Restoration

There is no easy way to determine whether a serial number that has been removed can be restored. Further, there is no field method by which initial experimentation will reveal clues. All items from which serial numbers appear to have been removed should be sent to a laboratory for technical processing. A decision that a serial number cannot be restored is not valid in the absence of laboratory effort at restoration.

Neither the material of the article (wood, leather, metal, or other substance), nor the method used to apply the serial number (stamping, molding, etching, or engraving) automatically preclude restoration. Serial numbers have been restored under the most adverse conditions. Conversely, restoration attempts have been unsuccessful when conditions appeared most favorable.

Jeweler's Marks

While jewelers' marks are not serial numbers, investigative leads available from them and their use in tracing stolen property make it desirable to consider them here. When an item is placed in the hands of a jeweler for repair, it is customary for the jeweler to place a small identifying mark in an inconspicuous place on the item. The identifying mark usually is inscribed with an extremely fine engraving tool under magnification so that the mark usually is visible only under comparable magnification.

Jewelers in the same geographical area usually are familiar with other markings.

When the jeweler who inscribed the item has been located, identification of the person who brought the object to the jeweler may be made. You should not overlook the possibilities inherent in a jeweler's mark.

LAUNDRY AND DRY-CLEANING MARKS

All laundry marks, whether placed on clothing by ships' laundry, civilian laundry or dry cleaner, or an institutional laundry, are designed for one purpose-to identify the owner of the particular item of clothing.

In crimes of violence, parts of clothing bearing laundry marks may be torn from the person of the suspect. In some crimes, such as holdups, outer clothing such as uniforms, overalls, or coveralls maybe worn as a disguise and discarded as soon as possible after the crime was committed. Clothing has been found hidden in trash bins and garbage cans, and the suspect has been identified through the tracing of laundry marks. A fugitive may leave his or her dwelling quickly and leave behind old clothing. You may also make use of laundry marks to identify an unknown victim, or to establish ownership of property.

Examination

Any garment that comes into your possession that requires the identification of its owner should be carefully searched for laundry marks. Take special care during the search if the garment is to be processed for other trace evidence such as hairs, fibers, or soils, to ensure that such evidence is not dislodged and lost.

All parts of the garment should be searched so a hidden mark which may have been placed in an unusual location on the garment, is not overlooked. After an initial search, whether it is successful or not, another search should be made with strong cross lighting to discover old, faded markings. An additional search should be made using ultraviolet light to discover markings that may not otherwise be visible.

The garment should be sent to a criminal investigation laboratory for further examination, with information indicating any discovered markings and the manner or means used to discover them. This will aid the laboratory examiner in the examination and preclude duplication of effort. By use of light sources of varying wavelength, the laboratory examiner may discover markings that otherwise would remain invisible.

Tracing a Mark

Be prepared to spend long hours in the time-consuming task of going through the records of the laundry or dry cleaner. Neither ships' laundries nor civilian laundries and dry cleaners have personnel available to search their records.

In cases involving ships' laundry marks, it is often advantageous for you to check first the personnel office for a possible identification of the suspect by comparing all names starting with the initial letter of the laundry mark and a comparison of the serial numbers. A check of personnel offices of tenant commands and other stations in the area also maybe helpful.

Civilian laundries and dry cleaners often are required to make their marks a matter of record in the local police department. Assistance should be obtained from local police to identify the laundry or cleaning establishment when civilian-type markings are encountered. If such records are not maintained visits must be made to local laundry and dry-cleaning establishments.

BLOODSTAIN EVIDENCE

In crimes of violence, bloodstained evidence, if properly handled, is of great value. Sometimes the evidence may be found in the form of fluid or clotted blood. More often, it maybe discovered in the form of fresh or dried bloodstains. Blood clots and bloodstains require careful examination since no blood clot or bloodstain is so characteristic in appearance that the investigator can definitely ascertain its origin.

Bleeding

The body has a defense mechanism against excessive bleeding. As soon as bleeding starts in any great quantity, the blood pressure automatically drops and, consequently, the rate of bleeding slows.

Blood normally begins to clot after 3 to 5 minutes. As it dries, the clot darkens in color until, when completely dry, it becomes reddish-brown or dark brown. An old, dried blood clot may become so dark as to be almost black. Because of mold, decomposition, or chemical changes, some bloodstains may appear to be black green, blue, or grayish-white in color instead of the usual reddish-brown.

The color of the blood should be noted

If the blood falls on porous material such as cotton, wool, blotting paper, porous brick, or soft wood, the original color may be altered by absorption of the blood into the porous material.

A bloodstain on a dark background may be difficult to recognize. A flashlight may reveal the bloodstain even in daylight, for under artificial light a dried bloodstain may appear as a glossy or flat varnish against a dull background. Indoors, where the amount of light

is limited, dried bloodstains on a dark-colored floor may be made more visible by shining the flashlight beam parallel to the floor rather than perpendicular.

Shape, Persistency, and Age

The shape of the bloodstains may provide important information about the circumstances of a crime. (See fig. 16- 12.) The height from which a drop of blood fell

may be determined in many cases, from the appearance of the bloodstain.

If the height of the fall is short—6 to 12 inches—the bloodstains may appear as circular disks on a smooth surface. If the height is from 12 to 60 inches, the edges of the bloodstain may be jagged. This jaggedness of the edge of the bloodstains increases in direct relation to the height—the greater the height, the more jagged the edges. If a drop falls from a considerable height—2 or 3 yards—it may splash upon impact and form many small bloodstains, generally concentrated around a larger central bloodstain, giving a sunburst appearance.

Drops of blood that strike a surface at an angle may bounce or splash, leaving a large initial teardrop-shaped blot with a series of smaller blots (similar to an exclamation point) trailing off in the direction of fall. Usually the larger splash is made first and the smaller ones afterwards.

Do not make hasty conclusions concerning the direction of travel of the individual from the appearance of the bloodstains. Material upon which the bloodstain rests may alter the original shape of the drop as it strikes, and bodily movement actually may cause blood to fall in the direction opposite that of actual travel of the individual. Shape of bloodstains is also dependent upon the viscosity at the time it drops and the composition of the material it hits.

Occasionally, blood may be identified on a garment that has been washed if the washing is not thorough. If, however, the laundering process is thorough involving the use of soap and hot water, residual bloodstain traces remaining usually cannot be identified as blood. Washing of the hands may fail to remove all traces of blood, especially under fingernails and around cuticles at the base of the nails.

There are no criteria that enable the examiner to judge the age of a bloodstain with any degree of certainty. Clotting time may be altered by many circumstances or influences. Blood usually clots in 10 to 20 minutes. By examining the clot, you may be able to estimate the time elapsed since the stain was made.

Clotting is more rapid on a rough surface. Oily substances not only may increase the clotting time, but also may alter the appearance of the blood. Even the peculiarities of the blood of an individual may affect the clotting time. A single drop of blood that falls on a dry surface, such as a table or wood floor, usually will dry completely in about an hour at room temperature. Blood that has collected in a pool dries slowly depending upon

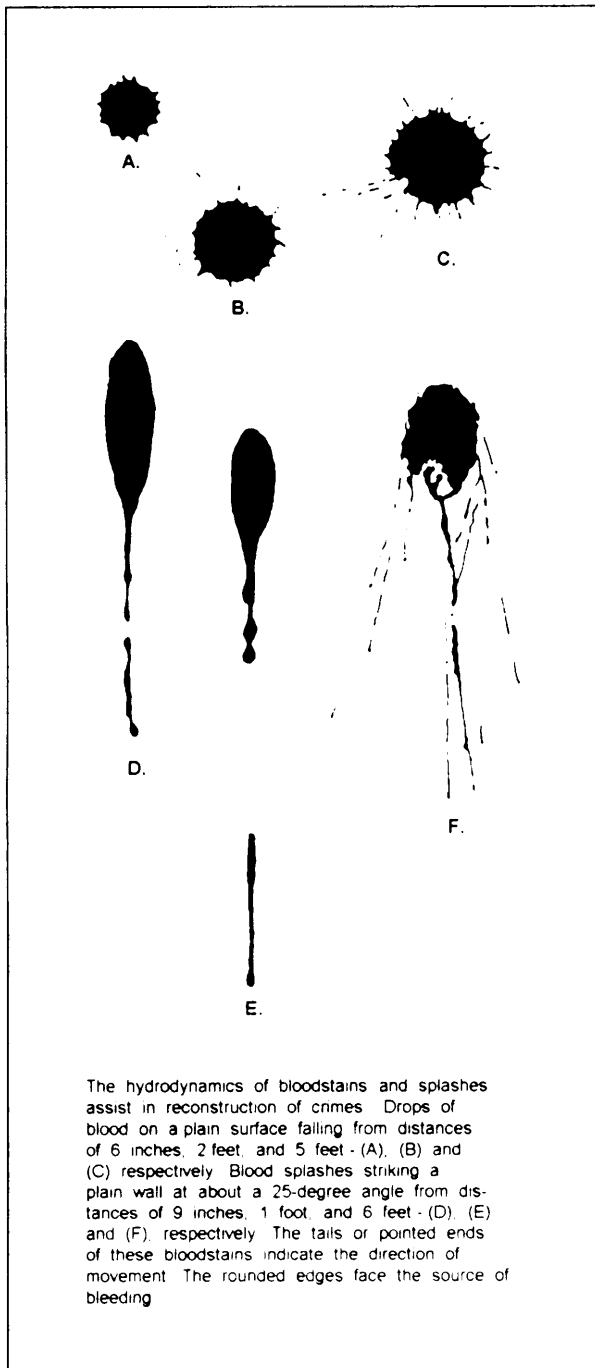

Figure 16-12.-Bloodstains and splash.

the size and depth of the pool formed and the temperature and humidity to which it is subjected.

Source

Microscopic examination may sometimes disclose the origin of the blood because of the presence of foreign particles. Mucus or hairs from the nostrils may be found in blood from the nose. Semen and genital hairs maybe found in blood resulting from rape. Certain cells from the vagina may be noted in blood from menstruation.

Although the presence of foreign elements or particles may lead to conclusions as to the place or origin of the blood, their absence does not necessarily disprove the fact that the blood originated in the part of the body from which it was believed to have come.

Role of the Investigator

You must be aware of what can or cannot be accomplished by expert examination of bloodstained evidence. You must realize that the value that may be derived from the examination of such evidence will depend almost entirely upon using proper methods in collecting, identifying, preserving, and transmitting the specimen to a criminal investigation laboratory.

Marking Evidence

Stained evidence that you have found should be immediately marked so you can positively identify it at any subsequent time. If feasible, place your initials directly on the evidence in an inconspicuous place away from the evidence stains.

The marking of initials directly on evidence is applicable not only to clothing, but also to metallic objects such as axes, knives, crowbars, and hammers. An evidence tag should be attached to the evidence for further identification. If the evidence cannot be marked, the identifying data should be noted on the container in which the evidence is placed. Record all details of the marking of evidence in your notes.

Handling Evidence

A bloodstained article should not be packed for transmittal to the laboratory until it has thoroughly dried. The drying must be a natural process-heat or electric fans should not be used.

If heat is applied to a bloodstain, physical changes will take place within the bloodstain and interfere with its examination in the laboratory. The airstream from a

fan may remove hairs, fibers, or other microscopic particles from the exhibit that might have considerable bearing on the investigation. The fan also may blow extraneous material onto the bloodstain.

Clean wrapping paper should be used for packing bloodstained articles. Each bloodstained article should be wrapped individually before it is boxed for transmittal to a criminal investigation laboratory to prevent stains or other microscopic evidence from being transferred from one article to another.

When bloodstained clothing is submitted to the laboratory, the entire garment, where possible, should be transmitted to assure a complete analysis.

If the bloodstain appears on a large object, such as a rug or a drape, the size of which makes its transmittal impractical, the bloodstained area may be removed. However, for control testing, some of the unstained material from around the bloodstain should be included with the stained part.

In all cases, as much of the dried stain as possible should be submitted. Also, a photo of the item detailing the area should be included.

Where bloodstains appear on fixed objects or objects too bulky to transmit to the laboratory, a different procedure should be used. That portion of the object bearing the stain should be cut off and sent to the laboratory, if possible.

Stains on objects that cannot be cut, such as concrete floors or metal safes, are scraped and the crusty portion of the stain collected on a clean piece of paper. The paper is then folded and placed in a vial or other suitable container. A swab is dampened with either saline or distilled water, and the remainder of the stain is taken by rubbing the swab on the stain. Allow the swab to dry, then place it in a suitable container. For control testing, an unstained area adjacent to the bloodstain should also be swabbed, dried, placed in another container, and sent to the lab for comparison.

If a bloodstain appears on a porous article such as wood or earth, the bloodstain, as well as a portion of the material upon which the stain appears, should be removed so proper control tests may be made. The material removed should be placed in a clean pillbox or similar container, properly labeled on the outside with identifying data, and sealed to prevent loss through leakage.

It is often desirable to obtain liquid blood samples from individuals involved in an incident and to forward them to the laboratory with other evidence. Blood

samples should be drawn by a medical officer or a trained medical technician at a medical installation where proper precautions may be taken to prevent contamination of the samples.

The quantity of liquid blood required for laboratory examination is approximately 5 cubic centimeters or approximately 1/6 of an ounce. Two tubes of blood should be submitted, one with an anticoagulant and one without. No preservative may be added to whole blood, as it interferes with subsequent blood tests. If a delay occurs between the time the blood is drawn and the time it can be forwarded to the laboratory for analysis, refrigerate, but do not freeze, the sampling.

Transmittal of Evidence

All types of blood evidence should be forwarded to a laboratory by the fastest means available to prevent deterioration. The quickest means possible usually will be registered mail or a courier who will travel by air. A liquid blood sample should not be packaged with other specimens because, despite precautions taken in packaging, there may be breakage or leakage and consequent contamination of other evidence in the package. It should be forwarded in a sterile, tightly sealed glass container, properly labeled and packaged to prevent breakage.

Laboratory Examination

Preliminary laboratory examinations of an alleged bloodstain use chemical tests to establish if the stain is a bloodstain. If the results are negative, the stain cannot be blood; if the results are positive, further examination and testing are required. The chemical tests used may not be conclusive, because other substances, common chemical compounds, and certain body discharges may also give positive reactions.

After establishing that the stain is a bloodstain, it must be determined if the blood is of human origin. The evidentiary value may be seriously impaired unless the stain is shown conclusively to be human blood. A suspect may claim the blood to be that of an animal that he or she has handled in some way.

The preferred test for human blood is the precipitin test—a complicated laboratory procedure requiring an adequate amount of blood sample. For this reason, transmit as much of the bloodstain as possible to a laboratory. Minimum specimen quantity necessary for this test cannot be stated because reactions vary according to the condition of the specimen. The laboratory approach to the problem will depend upon

the size and condition of the bloodstain and the nature of the object upon which the bloodstain appears.

If the specimen is found to be human blood, a determination will be made as to what blood group it belongs. The blood of every human being belongs to one of four blood groups—O, A, B, or AB. This grouping is based on the presence or absence in the blood of group specific substances, either singly or in combination. The blood group is not changed by the lapse of time or by disease.

In the continental United States, the approximate percentage of individuals belonging to group O is 43 percent; to group A, 40 percent; to group B, 12 percent; and to group AB, 5 percent.

Laboratory examination may also determine blood group subgroupings, RH factor, MN grouping, polymorphic proteins, and the presence of some diseases.

Grouping dried bloodstains is considerably more difficult than grouping liquid blood. The age of the dried bloodstain or degree of exposure to direct sunlight, extreme temperatures, or other natural conditions may produce changes that reduce the possibility of successful grouping.

For blood group testing, it is necessary to have more than a small spot of blood. If specimen quantity is limited, the grouping tests may have to be eliminated entirely and the examination limited to chemical and precipitin tests. The more specimen furnished, the greater will be the possibility of obtaining maximum information during laboratory examination.

A fairly heavy bloodstain measuring 1/2 by 1/4 inch is generally sufficient for a conclusive grouping determination. Specimens that do not conform to this size must not be arbitrarily discarded as unworthy of examination.

Eighty percent of the population are secretors, or those whose body fluids such as saliva, perspiration and semen permit accurate typing as to blood group.

Accurate groupings have been made of the saliva found on a cigarette butt. The possibility of using the dried remains of body fluids other than blood should never be overlooked.

Accurate blood grouping depends on the ability of the examiner. The tests demand that the examiner have extensive practice and experience, a thorough knowledge of the necessary control tests and techniques, and the ability to recognize all reactions.

The laboratory's inability to provide information concerning bloodstain evidence usually results from unsuitable specimens because of lack of timely submission or external contamination of the evidence.

OTHER BODY FLUIDS

In addition to blood, other body fluids are often found at the scenes of crimes of violence. The other body fluids include semen, saliva, urine, perspiration, pus, milk, nasal mucus, and tears. Criminal laboratory attention is concerned primarily with semen and saliva. Like other evidentiary trace materials, all of these body fluids must be examined by examiners in the laboratory. If they are to be of any value, their initial handling by the investigator is most important.

When the word *stain* is used in the following material, it will refer to stains made by body fluids.

The same factors—the group specific substances—that make it possible to distinguish one blood from another, are present in the cells of every organ of the body and in almost every body fluid.

Medical researchers originally demonstrated the presence of the grouping factors by examining known wet specimens under ideal laboratory conditions. They discovered, for example, that the concentration of the grouping factors in saliva and semen secretions was relatively high and that the concentration in tears, urine, and perspiration was very low. Following medical recognition of the results of this research and the standardization of identification techniques, the identification procedures were applied to stains of such fluids when encountered in medicolegal cases.

A secretor is an individual whose body fluids, as well as blood, may be grouped. A nonsecretor is an individual whose blood may be grouped, but whose body fluids may not be grouped.

The relationship of secretors and nonsecretors is approximately 80 percent to 20 percent respectively. The saliva is the most suitable material for distinguishing secretors from nonsecretors. It is easy to obtain, and if the individual is a secretor, the relatively high concentration of group specific substances will be easily noted. If group specific substances are present in the saliva of an individual, the substances will usually be present in almost every other fluid of that individual's body.

In criminal cases, body fluids usually appear as stains on clothing, bedding, upholstery, or similar objects. In examining a body fluid stain, the techniques

and methods of identification are the same as for bloodstains, but identification is more difficult because of the nature of the stain, its age, and the presence of interfering factors. When handling evidence on which stains may have been caused by body fluids, you should exercise the same precautions prescribed in handling bloodstains.

Identification

Group substances in liquid or dried saliva and some other body fluids may be classified into groups A, B, AB, or O.

As with a bloodstain, the identification of a body fluid stain may be negative, or an inclusive opinion may be reached. Nevertheless, the possibility that valuable investigative leads may result from the expert examination of a body fluid stain should not be overlooked.

For example, if a dried saliva stain is found that contains group substances, the stain could not have been derived from an individual whose saliva does not contain these substances. However, if the dried stain is free of these substances, two possibilities are present: (1) the saliva came from a person who is a nonsecretor, or (2) the specimen of saliva is free of the grouping substances because of contamination or deterioration, and a definite opinion is not possible.

Semen can be typed with some individuals when the specific factors of the blood are carried in the fluid. Saliva normally provides a reliable typing. The typing of urine, and other body fluids, is subject to many more variables, and consequently, reliable typing is more difficult.

A known saliva sample should be obtained from suspects and victims involved to determine if they are the secretor(s), and if so what their blood types are. This is done by having each person chew on a separate 2-inch square piece of thin gauze for about 5 minutes at the back of the mouth. The gauze is then allowed to air-dry completely. It is then placed in a sterile container and sent to the laboratory.

If the gauze is not dried, enzymes in the saliva will destroy the blood group substances, which may lead to an incorrect result in subsequent testing. Blood samples should also be obtained and submitted.

Other Stains

Objects suspected of bearing stains from body fluids other than semen should be handled with the same

precautions and transmitted to the criminal investigation laboratory in the same manner as bloodstained articles.

HAIRS AND FIBERS

The value of hairs and fibers as evidence in criminal cases has been clearly recognized. Hairs and fibers are seldom conclusive as evidence but, in conjunction with other details, have proved to be important and essential aids. You must capitalize on the importance of this type of evidence during the initial phase of the investigation.

The origin and texture of hairs and fibers found at the crime scene or on the body, clothing, or headgear of a suspect or victim, may be exceedingly important as evidence, particularly in assaults and sex crimes. Hairs may be pulled out during the crimes and found at the scene or on the victim. Hair and fiber transfer may occur during any physical contact between the suspect and the victim. Hair may fall out under conditions that the suspect is not aware of and unable to guard against. Properly handled, hair and fibers may provide excellent investigative leads and add to the evidentiary facts being assembled.

Hair

Structurally, a hair is composed of the tip end, cuticle, cortex, medulla, and bulb or root (see fig. 16-13). Each of these provides the laboratory examiner with definite information.

The cuticle is the outer surface of the hair and, when seen under the microscope, appears composed of scalelike flakes, each overlapping the other similar to the overlapping of shingles on a roof or scales on a fish. These scales are known as cuticular scales.

The cortex is the inner portion of the hair and contains the pigmentation or coloring of the hair.

The medulla may be described as the core or center portion of the hair shaft and, under magnification, appears as irregular, spinal, chain, or a continuous dark line of varying width, running up the center of the hair shaft.

Examination of any or all three of these sections may reveal any one of a number of personal characteristics of its sources. Important information may be gained through visual, microscopic, and chemical examinations of the root a bulb of the hair, the shaft, and the tip.

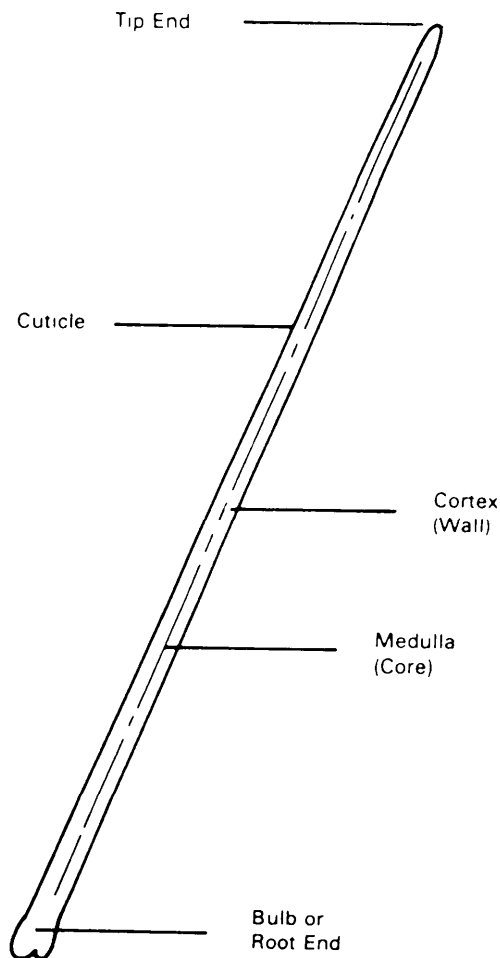

Figure 16-13.-Shaft of hair.

Hair Examination

Through examination, a laboratory will normally first determine if the hair samples are of animal or human origin. If the hairs are animal, a general determination as to species may be made, such as cat, dog, horse, or cow.

In the case of human hairs, laboratory determinations may include the following:

- Race of the person from whom the hair originated (Black Mongolian, or Caucasian).
- Area of the body surface from which the hair originated (head, face, chest, armpit, limb, or pubic area).
- How the hair was removed (naturally or forcibly).
- How the hair had been treated (bleached, dyed, waved).

- Whether the hair was cut with a dull or sharp instrument; recency of cutting; crushed or burned.

- Blood grouping, sex, and age may be estimated or determined.

Laboratory hair comparison conclusions generally will be stated in one of three forms, as follows:

1. Hairs are dissimilar and did not originate from the same individuals.

2. Hairs match in terms of microscopic characteristics, and blood groupings, and originated either from the same individual or another individual whose hair exhibits the same microscopic characteristics.

3. No conclusion could be reached.

Fibers

Contact between two pieces of fabric seldom can be made without an interchange of fiber material. In cases involving physical contact, both the victim's and suspect's clothing may intermingle and exchange fibers. In burglary cases, contacts of clothing with objects should also be considered in the examination of the crime scene and suspect's clothing for fiber evidence. Points of entry, such as windows, or means of access to roofs, ladders, or drain pipes may reveal fiber traces of value to the investigation. Clothing fibers and fibers from the upholstery of automobiles may also be transferred from one to the other.

Fibers generally are classified as mineral (glass asbestos), vegetable (cotton, linen, hemp, jute), synthetic (rayon, nylon, orlon), or animal (wool, silk furs). Classifications vary greatly as to color and type of processing, yarn and thread composition, and end use. Fabrics, tapes, ropes, and similar end products may be subjected to fiber examination and instrumental analysis.

Fiber Examination

Fabric, which is composed of knotted or woven yarns (fibers twisted together), will be grossly examined in terms of color, composition, and construction. Questioned fabrics may be determined to be similar to known fabrics. Positive identification may be made when a questioned piece of fabric may be fitted back into the known fabrics. This type of fabric examination is based on matching broken ends of yarn together.

Fibers will be identified as to type, color, and matching characteristics based on microscopic, microchemical, and melting-point examinations.

Generally, fiber matches are not positive evidence and require substantiation with other corroborative evidence.

Tape examination, similar to fabric examination generally involves matching ends of pieces of tape used at the scene of a crime with the end of tape on a roll found in the possession of a suspect.

Cordage, in the form of ropes and strings, is examined in terms of composition, color, diameter, and construction. The known is compared with the unknown, and occasionally ends may be matched or the manufacturer determined.

Handling and Transmittal

The most difficult task is to initially locate hair and fiber evidence at the scene of the crime. The search must be thorough. Obvious places to search are headgear and clothing, with particular attention being given to linings, pockets, and cuffs. Besides searching the general crime scene area, other areas to search may include the victim's body, underneath the fingernails, and any upholstered surfaces.

Of supreme importance is the basic rule: Avoid contamination of evidence.

Hair and fiber evidence is particularly susceptible to cross contamination, and you must ensure that evidence gathered from the suspect and from the victim is not intermingled. It must be individually collected, properly marked, placed on a clean piece of paper (which is folded and put in a clean container), and properly separated in packaging for transmittal.

Detailed examination of hair and fibers should be left to the laboratory.

When collecting known samples from the victim or suspect, gather a sufficient quantity. Twenty hairs or fabric strands are considered the minimum.

Only a doctor should collect sample hairs from the body of a victim or subject. These samples should be obtained from the various parts of the body possibly involved in the crime. Hair combings and representative samples of cut or pulled hairs should be submitted.

Envelopes sealed around all edges, plastic bags, or pillboxes should be used as containers for hairs and

fibers. The use of tape or glue to hold the hairs or fibers on a surface will interfere with laboratory examination.

FINGERNAIL SCRAPINGS

Fingernail scrapings are rarely exploited to the fullest advantage, although they may provide significant indications in some investigations. The cause of abrasions and scratches found on many parts of the body is frequently a fingernail. The face, neck arms, thighs, and female genitals are the areas commonly attacked and should be subjected to careful medical examination. The form, extent, and location of abrasions will depend on the circumstances in each case.

Resistance offered by the victim during a sexual assault often results in gouging of skin by the assailant's fingernails. Consequently, important evidence often can be obtained by careful examination of fingernail scrapings.

Minute particles of skin, blood, hair, and cosmetics, which often can be found on a suspect and sometimes identified as having come from the victim's clothing, may also be found under the fingernails.

Fingernail scrapings may also assist in determining persons who use narcotics or marijuana.

PROCEDURES FOR TAKING FINGERNAIL SCRAPINGS

In taking fingernail scrapings from a suspect or victim, never use a knife, file, or any other hard, sharp instrument. These are apt to cause bleeding with resultant contamination of the nail scrapings.

The best instrument to use is the blunt end of a flat wooden toothpick, using a different toothpick for each finger. When the scrapings are taken from one finger, the toothpick and scrapings should be placed on a clean piece of paper, which is then folded up and packaged in a suitable container. Each container should be marked to indicate the finger from which the scrapings were taken, and then sent to a criminal investigation laboratory for scientific analysis.

SOILS, ROCKS, AND MINERALS

Soils, rocks, and other minerals may be found on the suspect, the suspect's shoes, clothing, or vehicle; on tools used in the crime; at the scene of the crime; and on the victim. These materials may provide valuable circumstantial evidence. However, such evidence often is overlooked because investigators are neither aware of

its potential value nor of the laboratory services available to exploit it.

Difference in Soils and Rocks

Soils and rocks vary in different locations throughout the world. Differences may be found within small local areas. The differences between two types of soil, such as sand and clay, may be readily recognized. Detailed differences and similarities between samples of similar soils or rocks, however, can be detected only by qualified laboratory chemists.

The following factors account for the differences in similar types of soils and rocks that make them useful as evidence.

Over long periods of time, natural forces have produced variations in the composition of soil and rock deposits, both on and below the surface of the Earth

Humans have caused numerous soil and rock variations.

In mining, agricultural, and industrial areas there is an almost constant mixing and moving of soils and rocks. Materials and minerals are added to and taken from the soil. Crops may add identifiable particles to soils in which they grow. Soils and rocks are added to or are taken from surfaces to make them level, thereby disturbing local geological patterns and further adding to the great variety of soil and rock differences.

Local variation may be caused by addition to the soil of plant wastes, plant products, fertilizers, human and animal wastes, soil conditioning materials, and many other substances.

Soils and Rocks as Evidence

One of the primary uses of soils and rocks as evidence occurs in the comparison of samples from the crime scene with samples on the suspect's clothing or other possessions to determine whether the suspect could have been at the crime scene.

Soil and rock evidence is more apt to be found when the offense was committed out-of-doors or when the perpetrator walked or drove a vehicle on unpaved ground

Such evidence may be derived in the following ways:

- The offender may leave at the crime scene small amounts of rocks and soils that were carried there. In addition to linking the offender with the crime, these soil

and rock particles may provide clues to the offender's former whereabouts and occupation. They may indicate whether the offender walked or rode to the scene.

- The offender may pickup soil and rock materials at the scene.
- The offender may pickup or leave soil and rock evidence.
- In a hit-and-run accident, the offending driver or vehicle may pick up and leave incriminating evidence.
- The impact of the collision may dislodge mud, dirt, and accumulated debris from the undercarriage of the hit-and-run vehicle. Particles may be found on the road or on the body or clothing of a pedestrian struck by the hit-and-run vehicle.
- The vehicle may run off the road or along the shoulder of the road and, in so doing, pick up mud and dirt on its tires and undercarriage.
- The offending driver may dismount to survey the damages, to disengage the vehicle, or to make minor adjustments to the vehicle so that he or she can flee the scene. In so doing, mud or debris may transfer to the offender's shoes, clothing, or into the vehicle.

Other Mineral Evidence

Particles of other mineral substances may be encountered. The most common of these areas follows:

Plaster and building materials. Where a building has been broken into, a variety of building materials may be passed through or damaged. Materials may include plaster, plasterboard, insulation, sheeting, cinder block mortar, and brick. Variations in composition, texture, and color combined with the definite probabilities of transfer to the person or clothing of the perpetrator make the collection and examination of these mineral materials essential.

Insulation. The penetration of the walls of a safe may cause the insulation to be broken. Dust from the insulation may be scattered about the scene and it may get on the clothing of the perpetrator. Close examination of the scene may also reveal clearly defined footprints in the dust that has settled on the floor. Substances used for insulating or fireproofing safes vary according to manufacturing specifications. The exact composition is a trade secret; however, a criminal investigation laboratory has data on the types used by major manufacturers and can conduct comparison and study of evidentiary specimens.

Dust. Dust from a house or other building may get on the shoes or clothing of a person who burglarizes or otherwise illegally enters such premises. Such dust may contain ingredients in proportions and combinations that will enable laboratory chemists to determine that the dust could have come from a certain place. For example:

- House dust may contain lint from clothing, bedding, drapes, and upholstery; wood fibers from the floor and furniture; paint and plaster particles; human and animal hairs and skin cells; soot; plant wastes; and residue of floor waxes and cleaning compounds.
- Dust or grime from a vehicle repair shop is apt to contain metal particles and dust; dust from road surfaces; rubber and paint particles; lint and fibers from automobile upholstery and seat covers; and traces of lubricants, fuels, battery acids, and antifreeze compounds.

Collection of Evidence

Clothing, shoes, and other personal belongings that on detailed visual examination appear to contain soil, rock particles, grime, dust, mud, or similar substances should be seized as evidence. They should be individually wrapped. Clean plastic bags are excellent containers for that purpose.

You should not attempt to remove evidence from shoes and garments, but should submit the clothes in question to the criminal investigation laboratory.

This is suspected of having been used in the crime, or of having been at the crime scene, should be individually wrapped. Each should be placed in a wooden or heavy cardboard carton. The cutting or prying edge of a tool should not come in contact with any hard or abrasive surface. Wrapping must be secure enough to prevent loss or contamination of foreign materials present on the tool.

If a foreign substance is found on an object or structure too large for shipment to the laboratory, you should scrape the substance into a pillbox or similar container. The pillbox should be carefully sealed and marked for identification. Photographs, sketches, and notes should indicate the exact places from which such evidence was removed. Evidence from different areas must be kept separate.

The residue from under a suspect's fingernails may contain traces of substances from the scene or from the body or clothing of the victim. Scrapings should be taken from all of the suspect's fingers. The scrapings

should be kept separate in suitable containers such as small pillboxes.

Collecting Comparison Samples

Always obtain samples of rocks and soils from the scene to be used as standards for comparison with similar substances that may be taken from the suspect. In serious cases, even if there is no suspect, always secure comparison samples. Each sample should consist of about 2 tablespoonfuls of soil.

In taking a sample, it is seldom necessary to go deeper than one-half to three-quarters of an inch. However, if a footprint, tire track or other indentation in question penetrates into subsoil that is different from the topsoil, it may be necessary to secure a sample of both the topsoil and the subsoil.

If soil and rock evidence has been found on a suspect's shoes, a comparison sample should be taken from that portion of a footprint at the scene corresponding to the part of the shoe on which the evidence was found. Comparison samples should be taken from a footprint, tire track or other evidentiary indentation only after a plaster cast has been made. A competent witness should be present when comparison samples are removed, packaged, and marked

Comparison samples should be taken beginning at a starting point, which may be a footprint, a tire track or a place where the suspect would probably have gotten soil on his or her clothing, shoes, vehicle, or tools. Samples should then be taken at varying distances from the starting point to ensure that the samples are representative of the area's soil characteristics. A detailed sketch and notes pertaining to the samples taken, coupled with careful handling to preclude mixing of samples, will help to assure subsequent evidentiary usefulness.

At the scene of a hit-and-run accident, you should secure samples of the soil where the hit-and-run vehicle ran off the road. The road surface should be examined carefully for mud flakes that may have dislodged from the hit-and-inn vehicle. If other vehicles are involved samples for comparison purposes should be taken from the undercarriages of all of them.

When you find a vehicle that you suspect of being the hit-and-run vehicle, secure soil and dust samples from its tires, undercarriage, brake pedals, and floor mats and submit them to a laboratory for analysis and comparison with other evidence and samples pertaining to the case.

Comparison samples from road surfaces and shoulders and from vehicles involved in the hit-and-run accident should consist of approximately 2 tablespoonfuls of soil or dust from each place sampled. All of the evidentiary materials gathered from the road should be collected and submitted to the laboratory.

You should include in your sketch of the crime scene and in your notes the points from which soil and rock evidence and comparison samples were taken. The sketch should contain both compass directions and measured distances.

Packaging and Handling Evidence

Evidence and comparison samples to be submitted to a criminal investigation laboratory should be prepared using the following guidelines:

1. During the collection and packaging of evidence and samples, be careful not to mix any of the items of evidence with each other or with the comparison samples.

2. New or unused medical pillboxes or small cardboard containers with tight-fitting covers (similar to those used for packaging ice cream), sealed tightly with cellophane or other adhesive tape, are suitable for packaging dry soil samples. If the soil samples are wet they should be permitted to dry naturally in a dust-free room. Soil samples should not be dried by artificial heat.

3. Soil and rock evidence or comparison samples believed to contain petroleum or other volatile materials should be packed promptly into small mason-type jars with tight-fitting lids. The lids should be screwed on tightly and the edges sealed with wax.

4. Individual containers, marked for identification and sealed to prevent leakage or contamination, should be packed into a large substantial container for shipment to the laboratory.

5. Excelsior, cotton, or crumpled paper should be used to fill any vacant spaces in the package to provide additional protection for the individual samples.

Laboratory Examination

Given adequate samples that have been correctly collected and identified laboratory personnel may do the following:

1. Ascertain whether two samples of rock or soil could have come from the same location. A more positive statement cannot be made, since it is possible,

though not likely, that samples from two different places may be identical.

2. Determine that two specimens of soil and rock could not have come from the same location.

The laboratory cannot specifically determine where a sample of a questioned substance came from merely on the basis of known geological patterns. It may, however, provide you with knowledge of the exact contents of a sample. This information may provide clues to local areas that have the same general type of soil or rock indicated by the laboratory report.

MISCELLANEOUS LABORATORY EXAMINATIONS

In the laboratory, trace evidence is subject to a variety of examinations, some of which require the use of special equipment. The comments that follow are to familiarize you with the general nature of these examinations and with the instruments used. Such examinations normally are not conducted in the field; they are referred to the criminal investigation laboratory.

Ultraviolet Light

Ultraviolet light or "black light" uses visible radiation of a slightly shorter wavelength than normal visible light. Ultraviolet light striking a surface is absorbed by some substances and, in turn, is radiated in a different colored light. In a darkened room, the rays are initially invisible but the effect on the substance is visible in that the light emission phenomenon resulting is one of fluorescence.

Numerous field uses may be made of ultraviolet light, and laboratory examinations may include the following:

1. Use of reflected ultraviolet light, or the fluorescence induced by it, often can quickly and easily indicate similarity or differences in a variety of substances. Stains on clothing that are not visible when viewed under ordinary light may become visible when viewed under ultraviolet. The grayish-white fluorescence of semen may be differentiated from the yellowish-green of urine.

2. Glass samples, similar in appearance and color under normal light, may be differentiated under ultraviolet. During the manufacturing process, trace materials may be introduced into the constituents purposely or accidentally, and the glass samples can be differentiated by their fluorescent or reflective qualities.

3. Cosmetics, such as fingernail polishes, lipsticks, and rouge usually have distinguishing colors of fluorescence under ultraviolet light.

4. The paper and inks of documents usually show clearly their similarities or differences under ultraviolet light. Glues and other similar adhesives used to reseal envelopes usually can be distinguished by an examination under ultraviolet light.

Infrared Light

Infrared light is of a slightly longer wavelength than normal visible light. It has no fluorescent effect that can be seen by the unaided eye, but requires examination through infrared viewing equipment. Some materials that do not show a color under visible light do absorb and reflect infrared radiation, which can be detected photographically.

Laboratory applications include the following:

1. Differences shown by infrared light examination of paints and dyes often yield valuable investigative clues. Differences in opacity, transmittance, or reflectance usually are readily apparent.

2. Gunpowder residues on clothing may become visible even when obscured by dyes or stains such as bloodstains. A photograph of the powder residue pattern may permit proximity testing in the laboratory to determine the approximate distance that the muzzle of the firearm was held from the clothing at the time of firing.

3. Inks also may be differentiated by examination under infrared illumination. Erasures on documents, as well as the writing or printing on charred documents, have been deciphered by using infrared light.

Spectrograph

Minute quantities of evidentiary material are often analyzed with the spectrograph, a laboratory instrument that produces a graph showing the basic constituents and trace elements of the substance examined.

When a substance is burned, it sends out energy or light waves which are observed as colors. In the spectrograph, this light is passed through a prism and the resultant color pattern is focused on a photographic plate as a series of parallel lines of varying density. The different lines represent the different elements present, and their density or thickness corresponds to the quantity of the different elements present.

Analysis of this graphic portrayal will determine the nature of the substance and permit graphic comparison of two samples. Useful in analyzing primarily inorganic materials, the spectrograph is used in a criminal investigation laboratory for the examination of such things as paint, glass, dust, safe insulation, soil, wire, and other metals.

Spectrophotometers

Infrared and ultraviolet spectrophotometers permit qualitative and quantitative analysis of a substance through measurement of the substance's absorption of light rays of varying intensity. The laboratory application of this instrument lies primarily in identification and analysis of substances such as drugs, dyes, inks, plastics, oils, rubber, and stains, and in determining color and making color comparisons.

Gas-Liquid Chromatography

Both qualitative and quantitative analyses of a substance or mixture of several substances may be performed on a gas-liquid chromatography (GLC).

The material to be analyzed is injected into the GLC where it passes through a column that separates the components. As each component passes through a detector, the characteristic time to reach the detector and the relative amount of substance is recorded on a graph. Comparison of this graph with the graph of a known sample makes it possible to determine if two substances are of the same compositions.

This method is used primarily in comparison of paint fragments and accelerants found in arsons.

POLYGRAPH EXAMINATION

LEARNING OBJECTIVES: Define the commonly used terms in the field of polygraph examinations. Discuss the use, purpose, capability, and limitations of the polygraph instrument as an investigative aid. Explain the legality of the polygraph, the polygraph technique, the responsibilities of the investigator and the polygraph examiner, the value and most effective uses of the polygraph, and practices that are either prohibited or detrimental to polygraph use.

Conditions under which polygraph examinations may be conducted within the Department of the Navy

are set forth in *Polygraph Examination and Examiners*, SECNAVINST 5520.4. This instruction contains requirements for selection, training, and supervision of polygraph examiners. The Department of Defense (DOD) policy, with respect to the use of non-DOD administered polygraph examinations, directs that such examinations not be accepted in lieu of an examination conducted by a federal polygraph examiner. Instructions in the technical operation of the polygraph instrument or the evaluation of results obtained through its use will not be provided in this manual.

DEFINITIONS

The following commonly used terms are those with which you should be familiar in the field of polygraph examinations.

Polygraph— An instrument designed to continuously record the occurrence of physiological phenomena of the human body on a moving chart. All Navy polygraph instruments, as a minimum, record pulse and blood pressure variations, respiration rate and relative volume, and changes in skin resistance.

Polygraph examination— A series of questions prepared by the examiner, appropriate to the matter under investigation and asked of the person being examined

Authorizing representative— The Director of the Naval Criminal Investigative Service or an authorized representative.

LEGAL STATUS

The polygraph examination is an aid to investigation. Under departmental regulations, a person must agree to the examination after being advised of his or her legal rights. A statement, admission, or confession obtained after appropriate rights warnings may be entered in evidence, and the use of the polygraph does not alter this fact. Therefore, if the examiner receives an oral or written confession, the examiner may generally testify in court about it.

POLYGRAPH EXAMINERS

Only DOD-certified examiners or intern examiners under direct supervision of a certified examiner are authorized to conduct polygraph examinations.

Polygraph examiners within the Department of the Navy are Special Agents of the Naval Criminal Investigative Service (NCIS) or members of the U.S.

INVESTIGATOR RESPONSIBILITY

To a large measure, the success of a polygraph examination depends upon the professional capabilities of you, the investigator. If the case has been investigated properly, the polygraph examiner can contribute to the successful conclusion of the investigation.

Investigator responsibilities include the following:

- You must remember that the polygraph is only an aid to your investigation, and that a thorough, complete investigation must be conducted, aimed at securing and verifying competent evidence to prove or disprove a criminal offense, rather than upon the possibility of self-disclosure induced by a polygraph examination.

- You must obtain authorization for the conduct of an examination from the Director of the NCIS. This is normally done through a local NCIS office.

- You should never attempt to explain the polygraph technique to a potential examinee. Such explanation is only made by the examiner.

A request for polygraph examination will be approved only when the following conditions have been met:

- The investigation by other means has been as thorough as circumstances permit; the subject has been interviewed; and, consistent with the circumstances of the case, development of additional information by means of a polygraph examination is essential and timely for further conduct of the investigation.

- The alleged offense is punishable under the Uniform Code of Military Justice or the U.S. Code by death or confinement for a term of 1 year or more.

- There is reasonable cause to believe the examinee has knowledge of, or was involved in, the matter under investigation.

You should be able to brief the examiner on minute details of the investigation. General facts, theories, and suspicions are not enough. The examiner must have detailed, verified facts.

The following are some of the facts the examiner must have:

- Specific articles or exact amounts of money stolen

- The exact time (if known) the offense occurred
- Peculiar aspects of the offense or any strange or obscene act committed at the scene
- Known facts about a suspect's actions or movement
- Facts indicating a connection between suspects, victims, and witnesses, especially when they deny any connection
- Exact type of firearm, weapon, or tool used
- Results of laboratory tests
- Background information pertaining to the suspect or subject

You should inform the examiner of any unpublicized facts of the offense, particularly those expected to be known only to the victim or offender. These could include the exact amount of money stolen, type of tools used, or method of entry. The examiner may use specialized techniques for the polygraph test if in possession of certain facts that only the suspect could know through participation in the offense under investigation.

You must be immediately available during the polygraph examination to assist the examiner should a matter arise with which the examiner is not familiar.

Prohibited Practices

You should not subject a person to prolonged interrogation immediately before a polygraph examination. The polygraph technique should never be described as infallible.

The polygraph instrument must not be used as a psychological prop in conducting interrogations.

A prospective examinee is never informed that his or her innocence or guilt will be decided based on the results of the polygraph examination

Do not request a mass screening of possible suspects (large groups, divisions, or departments) to produce a real suspect. This mass screening violates the policy of DOD in that all investigative techniques and procedures have not been applied, leads exhausted, and normal investigative functions accomplished

You do not make the final determination as to the examinee's fitness for a polygraph examination. The examiner will make that determination, or consult with medical, legal, or other personnel as deemed

appropriate. Never assume your investigation is completed with the polygraph examination. The development of information through the use of the polygraph normally leads to evidence or facts which must be collected or evaluated before the successful completion of the investigation.

POLYGRAPH EXAMINER RESPONSIBILITY

The polygraph examiner is responsible for the proper conduct of an examination according to current regulations. The examination must be administered under properly controlled conditions to accomplish the desired objective.

The examiner is prohibited, by regulation, from conducting an examination when, in the examiner's opinion, the person fits one of the following descriptions:

1. Mentally or physically fatigued. This precludes successful administration of the polygraph test, since the basic precept of the polygraph technique depends upon the ability of the subject to respond physically to mental stimuli.

2. Unduly emotionally upset, intoxicated, under the influence of marijuana, a sedative, or stimulant, or is known to be addicted to narcotics. Any of these conditions work to the detriment of the polygraph technique through modification of physical response.

3. Known to have a mental disorder. Psychosis and severe neurosis and, in some instances, pathological behavior patterns render a subject unfit for the polygraph examination.

4. Experiencing physical discomfort of significant magnitude or having physical disabilities or defects that might cause abnormal responses to the polygraph test.

5. Below the age of reason. Young children who have not matured to the extent of fully understanding social responsibilities are not suitable subjects for the polygraph technique.

PROHIBITED PRACTICES

The following is a list of things the polygraph examiner should not do:

1. Conduct an examination unless it has been duly authorized.

2. Formulate questions that probe into a person's thoughts, beliefs, or conduct not directly relevant to the

offense or the polygraph technique. Examples of such subject areas that should not be probed unless directly relevant, are religious beliefs and affiliations, beliefs and opinions regarding racial matters, political beliefs and affiliations of a nonsubversive nature, and opinions regarding the constitutionality of legislative policies.

3. Identify himself or herself as other than an examiner by wearing a laboratory coat to create a clinical appearance, or by making statements that he or she is other than a polygraph examiner.

4. Attempt to make a physical or psychiatric diagnosis of a subject.

5. Examine any person wherein his or her opinion, the person is not a suitable subject for the polygraph examination. If any doubt or question exists in the examiner's mind, the examination should be postponed pending physical or mental evaluation of the subject by competent medical authorities.

POLYGRAPH EXAMINATION

The objective of the polygraph examination is to ascertain if a person's reactions, as recorded indicate truthfulness, so the following maybe accomplished:

1. Verify statement or testimony.

2. Obtain additional investigative leads of an offense, location of evidence, or whereabouts of wanted persons.

3. Obtain facts when a test indicates the person has been deceptive.

Theory

The polygraph technique is based on the theory that a conscious mental effort to deceive on the part of a normal person causes a physiological change that may be recorded by the polygraph instrument. The polygraph instrument does not, and cannot, actually detect truth or deception. It produces a chart record of the physiological changes caused by a person's emotional responses during the test.

By examining the chart record an examiner may form an opinion that a person was not emotionally disturbed by the questions during the test and was therefore, truthful. An examiner may also form an opinion that a person was deceptive since physical responses were present because of the emotional disturbance caused by the questions. Accurate interpretation of test charts depends upon the training,

experience, professional capabilities, and skill of the examiner.

Retest Interview

The examination must be conducted in a quiet, private place. An air-conditioned, soundproof room is best, but a regular interview room or other quiet, private room may be used. A room near an area with a relatively high noise level should not be used. The room should not contain wall ornaments, pictures, or unusual finishings that could be distracting to a subject.

The examiner should greet the examinee in a friendly, business-like manner, introduce himself or herself as a special agent of NCIS, and state that he or she is a certified polygraph examiner. The examinee should be informed of his or her constitutional rights by the examiner after informing the examinee of the offense of which accused or suspected and the purpose of the polygraph examination.

The examinee should be informed whether the examination room contains a two-way mirror or other device whereby the examinee can be observed without his or her knowledge, and informed whether the examination will be monitored in whole or in part by any means.

It should be explained that the examination is entirely voluntary on the part of the subject and that it will be conducted only with his or her written consent.

The examinee should be advised that no adverse action will be taken because of the refusal to consent to an examination, and that no record of refusal will be filed in any personnel records.

The remainder of the pretest interview is devoted to reviewing test questions with the subject to ensure complete understanding of the questions; explaining the mechanical functions of the polygraph instrument; and preparing the subject psychologically for the test. When the examiner feels the proper rapport has been established the testing phase of the examination can begin.

Testing

The exact procedure varies slightly with the person to be tested the facts of the offense, and the results desired. The examinee should be given an opportunity to review the questions before the test.

The length of the polygraph examination will normally vary from 1 1/2 to several hours, depending on

the number of chart series run, physiological tracings recorded thoroughness of examiner interview between chart series, physical and mental condition and requirements of the subject, as well as other delay causative. These normal interruptions or breaks in the polygraph test should not be construed as beginning a new examination, or as requiring additional approval of the authorizing representative.

Post-Test Interview

Upon completion of the actual test phase of the examination the polygraph examiner studies the chart tracings and arrives at one of four conclusions. The conclusions are "No Deception Indicated," "Deception Indicated," "Inconclusive," or "No Opinion."

NO DECEPTION.— The subject is informed that the examination has been completed and the charts will be subjected to a detailed analysis. The subject is assured that evaluation and review of the charts will be accomplished in a few days and that the investigator assigned to the case will be furnished the results at that time.

It should be emphasized to the subject that if no contact is made, he or she may be assured that the responses to the specific examination questions did not indicate deception. The subject is informed, however, that the examination covered only a specific area of the investigation and that subsequent investigation may develop additional information for inquiry.

At this time, the subject is dismissed from the examination room.

After the subject has left the examination room, the examiner carefully evaluates the charts and questions, considering the thoroughness and validity of the examination just concluded. If any doubts exist, a conference with the investigator may resolve them.

Another polygraph examination may be indicated at a later date, as additional information maybe developed, or other factors arise. An examination at a later date must comply with all procedural rules, be approved by the authorizing representative, and consented to by the individual.

DECEPTION INDICATED.— If deception is present, the examiner then interrogates the examinee and attempts to determine the causes of specific physiological responses on the charts.

INCONCLUSIVE.— When a conclusion cannot be formed following the test phase, or an examination is initiated but cannot be completed until some future

date, the examination is considered inconclusive. This is normally due to a temporary physiological disorder (such as cold or minor injury), instrument failure, or the inability of examiner and examinee to establish rapport on a particular day. An inconclusive polygraph examination may be continued at a later date.

Subsequent examination may be made by the original examiner (normally within 30 days) without obtaining additional approval, although the examinee must consent to the further examination.

NO OPINION.— The examiner may render a “no opinion” conclusion when an examination cannot be completed. This may be necessary should the examinee refuse to continue the examination before the collection of polygraph charts, before sufficient charts have been obtained upon which an opinion of deception or no deception may be based, or the examinee, in the opinion of the examiner, is deliberately distorting the polygraph charts.

The conclusion of no opinion is also appropriate if the examinee suffers from a permanent psychological or physiological disorder, and the examiner is of the opinion that further testing at some future date would be unproductive or unwarranted.

Supervision and Review

Each polygraph examination is carefully supervised or reviewed by an individual who is a certified polygraph examiner and exercises quality control supervision over the polygraph examiner concerned

The supervisory individual reviews the record of polygraph examination with other pertinent investigative information and determines whether it is appropriate to request the individual to undergo a repeat polygraph examination.

Such a request may be made when considered appropriate, whether the individual examined has made significant admissions in connection with the investigation and whether the results of the examination indicate unusual physiological responses.

Determination with respect to further investigation of cases where a polygraph examination has been undertaken is not made solely by the polygraph examiner.

When the initial examination has been interpreted as inconclusive, immediate subsequent examination by the original examiner is not considered a repeat examination. Every effort is made to resolve examinations that have been interpreted as inconclusive.

CRIME SCENE PROCESSING

LEARNING OBJECTIVES: List and explain the objectives of crime scene processing. Describe the crime scene procedure. Explain the importance of sketches and notes in the investigative process. Describe the methods and techniques used in crime scene photography.

Successful crime scene processing depends upon the investigator’s skill in recognizing and collecting items and facts that may be valuable as evidence.

When processing a crime scene, you, as the investigator, should be able to do the following:

- Protect the crime scene from destruction or contamination. (This is the only step the MA should accomplish if the offense committed will subsequently be investigated by the NCIS.)
- Preserve all items and facts of evidentiary value obtained at the crime scene. This includes making sketches and notes; photographing the scene; collecting trace evidence and fingerprints; questioning suspects, victims, and witnesses; and marking evidence.
- Present the findings made from crime scene processing. This is the purpose of protecting and preserving the crime scene.

You must attempt to reconstruct what actually occurred during the crime and, if testifying in court, be able to logically and positively identify all facts and items obtained during your investigation.

CRIME SCENE PROCEDURE

Since the security police or master-at-arms patrol force are normally the first police representatives at any crime scene, they should immediately take steps to protect the scene and should assist you in the examination of the scene. Depending on the type of crime committed and the location, the crime scene is the area surrounding the location, to include all direct traces of the crime. You should note the name and position of the person who notified you, and the time of notification.

Upon arrival at the scene, you should do the following:

1. Record the date, arrival time, and weather conditions.

2. If an injured person is on the scene, arrange for medical attention, identification, and removal. The scene may be disturbed only to the extent necessary to have medical aid rendered to the injured or to have a doctor examine (a) deceased victim(s). Consideration should be given to providing a searched pathway to the victim(s).

3. If the offender is at the scene, make an apprehension.

4. If the scene is not fully protected, ensure its protection by using security police or other responsible persons to keep curious persons away from the scene and to keep witnesses, suspects, and victim(s) present from disturbing the scene.

It may be necessary to reroute traffic or to take other action to prevent any disturbance of the scene until a complete examination is made.

The body of a deceased victim should not be covered until thoroughly processed for evidence. Premature covering could result in destruction or alteration of valuable trace evidence.

Immediate action is taken to protect items of possible evidentiary value that may be destroyed by rain, snow, fire, or other causes.

For example, a raincoat or piece of canvas maybe used to cover impressions in the earth that are exposed to rain. Wooden or pasteboard boxes may be placed over impressions in snow. Items that will melt should be shielded from the sun or other heat sources. Objects such as food and blood should be covered to protect them from contamination.

5. Determine and record the names of persons at the scene who may be witnesses, and separate them. These persons should be removed from the immediate area of the scene as soon as practicable.

6. Conduct preliminary questioning of witnesses, suspects, and victim(s) to determine, in general, the extent of the incident or crime. Record all movements made at the scene and what items persons have touched.

7. Note the names of all persons present. Those present within the immediate area of the scene should be only the minimum needed to assist you. It maybe necessary to request military or other officials present to refrain from examining or disturbing objects or aspects of the scene. Investigating personnel must maintain CONTROL and SECURITY of the crime scene.

Recording

You begin the process of recording pertinent facts and details of the investigation the moment you arrive at the crime scene.

Write down the identification of persons involved and what you see initially. Draw a rough sketch of the crime scene and take an integrity photograph That is done to assure that an image of the crime scene is recorded before the scene is disturbed.

The recording should continue for the duration of the crime scene processing.

Searching for Evidence

Each crime scene is different, according to the physical nature of the scene and the crime or offense involved. Consequently, the scene is processed to develop essential evidentiary facts pertinent to the offense. A general survey of the scene is always made, noting the location of obvious traces of the action, probable entry and exit points used by the offender(s), and the size and shape of the area involved.

In rooms, buildings, and small outdoor areas, a systematic clockwise circle search for evidence is often initiated. (A counterclockwise or any other systematic movement may be just as effective in the search. However, in the interest of uniformity, it is recommended that the clockwise movement be used.)

You examine each item found at the scene to locate anything that may be of evidentiary value.

Give particular attention to fragile trace evidence that may be destroyed or altered if it is not collected immediately.

If any doubt exists as to the value of an item, treat it as evidence until it is proven otherwise. Ensure that each item or area where latent fingerprints may be present is closely examined and that action is taken to develop the prints. Carefully protect any impression of evidentiary value in surfaces conducive to making casts or molds. Photograph the impression and make a cast or mold. Note stains, spots, and pools of liquid within the scene and treat them as evidence. Note any peculiar odors emitting from the scene. Treat as evidence all other items, such as hairs, fibers, and earth particles foreign to the area in which they are found. Proceed systematically and uninterruptedly to the conclusion of the processing of the scene. The search for evidence is initially completed when, after a thorough examination of the scene, the rough sketch, necessary photographs,

and investigative notes have been completed and you have returned to the point from which the search began. Further search may be necessary after the evidence and the statements obtained have been evaluated.

In large outdoor areas, it is advisable to divide the area into strips about 4 feet wide. The search starts at one end and moves back and forth across the area from one side to the other. A grid search takes place after a

strip search is completed. It covers the area in a similar manner, but from end to end (See fig. 16-14.)

Indoor or outdoor areas may also be divided into zones or sectors, which are searched as individual areas (see two examples in fig. 16-15).

It may be advisable to make a search beyond the area considered to be the immediate scene of the incident or crime. If so, persons needed to accomplish the search may be secured from a security police unit or other available unit.

All persons participating in the search should be thoroughly briefed on at least the following points:

1. A full description of the item(s) being sought (if known).
2. All information available as to how the item(s) may have been hidden or discarded.
3. The action to be taken when the item is found. The searchers should be emphatically informed that when they discover an item believed to be one being sought, or one similar, they should immediately notify the investigator in charge of the search, refrain from touching or moving the item, and protect the area until the investigator arrives.

After completing the search of the scene, the investigator examines the object or person actually attacked by the offender. For example, a ripped locker

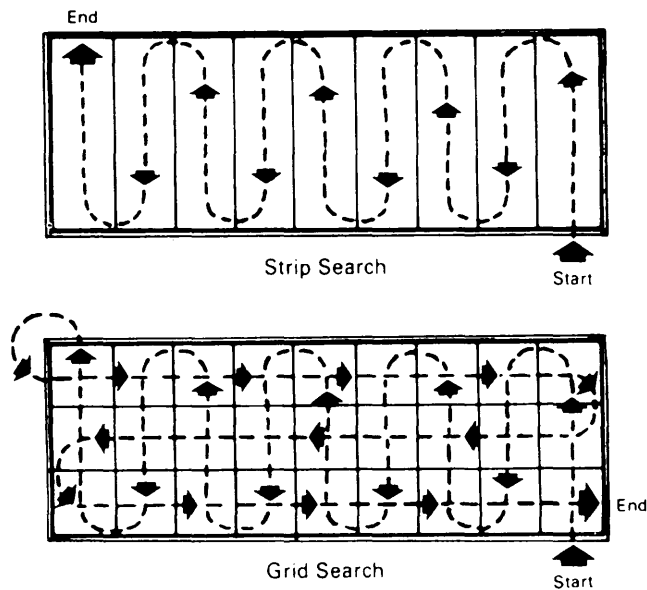
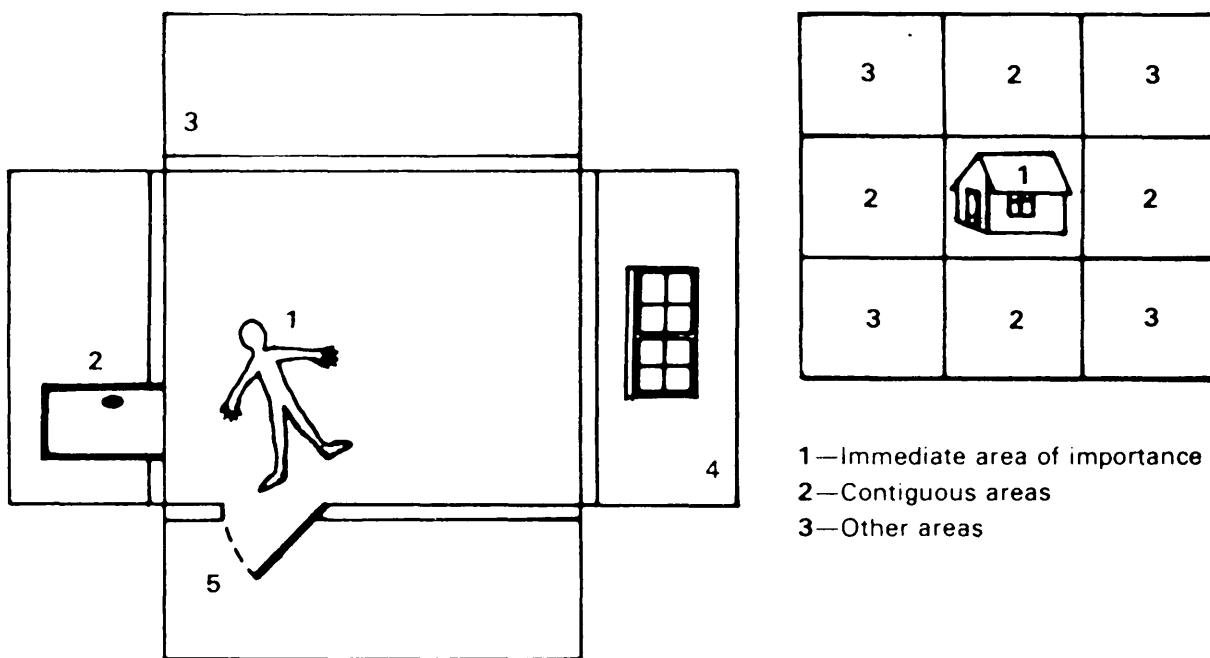

Figure 16-14.-Search patterns.



- 1—Immediate area of importance
- 2—Contiguous areas
- 3—Other areas

Figure 16-15.-Zone or sector searches.

or a desk drawer that has been pried open would be processed after the remainder of the scene has been examined for traces of the offender.

Collecting Evidence

Collecting evidence at a scene is usually accomplished after the search has been completed, rough sketch finished, and photographs taken. It may be advisable under certain conditions to collect various fragile items of evidence as they are found. For example, items of evidence that would be destroyed by the elements or become contaminated despite protective measures, and those items that would impede further search should be collected when they are located and depicted on the sketch. The essential factor is that evidence be carefully and properly collected.

When collecting evidence, handle it as little as possible. Rubber gloves may be used.

See table 16-1 for recommended methods for handling specific items that may be collected at a crime scene.

If, during the collection of evidence, you touch a piece of evidence and leave your fingerprints on the article, make a note of it and inform the laboratory personnel if they make an examination of the evidence. Your fingerprint card and that of the victim(s) should be

forwarded with latent prints to decrease delay of latent identification

It may be necessary to damage, partially destroy, or otherwise decrease the effectiveness of an article to collect important evidence.

For example, it may be necessary to cut the upholstery on a piece of furniture to obtain an area stained with blood or to cut out a section of a wall to collect fingerprints that cannot be collected by other means. Such action is based on the merits of the individual case. To have a door or window processed at a laboratory or held as evidence, it may be removed from a building.

Ensure that necessary measures are taken to protect the contents of a building or room from which a door or window has been removed.

When collecting evidence at the scene for laboratory analysis, the amounts needed will depend on the type of evidence and the tests to be conducted

Marking Evidence for Identification

When marking evidence, place your initials, the date of discovery, and the time on each item of evidence so that it can be identified by you at a later date. These marks should be placed on the item of evidence as soon after discovery as feasible and in a place least likely to

Table 16-1.-Recommended Methods for Handling Specific Item of Evidence

<i>Item</i>	<i>Method</i>
Pistol, US Army, cal. .45, semiautomatic -----	Use the fingers on the knurled grips. Do not touch smooth metal parts. Use prepared box with a peg for the barrel or place flat in box for transporting.
Paper money, documents, paper -----	Use tweezers. Do not place tweezers over any obvious smudge. Place each item in a clean plastic envelope or bag.
Broken glass -----	Use the fingers on the edges of larger pieces. Do not touch flat surfaces. Use tweezers on pieces too small for the fingers. Do not grasp over any obvious smudges. Wrap pieces individually in clean tissue and place in a small box.
Bottles, jars, drinking glasses -----	Insert two or more fingers into large mouth vessels. Place the index fingers on the top and bottom of small mouth vessels. Do not contaminate or spill any substance in the vessel that may be of evidentiary value.
Bullet -----	Use fingers or tweezers with taped ends. Avoid damage to rifling marks on the circumference. Place in a pill box.
Cartridge case -----	Pick up at the open end with tweezers. Avoid scratching. Place in a pill box.
Dried stains on a floor -----	Remove by gouging deeper than the stain with putty knife, wood chisel, or other necessary tool. Place in a pill box or larger similar container.
Dried stains on the smooth surface of furniture	Scrape with pocket knife or putty knife, removing as little of the finished surface as possible.

affect the appearance or monetary or evidentiary value of the item. Evidence that cannot be marked should be placed in a suitable clean container, sealed, and the identifying marks placed on the container. Table 16-2 indicates how and where to mark evidence. Make appropriate notes, to include a description, in your notebook at the time the evidence is marked.

In instances in which several items with the same appearance are collected, place an identifying number on each item and indicate (by the number) in your notes and on the sketch where each item was found

General Evidence Processing

Physical evidence that you obtain must be tagged before it is submitted to the evidence custodian. This action should take place at the scene of the crime when the evidence is collected, at the place of receipt, or as soon thereafter as possible. The tag serves as an aid in the processing and storage of evidence.

Frequently, the successful conclusion of an investigation depends on an accurate evaluation of the evidence. Each item of evidence must be evaluated in relation to all other evidence, individually and collectively.

Your evaluation of evidence begins with the first information received concerning the incident or crime and continues until the investigation has been satisfactorily concluded or discontinued by proper authority. The evaluation may include a discussion of the evidence with supervisors, other investigators, laboratory technicians, or other experts in a given field.

It is your responsibility to ensure that every precaution is taken to preserve physical evidence in the state in which it was received until it is released to the evidence custodian. Preservation includes security and chain of custody. A key-type field safe should be made available to the investigator for temporary storage of evidence during other than normal duty hours.

Table 16-2.-Methods for Marking Evidence

<i>Item</i>	<i>Method</i>
Pistol, U.S. Army, cal. .45, semiautomatic	Use diamond point or carborundum point pencil. Mark on slide, receiver, barrel, and magazine.
Revolver, cal. .22	Use diamond point or carborundum point pencil. Mark on barrel, cylinder, and frame.
Bullet	Use diamond point or carborundum point pencil, or hard, sharp-pointed instrument. Mark on base.
Cartridge case, cal. .38 or larger	Use diamond point or carborundum point pencil. Mark just inside of the open end.
Cartridge case, smaller than cal. .38	Place in a container and mark container.
Knife	Use diamond point or carborundum point pencil. Mark on the blade as near as possible to the handle.
Liquids	Place in clean glass (plastic, if the liquid may freeze and break the container) container and seal to prevent contamination or leakage. Mark container with diamond point or carborundum point pencil. Attach a label and write the necessary data in ink.
Hairs, fibers, dried blood, and powders	Place in clean pill box and seal to prevent contamination. Mark container with ink.
Casts of impressions in soil, snow, or other surfaces ..	Use stick, pencil, or similar marking instrument. Mark on upper surface before cast has hardened.
Handkerchief, towel, flag, or similar item	Use ink. Mark near the edge in an area where there appears to be no deposits of value as evidence.
Coat, dress, and similar items of wearing apparel	Use ink. Mark inside on a double thickness to lessen the possibility of ink staining the outer surface.
Glass, other than small fragments, and similar items.	Use diamond point or carborundum point pencil, a piece of adhesive tape (appropriately marked), or a grease pencil. Mark in area where there appears to be no deposits of value as evidence or place in container and mark container with ink.

Evidence, once in your possession, is released only to the evidence custodian or another person designated by your supervisor.

The scene is not released until all processing has been completed. The release should be effected at the earliest practicable time, particularly in instances in which an activity has been closed or its operations curtailed.

SKETCHES AND INVESTIGATIVE NOTES

Properly prepared sketches and notes are useful to you as reference when questioning witnesses, suspects, and victims; in preparing a report of investigation; and to refresh your memory when appearing in court.

They are also valuable sources of information for both trial and defense counsel. Sketches are frequently introduced in court as evidence and used to acquaint the court with crime scenes and help witnesses orient themselves as they testify. Sketches and notes made during an investigation become the property of the Department of the Navy and are not retained or used as personal property.

Notes or sketches used to refresh your memory during a court appearance may be reviewed by the court. Appropriate attention is given to ensure that all notes and sketches are legible and project clear, meaningful facts. Lack of organization in notes or sketches could adversely influence the weight given to your testimony by a court.

Sketches

A sketch graphically portrays the scene of a crime and items within the crime scene that are of interest to the investigation. The sketch, crime scene photographs, and investigative notes are complementary and are all necessary to effectively process the crime scene.

The sketch provides the best means of portraying distances between objects at the scene. There are two basic kinds of sketches, the rough sketch (see fig. 16-16) and the finished sketch (scaled drawing) (see fig. 16-17). Both types of sketches contain the same general information, but differ according to the technique of presenting the information.

Outline sketches, which generally indicate the dimensions and shape of crime scenes and which are used as interview aids, will not be discussed.

To cover items of interest to the investigation, crime scene sketches should, as a minimum, depict the following:

1. Locations of approaches, such as roadways, paths, entrances, exits, windows, and skylights
2. Size of the area or building
3. Exact locations and relative positions of all pertinent evidence found at the scene
4. Camera locations

In depicting the foregoing, the sketch should do the following:

1. Reflect accurate measurements verified by another person.
2. Indicate compass direction of north.
3. Designate the scale (for scaled drawings only). If no scale is used, state this fact.
4. Use a conventional system of measurement (English or metric system). Paces or steps are not used.
5. Contain a legend that explains all symbols or letters used to identify objects on the sketch. Military symbols are used where practical.

List the report or incident number (if available), offense alleged, name of victim, designation of scene (such as hangar, building, or barracks), location of the scene, date and hour the sketch was started and the name of the persons who made and verified the sketch.

ROUGH SKETCH.— The rough sketch is drawn at the scene of the crime and is not changed after leaving the scene. It is not usually drawn to scale but depicts accurate distances, dimensions, and proportions through use of one of the methods discussed below. The rough sketch is filed with the copy of the report retained by the originating office.

More than one sketch can be made of a particular scene. One may reflect measurements; another may show camera positions; and a third may be required to show locations of items of physical evidence at the scene. In some instances, separate sketches may be the best way to record multiple scenes contained within a larger area of investigative interest, or to provide detailed depictions of isolated locations within a relatively small crime scene. It may be necessary, for example, to sketch separate, limited areas within the scene.

The following are items necessary to prepare a rough sketch:

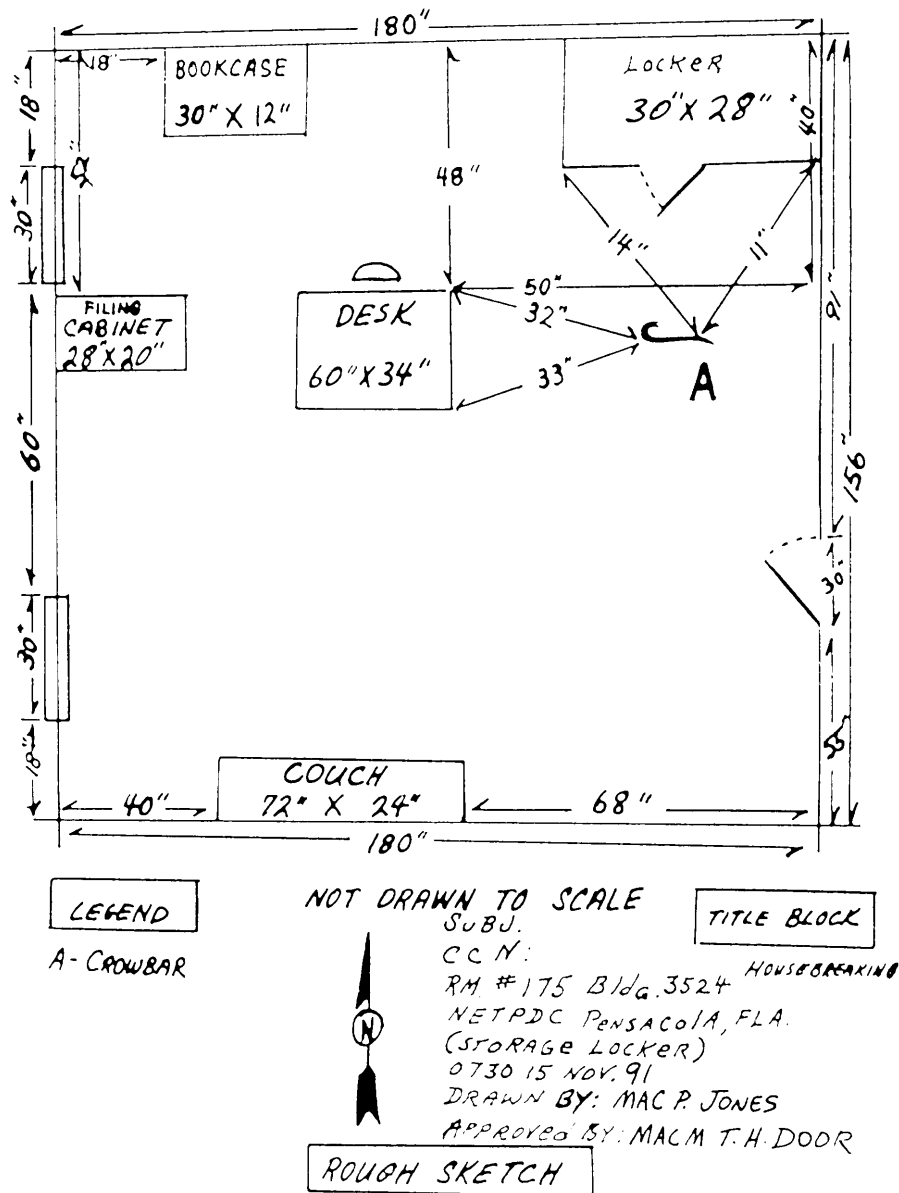

Figure 16-16.-Rough sketch showing evidence measurement and triangulation.

- Soft lead pencil
- Unlined or graph paper
- Clipboard large enough to form a back for the paper
- Steel tape (at least 100 feet long)
- Ruler
- Compass

FINISHED SKETCH.— When possible, the finished sketch is drawn to scale from information on

the rough sketch. When drawn to scale, the sketch need not include figures to show distances. If it is not drawn to scale, this fact should be indicated on the sketch and distances should be shown as on a rough sketch. A copy of the finished sketch is appended to each copy of the report of investigation.

The investigator need not prepare the finished sketch, but must verify its accuracy. It is recommended that the finished sketch be prepared by personnel skilled in such work. The public works officer of the command may be able to provide a qualified person for this task

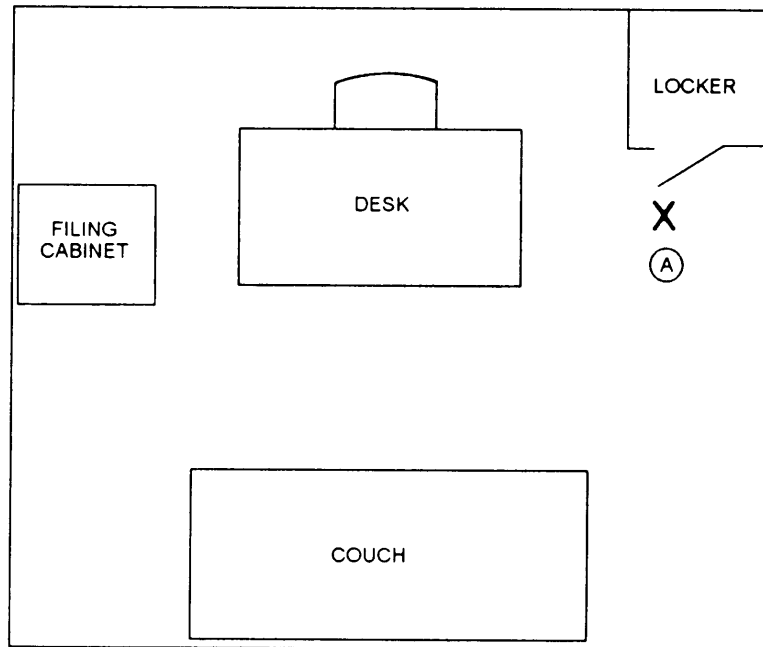

SCALE: 3/8"
= 1 FOOT

LEGEND

(A) = CROWBAR

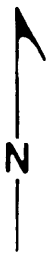

TITLE

REPORT OF INVESTIGATION
OR INCIDENT REPORT #
HOUSEBREAKING
RM. # 175 BLDG. 3524
NETPDC PENSACOLA, FLA.
SKETCHED BY:
DM2 JOHN BRUSH
VERIFIED BY:
MAC P. BOATE

Figure16—17.—Finished sketch.

The name of the person who prepared the sketch is indicated in the report and on the sketch.

If the finished sketch is prepared by personnel of the investigative unit, the following materials are considered necessary:

- Drawing board or table
- Draftsman's T-square
- Pencil and ink drawing compass
- Ink ruling pen
- Lettering and drawing pens
- Black india ink
- Drawing and tracing paper
- Architect scale
- Art gum and ink erasers
- Engineer or architect triangles
- Drawing pencil
- French curve

A projection drawing may be used as the scaled drawing. The projection drawing adds another dimension and in some cases is necessary to effectively

portray the scene. Figure 16-18 is a sample of a projection drawing.

All measurements to a point on a movable object are made from at least two immovable reference points:

Indoor areas. The triangulation method is used for all indoor sketches. In this method, objects are located and depicted by creating a triangle of measurements from two or more fixed points to a single identifiable part of the object to be fixed. Ideally, each object is fixed by two separate triangles related to two different points on the same object. If movable items are to be used as fixed reference points, they must first be fixed themselves.

Outdoor areas. Outdoor areas are considered in two categories-inhabited and uninhabited or remote. The reason for this separate consideration is that inhabited areas normally have easily defined fixed reference points (such as barracks, telephone poles), and the triangulation method can be used for establishing the location of other objects. Uninhabited or remote areas may not have easily defined fixed points within reasonable proximity and objects will have to be located

through use of the intersection/resection method taught in map reading.

Investigative Notes

Investigative notes are prepared for use in recalling places, events, incidents, or other pertinent facts. They are filed with the copy of the report retained by the originating office.

The following are basic principles of note-taking:

1. Notes should be printed or made in legible handwriting, preferably in ink. The ink should not smudge easily.
2. Each page of notes should be identified with your name, the case number (when known), and the date.
3. Short phrases should be used-single words or shorthand notes may not be meaningful at a later date or to other persons.
4. The first notes recorded after a complaint is received include the date and time you received the complaint or information, name of the person reporting

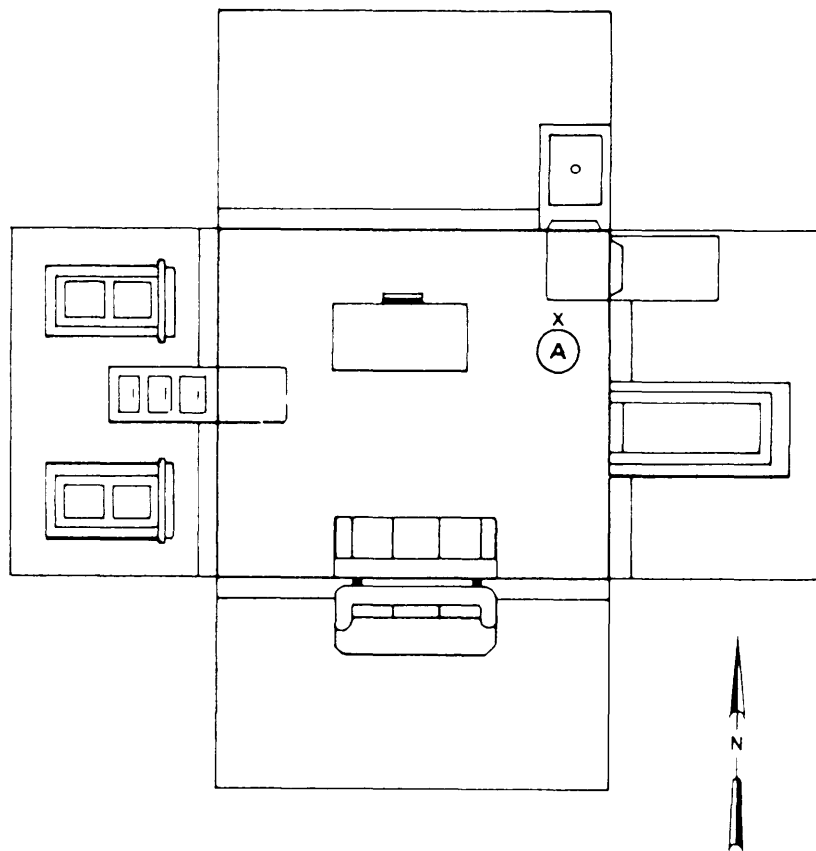

Figure 16-18.-Projection drawing.

the information, names of the victim(s) and the accused or suspected person(s), exact location of the incident or crime, a brief account of the details received, and the complaint or report number, if known. A complete identity of each person should be recorded when first mentioned.

5. Notes should be made when an action is taken, when information is received, and when an event is observed. However, you should not allow your note-taking to adversely affect the questioning of a person who may be distracted by such action and subsequently withhold information.

6. Notes should include a detailed description of any item considered to be pertinent to the investigation. This includes the following:

- Unusual or peculiar marks of identification.
- The exact location where the item was found and the relative distances separating various items.
- Trade names, and serial and model numbers.
- The recording of all identifying marks placed on the item.

7. The notes should indicate action taken by you that may have a bearing on the evidence obtained or that may significantly affect the investigation.

8. Notes should identify each photograph taken of a scene.

9. Notes should be accurate and complete since they will form the basis for the preparation of the formal report of investigation. You may also use the notes to refresh your memory if you appear as a witness in a court.

10. Notes should not be edited or erased. If a mistake is made, the entry should be lined out, initialed, and then rewritten.

CRIME SCENE PHOTOGRAPHY

One of the most valuable aids to a criminal investigation is that provided by photographs. When properly taken, photographs supplement notes and sketches, clarify written reports, provide identification of personnel, and provide a permanent record of fragile or perishable evidence.

The most important rule in crime scene photography is to photograph all evidence or possible evidence before anything is moved or touched.

GENERAL CONSIDERATIONS

Maintaining perspective is the most important consideration in crime scene photography. Photographs are most useful when they most nearly duplicate the exact scene as seen by the investigator with respect to scope, position, color, and form.

Time is also an important consideration. Fragile trace evidence that is subject to nature (such as a footprint in the rain and fingerprints) should be photographed before any other processing is done.

There should not be extraneous objects in the photographs such as investigators, their clothing, or equipment.

Notes should be taken of the type of camera lens and film used, photographs taken, and any information necessary for the photographer to be able to answer "Yes" to the question, "Does this photograph represent the scene as you saw it?"

If it has been determined that an explosive was used and there is residue of explosives in the area, a flash attachment should not be used.

When necessary, all objects should be photographed from different angles to ensure complete coverage.

Evidence flags are useful in marking the location of small items of evidence for a photograph. An example of an evidence flag can be seen in figure 16-19.

When pertinent, photographs should be made of the general scene, approaches to the crime scene, surrounding areas, and closeups of the entrance and exit locations, or those most likely used.

SPECIAL CONSIDERATIONS

Photographs that may aid the investigation of burglary, housebreaking, or larceny offenses are essentially the same. The exterior and interior of the building or room should be photographed, with particular emphasis on suspected or actual points of entry. Any broken or damaged objects should be photographed, especially tool marks. Photographs should depict the point or means of entry and any evidence concerning the target of the offender (such as safe, jewelry box, wall locks, and soon) Trace evidence and fingerprints should also be photographed. When determined, the exit route of the offender should be photographed

It maybe helpful to photograph a person who is the victim of a crime such as assault, aggravated assault, or

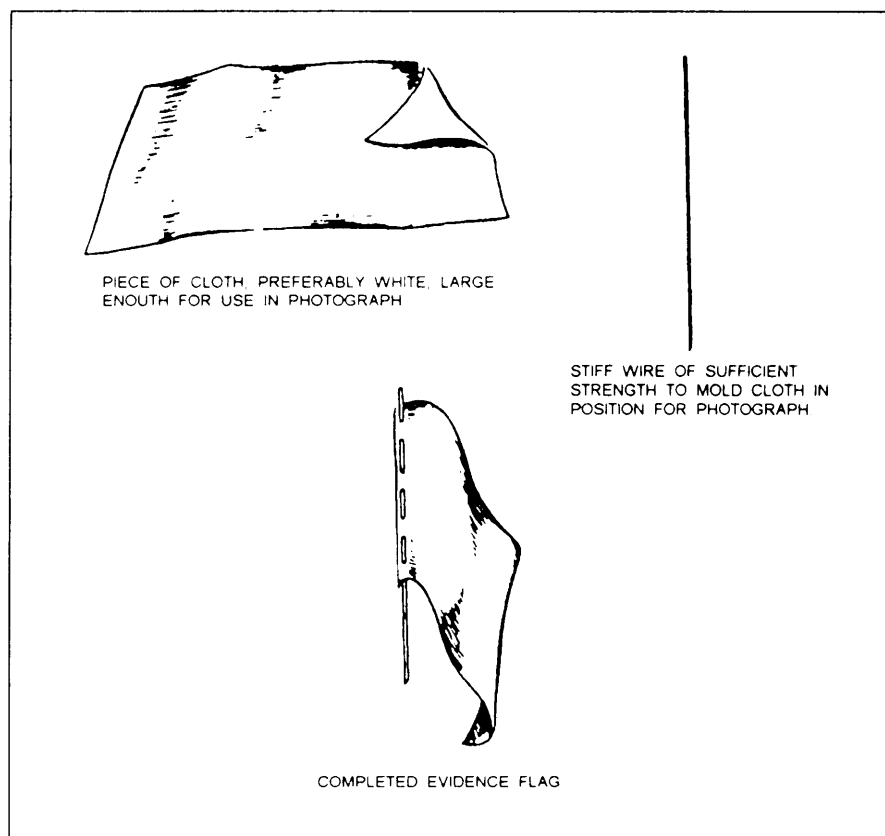

Figure 16-19.-Construction of evidence flags.

a sex offense. Photographs should be made of any wound, injuries, stains, or other trace evidence that may be on the person or the clothing. The area in which the offense occurred should also be photographed. Written permission should be obtained before photographs are taken. If photographs of a body area normally clothed are required, a witness should be present. If the photographs are to illustrate a medical examination, the doctor should be present for verification.

Various other items of evidence should be specifically photographed. This evidence should normally be located in an overall view of the crime scene. Next, a medium-range shot should be taken of the object to show its surrounding area. A third closeup shot of the object should be made to show any peculiarities, followed by the same shot with a ruler in the picture area.

The photographer must photograph all evidence at the scene, since fragile materials could be damaged or destroyed enroute to the laboratory.

BASIC PHOTOGRAPHY INFORMATION

As mentioned earlier, photography can be a great investigative aid. There are several basic photographic terms and equipment with which you should be familiar to take usable photographs.

Lens speed. Lens speed is expressed as the largest f opening a lens has and denotes the amount of light the lens is capable of transmitting to the film. The largest f opening is the smallest f/stop number on the lens (f16 is a smaller opening than f4.5).

Shutter speed. The shutter's purpose is to vary the amount of time during which light is allowed to reach the film. The time that the shutter is open is called shutter speed. This time or shutter speed may be varied, depending on the lighting conditions and the amount of movement to be stopped. For example, the shutter speed must be fast to photograph a moving object without blur. In crime scene photography, objects will probably be still, so the shutter speed may be slower.

Film speed. Film speed identifies the sensitivity of the film to light. Film is given a rating known as ASA Exposure Index, which will be seen as ASA 100 or ASA

800 for example. Film is classified as slow, medium, or fast. A rating up to ASA 100 is slow, ASA 100 to ASA 200 is medium, and ASA 200 to ASA 1200 is fast. The faster the ASA, the less light is required to make an acceptable photograph. Also, the faster the film speed the more grain it will produce in the photograph. Too much grain can confuse or hide small details.

Exposure meter. Also known as light meters, exposure meters accurately measure the light value of a scene or object at which it is pointed. The reading this meter gives is converted into usable shutter speed and lens speed (f/stop). It is advisable to obtain an average between the lightest and darkest part of a scene.

Filters. Filters control the amount of light entering the lens of a camera. This is varied by the color and density of the filter.

Filter Uses

In black-and-white photography, you select a filter of the same color to eliminate the color and a filter opposite it on the color wheel to darken it dramatically. For example, if the subject were blue, a blue filter would lighten it and a yellow filter would darken the same subject. The investigator/photographer should read the film information sheet packaged with each roll or box of film. These sheets recommend filters for use in different situations.

Color Photography

Color film comes in two general categories—positive and negative.

Positive color film produces a positive image known as a transparency (slide). Positive color films are distinctive in that regardless of manufacturer, the brand name ending is always “chrome” (such as Ektachrome, Anscochrome).

Negative color films produce a negative image that can be used to make a positive print, positive transparency, or black and white print. Negative color films are distinctive in that regardless of manufacturer, the brand name ending is always “color” (such as Ektacolor, Ansco color).

Negative color film is best for use in police work because it has a much greater latitude than positive material, which has a greater error factor. Color prints produced for court use must be accurate color reproductions of the subject or crime scene. Color shifts

or impurities can occur when a laboratory is producing color prints, but the technician printing the color can accurately reproduce the colors of the crime scene with a color guide in one of the pictures.

You can aid the color printing technician by photographing an extra shot of the crime scene/subject, and adding a neutral density card (commonly known as a gray card) to the picture. Neutral density cards can be obtained through supply channels. This gray card is important because the color printing technician knows how to reproduce this color, giving him or her an accurate basis for printing all other colors in that picture and all other pictures from that roll or box of film.

When attempting to present color photographs in court, always have black-and-white prints available in case the court does not accept the color prints.

Infrared and Ultraviolet Photography

All evidence requiring the use of ultraviolet or infrared photography should be sent to criminal investigation laboratory for this specialized treatment.

Some of the ways infrared photography may be used in handling evidence include examination of dirty, burned, or charred documents; writing on documents which has been erased or covered with dark ink; dyed cloth and the structure of the weave of cloth; differences in inks, dyes, and pigments; various stains; and gunpowder residues.

Ultraviolet photography may be used to examine questioned, altered or faded documents; detect invisible inks; examine fingerprints on multicolored backgrounds; and examine seminal stains on clothing.

For further information on forensics refer to OPNAVINST 5580.1 and/or contact local NCIS in your area.

SUMMARY

In this chapter, we explained the proper procedures for fingerprinting followed by an examination of how casts and molds are used in the investigative process. Then we looked at how glass may be an important factor at a crime scene. Next, trace evidence such as tool marks, serial numbers, and other materials were considered. The polygraph as an investigative aid was discussed next, in terms of its uses and limitations. Finally, we covered crime scene processing and the techniques used in crime scene photography.

CHAPTER 17

EVIDENCE CUSTODY

This chapter contains an overview of the handling of, packaging of, and caring for physical evidence. The requirements for evidence custody and control are covered in OPNAVINST 5580.1, the *Navy Law Enforcement Manual*.

PHYSICAL EVIDENCE

LEARNING OBJECTIVES: Explain the importance of physical evidence, and list and define the three general categories of evidence. State the guidelines used to evaluate and identify evidence.

Physical evidence is one of your most valuable assets in pursuing an investigation to a successful conclusion. It produces leads during the investigation and aids in establishing the guilt or innocence of an accused person in a judicial or an administrative proceeding. To achieve the maximum benefit from physical evidence, not only must you be skilled in collecting it, but you must know how to handle and care for it to preserve it for the development of leads, for laboratory examination, and/or for presentation in court.

Such handling and care involves (a) storing the evidence to retain the integrity of the item in its original condition as nearly as possible, (b) maintaining a chain of custody for the item to ensure responsibility and ensure its evidentiary value, (c) proper transmittal of the item to a laboratory for analysis, if necessary, and (d) disposition of the item when it is no longer of evidentiary value.

DEFINITIONS

Evidence is anything that tends to prove or disprove a fact in issue either directly or by inference. Evidence may be physical or testimonial. This section addresses only physical evidence. Physical evidence is divided into three general categories:

Movable evidence— can be picked up at a crime scene or any other location and transported.

Fixed or immovable evidence— cannot be readily removed from a crime scene, because of its size, shape, or makeup (such as walls, telephone poles, and floors).

Fragile evidence— is physical evidence that, if special care is not taken to preserve its state, can deteriorate to a point where it is no longer of evidentiary value. It is difficult to detect. It may be movable or immovable. A shoe print in the snow is actually immovable, but a cast of it can be taken and preserved so as to be admissible as evidence. Fingerprints can be lifted, photographed, or removed, whereas body fluids can be preserved in their natural state (or closely thereto).

EVALUATION

The question invariably arises as to whether an object is or is not evidence. You resolve this question by evaluating the object, circumstances, and conditions at the scene, supporting your decision with good judgment, common sense, and past experiences.

Ask yourself, does the object provide an insight into the execution of the crime? Might it link a suspect(s) to the commission of the crime? Will it establish one or more of the criminal elements that make up the legal definition of the crime being investigated? If the object has even the slightest potential of answering these questions, then it should be processed as evidence.

Two more points need to be considered: First, if in doubt about the evidentiary value of an object, process it as evidence. Second, collected evidence may not only prove guilt, but may also prove innocence.

IDENTIFICATION

The naval security force member who first receives, discovers, or recovers physical evidence must be able to authenticate the evidence at a later date. The ability to identify an object as being the specific one collected by the security force member and to attest to its condition or characteristics relevant to the investigation is paramount.

Correct identification of evidence is accomplished when the security force member who initially takes custody of the evidence promptly marks and tags the item(s) of evidence.

Evidence should be inscribed with the initials of the collector and military date and time. Place the marking so as not to (a) destroy any latent characteristics, (b)

DEPARTMENT OF THE NAVY		1. CASE CONTROL NUMBER(CCN)		
EVIDENCE/PROPERTY CUSTODY RECEIPT		15DEC9_-23490-128-6S1		
2. RECEIVING ACTIVITY Security Department		3. LOCATION NAS Bravo		
4. NAME, GRADE AND TITLE OF PERSON FROM WHOM RECEIVED		5. ADDRESS (Include ZIP code)		
<input type="checkbox"/> OWNER <input checked="" type="checkbox"/> OTHER John A. Doe, YN3 Barracks Firewatch		Patrol Squadron 21, NAS Bravo, 99999		
		6. WORK PHONE 123-4567		
7. LOCATION OF PROPERTY WHEN OBTAINED Locker #21, Room 112, 1st Deck, Barracks B265, NAS Bravo				
8. PURPOSE FOR WHICH OBTAINED		9. TIME/DATE OBTAINED	10. LOG NUMBER	
<input checked="" type="checkbox"/> EVIDENCE <input type="checkbox"/> FOUND <input type="checkbox"/> IMPOUNDED <input type="checkbox"/> OTHER _____		1730/15DEC9		
11. ITEM	12. QUANTITY	13. DISPOSAL ACTION	14. DESCRIPTION OF ARTICLE—MODEL NUMBER, SER. NO., IDENTIFYING MARKS, CONDITION, AND VALUE WHEN APPROPRIATE.	
A	1		Grinder wheel, USN 45-34522, gray in color with #PWC-667 stenciled in black paint on the wheel housing, estimated value \$30.00	
B	1		Socket set, 3/4 inch, stenciled with PWC 5, estimated value \$29.00	
C	1		Screwdriver, straight slot, stenciled USN 16, estimated value \$3.00	
D	1		Screwdriver, Phillips head, stenciled PWC 5, estimated value \$3.00	
E	1		Partial roll of duct tape USN stock #21-445-8894, estimated value \$5.00	
F	1		Panasonic electric typewriter, serial #23884957, with minor property tag #8354, estimated value \$450.00	
***** LAST ITEM				
15. NAME AND SIGNATURE OF WITNESS (If available)		16. NAME AND SIGNATURE OF RECEIVING PERSON		
<i>Floss A. Brush</i> MAC Floss A. Brush		<i>Jack R. Frost</i> MAJ Jack R. Frost		
17. CHAIN OF CUSTODY				
ITEM	DATE & TIME	RELEASED BY	RECEIVED BY	PURPOSE
A-F	15DEC9_ 1845	NAME Jack R. Frost	NAME Temporary Evidence	Temporary Storage
		ORGANIZATION NAS Bravo Security	ORGANIZATION Locker #1	
		SIGNATURE <i>Jack R. Frost</i>	SIGNATURE	
A-F	16DEC9_ 0730	NAME Temporary Evidence	NAME Water T. Door	Evidence Custodian
		ORGANIZATION Locker #1	ORGANIZATION NAS Bravo Security	
		SIGNATURE	SIGNATURE <i>Water T. Door</i>	
F	16DEC9_ 0930	NAME Water T. Door	NAME Paul T. Boat	Referred to NIS
		ORGANIZATION NAS Bravo Security	ORGANIZATION NAS Bravo NISRA	
		SIGNATURE <i>Water T. Door</i>	SIGNATURE <i>Paul T. Boat</i>	

OPNAV 5527/22 (12-82)
SNO107-LF-055-2810

CHAIN OF CUSTODY CONTINUED ON REVERSE

LOCATION _____

Figure17-1.-Evidence/Property Custody Receipt (OPNAV Form 5527/22).

reduce the function of the object, or (c) devalue it. Common sense and an understanding of how the object relates to the commission of the crime will dictate where and how to mark the evidence.

When an item of evidence cannot be marked without marring or destroying evidentiary characteristics, it is placed in a suitable container, sealed, and marked for identification. An evidence tag further serves to identify the evidence.

CHAIN OF CUSTODY

LEARNING OBJECTIVES: Define chain of custody and determine who is responsible for the safekeeping of evidence. Describe the duties of the evidence custodian and identify the forms and records used to safeguard evidence.

The chain of custody begins when an item of evidence is collected by the security force member. Evidence will no doubt be passed from person to person and even activity to activity during the course of an investigation and subsequent adjudication. The written, chronological record of transactions of this type is the chain of custody. Each person who takes physical or even constructive control over evidence must be identified as a part of the evidence chain.

RESPONSIBILITY

Each individual in the chain of custody is responsible for each item of evidence to include its care, safekeeping, and preservation while under the individual's control. When the evidence is not in use by a competent authority, such as a trial counsel, the evidence custodian assumes responsibility.

EVIDENCE CUSTODIAN

The evidence custodian must be an experienced, credible member of the security force. The custodian and an alternate are appointed in writing by the commanding officer. The evidence custodian and, in his or her absence, the alternate should be available to receive and release evidence and attend to other matters relative to the administration of the command's evidence custody system. The custodian is responsible for ensuring the creditability of the entire evidence custody system through the impeccable accountability of each item of evidence in the system.

FORMS AND RECORDS

Management of the evidence custody system is accomplished with the use of various OPNAV forms specifically developed for that purpose. Now let's consider the required forms and records.

Evidence/Property Custody Document

The OPNAV Form 5527/22, Evidence/Property Custody Document, should be used to record all custody transactions from initial collection through final disposition. A properly maintained chain of custody will ensure continuous accountability. This form is hereafter referred to as the custody document. The OPNAV Form 5527/22 is illustrated in figure 17-1.

The custody document is prepared with an original and three copies. Entries should be typed or printed in ink. The form is normally prepared by the security force member who first collects the evidence.

The last, or third, copy is used as a receipt when evidence is received from an individual. The original and other two copies, along with the evidence, are presented to the evidence custodian, who maintains the original and first copy. The second copy is returned to the submitting security force member to be attached to the Incident Complaint Report (ICR).

Evidence Tags

A tag must be attached to each separate item of evidence by the collecting security force member for identification and control purposes. But when a number of items are collected as a single unit of evidence, such as a toolbox filled with tools, a single tag will suffice. A detailed listing of evidence items will be entered on the custody document. The OPNAV Form 5527/17A (card) or 5527/17B (sticker) should be used for this purpose. Both types of evidence tags are shown in figure 17-2.

Evidence Log

The Department of the Navy Evidence Log, OPNAV Form 5527/24, should be maintained by the evidence custodian and should be an accurate accounting of all evidence entered into the system. Evidence is entered into the log chronologically. The following information should be provided in the appropriate column:

1. Log number (Julian date-year-sequential log number)

DEPARTMENT OF THE NAVY EVIDENCE TAG		1. CASE CONTROL NUMBER (CCN) 15DEC9 -23490-128-651	
2. ITEM NO. A	3. LOG NUMBER 099-9-001	4. CODE ---	5. NAME OF PERSON SUBMITTING John A. Doe, MA1
6. DESCRIPTION OF ARTICLE (Include quantity) one grinder wheel, USN 45-34522, gray in color with #PWC-667 stenciled in black paint on the wheel housing.			
7. NAME OF PERSON FROM WHOM PROPERTY SEIZED N/A			

DEPARTMENT OF THE NAVY EVIDENCE TAG		1. CASE CONTROL NUMBER (CCN) 15DEC9 -23490-128-651	
2. ITEM NO. A	3. LOG NUMBER 099-9-001	4. CODE ---	5. NAME OF PERSON SUBMITTING John A. Doe, MA1
6. DESCRIPTION OF ARTICLE (Include quantity) one grinder wheel, USN 45-34522, gray in color with #PWC-667 stenciled in black paint on the wheel housing.			
7. NAME OF PERSON FROM WHOM PROPERTY SEIZED N/A			

Figure 17-2.-Evidence Tags (OPNAV Form 5527/17A and 17B).

2. Date and time received by the evidence custodian
3. Security force member submitting the evidence
4. Subject title (offense) (UCMJ ARTICLE)
5. Evidence description (identifiable but brief)
6. Stowage location
7. Temporary transactions
8. Permanent disposition

An example of a properly filled out evidence log is illustrated in figure 17-3.

All entries must be legible and be made in black ink. Errors should be single-lined-through and initialed by the evidence custodian. The evidence log and all

LOG NUMBER	DATE & TIME	SUBMITTED BY (NAME)	SUBJECT TITLE	EVIDENCE DESCRIPTION	STOWAGE LOCATION	TEMPORARY TRANSACTION	PERMANENT DISPOSITION
018-94-001	0900 18 Jan 94	MA1 Boate	UCMJ 112A	3" x 3" Ziplock bag of white powder	Bin C-3	Sent to NSIC Lab NORVA 21 Jan 94	Destroyed on 03 Mar 94 by Lt Doer MA1 Water
053-95-001	1015 22 Feb 95	MAC Merry	UCMJ 108	Word Perfect 5.1 Program disks 3.5 (5)	Safe 001	Check out to MA1 Water for NJP on 26 Feb 95	Returned to Lt Doer Legal Officer 01 Mar 95

Figure 17-3.-Department of the Navy Evidence Log (OPNAV Form 5527/24).

supporting documentation must be retained for 5 years from the date of last entry.

Active and Final Disposition File

Evidence custodians will maintain an active and a final disposition file. The active file will contain the first copy of each custody document that represents items of evidence pending an active investigation or administrative or judicial proceeding. The final disposition file will contain the original and first copy of custody documents that represent items that no longer have evidentiary value and for which disposition authorizations have been received.

EVIDENCE DEPOSITORIES

LEARNING OBJECTIVES: Define an evidence depository and identify the minimum standards for the physical protection of evidence. Explain combination control and list the requirements for evidence inventories. Describe the method for transfer and shipment of evidence and the steps necessary for delivery of evidence to a laboratory. Describe the conditions under which evidence may be disposed.

Any of a variety of configurations may be used to physically safeguard evidence and thus be referred to as an evidence depository or evidence locker. The needs of the command will dictate the size of the depository.

Minimum standards for the physical protection of evidence are as follows:

- The depository may be a General Services Administration (GSA) approved security container or a strong room as defined by the *Department of the Navy*

- If a GSA container is used, it will weigh at least 800 pounds empty or be secured to the deck or bulkhead in such a manner that the container or the structure to which it is attached would have to be destroyed to remove it.

- If a strong room configuration is used, it should be equipped with shelves, storage bins, lockers, and so on, to facilitate an organized, accessible system of storage.

- Lock-bar-and-padlock-type file cabinets or cypher locks are not authorized for the protection of evidence. Locks with keys are considered less secure than combination locks and should not be used.

TEMPORARY DEPOSITORIES

In some cases, temporary storage of evidence may be necessary or practical. When the evidence custodian or alternate is not immediately available to receive the evidence from the security force member, a limited-access, secure container (such as a drop container) may be used.

COMBINATION CONTROL

Combinations to all evidence containers must be changed at least annually or whenever the evidence custodian, alternate, or security officer changes or when any suspected breach of evidence security occurs.

Under no circumstances will the combination(s) to evidence depositories be disclosed to anyone other than the custodian, alternate, or security officer.

INVENTORIES

A complete inventory of evidence and reconciliation of documents must be accomplished at least semiannually. Any suspected breach of evidence integrity is cause for an immediate inventory.

Inventories will, at the minimum, consist of a reconciliation of the evidence log against the active and final disposition evidence files and a visual accounting of each item of evidence.

Evidence inventories will be conducted by the evidence custodian, alternate, security officer, and a disinterested third party. An entry will be made in the evidence log, showing the date of the inventory and the persons present.

Relief of custodian inventories may be conducted by the evidence custodian and the relieving custodian.

TRANSFER AND SHIPMENT OF EVIDENCE

Physical evidence in the possession of the Navy will, from time to time, require transfer and shipment to another activity or agency, and the chain of custody must be maintained.

Two primary reasons for transfer and shipment are (1) when evidence is shipped to a laboratory for forensic examination and (2) when an investigation originates with one command but is referred to another. Evidence may be transferred temporarily or permanently, hand-delivered, or transferred by registered U.S. mail.

Transfers of evidence are accomplished by the evidence custodian. Local transfers may be hand-carried. The evidence custodian should take care to ensure the evidence is received by the other activity in the same condition as when originally collected. When the evidence must be transferred to an activity geographically distant from your own, package the evidence properly (see appendix II) and transfer it by registered mail.

In either event, the original custody document(s) (OPNAV Form 5527/22) and the first copy from the active evidence file will be signed out in the Released block by the custodian. If the evidence is to be hand-carried, the receiving custodian will sign the Received block of both the original and the first copy. The original is retained by the receiving custodian and stays physically with the evidence. The first copy is retained by the releasing custodian, to be filed in the active evidence file for temporary transfers or in the final disposition file for permanent transfers.

When registered mail is used to accomplish the transfer, the original custody document(s) are signed out as for local transfer by the evidence custodian. The Received block is filled in with Registered U.S. Mail and the registered mail number. The original custody document is packaged with the evidence, and the first copy is retained in the appropriate evidence file (active/final disposition). When the return receipt is received, the evidence custodian should attach it to the first copy.

All transfer transactions, whether temporary or permanent, must be recorded in the evidence log.

When temporarily transferred evidence is returned, the other activity's evidence custodian should have

received and released the evidence on the original custody document. The evidence custodian need only receive and return the evidence into the system, making the required notations on the evidence custody document and the evidence log.

SUBMITTING EVIDENCE TO A LABORATORY

The security force member desiring to submit evidence to a forensic laboratory should do so through the evidence custodian. The evidence custodian is responsible for the proper preparation and transmittal of evidence to the laboratory.

The Naval Criminal Investigative Service (NCIS) operates two regional forensic laboratories (NCISRFL) located in San Diego, California, and Norfolk, Virginia. These laboratories are capable of analysis of suspected drug substances, latent fingerprint identification, questioned document examination, arson debris analysis, serial number restoration, and other types of specialized trace identifications.

Evidence may be submitted to local or state forensic laboratories. The U.S. Army CID Laboratory in Georgia may also be used. Special agents from the NCISRFLs or NCIS are available to provide assistance and answer any questions that may arise.

PREPARATION AND TRANSMITTAL OF EVIDENCE

When using a local or state forensic laboratory, you must first have a memorandum of understanding that allows you to use its facility.

The following nine steps must be followed when preparing evidence for submission to a forensic laboratory:

1. Complete a Forensic Examination Request (OPNAV Form 5527/15) in an original and one copy. An example of a properly filled-out forensic examination request form is illustrated in figure 17-4.

2. Submit the original with the evidence. Maintain the copy in the investigative case file.

3. Each item of evidence should be wrapped or packaged separately.

4. Each item should be labeled to correspond with the entries on the examination request form and packed securely in a box. Documentary evidence may be placed in an envelope or a series of envelopes enclosed in another envelope.

5. The box or envelope must be sealed with evidence tape and initialed in such a way that removing the tape would destroy the initials.

6. The original forensic examination request form and the original evidence/property custody receipt must be placed in an envelope, and the envelope sealed and addressed to the laboratory to the attention of the evidence custodian.

7. The sealed envelope should be securely taped to the box or envelope containing the evidence.

8. The box containing the evidence is wrapped in heavy paper (or in the case of an envelope, enclose it in another envelope). NOTE: Multiple items of evidence may be contained in one outer container. However, items of evidence from different cases must be packaged for shipment separately to avoid cross-contamination and possible chain of custody problems.

9. The sender should place his or her initials or signature across the sealed flap of the inner envelope or across the paper tape used to seal the inner box and then cover the initials with transparent tape.

METHODS OF TRANSMITTAL TO A FORENSIC LABORATORY

Selecting a method of transmittal of evidence to the crime lab depends on the type of evidence and the urgency of need for the results.

There are three methods of transmittal: First-Class Mail, registered mail, freight, or hand-carry.

Chemicals, gases, ammunition, and explosive or inflammable materials may not be transmitted through the U.S. mail. These types of materials may normally be sent by freight or hand-carried as long as compliance with local, state, and federal regulations is met.

Before such items of evidence are forwarded, the lab must be notified that the shipment is planned, and specific information about the item and method of packaging must be included in the notification.

WRAPPING, PACKAGING, AND TRANSMITTING

Evidence should be packaged and wrapped to minimize friction and to prevent shifting, breaking, leaking, or contact with other evidence.

Items such as glass fragments, evidence in glass containers, impressions, casts, ammunition, bullets, cartridge cases, tablets, and capsules, which are

DEPARTMENT OF THE NAVY

FORENSIC EXAMINATION REQUEST

1. CASE CONTROL NUMBER (CCN)
10OCT9 -62740-123-7N2

2. PRIORITY OF EXAM

- Routine
 Urgent
 As soon as possible

3. TO (Include Attention Line)

Supervisory Chemist
 Bldg, CEP-177
 Naval Station Norfolk, VA 23511-6493

4. FROM

Security Department
 Bldg 400
 NAS Bravo 26841-2400

5. CASE FACTS (Brief description pertaining to the requested examination which may assist laboratory personnel in processing the evidence. Include date and place of crime.)

At approximately 1330, 10 Oct 199 MA1 Brush was conducting a Command Authorized Search of Barrack 19, Room 342. Item A (described below) was located in a locker belonging to BOAT, Paul Thomas, assigned to NAS Bravo. The bag and contents were located in a book which had been hollowed out by cutting out a portion of pages.

6. EVIDENCE SUBMITTED

a. Item Number	b. Item Description
A	One plastic bag with approximately 10 grams of green vegetable matter.

7. EXAMINATIONS AND/OR COMPARISONS REQUESTED

Field test conducted indicating a positive reaction for the presence of marijuana. Field Test results (OPNAV 5527/20) attached.

8. SUSPECT'S FULL NAME

BOAT, Paul Thomas

9. VICTIM'S FULL NAME

N/A

10. TYPE OF OFFENSE

Possession of marijuana

11. IS ONE COPY OF EVIDENCE CUSTODY DOCUMENT ENCLOSED?

Yes No

12. HAS OTHER EVIDENCE PREVIOUSLY BEEN SUBMITTED FOR THIS CASE?

No
 Yes (List Lab Report Number)

13. INVESTIGATOR'S NAME AND OFFICE PHONE NUMBER

MA1 Floss A. Brush - DSN: 123-4567 Commercial: (123) 456-4567

14. DISPOSITION OF EVIDENCE AFTER ANALYSIS/COMPARISON

a. Item Number	b. Disposition

15. CERTIFICATION

I CERTIFY THAT THIS EVIDENCE HAS NOT BEEN SUBJECTED TO EXAMINATION BY OTHER EXPERTS FOR THE PROSECUTION IN THE SAME SCIENTIFIC FIELD AS REQUESTED HEREIN.

a. Date	b. Requester Typed or Printed Name	c. Requester Signature
12OCT9_	MA1 Floss A. BRUSH	<i>Floss A. Brush</i>

OPNAV 5527/15 (12-82)

5/N 0107-LF 05/77 11

Figure 17-4.-Forensic Examination Request (OPNAV Form 5527/15).

particularly susceptible to breaking, marring, or other destructive changes, should be packed in cotton or soft paper.

When evidence is to be examined for fingerprints, each item of evidence should be packed in a manner that prevents damage to the fingerprints. This is accomplished by fastening the object in the container so that it will not shift and so that other objects will not come in contact with the areas of the object suspected of containing fingerprints.

The nature of the evidence will govern the use of warning notices to be affixed to the outside wrapper or box, such as Fragile, Expedite, Corrosive.

Items that contain stains, such as clothing with stains of blood or other body fluids, should not be placed in airtight plastic containers. "Sweating" and moisture accumulation may occur within such containers, contaminating the evidence. Such items must be dry before packaging. This caution also applies to fingerprint evidence.

With the exception of explosives (oils and gasoline), liquid evidence should be packed in sterile, all-glass bottles or other containers and sealed with wax or other suitable materials.

In general, small, solid items such as fibers, hairs, paint scrapings, powder, powder patterns, and threads should be placed on separate pieces of plain paper. Fold each piece of paper and pack it in a pill or powder box, paper container, or druggist fold. Seal the container with adhesive tape, wax, or other suitable material.

Documents, exemplars, standards, strings, twine, and rope should be placed in an inner cellophane envelope and an outer manila envelope. Cellophane is not suitable for packing any item that will rust or corrode.

Packages containing items of evidence such as acids, ammunition, alkalies, gasoline, glass fragments, guns, liquids, matches, medicines, chemicals, drugs, and paints, which require careful or selective handling while in transit, should be labeled Corrosive, Fragile, Keep Away From Fire, or Keep Cool, as appropriate.

Federal laws prohibit the transmission of certain types of merchandise through postal channels. If there is any question of mailing, the nearest postmaster should be consulted.

Materials bearing traces of accelerant, like those recovered in an arson investigation, should be sealed in a vaportight container, such as a Mason jar. They should

not be sent in plastic bags because accelerant will leak through plastic.

Growing plant material should not be placed in airtight plastic containers, since moisture accumulates, making examination difficult. Growing plants should either be dried before shipment or wrapped in porous paper, and the laboratory notified in advance of the shipment.

Appendix II lists items of evidence most commonly transmitted to laboratories and the methods of transmittal. If you are ever in doubt about any issue concerning evidence submissions to the laboratory, the NCISRFLs in Norfolk and San Diego have "duty examiners" available 24 hours a day. Weekends and after hours, the duty examiner may be reached by calling COMNAVBASE Norfolk or San Diego Base Police.

DISPOSITION OF EVIDENCE

The final link in the evidence custody chain is disposition. Proper final disposition of evidence is paramount to the integrity of the evidence custody system as a whole.

Any evidence that was used in a judicial proceeding normally is not disposed of until the trial and appeal process has been completed. Authorization disposal of evidence while a case is on appeal must be obtained from the cognizant staff judge advocate or the staff judge advocate of the next senior command. If the evidence was used in a federal, state, or municipal court, the authorization must be obtained from the prosecuting attorney before disposal.

When the evidence in question was used in an administrative proceeding, authorization must be obtained from the staff judge advocate or legal officer of the command that has control over the person against whom the action was taken.

Evidence that was entered into the evidence custody system but not used in a judicial or administrative proceeding nor is pending such a proceeding may be disposed of after a minimum period of 6 months with the security officer's authorization.

When requesting disposition of evidence, the authorizing command/agency may exercise any one of four options:

- Dispose of the evidence appropriately
- Return the evidence to the owner or the government agency that owns or is accountable for the property

- Transfer the evidence to the cognizant staff judge advocate, legal officer, or civil authority
- Retain the evidence in custody

Once final disposal authority has been received and annotated on the evidence custody document and in the evidence log, the chain of custody is complete, and the item should be removed from the evidence system. The original and first copy of the custody document are retained in the final disposition file. All evidence custody documentation should be retained for 5 years from the date of final disposition. For more information on disposition of evidence, see the *Navy Law Enforcement Manual*.

SUMMARY

In this chapter, we explained the importance of physical evidence and listed the three general categories of evidence. Guidelines used to evaluate physical evidence were also considered. The chain of custody for evidence was covered along with the forms and records used to safeguard evidence. Next, we discussed the standards for physical protection of evidence and the methods for transfer and shipment. Finally, we outlined the steps necessary for delivery of evidence to a laboratory, and then covered the procedures for evidence disposal.

CHAPTER 18

ADMINISTRATION

This chapter will provide information regarding managerial and administrative functions you, the Master-at-Arms (MA), will encounter. These duties will be as much a part of your job as supervising the personnel in your division.

ORGANIZATIONAL STRUCTURE

LEARNING OBJECTIVES: Describe the factors that determine the basic structure of Navy law enforcement units. Describe four types of organizational charts.

Because Navy units differ in many ways, a definite organizational structure cannot be prescribed for all Navy law enforcement units. Each command should look at various elements and adjust the organizational structure to fit the needs of the command.

DETERMINING FACTORS

The factors that must be considered in determining the basic structure of the law enforcement office are as follows:

- The mission of the command
- The type of command
- The size, location, and special requirements of the command
- The local operating conditions
- The availability of personnel
- The emphasis to be placed on each law enforcement function

A Navy law enforcement unit should be constructed to accomplish the fundamental objectives of a military organization. The objectives are as follows:

- To accomplish the mission
- To ensure coordination and control
- To fix responsibilities
- To group closely related functions
- To economize on personnel and equipment

An examination of the organization of installations, of commerce and industry, and of public agencies indicates that there are certain basic principles of organization that are successful in accomplishing a mission. That does not imply that these principles are applicable in every situation. They are, however, to be regarded as questions that the organization planner must answer in the light of the organizational structure.

The organization should have a clearly understood objective, and every segment of the organization should understand its purpose in relationship to the accomplishment of the organizational objective.

The responsibility assigned to all segments and members of the organization should be specific, clear-cut, and understandable to avoid duplication, omission, and neglect resulting from an unassigned duty.

Authority to act should be delegated to the lowest level practical and should be sufficient to carry out the responsibilities assigned to that level.

Every member of the organization should report to one—and only one—superior.

Individuals reporting directly to a supervisor should not exceed the number that he or she can control, supervise, or direct effectively. For example, within the military structure the section is most usually thought of as being the smallest element that one individual controls, supervises, and directs. The maximum span of control varies greatly and will depend upon such factors as the following:

- Experience, training, and personality of superiors and subordinates
- Degree of similarity among subordinate jobs
- Distance by which superiors and subordinates are separated
- Complexity of organization

Every member of the organization should know to whom he or she reports and who reports to him or her.

Each necessary function should be assigned to a single segment of the organization. Related functions should be grouped; unrelated functions, separated.

Staff sections should act only within the scope of their responsibilities. Directives to subordinate units should be properly staffed and follow the command channel.

To the maximum extent possible, consistent patterns of organization should be used at all levels.

Authority and responsibility should be sufficiently delegated to free the delegator of burdensome detail. Heads of organizations may thus manage by exception rather than by review of all routine subordinate actions. Hence, they will become involved only in those actions that are out of the ordinary (exceptional) and cannot or should not be handled by their subordinates.

ORGANIZATION CHARTS

Organizational structure should be reduced to writing and/or chart form. This is to relate structure, assignment of functions, and relationships that members of the organization need to know.

There are several types of charts that may be used to portray graphically the plan of organization of a security department. These include the structural chart, functional chart, position chart, and combination chart.

Structural Chart

This is a chart depicting the structure of an organization. Its purpose is to outline the basic relationship of various components of an organization without including an excessive amount of distracting information (fig. 18-1).

Functional Chart

This chart is used primarily to fix responsibilities or duties by assigning them to specific components or

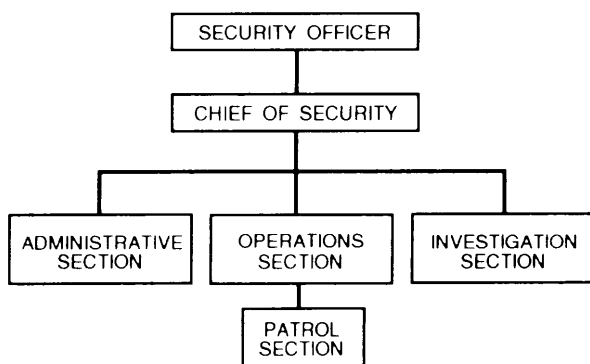

Figure 18-1.—Structure of a typical security department.

segments of an organization. Within each of the various boxes on the chart, a statement or listing is presented of the function assigned to the particular organizational segment represented by that box (fig. 18-2).

Position Chart

This chart shows the names, positions, and titles or grades of personnel as they fit into the plan of organization.

Combination Chart

Structural, functional, and position charts may be combined by including in each box all the data that would be carried separately on two or more of them. This is practical when the organization is simple; however, when many levels and subdivisions exist within an organization, such a chart may become impractical or unmanageable.

In summary, remember that an organization is not static; hence, it must be constantly reviewed to ensure continuing effective direction of all organizational operations.

PLANNING AND PROGRAMMING

LEARNING OBJECTIVES: Explain the difference between a plan and a program. Describe the characteristics of a good plan. List the requirements necessary to support a Navy law enforcement operation.

A plan is a detailed statement of the course of action to be followed in accomplishing the commanding officer's mission. It may be written or oral, as the

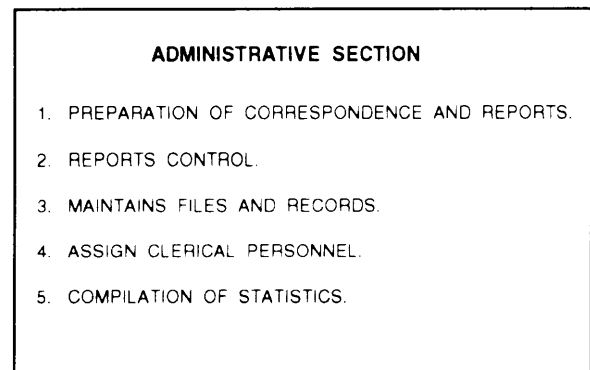

Figure 18-2.—Functional chart of administrative section of a Security department.

situation warrants. A plan normally includes a consideration of the general situation, mission, tasks of subordinate units, administrative and logistical matters, and command and communications matters.

A program is a course of administrative action devised for the accomplishment of a specific objective according to a time schedule. The specifics of the program include time-phasing, the work to be done, and the means to be allocated for the program's accomplishment.

PLANNING

Planning is a continuing process. The necessity of anticipating future courses of action requires that you make continuing estimates of the current and anticipated situation. Planning must be systematic—a clearly and easily understood routine operation.

The planning must conform to the policies and directives of the commanding officer. In the absence of specific or pertinent orders or directives, and pending the approval of the commanding officer, the planning is based upon assumptions that are consistent with sound judgment and a thorough knowledge of the mission. For instance, the planning may be based on the mere anticipation of a forthcoming event, incident, or condition. In the initial stages, some portions of a plan may be based entirely upon assumption. As additional information becomes available, and as the estimate of the situation changes, corresponding modifications should be made in the plan.

A developed plan should be flexible and practical, and should be thoroughly coordinated. Requirements for manpower, equipment and supplies, construction, communications, transportation, and similar factors are essential and should be incorporated in the plan.

REQUIREMENTS

Estimating requirements for a Navy law enforcement operation calls for estimates to be prepared within the scope of the directives and assumptions under which you operate.

Units and Personnel

The situation and the mission generally determine the law enforcement unit and personnel that are required for the support of an operation. In recommending requirements, you should consider the following:

- Capabilities of organic units

- Additional support required
- Geographic, social, and political aspects of the area of operations
- Requirements for riot control, for confinement facilities, and for supporting military government.

Equipment

The equipment required by security departments to perform their mission is determined by analyzing such factors as the following:

- organic equipment of assigned and other available security departments
- special equipment needs for riot control and similar needs that may be required
- estimated wear-out, maintenance, and replacement rates

Facilities

The following facilities may be required for the performance of law enforcement operations:

- Headquarters for directing security operations
- Confinement facilities for military prisoners
- Facilities for special activities

The number, size, and location of the facilities are determined by analyzing such factors as the following:

- Assigned missions; for example, law enforcement, traffic control, and circulation control of individuals
- Estimate of military prisoners to be confined

In planning the location of law enforcement facilities, every attempt should be made to consolidate functions that reduce administrative overhead.

WORK PROGRAMS

LEARNING OBJECTIVES: Define work simplification. List and describe several techniques for improving work methods.

An important aspect of management is the accomplishment of assigned tasks economically. To achieve maximum efficiency and productivity, plan

carefully. Make every effort to improve the work situation and to realize optimum use of available manpower and resources.

Work simplification is a commonsense, systematic method of identifying and analyzing work problems, developing solutions, and installing improvements. This will promote better use of equipment, material, time, and personnel, any or all of which maybe in short supply.

Several techniques have been developed that the leading petty officer can use for improving work methods. These techniques consist of analyses of the distribution and volume of work, steps in the sequence of operations, physical motions involved, and space arrangements. All five techniques are not necessarily involved, or even practical to use, when surveying a particular work problem. It is not always possible, for instance, to alter physical arrangements, particularly aboard ship. The conduct of one analysis, however, may reveal the need to conduct another type to achieve maximum use and efficiency.

Keep in mind that the techniques discussed are merely some methods of analyzing work programs. They do not guarantee a cure for any problems uncovered. Careful analysis, however, should lead to the more effective use of available personnel, whether it is through expansion or reduction of work undertaken, through job or responsibility reassignments, or any other action.

CRIME PREVENTION

LEARNING OBJECTIVES: Define the terms used in crime prevention. State the two factors of any criminal act. Explain crime prevention and state the purpose of the crime prevention survey.

Formulating a comprehensive crime prevention program, to be effective both within an installation and the surrounding community, is a command responsibility.

You must elicit the support of the members of the staff and also the members of governmental and law enforcement agencies of the civilian community. That includes all agencies that in some way contribute to minimizing the opportunity to commit crime.

DEFINITIONS

We will now briefly introduce you to some of the more common terms used in crime prevention.

- *Crime*— An act or omission, defined by law, and made by constituted authority through a judicial proceeding for the protection of society.

- *Crime prevention*— The anticipation, recognition, and appraisal of a crime risk, and the initiation of some action to remove or reduce it. Crime prevention is a direct crime patrol method that applies to before-the-fact efforts to reduce criminal opportunity, protect potential human victims, and prevent property loss.

- *Crime prevention inspection*— An onsite evaluation of the crime prevention program of a unit, section, office, or other facility.

- *Crime prevention campaign*— A program designed to deal with the control or prevention of specific types of crime based on patterns of occurrence, offenders, and victims.

- *Crime repression*— The reduction of crimes and offenses through such measures as patrolling, and physical security and crime prevention surveys and inspections. This also includes observing of persons and places considered crime-producing and discouraging military personnel from participating in activities conducive to crime.

- *Crime risk management*— The development of systematic approaches to reduce crime risks.

FACTORS OF CRIME

Usually there are two factors present in the commission of any criminal act: (1) the desire and (2) the opportunity. To have maximum effect, the crime prevention program must be directed toward both of these factors. Crime prevention is designed specifically to nullify the individual's desire to commit criminal acts and to eliminate or neutralize the opportunity of committing such acts. Actual offenses can be minimized, and much effort expended on the prosecution of offenders can be avoided by the following:

- Elimination of the opportunity to commit crime by the application of effective police preventive techniques

- Minimization of desire to commit crime by the application of social welfare techniques available to the commanding officer

PREVENTION OF SPECIFIC CRIMES AND OFFENSES

The Navy crime prevention program is concerned with types as well as the number of crimes and offenses. The effectiveness of crime prevention techniques depends largely upon the nature of the crimes and offenses being committed and the measure of attention that might be reasonably focused upon them. The application of preventive techniques should be made after a careful analysis of the situation has revealed the causative and contributing factors involved. You must be aware of the need for analysis so that in the conduct of your investigation, you will look for causes and be prepared to make recommendations for prevention.

CRIME PREVENTION SURVEY

The Navy crime prevention survey is a professional and technical review and analysis of existing conditions within a command that tend to have a bearing upon criminal conduct on the part of personnel of the command. Such a survey normally is initiated when the offense or incident rate increases and when statistics show that the offenses are occurring in specific areas or at certain off-base establishments.

The objective of the crime prevention survey is to determine the causative factor responsible for the offenses and to enable the formulation of recommendations for remedial action. It determines the nature, extent, and underlying causes of crime; evaluates present crime prevention efforts; and makes recommendations for improvement of crime prevention action. The crime prevention survey is one of the essential component parts of a well-rounded, coordinated crime prevention program. The survey may include detailed review and investigation as to the nature and extent of criminal misconduct involving personnel, military or civilian, of the command. It may also involve an evaluation of specific operation methods and procedures affecting the protection of personnel or property, and it may include an analysis of neighboring civilian environmental factors. The survey may be conducted in reference to a specific command activity or off-base establishment, or be more general in scope. Normally, a crime prevention survey is instituted for one of two reasons:

1. To supply detailed information on which to establish or update the command's general crime prevention program
2. To furnish timely data and technical recommendations relative to crime prevention measures applicable to specific facilities or situations within command areas of interest

Relationship of Crime Prevention Surveys to Physical Security Inspections

Physical security inspections provide an evaluation of all the physical security measures, emergency and disaster plans, and other procedures used to protect an installation or activity within the installation.

A crime prevention survey is an investigation of a specified activity, area, or condition for the purpose of minimizing or eliminating the opportunity or desire to commit or engage in criminal activities, to include malfeasance, misfeasance, nonfeasance, and moral turpitude.

Figure 18-3 depicts the relationship of physical security and crime prevention surveys.

Subjects of Surveys

Factors and conditions bearing upon crime and its prevention within a command may concern activities, areas, places, or units integral to the command. In addition, conditions within areas, places, or establishments located in the civilian community may influence the conduct of both military and civilian personnel of the command. Consequently, a crime prevention survey may embrace not only matters directly under the commanding officer's jurisdiction, but also matters beyond his or her direct control. Since the latter is true, the MA should establish and maintain close working liaison in respect to police intelligence and crime prevention with civil law enforcement officials and agencies in the vicinity of the command.

Activities and areas within the command's jurisdiction and control are subject to direct action and influence, both as to operational features and environmental factors that might tend to influence the conduct of personnel. Physical security measures may largely negate opportunity to misappropriate or destroy government property by persons not authorized to be present within the protected or restricted area. Determination of types and degree of application of such measures are based on conditions revealed as a result of making a physical security inspection.

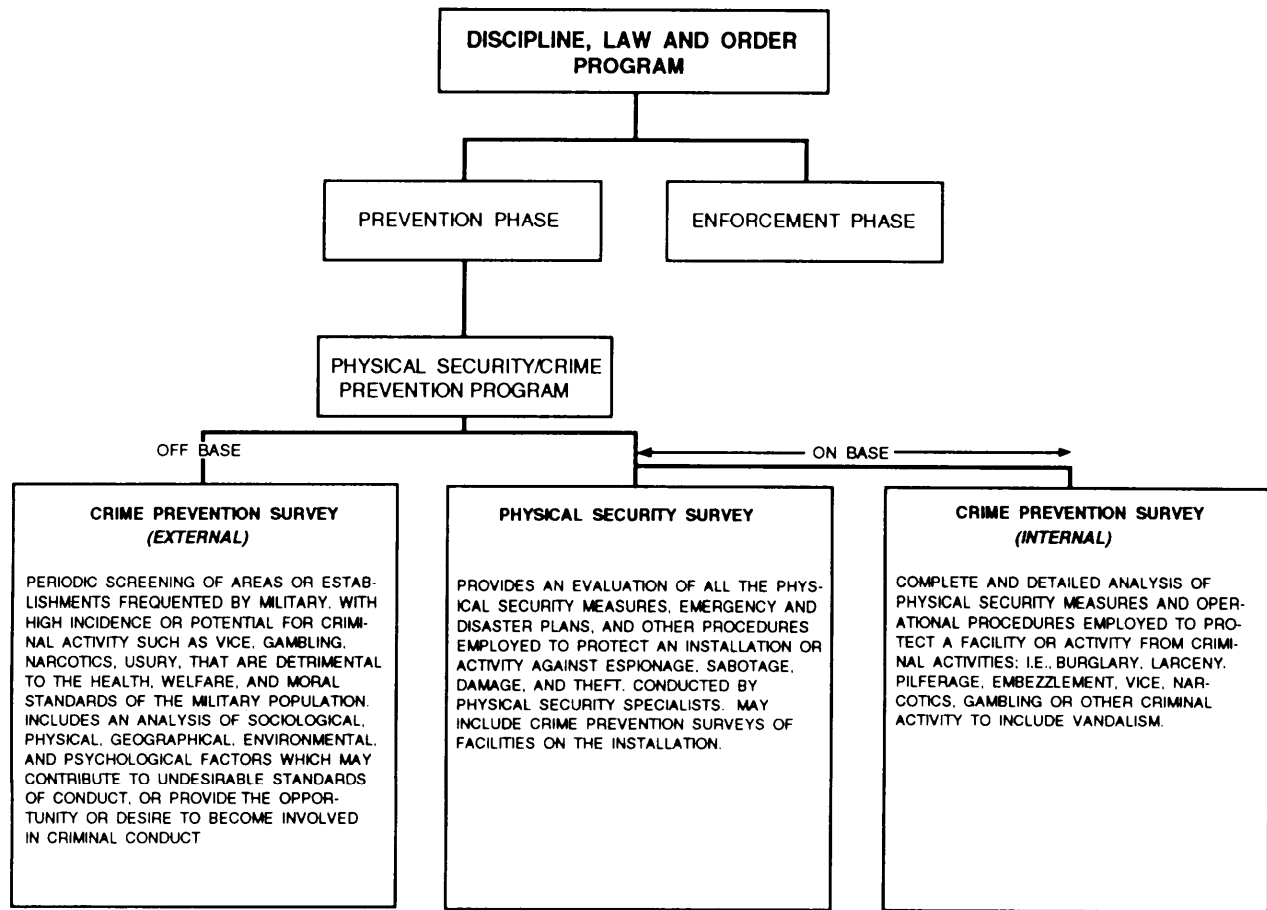

Figure 18-3.-The relationship of physical security and crime prevention surveys.

When persons are authorized to be present either in small or large numbers, physical exclusion and detection measures may be largely inappropriate as protective measures. The commanding officer will need to take cognizance of factors that may tend to create temptation or instigate impulsive misconduct in respect to individuals who are authorized to be present. Operational and environmental considerations requiring the presence of significant numbers of personnel are properly subjects of crime prevention surveys in an effort to minimize the number of personnel in critical areas.

Limited surveys of civilian establishments or areas frequented by command personnel, to observe type and manner of operations, management attitudes and policies, character of patronage, associated activities, physical conditions, and such other factors that may have an influence upon the welfare and the morale of military personnel may in instances be considered desirable or necessary for the information of the

commanding officer. In conducting such surveys, take care to avoid trespass or other violations of private rights and to avoid violation of the Posse Comitatus Act. Obtain permission for entry into nonpublic areas of establishments such as stores, theaters, cafes, and hotel lobbies. The commanding officer has no authority to require cooperation, even the answering of inquiries, on the part of civilian proprietors or authorities.

When a crime prevention survey of civilian establishments or areas is planned, primary emphasis should be placed on those establishments that are frequently visited by military personnel. However, that an establishment has a large military clientele should not in itself be used as justification for a survey. In addition, there should be either a record of criminal incidents in the establishment or area, or reasonable grounds to believe that criminal incidents might develop there. Time and available personnel permitting, establishments and areas with a smaller military

clientele or only a potential military patronage may also be surveyed.

A survey of civilian establishments or areas may develop information on which

- a recommendation that it be placed off limits to military personnel can be based;
- the commanding officer can base recommendations to the civil authorities regarding the elimination of conditions detrimental to the health, welfare, morale, and integrity of military personnel;
- a recommendation for increasing, reducing, establishing, or eliminating patrols can be based;
- investigation of offenses committed by persons subject to the *Uniform Code of Military Justice* (UCMJ) or of offenses against government property under Navy control can be initiated; or
- a recommendation can be made to civil authorities that a cooperative, concerted effort be made to eliminate an undesirable situation or increase the availability of wholesome activities and services within the civilian community.

Survey Techniques and Procedures

Personnel making a crime prevention survey and those reviewing the survey report must constantly bear in mind that every detail peculiar to a particular area, activity, or establishment and relevant to the purpose of the survey be taken into consideration. Investigative fundamentals are applicable to a crime prevention survey. The survey team should use normal investigative techniques of observation, interview, collection of evidentiary data, and methodical notation thereof, if a meaningful, useful survey report and analysis are to be accomplished. Photographs, for example, provide an excellent means of recording and describing what has been observed.

Sometimes the nature of activities being surveyed is technical or involves administrative or other procedures beyond the scope of training and investigative ability of the survey team. When that occurs, assistance should be requested from an agency that can provide such assistance. Examples of procedures that may require outside assistance are accounting, inventory control, fund management, and other similar procedures.

After completing the survey and analyzing the facts obtained, survey personnel prepare their formal survey

report, including appropriate recommendations pertinent to crime prevention.

Good community relations through the maintenance of a professional image are prerequisites to success in crime prevention. The image to be maintained is an image of lawfulness, helpfulness, decorum, effectiveness, pride, esprit de corps, and efficiency. A good public image encourages public support, which, in itself, deters crime and opens up an inexhaustible source of information during the investigation of a crime. A professional image cannot be established in newspapers or through a sales campaign. It must be carefully built on the conduct and efficiency of each member of the unit.

STATISTICAL REPORTS

LEARNING OBJECTIVES: Define the term *law enforcement statistics* and explain how statistics help develop plans and policies. List six preliminary questions that may be answered by crime statistics. Explain how to calculate percentages and how to determine rates. Describe how statistical information is compiled and presented.

The term *statistics* means the science of the systematic collection, classification, tabulation, and interpretation of numerical facts.

The term *law enforcement statistics* pertains to statistics that are of concern to MAs in general and the commanding officer in particular. For example, numerical facts pertaining to absent-without-leave rates, alcohol factor in apprehensions, age distribution of offenders, motor vehicle accidents, motor vehicle thefts, or major crimes committed are of interest to the security department.

The proper collection, classification, tabulation, and interpretation of law enforcement statistics are of great importance to the commanding officer in enforcement and other activities.

There is a direct relationship, for example, between efficiency and effectiveness of law enforcement operations and the accuracy of analyses of general trends encountered during those operations. You can facilitate your findings of solutions to continuing problems, such as high incidence of crimes or accidents, by gathering and studying the pertinent facts. These facts are, or can be made, readily available in data that are contained in numerous records and reports.

By using statistics in one form or another in developing your plans, policies, and operations, you need to have an understanding of elementary statistical techniques in order to do the following:

- Establish standards for the evaluation of the results of your activity
- Summarize the results of prevention and enforcement activities in clear, concise, and meaningful form
- Draw general or specific conclusions of known reliability from law enforcement and other records and reports
- Support recommendations convincingly
- Determine selective enforcement requirements
- Determine laxity and inefficiency
- Be exact and definite in procedure and analysis
- Make valid comparisons of like and unlike data
- Analyze specific factors, such as type, location, and rate of crime
- Determine current trends, such as for crimes or traffic violations
- Make reasonable estimates of future trends
- Formulate short- and long-range plans

USE OF STATISTICS

You must be able to recognize situations in which you can use statistical techniques and concepts to the maximum in order to simplify your work and accomplish the mission.

Specifically, you can use statistics effectively for such purposes as the following:

- Determining unit and individual capabilities
- Making accurate and positive reports on the state of discipline in the command
- Forecasting personnel requirements
- Determining absent-without-leave rates and their causes
- Categorizing apprehensions by nature of offense
- Determining motor vehicle accident causes
- Analyzing venereal disease data

- Collating confinement data

- Projecting operating costs

Law enforcement statistics are not limited to their use in determining areas that require special enforcement attention or to recording and charting criminal occurrences. The preventive responsibilities of the MA also offer a field for the use of statistical techniques. Crime prevention, for example, is one aspect of the preventive field.

Since the purpose of a crime prevention program is to eliminate or nullify crime, the first step is to isolate specific aspects of the problem, such as the extent, character, location, and time of incidents. An accurate determination of these factors cannot be made by rule of thumb or by intuition. A detailed and systematic examination of the facts is required to obtain the essential elements of information for formulating a well-planned and efficient program of crime prevention.

USE OF RECORDED DATA

By a continuing analysis of law enforcement records and reports of criminal occurrences, you are able to detect trends and sensitive areas and to develop preventive measures. The most reliable data available is used in planning, using recorded data of past and current criminal occurrences to guide you in preparing estimates of the crime situation.

Your examination of crime statistics provides the commanding officer with answers to such preliminary questions as those that follow:

- Where are the sensitive areas?
- At what hours do most crimes occur?
- In what age groups does the bulk of the offenders fall?
- What types of crimes are committed most often?
- What is the average length of service of offenders?
- What units of the command have the highest crime rates?

The accuracy of the answers to these questions is closely related to the accuracy of the data examined and to the exactness of the analytical methods used.

You then examine the causative factors of the crimes having high rates. These factors may include an exposure to temptation coupled with a lack of

leadership, inadequate supervision, low morale, or poor law enforcement in civilian communities.

CALCULATING PERCENTAGES AND DETERMINING RATES

A statistical aid to the MA in analyzing statistical data is the calculation of percentages and rate determination. With your information, using either the percentage or rate form (whichever is appropriate), you can see where your problem areas lie.

Calculating Percentages

Percentages are helpful in the presentation of statistical data in briefings or reports. A percentage is that part that is considered in relation to the whole and calculated on the basis of 100. The following is an example of the calculation of percentage:

Example: If 800 offenses occurred during a certain month, 40 thefts would constitute 5 percent of the total number of offenses. To arrive at this result, the following computations are made.

Base figure:	800 (Offenses)
Figure compared to base:	40 (Thefts)

Divide the base figure into the figure being compared to the base and multiply the result by 100 for percentage.

$$\frac{40}{800} \times 100 = 5 \text{ percent}$$

This method may also be used to determine percentage of increase or decrease of military personnel within your area of jurisdiction. The only difference is that an additional computation must be made to determine the actual increase or decrease involved.

Example: Military personnel increased in strength from 4,852 in July to 5,294 in August. The percentage of increase is 9.1 percent.

5,294	August strength
-4,852	July strength
442	

The base figure is 4,852. The figure being compared to the base is 442. The formula for this example is

$$\frac{442}{4,852} \times 100 = 9.1 \text{ percent}$$

Percentage of decrease is calculated in the same manner.

Determining Rates

A rate is generally expressed in terms of frequency per some standard unit, as 100; 1,000; 10,000; 100,000. These figures (100, 1,000, and so on) are arbitrary figures and act as a common denominator to facilitate evaluation and comparison. An example of rate determination is the following:

Example: If 600 offenses occurred during a certain period and 30,000 military were stationed there during this period, the offense rate per 1,000 personnel is 20 (offenses per 1,000). The formula used to arrive at this result is

$$\frac{\text{Number of Offenses} \times \text{Standard Unit}}{\text{Strength}}$$

equals rate per standard unit.

In applying this formula to our example, it would appear like this:

$$\frac{600}{30,000} \times 1,000 = 20 \text{ (rate per 1,000 personnel)}$$

COMPILATION, COLLECTION, AND PRESENTATION OF STATISTICAL DATA

The statistical facts required are, for the most part, to be found in the records and reports. These reports are submitted by personnel who are engaged in the various activities under your control or technical supervision.

You should make a continuing study of these records and reports. Ensure that required statistical data is being reported or recorded and that it is current and accurate. The methods used in securing the data and maintaining the records and reports must be simple, flexible, and commensurate with the personnel available for their preparation.

Essential facts to a problem or situation are extracted from records and reports. These facts are then converted into accurate and understandable measurements of the problem or situation.

Uniform records and reports, together with other locally required records and reports, will contain several facts. Some of these facts will be of assistance in analyzing the character, the extent, the location, and the time of occurrence of incidents that require action.

Essential facts required for statistical analysis are not always available in required records and reports. In this case, you must learn whether the data is available in other staff activities of a higher or lower command. If it is necessary to make original collection of the required

facts, the arrangements are made through authorized channels for such collections.

When a special report on essential facts is received, it may either cover an entire subject or be limited to a sampling of the subject matter. Sampling is a statistical technique. In sampling a representative part of a population or group, carefully chosen samples are usually sufficiently accurate for statistical study. Allowance is made for any margin of error that is considered to be the normal error for that particular method used. Standard sampling principles must be observed if valid results are to be obtained

An aggressive and imaginative MA will use many different techniques in presenting statistical data. Each presentation should be accurately and carefully tailored to fit the situation and the facts being presented. Methods such as the following may be used.

- Written analytical report. This type of report may be required at regular intervals and may, for purposes of clarity, be augmented by appropriate charts or graphs. It provides the commanding officer with a permanent record.

- Graphic presentation. A graph or a chart provides you with a medium for presenting, in a clear, understandable, logical, and interesting manner, a collection of facts. The meaning of these facts presented in another medium might not be clear. A graph or a chart assists the commanding officer to analyze and compare data quickly, permits the condensation of facts and figures, and demonstrates deficiencies and trends. A graph provides the same information as a table but usually has the advantage of greater simplicity and clarity. The following features are found in most graphs:

- A distribution of a group of values or of a trait or characteristic
- A brief, simple, and direct title describing what the graph represents
- The unit or units of measure used

Take care in preparing graphs in order to avoid faulty presentation and interpretation.

Data are usually obtained from various reports, records, or surveys. They appear as unorganized groupings or statements of numbers or facts. By systematic rearrangement of classification, you may give meaning and significance to data. This will facilitate comparisons with other groups of similar data, as well as further analysis of the rearranged facts.

The basic data may be rearranged as follows:

- The largest and smallest numerical values are located.
- The difference between these two values—that is, the range—is determined.
- The values are grouped in the order of their magnitude, in groups of twos, threes, fours, fives, or tens. The size of this grouping factor, called the class interval, normally is such that no fewer than 10 or more than 20 of such groupings result. Consideration is given, however, to the total number of numerical values with which it is necessary to deal.

Fundamentals of Graphic and Tabular Charts

Let's discuss the different types of table charts that are used in the security department to help display information.

CURVE CHART.—The curve or line chart (graph) (fig. 18-4) is probably the most widely used form of graphic presentation. It is very simple to construct and is most effective when the emphasis is on movement rather than an actual amount. The curve chart is normally used when data covers a long period of time. It is also possible to compare two or more series on the same chart. The curve or line chart maybe used to show trends in various enforcement activities, such as total AWOLs, vehicle registrations, offenses, apprehensions.

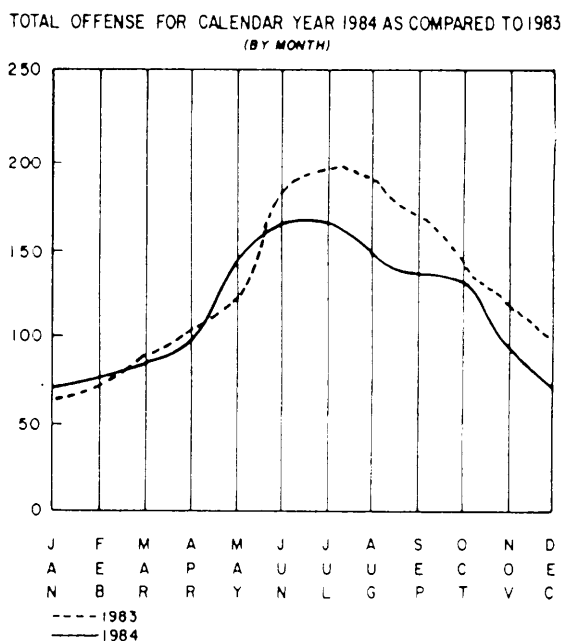

Figure 18-4.-Curve chart.

VERTICAL BAR (COLUMN) CHART.—

Another chart frequently used to depict enforcement data is the vertical bar or column chart (fig. 18-5). This chart is also used to depict numerical values of a given item over a period of time. The chart is simple to construct and readily understood. The vertical bar chart is preferable to the curve chart when a sharper delineation of trend is to be shown.

PIE (SECTOR) CHART.— The circle graph or pie chart (fig. 18-6) compares various components with each other and with the whole. This chart serves to direct attention to extreme areas.

The primary disadvantage of the pie chart is that, if many segments are involved, the chart will appear confusing. The small sections of the chart will be difficult to label in a case of that type. A bar chart is recommended when dealing with many components.

Frequency Distribution Table

The frequency distribution table (fig. 18-7) is considered an essential element of selective enforcement planning. The primary purpose of this table is to show the number and time or place of violations by category. In figure 18-7, the frequency distribution table is used to depict the number of apprehensions and type of offenses committed by personnel in various units during a 1-month period. This table may easily be applied when working with traffic statistics or major crimes.

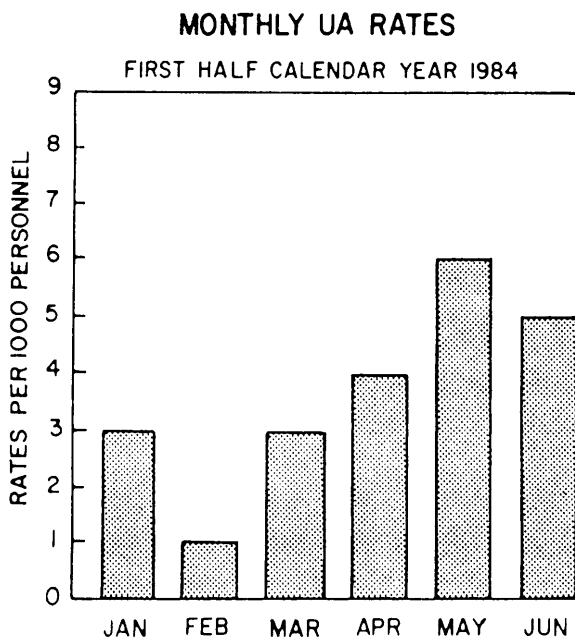

Figure 18-5.—Vertical bar (column) chart.

ALCOHOL FACTOR IN ALL APPREHENSIONS OF MILITARY PERSONNEL

JUNE 1984

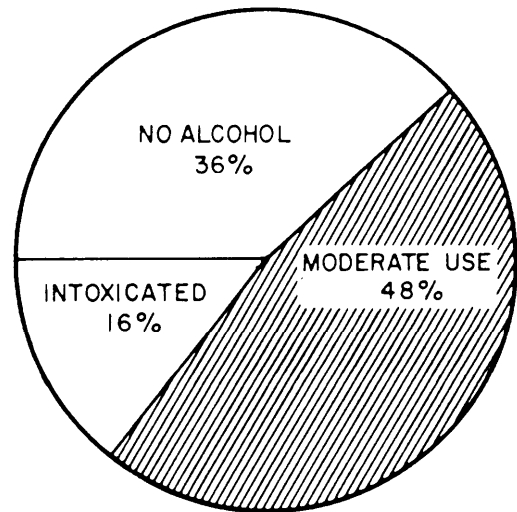

Figure 18-6.—Pie (sector) chart.

Spot Map

The spot map is another way of graphically presenting data pertaining to frequency, type, and location of accidents or incidents. This chart is also considered to be an essential element of selective enforcement planning. A map of an area is mounted on a board capable of holding pins that are stuck into it. Locations of accidents or incidents are indicated by pins stuck into the map at the location where the incidents or accidents occurred. Different types of accidents or incidents (such as injuries or fatalities) maybe depicted by different colored pins or ones with different markings. The spot map may be used as a yearly record and, if photographed, maybe compared with succeeding years.

RECORDS AND FORMS

LEARNING OBJECTIVES: Explain the importance of accurate records and reports. List the generic names and basic uses of the forms employed in Navy law enforcement.

Records and reports within a security department are of great importance in maintaining efficiency. They must be accurate, concise, and complete at all times. They are discussed in this chapter to acquaint personnel newly assigned as MAs with the large amount of legal

THE VARIOUS UNITS WILL BE LISTED IN THIS COLUMN	DRUGS	DRUNK	DRUNK & DISORDERLY	DRUNKEN DRIVING	DISORDERLY CONDUCT	OFF LIMITS	TRAFFIC	NO POST TAGS	UNIFORM VIOLATIONS	VICE	PASS VIOLATIONS	OTHER	TOTAL
	1	1	3				4	1	1			1	12
	1												1
													0
													0
													0
													0
													0
													0
													0
	4	2	3	4	4		23	10	1		2	2	69
		1		4	4		4	1				7	25
	6	5		2	2		17	1				4	31
													1
							1						1
		1		1									2
							3	3				2	8
	25	4	1	2	1		1	1					31
	29	24	7	18	10		56	17	2		2	17	182

Figure 18-7.-Frequency distribution table. Monthly report of apprehensions.

and administrative paper work required to record all facets of law enforcement operations efficiently.

The NCIS has developed a manual for filling out the standard forms used by security departments to be used throughout the Navy called the *Reports and Forms Preparation Guide for the Navy Security Force*. The use and preparation of these forms are also discussed in the *Law Enforcement Manual*, OPNAVINST 5580.1, also developed by NCIS. Some of the most common forms, their generic names, and basic uses are as follows:

- Incident/Complaint Report. Used to record all incidents, complaints, and traffic accidents.
- Voluntary Statement Form. Used when taking a written statement from a complainant, witness, or other interested party other than a suspect.
- Military Suspects Acknowledgment of Rights Form. Used before to an interrogation or when taking a written statement from a military suspect.
- Civilian Suspects Acknowledgment of Rights Form. Used before to an interrogation or when taking a written statement from a civilian suspect.

- **Evidence/Property Custody Document.** Used to record and maintain a chain of custody for evidence and valuables received by a Navy law enforcement activity.

- **Evidence Tag.** Used to mark and identify specific items of evidence.

- **Record of Authorization for Search** (formerly called Affidavit for Search Authorization and Command Authorization for Search and Seizure). Submitted to the commanding officer or other person of authority to authorize a search (a basis for a command-authorized search).

This form, when completed by a person in authority, is your authorization to conduct a search of a specific person or place and to seize specific items.

- **Consent Search** (formerly called Permissive Authorization for Search and Seizure). Used to conduct a search of a person, or that person's property who has given voluntary consent to be searched.

- **Desk Journal** (formerly called a desk blotter). Used to record a chronological record of all incidents, reports, complaints, and so forth. Maintained at a patrol or security headquarters.

- **Interview/Interrogation Log.** Used to record personal data of persons interviewed or interrogated and all pertinent facts of the interview or interrogation.

- **Lineup—Acknowledgement and Waiver of Rights.** Used when a lineup is conducted of a suspect who chooses not to consult with an attorney or have one present during the lineup.

- **Telephonic Threat Complaint.** Used to record and report any bomb threats and or other threatening communications received by telephone. This form should be kept close to the telephones.

- **Traffic Accident Report.** This is a supplement to the Incident/Complaint Report (ICR) and is used in all instances of traffic accidents involving Navy vehicles or on Navy property. An ICR must also be completed with a narrative report of the accident in block 17 of the ICR form.

- **Operator's Report of a Motor Vehicle Accident Report.** This form should be in all Navy-owned vehicles at all times. The driver uses this form to report any accidents involving the Navy vehicle they are driving. This form should be completed at the accident scene, if at all possible.

- **Alcoholic Influence Report.** Used when there is alcohol involvement in incidents and accidents. If an apprehension is made, this form should be completed and listed as an enclosure on page 3 of the ICR.

- **Complaint of Stolen Vehicle.** Used to report the theft of a privately owned motor vehicle from a naval installation. It should be used in conformity with local NCIS policy and procedures.

- **Vehicle Report.** Used to report any situations in which security department personnel take physical possession of a privately owned vehicle (POV), under provisions of chapter 6, OPNAVINST 11200.5.

- **Forensic Examination Report.** Used to transfer evidence to another agency on a temporary basis, normally for laboratory examination purposes. See appendix II.

- **Field Test Results.** Used to report the informal screening test performed on a suspect regarding a controlled substance. Formal laboratory analysis should be conducted if the information is to be used as evidence in court.

- **Customer Consent and Authorization for Access to Financial Information.** Used when an official investigation is being conducted and the investigator or agency requires an individual's financial records. Individuals must be advised of their rights under the Rights to Financial Privacy Act of 1978 prior to signing.

- **Authority to Release Medical Information and Records.** Used to obtain records and information from civilian medical facilities. Individuals must personally sign this form to authorize release of their records.

- **Abandoned Vehicle Notice.** This multicopy form is used to provide written notice to the owner of a POV pending impoundment action by the security department.

- **Abandoned Vehicle Removal Authorization.** This multicopy form is used when the decision is made to tow a POV under provisions of chapter 6, OPNAVINST 11200.5. Normally the removal would be authorized by the security officer, chief of police, or other designated personnel within the security department. Check local standard operating procedures (SOP) for specific guidance.

- **Vehicle Impoundment Report.** This multicopy form is used after a POV has been towed for a violation under the provisions of chapter 6, OPNAVINST

11200.5, as a record of action. This form should be used whether the vehicle was towed by contracted (commercial) tow service or installation's public works center (PWC).

- **Notice of Vehicle Impoundment.** This multicopy form is used to provide written notice to the owner of a vehicle regarding impoundment and possible disposal if the owner fails to take action to reclaim the vehicle.

- **Law Enforcement Communications Log.** This form should be kept by the security department's dispatcher to record all significant radio transmissions during a 24-hour period.

- **Field interview card.** Completed by security force personnel when they make contact with individuals under suspicious circumstances or in unauthorized locations.

OFFICIAL PUBLICATIONS AND DIRECTIVES

LEARNING OBJECTIVES: Explain the importance of proper handling, correcting, and using of official publications. List the publications that are usually maintained by Navy security departments.

Handling, correcting, and using official publications and directives are routine, but important, duties of the MA. Much of the efficiency of any security department depends upon the condition of its official publications and directives, their accessibility, and how well you know how to use them.

You will be expected to identify the various publications by title and by appearance and to have a general idea of the content of each and the procedures to which it is related. If necessary, have a system for checking the publication out to those authorized to use it so you will always be able to locate it. If it is classified or registered, you should follow appropriate instructions for its handling.

Changes and corrections are made by inserting new pages, removing obsolete pages, or making pen-and-ink changes in the existing book. A publication that is not up to date, or one that has been changed incorrectly, is useless, because it can give wrong directions.

When a list of effective pages is included with a change, check all pages against the checklist. This procedure determines whether or not your publication is current.

You will use the various publications and directives increasingly as you learn your job. They are the references to which you will turn for information about correct procedures. In any billet, you need the answers to numerous questions. You cannot possibly remember all these answers and, in fact, you should not try to do so. Instead, you should know where to locate the information. The better you know your official publications and directives, the quicker you will be able to find what you need.

The following publications usually are maintained by Navy Security departments:

- *United States Navy Regulations, 1990*— This publication outlines the organizational structure of the Department of the Navy (DON) and issues the principles and policies by which the Navy is governed. It is published in loose-leaf form and kept in an adjustable binder so changes may be inserted as necessary. The Chief of Naval Operations (CNO) is responsible for making changes as approved by the Secretary of the Navy (SECNAV) to *Navy Regulations*.

- *Manual for Courts-Martial, United States, 1984 (MCM)*— By enacting the UCMJ, Congress established a single set of laws for administering justice to all the armed forces. The *MCM* consists of five parts: Part I—the Preamble; Part II—the Rules for Courts-Martial (R.C.M.); Part III—the Military Rules of Evidence (Mil.R.Evid or M. R.E.); Part IV—the Punitive Articles; and Part V—Nonjudicial Punishment Procedures.

Part II (R.C.M.) governs the procedures and punishments in all courts-martial and, whenever expressly provided, preliminary, supplementary, and appellate procedures and activities. Part III (M.R.E.) is construed to (1) secure fairness in administration, (2) eliminate unjustifiable expense and delay in court-martial proceedings, and (3) promote growth and development of the law of evidence to the end that the truth may be learned and proceedings justly determined. Part IV, the Punitive Articles, addresses all the punitive articles of the UCMJ. Each article includes the text of that particular article, an explanation of the article, the elements of the offense, any lesser included offenses, the maximum punishment for the offense, and a sample specification for the article.

- *Manual of the Judge Advocate General (JAGMAN), JAGINST 5800.7*—The JAGMAN contains regulations for the DON. It is prepared by the Judge Advocate General of the Navy and covers issues such as administrative investigations; Article 138 complaints; Article 139 investigations; release of

government information; delivery of service members; service of process and subpoenas; authority of armed forces personnel to perform notarial acts; legal assistance; claims regulations; international law; customs requirements; admiralty claims; environmental protection; and payments due mentally incompetent members, physical examinations of such members, and trustee designations.

- *The United States Navy Uniform Regulations*— This publication is prepared and distributed by the Chief of Naval Personnel. It describes and lists the various uniforms for personnel in all categories, lists the uniforms required, and contains lists of articles worn or used together. It also describes occasions when the various uniforms should be worn; methods of wearing medals, decorations, ribbons, rating badges, and special markings; and gives notes on the care of the uniform. Changes are issued by the Commander, Bureau of Naval Personnel as changes in uniforms occur.

- *The Department of the Navy Correspondence Manual*, SECNAVINST 5216.5—This manual is prepared and approved in the Office of the Secretary of the Navy. It contains instructions for preparing letters, endorsements, memorandums, and messages. Instructions cover all parts of correspondence such as address, subject, references, paragraphing, and signature, together with directions for assembling correspondence for signature and mailing.

- *Standard Organization and Regulations of the U.S. Navy (SORM)*, OPNAVINST 3120.32. This publication is issued by CNO. It issues regulations and guidance governing the conduct of all members of the U.S. Navy. These regulations use two types of print—the material printed in uppercase is regulatory, and the material printed in plain type is for the guidance of commanders, commanding officers (COs), and officers in charge (OICs). These regulations apply to each member of the Navy individually. Violation of any provision of these regulations is punishable under the UCMJ.

- *Department of the Navy Information and Personnel Security Program Regulation*, OPNAVINST 5510.1— This publication is issued by CNO and is commonly referred to as the *Security Manual*. Its provisions apply to DON military and civilian personnel and activities. The *Security Manual* provides personnel with regulations and guidance for classifying and safeguarding classified information and for personnel security.

- *Standard Navy Distribution List (SNDL)*— The SNDL is published by the CNO and provides for the proper addressing and distribution of mail to all activities of the DON and provides a central distribution system for directives and correspondence. The SNDL is published in two parts, and each part is issued separately. Part 1 is often referred to as the yellow pages and is entitled *Standard Navy Distribution List, Operating Forces of the Navy, Unified and Specified Commands, U.S. Elements of International Communal*, OPNAVINST P09B2-107. The SNDL listings are identified by a two-digit number for each major group followed by one or more letters for each subgroup. Part 2 of the SNDL, contained in the publication *Catalog of Naval Shore Activities*, OPNAVINST P09B2-105, provides distribution lists for the Navy Department and all shore activities of the Naval Establishment. Each symbol represents a type of naval activity.

Revisions and changes to the SNDL are issued periodically, normally on a quarterly basis, by CNO. When issued, changes are of two types: page changes in the form of a supplement and serial changes. The supplements are sent to all commands, but serial changes are provided only to commands handling large volumes of mail that require up-to-date information.

- *United States Navy Physical Security and Loss Prevention Instruction*, OPNAVINST 5530.14. This instruction is prepared and distributed by the Office of Chief of Naval Operations. It establishes policy, provides guidance, and sets forth uniform standards for security measures to physically safeguard Navy property and material at Navy shore activities. This instruction was formerly known as the *Physical Security Manual*.

- *Corrections Manual*. This manual is prepared and distributed by the Office of the Secretary of the Navy. It sets forth the basic policies, standards, and procedures for the operation of Navy confinement facilities.

- *Navy Law Enforcement Manual*. Developed by NCIS, this will be one of your more important references as it will provide policy guidance and standardize procedures for Navy law enforcement activities.

- *Flags, Pennants, and Customs*, NTP 13, and *U.S. Navy Regulations*, chapter 12. These two sources contain complete information concerning honors and ceremonies.

- **Other manuals.** Certain commands have manuals dealing with technical subjects involved in their respective functions. If you are assigned to a department where one of these manuals is used, you should become acquainted with the format and general content.

SUMMARY

In this chapter, we looked at the organization structure of Navy law enforcement units and the

planning necessary for a Navy law enforcement operation. Work simplification was also discussed and several techniques for improving work methods were pointed out. Next, we considered crime prevention and the crime prevention survey. In the section on statistics, we examined how an accurate compilation of statistical data can help in the law enforcement effort. The most common forms and records used by Navy law enforcement were covered next, followed by the official publications and directives that are usually maintained by security departments.

APPENDIX I

GLOSSARY OF TERMS IN LAW

The following words and phrases are those most frequently encountered in law by Masters-at-Arms and have special legal connotations. The list is by no means complete, nor is it intended as a substitute for an up-to-date law dictionary. Further, this glossary is designed solely as a ready reference for the meaning of certain terms. Where it has been necessary to explain a word or phrase in the language of or in relation to a rule of law, no attempt has been made to set forth a definitive or comprehensive statement of such rule of law.

ABANDONED PROPERTY— Property to which the owner has relinquished all rights, title, claims, and possession with intention of not reclaiming it or resuming ownership, possession, or enjoyment.

ABET— To encourage, incite, or set another on to commit a crime, Article 77, UCMJ.

ACCESSORY AFTER THE FACT— Any person subject to the Code who, knowing that an offense punishable by the Code has been committed, receives, comforts, or assists the offender in order to hinder or prevent the offender's apprehension, trial, or punishment. NOTE: Article 78, UCMJ, deals with accessories.

ACCESSORY BEFORE THE FACT— One who counsels, commands, procures, or causes another to commit an offense—whether present or absent at the commission of the offense. NOTE: Under Article 77, UCMJ, an accessory before the fact is a principal.

ACCUSATION— A formal charge against a person, to the effect that the person is guilty of a punishable offense, laid before a court having jurisdiction to inquire into the alleged crime.

ACCUSED— One who is charged with an offense under the Code.

ACCUSER— Any person who signs and swears to charges; any person who directs that charges normally be signed and sworn to by another; and any other person who has an interest other than an official interest in the prosecution of the accused.

ACQUITTAL— The legal and formal certification of the innocence of a person who has been charged with a crime; a deliverance or setting free a person from a charge of guilt.

ACTIVE DUTY— The status of being in the active federal service of any of the armed forces under a competent appointment or enlistment or pursuant to a competent muster, order, call, or induction.

ACTUAL KNOWLEDGE— A state wherein the person in fact knows of the existence of an order, regulation, fact, and so forth, in question.

ADDITIONAL CHARGES— New and separate charges preferred after others have been preferred against the accused while the original charges are still pending.

ADJOURNMENT— The putting off or postponing of a trial until a stated time or indefinitely; a cessation of the proceedings for a period extending beyond the same day.

ADJUDICATE— To determine whether a claim is proper and decide what amount, if any, should be paid the claimant.

ADMINISTRATIVE BOARD— A board appointed to render findings based on facts pertaining, or believed to pertain, in a case and to recommend retention, separation, or suspension of separation, and the reason for separation and the characterization of service or description of separation.

ADMINISTRATIVE SEPARATION— A discharge or release from active duty upon expiration of enlistment or required period of service, or before, by administrative means and not by a court-martial.

ADMIRALTY— That body of law and regulation dealing with civil maritime cases.

ADMISSION— A self-incriminatory statement falling short of a complete acknowledgement of guilt.

- AD VALOREM**— “According to value.” Ad valorem tax is a tax or duty upon the value of the article or thing subject to taxation.
- AFFIANT**— The person who makes and subscribes an affidavit.
- AFFIDAVIT**— A statement or declaration reduced to writing and confirmed by the party making it by an oath taken before a person who has authority to administer the oath.
- AGENT**— A person authorized by another to act for that person. One entrusted with another’s business.
- AIDER AND ABETTOR**— One who shares the criminal intent or purpose of a perpetrator, and hence is liable as a principal, Article 77, UCMJ.
- ALIBI**— A defense that the accused could not have committed the offense alleged because the accused was somewhere else when the crime was committed.
- ALLEGATION**— The assertion, declaration, or statement of a party in a pleading of what the party expects to prove.
- ALLEGE**— To assert or state in a pleading; to plead in a specification.
- APPEAL**— A complaint to a superior court of an injustice done or error committed by an inferior court whose judgment or decision the court above is called upon to correct or reverse. See Appellate Review.
- APPELLANT**— The party who takes an appeal from one court or jurisdiction to another.
- APPELLATE REVIEW**— The examination of the records of cases tried by courts—martial by proper reviewing authorities, including, in appropriate cases, the convening authority, the Court of Military Review, the Court of Military Appeals, the U.S. Supreme Court, and the Judge Advocate General.
- APPREHENSION**— The taking of a person into custody.
- APPROVED FINDINGS OF AN ADMINISTRATIVE BOARD**— Final approval of the findings of an administrative board rests with the separation authority and, unless the separation authority modifies the findings and recommendation, approval of the boards recommendations as to characterization or separation, or both, constitutes approval of such findings and recommendations.
- ARBITRATION**— The act of determining a decision in a controversy by a disinterested third party.
- ARRAIGNMENT**— The reading of the charges and specification to the accused or the waiver of their reading, coupled with the request that the accused plead thereto.
- ARREST**— Moral restraint imposed upon a person by oral or written orders of competent authority limiting the person’s personal liberty pending disposition of charges. Arrest is not imposed as punishment for an offense.
- ARREST IN QUARTERS**— A moral restraint limiting an officer’s liberty, imposed as a nonjudicial punishment by a flag or general officer in command.
- ARTICLE 15**— The Article of the UCMJ that grants the power of a commander to impose nonjudicial punishment.
- ARTICLE 32 INVESTIGATION**— See Pretrial Investigation.
- ARTICLE 39a SESSION**— A session of a court-martial called by the military judge, either before or after assembly of the court, without the members of the court being present, to dispose of matters not amounting to a trial of the accused’s guilt or innocence.
- ASPORTATION**— A carrying away; felonious removal of goods; refers to one of the ways in which larceny under Article 121, UCMJ, maybe committed.
- ASSAULT**— An attempt or offer with unlawful force or violence to do bodily harm to another, whether or not the attempt or offer is consummated, Article 128, UCMJ.
- ASSEMBLED**— A court is said to be assembled when its preliminary organization is complete, the members have gathered in the courtroom, and the presiding officer announces the court assembled.
- ATTEMPT**— An act, or acts, done with a specific intent to commit an offense under the Code, amounting to more than mere preparation, and tending but failing to effect the commission of such offense.
- ATTEST**— To signify by subscription of the signer’s name that the signer has witnessed the execution of the particular instrument.
- ATTORNEY, POWER OF**— An instrument authorizing another to act as one’s agent or attorney. The instrument by which authority of one person to

- act in place and stead of another as attorney in fact is set forth.
- AUTHENTICATION**— An official statement certifying that a writing is true and accurate.
- AUTHENTICITY**— The quality of being genuine in character, which in the law of evidence refers to a piece of evidence actually being what it purports to be.
- BAD-CONDUCT DISCHARGE**— One of two types of punitive discharges that may be awarded an enlisted member as a court-martial sentence; designed as a punishment for bad conduct, rather than as a punishment for serious offenses of either a civil or military nature; may be awarded by GCM or SPCM.
- BAIL**— To procure the release of a person from legal custody, by undertaking that the person will appear at the time and place designated and submit to the jurisdiction and judgment of the court.
- BATTERY**— An assault in which the attempt or offer to do bodily harm is consummated by the infliction of that harm, Article 128, UCMJ.
- BEYOND A REASONABLE DOUBT**— The degree of persuasion based upon proof such as to exclude not every hypothesis or possibility of innocence, but any fair and rational hypothesis except that of guilt; not an absolute or mathematical certainty but a moral certainty.
- BIGAMY**— The criminal offense of willfully and knowingly contracting a second marriage (or going through the form of a second marriage) while the first marriage, to the knowledge of the offender, is still substituting and undissolved.
- BODILY HARM**— Any physical injury to or offensive touching of the person of another, however slight.
- BONA FIDE**— In good faith; actual; genuine.
- BREACH OF ARREST**— Going beyond the limits of arrest as set by orders, Article 95, UCMJ.
- BREACH OF PEACE**— An unlawful disturbance of the peace by an outward demonstration of a violent or turbulent nature, Article 116, UCMJ.
- BREAKING ARREST**— Going beyond the limits of arrest before being released by proper authority.
- BURGLARY**— The breaking and entering in the nighttime of the dwelling of another with intent to commit murder, manslaughter, rape, carnal knowledge, larceny, wrongful appropriation, robbery, forgery, maiming, sodomy, arson, extortion, or assault, Article 129, UCMJ.
- BUSINESS ENTRY**— Any writing or record, whether in the form of an entry in a book or otherwise, made as a memorandum or record of any act, transaction, occurrence, or event, made in the regular course of any business, profession occupation, or calling of any kind
- CAPITAL OFFENSE**— An offense for which the maximum punishment includes the death penalty.
- CAPTAIN'S MAST**— The term applied, through tradition and usage in the Navy and Coast Guard, to nonjudicial punishment proceedings.
- CARNAL KNOWLEDGE**— An act of sexual intercourse under circumstances not amounting to rape, by a person with a female who is not his wife, and who has not attained the age of 16, Article 120, UCMJ.
- CASE LAW**— Law obtained from cases that have been decided.
- CAVEAT EMPTOR**— “Let the buyer beware (or take care).”
- CHALLENGE**— A formal objection to a member of a court or the military judge continuing as such in subsequent proceedings. May be either (1) a challenge for cause—such objections based on a fact or circumstance that has the effect of disqualifying the person challenged from further participation in the proceedings or (2) peremptory challenge—such objection is permitted without grounds or basis, except that the military judge cannot be peremptorily challenged
- CHANGE OF VENUE**— Removal of a trial from one jurisdiction to another.
- CHARGE**— A formal statement of the Article of the UCMJ that the accused is alleged to have violated.
- CHARGE AND SPECIFICATION**— A description in writing of the offense that the accused is alleged to have committed; each specification, together with the charge under which it is placed, constitutes a separate accusation.
- CHARGE SHEET**— A two-page document, DD Form 58, that contains (1) information about the accused (2) the charges and specifications, (3) the preferring of charges and their referral to a summary, special, or general court-martial, and (4) in the case of a summary court-martial, the record of trial.

CHIEF WARRANT OFFICER— A warrant officer of the armed forces who holds a commission or warrant in warrant officer grades W-2 through W-4

CIRCUMSTANTIAL EVIDENCE— Testimony not based on actual personal knowledge or observation of the facts in controversy, but of other facts from which deductions are drawn, showing indirectly the facts sought to be proved.

CLEMENCY— Discretionary action by proper authority to reduce the severity of a punishment.

CLOSED SESSIONS— Those periods during a court-martial where the members or the military judge (in a judge alone case) is deliberating alone on findings and sentence.

CODIFICATION— Process of collecting and arranging the laws of a country or state into a code; for example, *U.S. Code*.

COLLATERAL ATTACK— An attempt to impeach or challenge the integrity of a court judgment in a proceeding other than that in which the judgment was rendered and outside the normal chain of appellate review.

COLLISION— Striking together of two objects, one of which may be stationary. The act of ships or vessels striking together. In its strict sense, collision means the impact of two vessels, both moving, and is distinguished from allision, which designates the striking of a moving vessel against one that is stationary.

COMMAND— (1) An order; (2) any demanding of another to do an act toward commission of a crime, Article 77, UCMJ.

COMMANDING OFFICER— A commissioned officer in command of a unit or units, an organization, or an area of the armed forces.

COMMISSIONED OFFICER— An officer of the naval service who holds a commission in an officer grade, chief warrant officer W-2, and above.

COMMON TRIAL— A trial in which two or more persons are charged with the commission of an offense or offenses that, although not jointly committed, were committed at the same time and place and are provable by the same evidence.

COMPETENCY— The presence of those characteristics, or the absence of those disabilities (for example, exclusionary rules), that renders a particular item of evidence fit and qualified to be presented in court.

CONCURRENT JURISDICTION— Jurisdiction that is possessed over the same parties or subject matter at the same time by two or more separate tribunals.

CONCURRENT SERVICE OF PUNISHMENT— Two or more punishments being served at the same time.

CONFESSION— An acknowledgement of guilt of an offense.

CONFINEMENT— The physical restraint of a person, imposed by either oral or written orders of competent authority, depriving a person of freedom.

CONSECUTIVE SERVICE OF PUNISHMENT— Two or more punishments being served in series, one after the other.

CONSPIRACY— A combination of two or more persons who have agreed to accomplish, by concerted action, an unlawful purpose or some purpose not in itself unlawful but by unlawful means, and the doing of some act by one or more of the conspirators to effect the object of that agreement.

CONSTRUCTIVE ENLISTMENT— A valid enlistment arising where the initial enlistment was void but the enlistee submits voluntarily to military authority, is mentally competent and at least 17 years old, receives pay, and performs duties.

CONSTRUCTIVE KNOWLEDGE— A state wherein a person is inferred to have knowledge of an order, regulation, or fact as a result of having a reasonable opportunity to gain such knowledge (for example, presence in an area where the relevant information was commonly available).

CONTEMPT— In military law, the use of any menacing words, signs, or gestures in the presence of the court, or the disturbance of its proceedings by any riot or disorder.

CONTINUANCE— The adjournment or postponement of a case to another day or time.

CONTRABAND— Items the possession of which is in and of itself illegal.

CONVENING AUTHORITY— The officer having authority to convene a court-martial and who convened the court-martial in question, or that officer's successor in command.

CONVENING ORDER— The document by which a court-martial is created, specifies the type of court,

details the members, and, when appropriate, the specific authority by which the court is created.

CORPUS DELICTI— “The body of a crime.” Facts or circumstances showing that the crime alleged has been committed by someone.

COUNSELING— Directly or indirectly advising or encouraging another to commit an offense, Article 77, UCMJ.

COURT-MARTIAL— military court convened under authority of the government and the UCMJ for trying and punishing offenses committed by members of the armed forces and other persons subject to military law.

COURT-MARTIAL ORDER— A published order announcing the results of a court-martial trial.

COURT OF INQUIRY— A formal administrative fact-finding body convened under the authority of Article 135, UCMJ, whose function is to search out, develop, analyze, and record all available information relative to the matter under investigation.

COURT OF MILITARY APPEALS— The highest appellate court established under the UCMJ to review the records of certain trials by court-martial, consisting of three judges appointed from civil life by the President, by and with the advice and consent of the Senate, for a term of 15 years.

COURT OF MILITARY REVIEW— An intermediate appellate court established by each Judge Advocate General to review the record of certain trials by court-martial-formerly known as Board of Review.

CREDIBILITY OF A WITNESS— A witness’ worthiness of belief.

CROSS-EXAMINATION— The examination of a witness at a trial or hearing, or at a deposition, by the party opposed to the one who produced him or her, upon his or her evidence given in the case-in-chief, to test its truth, to further develop it, or for other purposes.

CULPABLE— Deserving blame; involving the breach of a legal duty or the commission of a fault.

CULPABLE NEGLIGENCE— Culpable negligence is a degree of negligence greater than simple negligence. This form of negligence is also referred to as recklessness and arises whenever an accused recognizes a substantial unreasonable risk yet consciously disregards that risk.

CUSTODY— That restraint of free movement that is imposed by lawful apprehension.

CUSTOM— A practice that fulfills the following conditions: (a) it must be long continued; (b) it must be certain or uniform; (c) it must be compulsory; (d) it must be consistent; (e) it must be general; (f) it must be known; and (g) it must not be in opposition to the terms and provisions of a statute or lawful regulation or order.

DAMAGE— Any physical injury to property.

DANGEROUS WEAPON— A weapon used in such a manner that it is likely to produce death or grievous bodily harm.

DECEIVE— To mislead, trick, cheat, or to cause one to believe as true that which is false.

DEFENSE COUNSEL— The person who defends the accused in any proceeding.

DEFERRAL— Discretionary action by proper authority, postponing the running of the confinement portion of a sentence, together with a lack of any posttrial restraint.

DEFRAUD— To obtain, through misrepresentation, an article or thing of value and to apply it to one’s own benefit or to the use and benefit of another-either permanently or temporarily.

DEMONSTRATIVE EVIDENCE—Anything such as charts, maps, photographs, models, and drawings used to help construct a mental picture of a location or object that is not readily available for introduction into evidence.

DEPOSITION— The testimony of a witness taken out of court, reduced to writing, under oath or affirmation, before a person empowered to administer oaths, in answer to interrogatories (questions) and cross-interrogatories submitted by the parties desiring the deposition and the opposite party, or based on oral examination by counsel for the accused and the prosecution.

DERELICTION IN THE PERFORMANCE OF DUTIES— Willfully or negligently failing to perform assigned duties or performing them in a culpably inefficient manner.

DESIGN— On purpose, intentionally, or according to plan and not merely through carelessness or by accident; specifically intended.

DESTROY— Sufficient injury to render property useless for the purpose that it was intended, not necessarily amounting to complete demolition or annihilation.

DETENTION OF PAY— A less severe form of punishment than a forfeiture in that the amount detained is ultimately returned to the accused when the accused is separated from service, or within a specific period of 1 year or less.

DIRECT EVIDENCE— Evidence that tends directly to prove or disprove a fact in issue.

DISCHARGE— Complete severance from all naval status gained by the enlistment or induction concerned.

DISCOVERY— The right to examine information possessed by the opposing side before or during trial.

DISHONORABLE DISCHARGE— The most severe punitive discharge; reserved for those warrant officers (W-1) and enlisted members who should be separated under conditions of dishonor, after having been convicted of serious offenses of a civil or military nature warranting severe punishment; it may be awarded only by a GCM.

DISMISSAL— A court-martial punishment of separation from the service with dishonor. Only officers, commissioned warrant officers, cadets, and midshipmen may receive a dismissal, and it can only be awarded by a GCM. It is considered the equivalent of a dishonorable discharge.

DISORDERLY CONDUCT— Behavior of such a nature as to affect the peace time quiet of persons who may witness the same and who may be disturbed or provoked to resentment thereby.

DISRESPECT— Words, acts, or omissions that are synonymous with contempt and amount to behavior or language that detracts from the respect due the authority and person of a superior.

DOCUMENTARY EVIDENCE— Evidence supplied by writings and documents.

DOMINION— Control of property; possession of property with the ability to exercise control over it.

DRUNKENNESS— (1) As an offense under the UCMJ, intoxication that is sufficient sensibly to impair the rational and full exercise of the mental and physical Faculties that may be caused by liquor or drugs; (2) as a defense in rebuttal of the existence of a criminal element involving premeditation, specific intent, or knowledge, intoxication that amounts to a loss of

reason preventing the accused from harboring the requisite premeditation, specific intent, or knowledge; (3) as a defense to general intent offenses, involuntary intoxication that amounts to a loss of reason preventing the accused from knowing the nature of his or her act or the natural and probable consequence thereof.

DUE PROCESS— A course of legal proceedings according to those rules and principles that have been established in our system of jurisprudence for the enforcement and protection of private rights; such an exercise of the powers of the government as the settled maxims of law permit and sanction, and under such safeguards for the protection of individual rights as those maxims prescribe.

DURESS— Unlawful constraint on a person whereby the person is forced to do some act that he or she otherwise would not have done.

DYING DECLARATION— A statement by a victim, concerning the circumstances surrounding his or her death, made while in extremis and while under a sense of impending death and without hope of recovery.

ELEMENTS— The essential ingredients of an offense that are to be proved at the trial; the acts or omissions that form the basis of any particular offense.

ENTRAPMENT— A defense available when actions of an agent of the government intentionally instill in the mind of the accused a disposition to commit a criminal offense, when the accused has no notion, predisposition, or intent to commit the offense.

ENTRY LEVEL STATUS— Upon enlistment, a member qualifies for entry level status during either (1) the first 180 days of continuous active military service or (2) the first 180 days of continuous active service after a break of more than 92 days of active service. A member of a Reserve component who is not on active duty or who is serving under a call or order to active duty for 180 days or less begins entry level status upon enlistment in a Reserve component.

ERROR— A failure to comply with the law in some way at some stage of the proceedings.

EVIDENCE— Any species of proof, or probative matter, legally presented at trial, through the medium of witnesses, records, documents, concrete objects, demonstrations, and so forth, for the purpose of inducing belief in the minds of the triers of fact.

EXCLUSIONARY RULES— This rule commands that where evidence has been obtained in violation of the search and seizure protections guaranteed by the U.S. Constitution, the illegally obtained evidence cannot be used at the trial of the defendant.

EXCULPATORY— Anything that would exonerate a person of wrongdoing.

EXECUTION OF HIS OR HER OFFICE— Engaging in any act or service required or authorized to be done by statute, regulation, or the order of a Superior.

EXONERAT— To clear from alleged fault or guilt.

EX POST FACTO LAW— A law passed after the occurrence of a fact or commission of an act that makes the act punishable, imposes additional punishment, or changes the rules of evidence to the disadvantage of a party.

EXTENUATION— Information that renders a crime less heinous than it would be without it and is presented in an effort to lessen the punishment that could be awarded at a court-martial or a nonjudicial punishment proceeding.

EXTRA MILITARY INSTRUCTION— Extra tasks assigned to one exhibiting behavioral or performance deficiencies for the purpose of correcting those deficiencies through the performance of the assigned tasks; also known as additional military duty or additional military instruction.

EXTREMIS— In extreme danger or need.

FEIGN— To misrepresent by a false appearance or statement; to pretend, to simulate, or to falsify.

FINDINGS— The determination of the issue as to whether an accused is guilty or innocent.

FINE— A type of court-martial punishment in the nature of a pecuniary judgment against an accused, which, when ordered executed, makes him or her immediately liable to the United States for the entire amount of money specified.

FORFEITURE OF PAY— A type of court-martial or nonjudicial punishment depriving the accused of all or part of the accused's pay.

FORMER JEOPARDY— A defense in bar of trial that no person will be tried for the same offense by the same sovereign a second time without his or her consent; also known as double jeopardy.

FORMER PUNISHMENT— A defense in bar of trial that no person may be tried by court-martial for a minor offense for which punishment under Article 15, UCMJ, has been imposed.

FORMER TESTIMONY— Testimony of a witness given in a civil or military court at a former trial of the accused, or given at a formal pretrial investigation of an allegation against the accused, in which the issues were substantially the same.

FRISK— Contact of the outer clothing of a person to detect by the sense of touch whether a concealed weapon is being carried.

GENERAL COURT-MARTIAL— The highest trial court within the military judicial system.

GENERAL DISCHARGE— An administrative discharge given to military personnel who do not qualify for an honorable discharge.

GRANT OF IMMUNITY— A promise of immunity from prosecution in return for courtroom testimony.

GRIEVOUS BODILY HARM— A serious bodily injury; does not include minor injuries, such as a black eye or a bloody nose, but does include fractured or dislocated bones, deep cuts, torn members of the body, serious damage to internal organs, and other serious bodily injuries.

GROSS NEGLIGENCE— A wanton, careless, and reckless disregard of the rights and safety of others; an utter indifference to the consequences of one's actions; a total abandonment of the standard of reasonable care coupled with a wanton disregard for the safety of others; that degree of negligence that is substantially higher in magnitude than simple inadvertence, but falls short of intentional wrong.

HABEAS CORPUS— "You have the body." An order from a court of competent jurisdiction that requires the custodian of a prisoner to appear before the court to show cause why the prisoner is confined or detained.

HARMLESS ERROR— An error of law that does not materially prejudice the substantial rights of the accused.

HEARSAY— An assertive statement, or conduct, that is offered in evidence to prove the truth of the assertion, but that was not made by the declarant while a witness before the court in the hearing in which it is offered.

IMPROVIDENT PLEA— A plea of guilty that cannot be accepted if (1) the presiding officer is not

satisfied that the accused understands the meaning and effect of his or her pleas, or (2) the elements of the offense have not been admitted, or (3) the accused is not convinced of his or her own guilt.

INCAPACITATION— The physical state of being unfit or unable to perform properly.

INCONTINENCE— (1) Want of chastity; Indulgence in unlawful carnal connection; (2) Unrestrained; uncontrolled; incapable of holding back; (3) Incapable of controlling the excretory functions.

INCULPATORY— Anything that implicates a person in a wrongdoing.

INDECENT— An offense to common propriety; offending against modesty or delicacy; grossly vulgar or obscene.

INDIVIDUAL MILITARY COUNSEL— Counsel requested specifically by the accused or respondent to represent them before a court-martial or administrative board instead of the appointed counsel.

INFERENCE— A fact deduced from another fact or facts shown by the state of the evidence.

INFORMANT— A person who has furnished information resulting in an investigation of a possible violation of law to a person whose official duties include the discovery, investigation, or prosecution of a case.

IN LOCO PARENTIS— “in place of a parent.” Used to signify that a person other than the parent exercises rights and responsibilities over a child.

INSANITY— See Mental Capacity and Mental Responsibility.

INSPECTION— An official examination of persons or property to determine the fitness or readiness of a person, organization, or equipment, not made with a view to any criminal action.

INTENTIONALLY— Deliberately and on purpose; through design, or according to plan, and not merely through carelessness or by accident.

INTERROGATION— In criminal law, the process of questions propounded by police to persons arrested or suspected to seek solutions of crime.

IPSO FACTO— “By the very fact itself.”

JOINT OFFENSE— An offense committed by two or more persons acting together in pursuance of a common intent.

JOINT TRIAL— The trial of two or more persons charged with committing a joint offense.

JURISDICTION— The power of a court to hear and decide a case and to award any appropriate punishment.

KNOWINGLY— With knowledge; consciously, intelligently.

LASCIVIOUS— Tending to excite lust; obscene; relating to sexual impurity; tending to deprave the morals with respect to sexual relations.

LEGAL ADVISOR— A lawyer, uniformed or civilian, under the professional supervision of either the Judge Advocate General or General Counsel of the Navy, certified under or otherwise meeting the professional requirements of Article 27(b), UCMJ.

LESSER INCLUDED OFFENSE— An offense necessarily included in the offense charged; an offense containing some but not all of the elements of the offense charged, so that if one or more of the elements of the offense charged are not proved, the evidence may still support a finding of guilty of the included offense.

LEWD— Lustful or lecherous; incontinence carried on in a wanton manner.

MATTER IN AGGRAVATION— by circumstance attending the commission of a crime that increases its enormity.

MATTER IN EXTENUATION— Any circumstance serving to explain the commission of the offense, including the reasons that actuated the accused but not extending to a legal justification.

MATTER IN MITIGATION— Any circumstance having for its purpose the lessening of the punishment to be awarded by the court and the furnishing of grounds for a recommendation for clemency.

MENTAL CAPACITY— The ability of the accused at the time of trial to understand the nature of the proceedings against him or her and to conduct or cooperate intelligently in his or her defense.

MENTAL RESPONSIBILITY— The ability of the accused at the time of the commission of an offense to appreciate the nature and quality of the wrongfulness of his or her acts.

MILITARY DUE PROCESS— Due process under protections and rights granted military personnel by the *Constitution* or laws enacted by Congress.

MILITARY JUDGE— A commissioned officer, certified as such by the respective Judge Advocates General, who presides over all open sessions of the court-martial to which he or she is detailed.

MILITARY RECORD— An individual's overall performance record while a member of the naval and military services of the United States including personal conduct.

MINOR OFFENSE— An offense for which confinement for less than 1 year is authorized; generally it is also misconduct not involving moral turpitude or any greater degree of criminality than is involved in the average offense tried by summary court-martial.

MISTRIAL— Discretionary action of the military judge, or the president of a special court-martial without a military judge, in withdrawing the charges from the court where such action appears necessary in the interest of justice because of circumstances arising during the proceedings that cast substantial doubt upon the fairness of the trial.

MITIGATION— Action by proper authority reducing punishment awarded at NJP or by court-martial.

MORAL TURPITUDE— An act of baseness, vileness, or depravity in private or social duties, which a man owes to fellowmen or to society in general, contrary to the accepted and customary rule of right and duty between man and man.

MOTION TO DISMISS— A motion raising any defense or objection in bar of trial.

MOTION TO GRANT APPROPRIATE RELIEF— A motion to cure a defect of form or substance that impedes the accused in properly preparing for trial or conducting his or her defense.

MOTION TO SEVER— A motion by one or more to two co-accused that they be tried separately from the other or others.

NAVET— A prior service veteran whose last tour of active duty or active duty for training was in the USN or USNR, who has been discharged or released for more than 2 hours, and who has completed a minimum of 180 consecutive days of active duty.

NEGLECT— Omission or failure to do an act or perform a duty due to want of due care or attention.

NEGLIGENCE— Unintentional conduct that falls below the standards established by law for the protection of others against unreasonable risk of

harm. The failure of a person to exercise the care that a reasonably prudent person would exercise under similar circumstances; something that a reasonable person, guided by those ordinary considerations that ordinarily regulate human affairs, would or would not do.

NONJUDICIAL PUNISHMENT— Punishment imposed under Article 15, UCMJ, for minor offenses, without the intervention of a court-martial.

NONPUNITIVE MEASURES— Those leadership techniques, not a form of informal punishment, that may be used to further the efficiency of a command

OATH— A formal external pledge, coupled with an appeal to the Supreme Being, that the truth will be stated

OBJECTION— A declaration to the effect that the particular matter or thing under consideration is not done or admitted with the consent of the opposing party, but is by him or her considered improper or illegal, and referring the question of its propriety or legality to the court.

OFFICE HOURS— The term applied through tradition and usage in the Marine Corps to nonjudicial punishment.

OFFICER— Any commissioned or warrant officer of the armed forces, warrant officer W-1, and above.

OFFICER IN CHARGE— A member of the armed forces designated as such by appropriate authority.

OFFICIAL RECORD— A writing made as a record of a fact or event, whether the writing is in a regular series of records or consists of a report, finding, or certificate, and made by any person within the scope of his or her official duties provided those duties include a duty to know, or to ascertain through appropriate and trustworthy channels of information, the truth of the fact or event, and to record such fact or event.

ON DUTY— (As used in UCMJ, Article 112). In the exercise of duties of routine or detail, in garrison, at a station, or in the field; does not relate to those periods when, no duty being required of military personnel by order of regulations, they occupy the status of leisure known as "off duty" or "on liberty."

OPINION OF THE COURT— A statement by a court of the decision reached in a particular case, expounding the law as applied to the case, and detailing the reasons upon which the decision is based.

ORAL EVIDENCE— The sworn testimony of a witness received at trial.

OSVET— A prior service veteran whose last tour of active duty was in a branch of service other than Navy, has been discharged or released more than 2 hours, and has completed a minimum of 180 consecutive days' active duty.

PAST RECOLLECTION RECORDED— Memorandum prepared by a witness, or read by him or her and found to be correct, reciting facts or events that represent his or her past knowledge possessed at a time when his or her recollection was reasonably fresh as to the facts or events recorded.

PER CURIAM— "By the court." A phrase used in the report of the opinion of a court to distinguish an opinion of the whole court from an opinion written by any one judge.

PER SE— Taken alone; in and of itself; inherently.

PERPETRATOR— One who actually commits the crime, either by his or her own hand, by an animate or inanimate agency, or by an innocent agent.

PLEADING— The written formal indictment by which an accused is charged with an offense; in military law, the charges and specifications.

PLEAS— The accused's response to each charge and specification.

POSSESSION— Actual physical control and custody over an item of property.

PREFERRAL OF CHARGES— The formal accusation against an accused by an accuser signing and swearing to the charges and specifications.

PREJUDICIAL ERROR— An error of law that materially affects the substantial rights of the accused and requiring corrective action.

PRELIMINARY INQUIRY— The initial investigation of a reported or suspected violation of the UCMJ.

PRESIDENT OF A COURT-MARTIAL— The detailed senior member in rank present at the trial.

PRESIDING OFFICER— In a special court-martial without a military judge, it is the president of the court; in a court-martial with a military judge, the presiding officer is the military judge.

PRESUMPTION— A fact that the law requires the court to deduce from another fact or facts shown by the state of the evidence unless that fact is overcome by other evidence before the court.

PRETRIAL AGREEMENT— An agreement offering the accused to plead guilty to one or more specifications in exchange for a limit on some type of punishment.

PRETRIAL INVESTIGATION— An investigation pursuant to Article 32, UCMJ, that is required before convening a GCM, unless waived by the accused.

PRIMA FACIE CASE— Introduction of substantial evidence that, together with all proper inferences to be drawn therefrom and all applicable presumptions, reasonably tends to establish every essential element of an offense charged or included in any specification.

PRINCIPAL— (1) One who aids, abets, counsels, commands, or procures another to commit an offense that is subsequently perpetrated in consequence of such counsel, command, or procuring, whether the individual is present or absent at the commission of the offense; (2) the perpetrator.

PRIOR ENLISTMENT OR PERIOD OF SERVICE— Service in any component of the armed forces, including the Coast Guard, that culminated in the issuance of a discharge certificate or certificate of service.

PROBABLE CAUSE— (1) For apprehension, a reasonable grounds for believing that an offense has been committed and that the person apprehended committed it; (2) for pretrial restraint, reasonable grounds for believing that an offense was committed by the person being restrained; and (3) for search, a reasonable grounds for believing that items connected with criminal activity are located in the place or on the person to be searched.

PROCEDURAL LAW— The rules of pleading and practice by which rights are accorded and enforced.

PROCESSING COMMAND— The parent command to which a member is permanently assigned has primary responsibility for administrative processing.

PROVOKING— Tending to incite, irritate, or enrage another.

PROXIMATE CAUSE— That which, in natural and continuous sequence, unbroken by an efficient intervening cause, produces a result, and without which the result would not have occurred.

PROXIMATE RESULT— A reasonably foreseeable result ordinarily following from the lack of care complained of, unbroken by any independent cause.

PUNITIVE ARTICLES— Articles 78 and 80 through 134, UCMJ, that generally describe various crimes and offenses and state how they may be punished.

PUNITIVE DISCHARGE— A discharge imposed as punishment by a court-martial, either a bad-conduct discharge or a dishonorable discharge.

QUALIFIED COUNSEL— Counsel qualified under Article 27(b), UCMJ, and who does not have any direct responsibility for advising the convening authority or separation authority on the proceedings involving the respondent.

RAPE— An act of sexual intercourse with a female, not the accused's wife, done by force and without her consent.

REAL EVIDENCE— Any physical object offered into evidence at trial.

RECESS— A short period of time during which a trial is not in progress.

RECKLESSNESS— An act or omission exhibiting a culpable disregard for the foreseeable consequences of that act or omission; a degree of carelessness greater than simple negligence.

RECONSIDERATION— The action of the convening authority in returning the record of trial to the court for renewed consideration of a ruling of the court dismissing a specification on motion, where the ruling of the court does not amount to a finding of not guilty.

REFERRAL OF CHARGES— The action of a convening authority in directing that a particular case be tried by a particular court-martial previously created.

RELEASE FROM ACTIVE DUTY— Termination of active duty status and transfer or reversion to a Reserve component not on active duty including transfer to the Individual Ready Reserve.

RELEVANCY— That quality of evidence that renders it properly applicable in proving or disproving any matter in issues; a tendency in logic to prove or disprove a fact that is in issue in the case.

REMEDIAL ACTION— Action taken by proper reviewing authorities to correct an error or errors in the proceedings or to offset the adverse impact of an error.

REMISSION— Action by proper authority interrupting the execution of a punishment and canceling out the punishment remaining to be served, while not restoring any right, privilege, or property already affected by the executed portion of the punishment.

REPROACHFUL— Censuring, blaming, discrediting, or disgracing of another's life or character.

RESISTING APPREHENSION— An active resistance to the restraint attempted to be imposed by the person apprehending.

RESPONDENT— A member who has been notified that action has been initiated to separate the member.

RESTRICTION— Moral restraint imposed as punishment, or pretrial restraint upon a person by oral or written orders limiting him or her to specified areas of a military command, with the further provision that he or she will participate in all military duties and activities of his or her organization while under such restriction.

REVISION— A procedure to correct an apparent error or omission or improper or inconsistent action of a court-martial with respect to a finding or a sentence.

SEARCH— A quest for incriminating evidence.

SEIZURE— To take possession of forcibly, to grasp, to snatch, or to put into possession.

SELF-DEFENSE— The use of reasonable force to defend oneself against immediate bodily harm threatened by the unlawful act of another.

SELF-INCRIMINATION— The giving of evidence against oneself that tends to establish guilt of an offense.

SENTENCE— The punishment awarded an accused who is found guilty of an offense by a court-martial.

SEPARATION— A general term that includes discharge, release from active duty, transfer to the Fleet Reserve or Retired List, release from custody and control of the military services, transfer to the Individual Ready Reserve, and similar changes in active or Reserve status.

SEPARATION AUTHORITY— The Chief of Naval Personnel is authorized to take final action with respect to the specified types of separation, or any officer so designated by the Chief of Naval Operations. The Secretary of the Navy is separation authority for release from active duty of member of the Reserve components who are within 2 years of eligibility for retirement or retainer pay. The

separation authority for active duty members being involuntarily separated who have 18 years or more service is the Chief of Naval Operations.

SERIOUS OFFENSE— Offenses under the UCMJ for which a punitive discharge is authorized by the *Manual for Courts-Martial*.

SET ASIDE— Action by proper authority voiding the proceedings and the punishment awarded and restoring all rights, privileges, and property lost by virtue of the punishment imposed

SIMPLE NEGLIGENCE— The absence of due care; for example, an actor omission by a person who is under a duty to use due care that exhibits a lack of that degree of care for the safety of others that a reasonably prudent person would have exercised under the same or similar circumstances.

SOLICITATION— Any statement, oral or written, or any other act or conduct, either directly or through others, that may reasonably be construed as a serious request or advice to commit a criminal offense.

SPECIAL COURT-MARTIAL— The intermediate of the three types of court-martial.

SPECIFICATION— A formal statement of specific acts and circumstances relied upon as constituting the offense charged.

SPONTANEOUS EXCLAMATION— An utterance concerning the circumstances of a startling event made by a person while he or she was in such a condition of excitement, shock, or surprise, caused by his or her participation in or observation of the event, as to warrant a reasonable inference that he or she made the utterance as an impulsive and instinctive outcome of the event, and not as a result of deliberation or design.

STAFF JUDGE ADVOCATE— A certified military lawyer attached to the staff of a convening or supervisory authority who exercises general court-martial jurisdiction.

STATUTE OF LIMITATIONS— The rule of law that, unless waived, establishes the time within which an accused must be charged with an offense to be tried successfully.

STIPULATION— An agreement between the trial and defense counsel, to which the accused agrees, as to the existence or nonexistence of any fact or the content of the testimony that an absent witness

would give if he or she were present in the proceedings.

STRAGGLE— To wander away, to rove, to stray, to become separated from, or to lag or linger behind.

STRIKE— To deliver a blow with anything by which a blow can be given.

SUBPOENA— A formal written instrument or legal process that serves to summon a witness to appear before a certain tribunal and to give testimony.

SUBPOENA DUCES TECUM— A formal written instrument or legal process that commands a witness who has in his or her possession or control some documents or evidentiary object that is pertinent to the issues of a pending controversy to produce it before a certain tribunal.

SUBSCRIBE— To write one's signature on a written instrument as an indication of consent, approval, or attestation.

SUBSTANTIVE LAW— That portion of the body of law that contains rights and duties and regulations of the government.

SUMMARY COURT-MARTIAL— The lowest of the three types of court-martial.

SUPERIOR COMMISSIONED OFFICER— A commissioned officer who is superior in rank or command.

SUPERVISORY AUTHORITY— An officer exercising general court-martial jurisdiction who acts as reviewing authority for SCM and SPCM records after the convening authority has acted.

SUSPECT— A person who is suspected of a crime but who has not been formally charged with its commission by the preferral of charges.

SUSPENSION— Action by proper authority to withhold the execution of a punishment for a probationary period pending good behavior on the part of the accused.

TESTIMONY— Statements made by a witness, under oath, before a court or hearing.

THREAT— An avowed present determination or intent to injure the person, property, or reputation of another presently or in the future.

TOLL— To suspend or interrupt the running of.

TORT— A private of civil wrong or injury committed against a person or property and is independent of any contract.

TRIAL COUNSEL— The person who prosecutes a case in the name of the government.

TRUE OWNER— The person who, at the time of the taking, obtaining, or withholding of property, had the superior right to possession of the property involved in the light of all conflicting interests therein involved in the particular case.

TYPE WARRANTED BY SERVICE RECORD DISCHARGE— Characterization of service is determined by the final average in performance and conduct marks and the final average of the marks in personal behavior.

USAGE— A general habit, mode, or course of procedure.

UTTER— To make any use of, or attempt to make any use of, an instrument known to be false by representing, by words or actions, that it is genuine.

VERBATIM— In the exact words, word for word.

VOIR DIRE— Preliminary examination of court members to determine their competency to sit on the court.

WAIVER— A voluntary or intentional giving up of a known right.

WANTON— Behavior of such a highly dangerous and inexcusable character as to exhibit a callous indifference or total disregard for the probable consequences to the personal safety or property of other persons; heedlessness.

WILLFUL— Deliberate, voluntary, and intentional, as distinguished from acts committed through inadvertence, accident, or ordinary negligence.

WRONGFUL— Contrary to law, regulation, lawful order, or custom.



APPENDIX II

METHODS OF TRANSMITTAL FOR ITEMS OF EVIDENCE

Listed in this appendix are some common items the Master-at-Arms (MA) may have to submit through the mail to a criminal investigations (CI) lab.

All evidence mailed to a lab must be sent "Registered, Return Receipt Requested."

EVIDENCE HANDLING, MARKING, AND PACKING

This chart is not intended to be all-inclusive. If evidence is not found listed herein, consult the specimen list for an item most similar in nature and submit accordingly or contact the appropriate laboratory for advice.

ITEM	HANDLING	MARKING	QUANTITY NEEDED	PRESERVATION AND PACKING	INVESTIGATIVE VALUE
<u>Rope, twine, or cordage</u>	Handle small pieces with tweezers. Avoid damage to large pieces by transferring carefully to the proper container.	Mark on tag or container all pertinent data.	All of specimen. One foot of original.	Place in envelope or evidence bag if small enough; if not, wrap securely.	Used to compare with rope, twine, or cordage used in commission of crime.
<u>Tools</u>	Handle by side of tool after tool has been examined for latent prints.	Mark on side of tools. Do not mark on face of tool. Use string tag with all pertinent data.	All tools. No standard needed.	Place in evidence bag. Prevent damage of the tools.	Used to compare with tool marks.
<u>Tool marks</u>	Cover tool mark with soft paper to avoid damage to the mark.	When tool marks can be transferred to laboratory unit, inscribe name and date on object containing tool marks. Do not mark.	Complete tool marks. Suspected tool, when available.	Keep from contaminating the mark.	Used for comparison purposes.
<u>Safe insulation and soil samples</u>	For a summary on handling safe insulation and soil samples, see chapter 16.	Label outside of container with pertinent data.	All of questioned specimen. Up to 4 ounces for standard.	Packed in sealed container large enough to accommodate volume.	Used for comparison purposes.
<u>Arson or fire bomb</u> 1. <u>Liquid</u>	Leave in original container. Check for latent prints. Remove liquid from original container. Check containers for latent prints.	Place a label on the outside of container indicating the place where specimen was taken, date, time, complaint number, and name of submitting investigator.	Up to 4 ounces. No standard needed.	Place in 4-ounce metal container and seal securely. To ensure chain of custody, place a seal of masking tape or packaging tape over top and have submitting investigator sign.	Used to determine properties and the fluid, which may be used as inventive leads.
2. <u>Nonliquid; i.e., ashes and debris taken from point of origin; all mechanical or electrical devices that may have been used to ignite the fire.</u>	Use tweezers for small particles. Handle with extreme care. Use piece of stiff paper to slide under ash.	Same as above.	All of specimen if small. Representative sample if large.	Place the specimen in a clean, unused, unlined paint can. Handle as carefully as possible to keep specimen intact.	Used to determine elements used to create the fire, thereby possibly finding a modus operandi.

EVIDENCE HANDLING, MARKING, AND PACKING

ITEM	HANDLING	MARKING	QUANTITY NEEDED	PRESERVATION AND PACKING	INVESTIGATIVE VALUE
<p>Blood 1. Liquid Known samples</p>	<p>For a summary on the techniques for handling blood samples, see preservation and packing column. Same as above.</p>	<p>Use adhesive tape outside of test tube. Name of donor, date taken, doctor's name, name or initials of submitting agent, and case number. Same as above.</p>	<p>5cc. in sterile test tube. No standard needed.</p>	<p>Sterile test tube only. No preservation for grouping test. Wrap in cotton or soft paper.</p>	<p>Used to determine blood group and content of alcohol in blood.</p>
<p>Questioned samples</p>	<p>Same as above.</p>	<p>Use string tag and label. All pertinent data must be furnished.</p>	<p>Up to 5cc. No standard needed.</p>	<p>Collect by using eyedropper or clean spoon. When possible use a clean test tube, otherwise transfer blood to a nonporous surface (glass). Allow to dry and submit in pillbox that can be sealed.</p>	<p>Used to determine blood group and nature of blood (whether human or animal).</p>
<p>Clothing (Contaminated)</p>	<p>Take care not to loosen any trace materials from the garment.</p>	<p>Use string tag and label. All pertinent data must be furnished.</p>	<p>All clothing. No standard needed.</p>	<p>Pack only when dry. Do not cut through contaminated portion of clothes. Each article will be wrapped individually in a clean dry evidence bag. Information relative to the offense must be included on the evidence bag.</p>	<p>Used to determine what use contamination is; e.g., blood, powder burns, semen, etc., and what it indicates.</p>
<p>Documents (Letters, notes, checks, etc.)</p>	<p>Use tweezers. Do not place tweezers over any obvious smudge. Protect for latent prints. Do not staple or paper clip together. Use paper envelopes larger than the document whenever possible.</p>	<p>Place initial and date on outside of the sealed envelope or other container used to package the document. Document should be marked by initials or identifying mark in an area that will not destroy evidentiary value.</p>	<p>All documents. No standard needed.</p>	<p>Document should be handled, folded, and marked as little as possible. If folding cannot be avoided, the fold should be along old lines. Place in proper enclosure envelope and seal with transparent tape. Flap side of envelope should contain title of case, description of contents, complaint number, and submitting investigator's name.</p>	<p>Used to determine possible identity of authorship and to check for fingerprints, alterations, erasure, or forgery.</p>
<p>Fibers</p>	<p>Fibers are usually obtained through vacuum sweeping with a special filter attachment.</p>	<p>Label outside of seal container.</p>	<p>All fibers. Original garment or cloth, if possible.</p>	<p>Pack in folded paper and place in envelope or pillbox. Seal tightly to prevent loss.</p>	<p>Used to compare fiber at scene with suspect material.</p>

EVIDENCE HANDLING, MARKING, AND PACKING

ITEM	HANDLING	MARKING	QUANTITY NEEDED	PRESERVATION AND PACKING	INVESTIGATIVE VALUE
Fingerprints 1. Latent Lifts	For a summary on the technique for handling latent lifts, see preservation and packing column.	On the back of the card to which the prints are transferred. All pertinent information must be furnished.	All latent prints. The names of all law enforcement personnel at the scene and elimination prints of all people who have legal access to the area or object in question.	The print must be transferred from the object to a nonporous card. The card must be sealed into a fingerprint envelope.	Used to identify positively with who was at the scene.
2. Paper for chemical	Paper should be handled as little as possible. Do not fold. Roll only when absolutely necessary. Use tweezers if possible or cotton gloves.	Mark as little as possible (i.e., initials). All other pertinent information on the evidence container.	Same as above.	Same as Documents.	Used to determine if latent prints are present.
Firearms 1. Handgun	Handle only by the knurled portion of the handgrips until processed for fingerprints.	Scratch initials or marks of identification in an inconspicuous place on the frame. Do not mark an "X." Do not mark on parts of weapon that can be easily removed.	All. No standard needed.	Attach string tag with pertinent information included on it. Place in heavy paper envelope. NEVER SUBMIT A LOADED WEAPON!	Used to determine if weapon was fired or for firearms identification.
2. Rifle/shotgun	Handle by the trigger guard edge and the serrated parts of the stock and forepiece as purchase points.	Same as above.	All. No standard needed.	Attach string tag with pertinent information included.	Same as above.
Ammunition 1. Bullets fired	Use tweezers with taped ends. Avoid damage to rifling marks on the circumference.	Mark with initials either on base or nose of bullet. Do not mark on sides.	All fired bullets. No standard needed.	Wrap in soft paper tissue and place in small pillbox. Box should be marked with pertinent information.	Used to determine make, caliber, and type of firearm from which bullet could have been disengaged.
2. Bullet and cartridge case	Use tweezers with taped ends. Avoid damage to the case or the bullet.	Mark with initials, date, and numbers that correspond with chamber, if taken from a revolver, on the nose of the bullet.	All bullets. No standard needed.	Same as above.	Used for comparison purposes.

EVIDENCE HANDLING, MARKING, AND PACKING					
ITEM	HANDLING	MARKING	QUANTITY NEEDED	PRESERVATION AND PACKING	INVESTIGATIVE VALUE
3. Cartridge case (fired)	Pick up at the open end with tweezers. Avoid scratching.	Mark on the inside of the casing, or on the outside as near the front as possible.	All cases. No standard needed.	Same as above.	Used to determine make, caliber, and type of firearms. Also for future comparisons if weapons not recovered.
4. Shot shells (fired)	Same as above.	Mark on side of brass head of shell using agent's initials. Do not scratch, nick, mar, or mutilate base of shell.	All shells. No standard needed.	Roll individually in paper and place in paper envelope.	Used to determine the gauge of gun and for comparison of weapon marks.
5. Shot pellets	Use tweezers with taped ends. Avoid damage to rifling.	Place pellets in small pillbox, seal box, and mark properly.	All pellets. No standard needed.	Same as Methods of Marking.	The size of the shot may be consistent with other ammunition found on suspect.
6. Wadding	Use tweezers, avoid any damage to the wadding.	Mark with ink by inscribing initials of recovering investigators.	All wadding. No standard needed.	Place in paper envelope.	Size of shot and gauge designation of arm firing wads.
<u>Glass</u> 1. Fragments	Use fingers on the edge of the larger piece. Do not touch flat surfaces. Do not grasp over obvious smudges. Process for latent prints where indicated.	Mark container with name of submitting agent and other pertinent data. Separate questioned and known pieces.	All fragments. No standard needed.	Wrap each piece in cotton or soft pack to prevent shifting and further breakage.	Used to identify fragments taken from scene of crime. Used to determine direction of break force.
2. Particles	Use tweezers for pieces too small for fingers.	Same as above.	All particles. Three-inch piece of broken item as standard.	Place in pillbox, seal, and protect from further breakage.	Same as above.
<u>Hair</u>	Carefully remove hairs from crime scene with a pair of tweezers.	Same as above.	All portions of hair found at scene. Twenty or more pulled hairs when removed from a person.	Fold clean sheet of paper, place hair in fold, and place in envelope.	Used to determine color, structure, etc.

EVIDENCE HANDLING, MARKING, AND PACKING

ITEM	HANDLING	MARKING	QUANTITY NEEDED	PRESERVATION AND PACKING	INVESTIGATIVE VALUE
<p>Impressions</p> <ol style="list-style-type: none"> 1. Footprints 2. Tire prints 3. Small impressions 	<p>For a summary of the technique for handling impressions, see chapter 7.</p>	<p>Photograph the impression and include a ruler in the picture to keep in proper perspective. Label back of picture with pertinent data.</p>	<p>Enough photographs to show full impression from all angles.</p>	<p>Place in property envelope and seal.</p>	<p>Used for comparison purposes.</p>
<p><u>Liquid</u> Poison, acid, and others</p>	<p>Leave in original container. Examine container for latent prints.</p>	<p>On outside of container, place a label with pertinent information.</p>	<p>If container adequate, all of specimen. Otherwise, up to 4 ounces.</p>	<p>If in glass container, pack absorbent material around it and place in strongbox.</p>	<p>Used to determine the actual content of the fluid.</p>
<p><u>Liquor</u></p>	<p>Same as above.</p>	<p>Inscribe identifying mark on metal can or label with pen.</p>	<p>All of specimen. No standard needed.</p>	<p>Place in paper evidence bag and label appropriately.</p>	<p>Used to determine alcoholic content.</p>
<p><u>Suspected Narcotics and Dangerous Drugs</u></p>	<p>Leave in original container. Examine container for latent prints.</p>	<p>Place label with pertinent data on outside of container.</p>	<p>All of specimen. No standard needed.</p>	<p>Pack absorbent material around all glass to prevent breakage. Label "Fragile."</p>	<p>May show the substance is not narcotic or dangerous or will identify the drug recovered.</p>
<p>Tablets, powder, and solids.</p>	<p>Use tweezers or small brush to transfer any particles to the proper container.</p>	<p>Same as above.</p>	<p>All of specimen. No standard needed.</p>	<p>Place in properly sealed pillbox or adequate to prevent loss.</p>	
<p><u>Paint</u> 1. Liquid</p>	<p>Leave sample in original container, if possible. If transfer is necessary, pour cautiously, being careful not to spill any of the sample.</p>	<p>Place label with all pertinent data on the container.</p>	<p>All if in good container; otherwise, up to 4 ounces. An original unopened container up to 1 gallon for standard.</p>	<p>Pack to prevent undue breakage or spillage.</p>	<p>Used to determine texture and content for comparison.</p>
<p>2. Chips</p>	<p>Handle with tweezers or scoop chips with a piece of paper. Chips should be collected as is to keep them intact.</p>	<p>Mark the sealed container with pertinent data.</p>	<p>All of specimen. When possible, an adequate amount of material from suspected object to be used as standard.</p>	<p>Place in pillbox or other rigid container.</p>	<p>Chips found at scene may be traced to suspect and used for comparison.</p>

CRIME LABORATORY REQUEST FORM

Evidence submitted to a laboratory for analysis must be accompanied by a Department of the Navy Forensic Examination Request, OPNAV Form 5527/15. This form will serve as a letter of transmittal for the evidence. It is not necessary to prepare a separate letter of transmittal for W-3 government laboratories such as the FBI Laboratory.

DEPARTMENT OF THE NAVY FORENSIC EXAMINATION REQUEST		1. CASE CONTROL NUMBER (CCN) 2. PRIORITY OF EXAM <input type="checkbox"/> Routine <input type="checkbox"/> Urgent <input type="checkbox"/> As soon as possible		
3. TO (Include Attention Line)		4. FROM		
5. CASE FACTS (Brief description pertaining to the requested examination which may assist laboratory personnel in processing the evidence. Include date and place of crime.)				
6. EVIDENCE SUBMITTED <table border="1" style="width: 100%; border-collapse: collapse;"> <tr> <td style="width: 25%; vertical-align: top;">a. Item Number</td> <td style="vertical-align: top;">b. Item Description</td> </tr> </table>			a. Item Number	b. Item Description
a. Item Number	b. Item Description			
7. EXAMINATIONS AND/OR COMPARISONS REQUESTED				
8. SUSPECT'S FULL NAME		9. VICTIM'S FULL NAME		
10. TYPE OF OFFENSE				
11. IS ONE COPY OF EVIDENCE CUSTODY DOCUMENT ENCLOSED? <input type="checkbox"/> Yes <input type="checkbox"/> No				
12. HAS OTHER EVIDENCE PREVIOUSLY BEEN SUBMITTED FOR THIS CASE? <input type="checkbox"/> No <input type="checkbox"/> Yes (List Lab Report Number)				
13. INVESTIGATOR'S NAME AND OFFICE PHONE NUMBER				
14. DISPOSITION OF EVIDENCE AFTER ANALYSIS/COMPARISON <table border="1" style="width: 100%; border-collapse: collapse;"> <tr> <td style="width: 50%; vertical-align: top;">a. Item Number</td> <td style="vertical-align: top;">b. Disposition</td> </tr> </table>			a. Item Number	b. Disposition
a. Item Number	b. Disposition			
15. CERTIFICATION I CERTIFY THAT THIS EVIDENCE HAS NOT BEEN SUBJECTED TO EXAMINATION BY OTHER EXPERTS FOR THE PROSECUTION IN THE SAME SCIENTIFIC FIELD AS REQUESTED HEREIN.				
a. Date	b. Requester Typed or Printed Name	c. Requester Signature		

OPNAV 5527-15 (17-82)

S/N 0107 17 095 27 11

APPENDIX III

PUNITIVE ARTICLES OF THE UCMJ

Articles 77 through 134 of the UCMJ are referred to as punitive articles, which cover almost any offense or crime that can be committed. Although Article 77 is defined as a punitive article, it is not punitive in nature. *The Manual for Courts-Martial* [Part IV, Punitive Articles] contains specific information about each article. You should also consult Part IV of the *MCM* to obtain the proper specifications used when writing charges for NJP or Courts-Martial proceedings.

You must remember to establish proof that the accused committed the alleged offense. All ELEMENTS of an offense MUST be met before the accused can be charged with the offense. You should refer to the *Manual of Courts-Martial (MCM)* to establish proof of guilt.

The following chart identifies and briefly discusses each article. For brevity, the word *servicemember* is used to mean any person subject to the *UCMJ*, and *offense* is used to mean a violation punishable by the punitive articles of the *UCMJ*.

Article	Description
77	Principals. Any servicemember who commits an offense, or aids, abets, counsels, commands, or procures its commission, or causes an act that if done by him or her would be punishable by the punitive articles of the UCMJ is a principal.
78	Accessory after the Fact. A service member who, knowing that an offense has been committed, receives, comforts, or assists the offender to hinder or prevent his or her apprehension, trial, or punishment is punishable as a court-martial may direct.
79	Conviction of lesser included offenses. An accused maybe found guilty of an offense necessarily included in the offense charged or of an attempt to commit the offense charged.
80	Attempt. An act done with specific intent to <u>commit</u> an offense (amounting to more than mere preparation and tending), even though failing, is an attempt to commit that offense.
81	Conspiracy. A servicemember who conspires with any other person to commit an offense, if one or more of the conspirators does an act to effect the object of the conspiracy, is punishable as a court-martial may direct.
82	<p>Solicitation. A servicemember who solicits or advises another or others to desert (in violation of section 885 of this title [Art. 85] or mutiny (in violation of section 894 [Art. 94]), if the offense solicited or advised is attempted or committed, is punishable with the punishment provided for the commission of the offense; but if the offense solicited or advised is not committed or attempted, he or she is punishable as a court-martial may direct.</p> <p>A servicemember who solicits or advises another or others to commit an act of misbehavior before the enemy (in violation of section 899 [Art. 99]) or sedition (in violation of section 894 [Art. 94]), if the offense solicited or advised is committed, is punishable with the punishment provided for the commission of the offense, but if the offense solicited or advised is not committed, is punishable as a court-martial may direct.</p>
83	<p>Fraudulent enlistment, appointment or separation. An act of procuring enlistment or appointment in the Armed Forces through deliberate false representation or deliberate concealment of qualifications for that enlistment or appointment and under which pay or allowances were received.</p> <p>An act of procuring separation from the Armed Forces through false representation or deliberate concealment of eligibility for that separation is punishable as a court-martial may direct.</p>
84	Effecting unlawful enlistment, appointment or separation. A servicemember who effects an enlistment or appointment in or a separation from the Armed Forces of any person who is known by him or her to be ineligible for that enlistment, appointment, or separation because it is prohibited by law, regulation, or order is punishable as a court-martial may direct.
85	<p>Desertion. Any servicemember who without authority leaves his unit, organization, or place of duty with intent to stay away permanently is guilty of desertion.</p> <p>A servicemember who deserts or attempts to desert, if the offense is committed in time of war, is punishable by death or such other punishment as a court-martial may direct; but if the desertion or attempt to desert occurs at any other time, by such punishment other than death that a court-martial may direct.”</p>
86	Absence without leave. Any member of the Armed Forces who without authority fails to go to his or her appointed place of duty at the time prescribed, or absents himself or herself and remains absent from the unit, organization, or place of duty at which required to be at the time required is absent without leave and is punishable as a court-martial may direct.

Article	Description
87	Missing movement. A servicemember who through neglect or design misses the movement of a ship, aircraft, or unit with which he or she is required in the course of duty to move is punishable as a court-martial may direct.
88	Contempt toward officials. Any commissioned officer who uses contemptuous words against the President, the Vice President, Congress, the Secretary of Defense, the Secretary of a military department, the Secretary of Transportation, or the Governor or legislature of any State, Territory, Commonwealth, or possession in which he is on duty or present is guilty of contempt toward that official and is punishable as a court-martial may direct.
89	Disrespect toward a superior commissioned officer. A servicemember who behaves with disrespect toward his or her superior commissioned officer is punishable as a court-martial may direct.
90	Assaulting or willfully disobeying superior commissioned officer. A servicemember who strikes his or her superior commissioned officer or draws or lifts up any weapon or offers any violence against that officer or willfully disobeys a lawful command of that superior commissioned officer while the officer is in the execution of his or her office, if the offense is committed in time of war, is punishable by death or such other punishment as a court-martial may direct; if the offense is committed at any other time, by such punishment other than death that a court-martial may direct.
91	Insubordinate conduct toward warrant officer, noncommissioned officer, or petty officer. Any warrant officer or enlisted member who strikes or assaults a warrant officer, noncommissioned officer, or petty officer; who willfully disobeys a lawful order of a warrant officer, noncommissioned officer, or petty officer; or who treats with contempt or is disrespectful in language or deportment toward a warrant officer, noncommissioned officer, or petty officer while that officer is in the execution of his office is guilty of insubordination and is punishable as a court-martial may direct.
92	Failure to obey order or regulation. A servicemember who (1) violates or fails to obey any lawful general order or regulation, (2) having knowledge of any other lawful order issued by a member of the Armed Forces, which it is his duty to obey, fails to obey the order or (3) is derelict in the performance of his duties is punishable as a court-martial may direct.
93	Cruelty and maltreatment. A servicemember who is guilty of cruelty toward, or oppression or maltreatment of, any person subject to his orders is punishable as a court-martial may direct.
94	<p>Mutiny and sedition. A servicemember who, with intent to usurp or override lawful military authority, refuses, with any other person, to obey orders or otherwise do his or her duty or creates any violence or disturbance is guilty of mutiny.</p> <p>A servicemember who with intent to cause the overthrow or destruction of lawful civil authority, creates, with any other person, revolt, violence, or other disturbance against that authority is guilty of sedition.</p> <p>A servicemember who fails to do his or her utmost to prevent, or suppress, a mutiny or sedition being committed in his or her presence, or who fails to take all reasonable means to inform his or her superior commissioned officer or commanding officer of a mutiny or sedition that is known or believed to be taking place, is guilty of a failure to suppress or report a mutiny or sedition.</p> <p>A person who is found guilty of attempted mutiny, mutiny, sedition, or failure to suppress or report a mutiny or sedition is punishable by death or such other punishment as a court-martial may direct.</p>

Article	Description
95	Resistance breach of arrest and escape. A servicemember who resists apprehension or breaks arrest or who escapes from custody or confinement is punishable as a court-martial may direct.
96	Releasing prisoner without proper authority. A servicemember who, without proper authority, releases any prisoner committed to his charge, or who through neglect or design, allows any prisoner to escape, is punishable as a court-martial may direct, whether or not the prisoner was committed in strict compliance with law.
97	Unlawful detention. A servicemember who, except as provided by law, apprehends, arrests, or confines any person is punishable as a court-martial may direct.
98	Noncompliance with procedural rules. A servicemember who is responsible for unnecessary delay in the disposition of any case of a person accused of an offense, or who knowingly and intentionally fails to enforce or comply with any provision of the articles regulating the proceedings before, during, or after trial of an accused is punishable as a court-martial may direct.
99	<p>Misbehavior before the enemy. Any servicemember who before or in the presence of the enemy—</p> <ol style="list-style-type: none"> 1. runs away; 2. shamefully abandons, surrenders, or delivers up any command, unit, place, or military property that it is his duty to defend; 3. through disobedience, neglect, or intentional misconduct, endangers the safety of any such command, unit, place, or military property; 4. casts away his arms or ammunition; 5. is guilty of cowardly conduct; 6. quits his place of duty to plunder or pillage; 7. causes false alarms in any command, unit, or place under control of the Armed Forces; 8. willfully fails to do his utmost to encounter, engage, capture, or destroy any enemy troops, combatants, vessels, aircraft, or any other thing, which it is his duty so to encounter, engage, capture, or destroy; or 9. does not afford all practicable relief and assistance to any troops, combatants, vessels, or aircraft of the Armed Forces belonging to the United States or their allies when engaged in battle; <p>is punishable by death or such other punishment as a court-martial may direct.</p>
100	Subordinate compelling surrender. A service member who compels or attempts to compel a commander of military property or of any body of members of the Armed Forces to give such property up to the enemy or to abandon it, or who strikes the colors or flag to the enemy without proper authority is punishable by death or such other punishment as a court-martial may direct.
101	Improper use of countersign. A servicemember who in time of war discloses the parole or countersign to any person not entitled to receive it, or who, having knowledge that he or she was authorized and required to give the parole or countersign, gives a false parole or countersign to a person entitled to receive and use it is punishable by death or such other punishment as a court-martial may direct.

Article	Description
102	Forcing a safeguard. A servicemember who forces a safeguard shall suffer death or such other punishment as a court-martial may direct.
103	<p>Captured or abandoned property. All persons must secure all public property taken from the enemy for the service of the United States, and must give notice and turnover to the proper authority without delay all captured or abandoned property in their possession, custody, or control. Any person who</p> <ol style="list-style-type: none"> 1. fails to carry out prescribed duties; 2. buys, sells, trades, or in any way deals in or disposes of captured or abandoned property and receives or expects profit, benefit, or advantage to self or another directly or indirectly connected with self; or 3. engages in looting or pillaging; <p>is punishable as a court-martial may direct.</p>
104	Aiding the enemy. A servicemember who aids, or attempts to aid, the enemy with arms, ammunition, supplies, money, or other things; or without proper authority, knowingly harbors or protects or gives intelligence to or communicates or corresponds with or holds any intercourse with the enemy, either directly or indirectly, shall suffer death or such other punishment as a court-martial or military commission may direct.
105	Misconduct as a prisoner. A servicemember who, while in the hands of the enemy in time of war, for the purpose of securing favorable treatment by his captors, acts without proper authority in a manner contrary to law, custom, or regulation, to the detriment of others of whatever nationality held by the enemy as civilian or military prisoners, or while in a position of authority over such persons maltreats them without justifiable cause is punishable as a court-martial may direct.
106	Spies. A servicemember who in time of war is found lurking as a spy or acting as a spy in or about any place, vessel, or aircraft within the control or jurisdiction of any of the Armed Forces, or in or about any shipyard, any manufacturing or industrial plant, or any other place or institution engaged in work in aid of the prosecution of the war by the United States, or elsewhere, shall be tried by a general court-martial or by a military commission and on conviction shall be punished by death.
106a	Espionage. Any person who, with intent or reason to believe that information or an article is to be used to the injury of the United States or to the advantage of a foreign nation, communicates, delivers, or transmits, or attempts to communicate, deliver, or transmit, either directly or indirectly, the information or article, is punishable as a court-martial may direct, except that if the accused is found guilty of an offense that directly concerns (a) nuclear weaponry, military spacecraft or satellites, early warning systems, or other means of defense or retaliation against large scale attack (b) war plans, (c) communications intelligence or cryptographic information, or (d) any other major weapons system or major element of defense strategy, the accused shall be punished by death or such other punishment as a court-martial may direct.
107	False official statements. A servicemember who, with intent to deceive, signs any false record, return, regulation, order, or other official document, knowing it to be false, or makes any other false official statement, knowing it to be false, is punishable as a court-martial may direct.

Article	Description
108	<p>Military property of the United States-sale, loss, damage destruction, or wrongful disposition. A servicemember who, without proper authority-</p> <ol style="list-style-type: none"> 1. sells or otherwise disposes of: 2. willfully or through neglect damages, destroys, or loses; or 3. willfully or through neglect suffers to be lost, damaged, destroyed, sold or wrongfully disposed of, any military property of the United States, is punishable as a court-martial may direct.
109	<p>Property other than military property of the United States-waste, spoilage or destruction. A servicemember who willfully or recklessly wastes, spoils, or otherwise willfully and wrongfully destroys or damages any property other than military property of the United States shall be punished as a court-martial may direct.</p>
110	<p>Improper hazarding of vessel. A servicemember who willfully and wrongfully hazards or suffers to be hazarded any vessel of the Armed Forces shall suffer death or such other punishment as a court-martial may direct.</p> <p>Any servicemember who negligently hazards or suffers to be hazarded any vessel of the Armed Forces shall be punished as a court-martial may direct.</p>
111	<p>Drunken or reckless driving. A servicemember who operates any vehicle while drunk or in a reckless or wanton manner, or while impaired by a substance described in section 912a(b) of this title (Article 112a(b)), is punishable as a court-martial may direct.</p>
112	<p>Drunk on duty. A servicemember other than sentinel or look-out, who is found drunk on duty is punishable as a court-martial may direct.</p>
112a	<p>Wrongful use possession, etc., of controlled substances. Any servicemember who wrongfully uses, possesses, manufactures, distributes, imports into the customs territory of the United States, exports from the United States, or introduces into an installation, vessel, vehicle, or aircraft used by or under the control of the Armed Forces a substance described in subsection (b) of this article is punishable as a court-martial may direct.</p> <p>The substances referred to in subsection (a) are the following:</p> <ol style="list-style-type: none"> (1) opium, heroin, cocaine, amphetamine, lysergic acid diethylamide, methamphetamine, phencyclidine, barbituric acid, and marijuana, and any compound or derivative of any such substance. (2) Any substance not specified in clause (1) that is listed on a schedule of controlled substances prescribed by the President for the purposes of this article. (3) Any other substance not specified in clause (1) or contained on a list prescribed by the President under clause (2) that is listed in Schedules I through V of section 202 of the Controlled Substances Act (21 U.S.C. 812).
113	<p>Misbehavior of sentinel or lookout. Any sentinel or lookout who is found drunk or sleeping at his or her post, or leaves it before being regularly relieved, shall be punished, if the offense is committed in time of war, by death or such other punishment as a court-martial may direct; if the offense is committed at any other time, by such punishment other than death as a court-martial may direct.</p>

Article	Description
114	Dueling. A servicemember who fights or promotes, or is concerned in or connives at fighting a duel, or who, having knowledge of a challenge sent or about to be sent, fails to report the fact promptly to the proper authority, is punishable as a court-martial may direct.
115	Malingering. Any servicemember who for the purpose of avoiding work, duty, or service feigns illness, physical disablement, mental lapse or derangement; or intentionally inflicts self-injury; is punishable as a court-martial may direct.
116	Riot or breach of peace. A servicemember who causes or participates in any riot or breach of the peace is punishable as a court-martial may direct.
117	Provoking speeches or gestures. A servicemember who uses provoking or reproachful words or gestures towards any other person is punishable as a court-martial may direct.
118	<p>Murder. A servicemember who, without justification or excuse, unlawfully kills a human being, when he or she—</p> <ol style="list-style-type: none"> 1. has a premeditated design to kill; 2. intends to kill or inflict great bodily harm; 3. is engaged in an act that is inherently dangerous to others and evidences a wanton disregard of human life; 4. is engaged in the perpetration or attempted perpetration of burglary, sodomy, rape, robbery, or aggravated arson; <p>is guilty of murder, and shall suffer such punishment as a court-martial may direct, except that if found guilty under (1) or (4), shall suffer death or imprisonment for life as a court-martial may direct.</p>
119	<p>Manslaughter. Any servicemember who, with an intent to kill or inflict great bodily harm, unlawfully kills a human being in the heat of sudden passion caused by adequate provocation is guilty of voluntary manslaughter and shall be punished as a court-martial may direct. Any servicemember who, without an intent to kill or inflict great bodily harm, unlawfully kills a human being—</p> <ol style="list-style-type: none"> 1. by culpable negligence; or 2. while perpetrating or attempting to perpetrate an offense, other than those named in clause (4) of section 918 of this title (Article 118), directly affecting the person; is guilty of involuntary manslaughter and shall be punished as a court-martial may direct.
120	<p>Rape and carnal knowledge. Any servicemember who commits an act of sexual intercourse with a female not his wife, by force and without her consent, is guilty of rape and shall be punished by death or such other punishment as a court-martial may direct.</p> <p>Any servicemember who, under circumstances not amounting to rape, commits an act of sexual intercourse with a female-not his wife-who has not attained the age of 16 years, is guilty of carnal knowledge and is punishable as a court-martial may direct.</p> <p>Penetration, however slight, is sufficient to complete either of these offenses.</p>

Article	Description
121	<p>Larceny and wrongful appropriation. A servicemember who wrongfully takes, obtains, or withholds, by any means, from the possession of the owner or of any other person any money, personal property, or article of value of any kind-</p> <p>1. with intent permanently to deprive or defraud another person of the use and benefit of property or to appropriate it to his or her own use or the use of any person other than the owner, steals that property and is guilty of larceny;</p> <p>2. with intent temporarily to deprive or defraud another person of the use and benefit of property or to appropriate it to his or her own use or the use of any person other than the owner, is guilty of wrongful appropriation.</p> <p>Any person found guilty of larceny or wrongful appropriation shall be punished as a court-martial may direct.</p>
122	<p>Robbery. A servicemember who with intent to steal takes anything of value from the person or in the presence of another, against his will, by means of force or violence or fear of immediate or future injury to his person or property or to the person or property of a relative or member of his family or of anyone in his company at the time of the robbery, is guilty of robbery and shall be punished as a court-martial may direct.</p>
123	<p>Forgery. A servicemember who with intent to defraud falsely, makes or alters any signature to, of any part of, any writing that would, if genuine, apparently impose a legal liability on another or change his legal right or liability to his prejudice; or utters, offers, issues, or transfers such a writing, known by him to be so made or altered; is guilty of forgery and shall be punished as a court-martial may direct.</p>
123a	<p>Making, drawing, or uttering check, draft, or order without sufficient funds. A servicemember who, for the procurement of any article or thing of value, with intent to defraud; or for the payment of any past due obligation, or for any other purpose, with intent to deceive; makes, draws, utters, or delivers any check, draft, or order for the payment of money upon any bank or other depository, knowing at the time that the maker or drawer has not or will not have sufficient funds in, or credit with, the bank or other depository for the payment of that check, draft, or order in full upon its presentment, shall be punished as a court-martial may direct. The making, drawing, uttering, or delivering by a maker or drawer of a check, draft, or order, payment of which is refused by the drawee because of insufficient funds of the maker or drawer in the drawee's possession or control is prima facie evidence of his intent to defraud or deceive and of his knowledge of insufficient funds in, or credit with, that bank or other depository, unless the maker or drawer pays the holder the amount due within 5 days after receiving notice, orally or in writing, that the check draft, or order was not paid on presentment. In this section, the word <i>credit</i> means an arrangement or understanding, expressed or implied, with the bank or other depository for the payment of that check draft, or order.</p>
124	<p>Maiming. A servicemember who, with intent to injure, disfigure, or disable, inflicts upon another an injury that seriously disfigures by any mutilation thereof; destroys or disables any member or organ of his or her body; or seriously diminishes the physical vigor by the injury of any member or organ; is guilty of maiming and shall be punished as a court-martial may direct.</p>
125	<p>Sodomy. A service member who engages in unnatural carnal copulation with another person of the same or opposite sex or with an animal is guilty of sodomy. Penetration, however slight, is sufficient to complete the offense. Any person found guilty of sodomy shall be punished as a court-martial may direct.</p>

Article	Description
126	<p>Arson. Any servicemember who willfully and maliciously burns or sets on fire an inhabited dwelling, or any other structure, movable or immovable, and knows the structure is occupied, is guilty of aggravated arson and shall be punished as a court-martial may direct.</p> <p>Any servicemember who willfully and maliciously burns or sets fire to the property of another, except as provided above, is guilty of simple arson and shall be punished as a court-martial may direct.</p>
127	<p>Extortion. A servicemember who communicates threats to another person with the intention to obtain anything of value or any acquittance, advantage, or immunity is guilty of extortion and shall be punished as a court-martial may direct.</p>
128	<p>Assault. Any servicemember who attempts or offers with unlawful force or violence to do bodily harm to another person, whether or not the attempt or offer is consummated, is guilty of assault and shall be punished as a court-martial may direct.</p> <p>Any servicemember who–</p> <ol style="list-style-type: none"> 1. commits an assault with a dangerous weapon or other means or force likely to produce death or grievous bodily harm, 2. commits an assault and intentionally inflicts grievous bodily harm, with or without a weapon, <p>is guilty of aggravated assault and shall be punished as a court-martial may direct.</p>
129	<p>Burglary. A servicemember who, with intent to commit an offense punishable under sections 918-928 of this title (Articles 118-128), breaks and enters, in the nighttime, the dwelling of another, is guilty of burglary and shall be punished as a court-martial may direct.</p>
130	<p>Housebreaking. A servicemember who unlawfully enters the building or structure of another with intent to commit a criminal offense therein is guilty of housebreaking and shall be punished as a court-martial may direct.</p>
131	<p>Perjury. A servicemember who, in a judicial proceeding or in a course of justice, willfully and corruptly–</p> <ol style="list-style-type: none"> 1. upon a lawful oath or in any form allowed by law to be substituted for an oath, gives any false testimony material to the issue or matter of inquiry; or 2. in any declaration, certificate, verification, or statement under penalty of perjury as permitted under section 1746 of Title 28, United States Code, subscribes any false statement material to the issue or matter of inquiry; <p>is guilty of perjury and shall be punished as a court-martial may direct.</p>

Article	Description
132	<p>Frauds against the United States. A servicemember–</p> <ol style="list-style-type: none"> 1. who, knowing it to be false or fraudulent– <ol style="list-style-type: none"> a. makes any claim against the United States or any officer thereof; or b. presents to any person in the civil or military service thereof, for approval or payment, any claim against the United States or any officer thereof; 2. who, for the purpose of obtaining the approval, allowance, or payment of any claim against the United States or any officer thereof– <ol style="list-style-type: none"> a. makes or uses any writing or other paper, knowing it to contain any false or fraudulent statements; b. makes any oath to any factor to any writing or other paper, knowing the oath to be false; or c. forges or counterfeits any signature upon any writing or other paper, or uses any such signature, knowing it to be forged or counterfeited; 3. who, having charge, possession, custody, or control of any money, or other property of the United States, furnished or intended for the Armed Forces thereof, knowingly delivers to any person having authority to receive it, any amount thereof less than that for which he receives a certificate or receipt; or 4. who, being authorized to make or deliver any paper certifying the receipt of any property of the United States furnished or intended for the Armed Forces thereof, makes or delivers to any person such writing without having full knowledge of the truth of the statements therein contained and with intent to defraud the United States, shall upon conviction, be punished as a court-martial may direct.
133	<p>Conduct unbecoming an officer and gentleman. Any commissioned officer, cadet, or midshipman who is convicted of conduct unbecoming an officer and a gentleman shall be punished as a court-martial may direct.</p>
134	<p>General article. Though not specifically mentioned in this article, all disorders and neglects to the prejudice of good order and discipline in the Armed Forces, all conduct of a nature to bring discredit upon the Armed Forces, and crimes and offenses not capital, of which persons subject to the UCMJ may be guilty, shall be taken cognizance of by a general, special, or summary court-martial, according to the nature and degree of the offense, and shall be punished at the discretion of that court. Note: See the <i>MCM</i> for the specific sections of Article 134 that may apply.</p>

APPENDIX IV

REFERENCES USED TO DEVELOP THE TRAMAN

NOTE: Although the following references were current when this TRAMAN was published, their continued currency cannot be assured. You, therefore, need to be sure you are studying the latest revision.

Chapter 1

Standard Organization and Regulations of the U.S. Navy, OPNAVINST 3120.32B, Chief of Naval Operations, Washington, DC, 1986.

United States Navy Regulations, Office of the Secretary, Washington, DC, 1990.

United States Navy Uniform Regulations, NAVPERS 15665H, Bureau of Naval Personnel Washington, DC, 1991.

Chapter 2

Manual for Courts-Martial (MCM), United States, 1984.

Manual of the Judge Advocate General (JAGMAN), JAGINST 5800.7C, Office of the Judge Advocate General, Alexandria, VA, 1991.

Naval Justice School Commander's Handbook, Newport, RI, 1991.

Naval Justice School Evidence Study Guide, Newport, RI, 1990.

Naval Justice School Military Justice Study Guide, Newport, RI, 1990.

Naval Justice School Staff Judge Advocate's Handbook, Newport, RI, 1989.

Standardization of General Courts-Martial and Special Courts-Martial Records of Trial, JAGINST 5813.1, Office of the Judge Advocate General, Alexandria, VA, 1983.

Chapter 3

Alcohol and Drug Abuse Prevention and Control, OPNAVINST 5350.4B, Chief of Naval Operations, Washington, DC, 1990.

Manual for Courts-Martial (MCM), United States, 1984.

Manual of the Judge Advocate General (JAGMAN), JAGINST 5800.7C, Office of the Judge Advocate General, Alexandria, VA, 1991.

Naval Justice School Commander Handbook, Newport, RI, 1991.

Naval Justice School Evidence Study Guide, Newport, RI, 1990.

Naval Justice School Military Justice Study Guide, Newport, RI, 1990.

Naval Justice School Staff Judge Advocate's Handbook, Newport, RI, 1989.

Chapter 4

Manual for Courts-Martial (MCM), United States, 1984.

Manual of the Judge Advocate General (JAGMAN), JAGINST 5800.7C, Office of the Judge Advocate General, Alexandria, VA, 1991.

Naval Justice School Commander Handbook, Newport, RI, 1991.

Naval Justice School Evidence Study Guide, Newport, RI, 1990.

Naval Justice School Military Justice Study Guide, Newport, RI, 1990.

Naval Justice School Staff Judge Advocate's Handbook, Newport, RI, 1989.

Chapter 5

Department of the Navy Clemency and Parole Review, SECNAVINST 5815.3G, Office of the Secretary of the Navy, Washington, DC, 1985.

Department of the Navy Corrections Manual, SECNAVINST 1640.9A, Office of the Secretary of the Navy, Washington, DC, 1993.

Manual for Courts-Martial (MCM), United States, 1984.

Manual of the Judge Advocate General (JAGMAN), JAGINST 5800.7C, Office of the Judge Advocate General, Alexandria, VA, 1991.

Naval Justice School Commander Handbook, Newport, RI, 1991.

Naval Justice School Military Justice Study Guide, Newport, RI, 1990.

Naval Justice School Staff Judge Advocate's Handbook, Newport, RI, 1989.

Chapter 6

Department of the Navy Clemency and Parole Review, SECNAVINST 5815.3G, Office of the Secretary of the Navy, Washington, DC, 1985.

Department of the Navy Corrections Manual, SECNAVINST 1640.9A, Office of the Secretary of the Navy, Washington, DC, 1993.

Manual for Courts-Martial (MCM), United States, 1984.

Manual of the Judge Advocate General (JAGMAN), JAGINST 5800.7C, Office of the Judge Advocate General, Alexandria, VA, 1991.

Naval Justice School Commander's Handbook, Newport, RI, 1991.

Naval Justice School Military Justice Study Guide, Newport, RI, 1990.

Naval Justice School Staff Judge Advocate's Handbook, Newport, RI, 1989.

Chapter 7

Drugs of Abuse 1989, U.S. Department of Justice, Drug Enforcement Administration, Washington, DC, 1989.

Manual for Courts-Martial (MCM), United States, 1984.

Chapter 8

- Ammunition Afloat*, NAVSEA OP-4, Commander Naval Sea Systems Command, Washington, DC, 1972.
- Ammunition Ashore*, Volume 1, NAVSEA OP-5, Commander Naval Sea Systems Command, Washington, DC, 1990.
- Machine Gun, 7.62-MM, M60*, Department of the Army Technical Manual TM 9-1005-224-10, Headquarters, Department of the Army, Washington, DC, 1985.
- Machine Gun, 7.62-MM, M60*, Department of the Army Technical Manual TM 9-1005-224-24, Headquarters, Department of the Army, Washington, DC, 1987.
- Military Shotgun, 12 Gauge, Pump Action, Model 870*, Department of the Air Force TO 11W3-6-2-1, Secretary of the Air Force, Washington, DC, 1972.
- Navy Gun Ammunition*, NAVSEA SW030-AA-MM0-010, Commander Naval Sea Systems Command, Washington, DC, 1985.
- Physical Security and Loss Prevention Manual for Conventional Arms, Ammunition, and Explosives*, OPNAVINST 5530.13A, Office of the Chief of Naval Operations, Washington, DC, 1991.
- Pistol, Caliber .45, Automatic, M1911A1*, Department of the Army Technical Manual TM 9-1005-211-12, Headquarters, Department of the Army, Washington, DC, 1968.
- Revolver, Caliber .38 Special: Smith and Wesson Military and Police, M10*, Department of the Army Technical Manual TM 9-1005-206-14&P-1, Headquarters, Department of the Army, Washington, DC, 1985.
- Rifle, 7.62-MM, M14*, Department of the Army Technical Manual TM 9-1005-223-10, Headquarters, Department of the Army, Washington, DC, 1972.
- Rifle, 7.62-MM, M14*, Department of the Army Technical Manual TM 9-1005-223-20, Headquarters, Department of the Army, Washington, DC, 1972.
- Rifle, 5.56-MM, M16*, Department of the Army Technical Manual TM 9-1005-249-10, Headquarters, Department of the Army, Washington, DC, 1985.
- 40-MM Grenade Launcher M79*, Department of the Army Technical Manual TM 9-1010-205-10, Headquarters, Department of the Army, Washington, DC, 1985.
- 40-MM Grenade Launcher M79*, Department of the Army Technical Manual TM 9-1010-205-24, Headquarters, Department of the Army, Washington, DC, 1972.
- United States Navy Ammunition, Historical and Functional Data*, NAVSEA SW010-AB-GTP-010, Commander Naval Sea Systems Command, Washington, DC, 1981.
- United States Navy Ordnance Safety Precautions*, NAVSEA OP-3347, Commander Naval Sea Systems Command, Washington, DC, 1972.
- Use of Deadly Force and the Carrying of Firearms by Personnel of the Department of the Navy in Conjunction with Law Enforcement, Security Duties, and Personal Protection*, SECNAVINST 5500.29B, Office of the Secretary, Washington, DC, 1992.

Chapter 9

Civil Disturbances, Department of the Army Field Manual, FM 19-15, Headquarters, Department of the Army, Washington, DC, 1985.

Military Support of Civil Defense, Department of Defense Directive 3025.10, Washington, DC, 1981.

Use of Deadly Force and the Carrying of Firearms by Personnel of the Department of the Navy in Conjunction with Law Enforcement, Security Duties, and Personal Protection, SECNAVINST 5500.29B, Office of the Secretary, Washington, DC, 1992.

Chapter 10

Navy Luck and Key Control Guide (Ashore), Department of the Navy, June 1988, Naval Civil Engineering Laboratory, Code L56, Port Hueneme, CA., June 1988.

Physical Security and Loss Prevention Manual, OPNAVINST 5530.14B, Office of the Chief of Naval Operations, Washington, DC, 1991.

Chapter 11

Military Working Dog Manual, OPNAVINST 5585.2A, Office of the Chief of Naval Operations, Washington, DC, 1992.

Chapter 12

Navy Law Enforcement Manual, OPNAVINST 5580.1, Office of the Chief of Naval Operations, Washington, DC, 1986.

Chapter 13

Customs Inspection, OPNAVINST 5840.3B, Office of the Chief of Naval Operations, Washington, DC, 1993.

Chapter 14

Department of the Navy Corrections Manual, SECNAVINST 1640.9A, Office of the Secretary of the Navy, Washington, DC, 1993.

Navy Law Enforcement Manual, OPNAVINST 5580.1, Office of the Chief of Naval Operations, Washington, DC, 1986.

Navy Military Funerals, NAVPERS 15555B, Naval Personnel Command, Washington, DC, 1986.

Program for Prisoners of War and other Detainees, SECNAVINST 3641.3, Office of the Secretary, Washington, DC, 1973.

Standard Organization and Regulations of the U.S. Navy, OPNAVINST 3120.32B, Chief of Naval Operations, Washington, DC, 1986.

United States Navy Regulations, Office of the Secretary, Washington, DC, 1990.

Chapter 15

Navy Law Enforcement Manual, OPNAVINST 5580.1, Office of the Chief of Naval Operations, Washington DC, 1986.

Criminal and Security Investigations Within the Department of the Navy, SECNAVINST 5520.3, Office of the Secretary, Washington, DC, 1993.

Chapter 16

Law Enforcement Investigations, Department of the Army Field Manual, FM 19-20, Headquarters, Department of the Army, Washington, DC, 1985.

Navy Law Enforcement Manual, OPNAVINST 5580.1, Office of the Chief of Naval Operations, Washington, DC, 1986.

Chapter 17

Navy Law Enforcement Manual, OPNAVINST 5580.1, Office of the Chief of Naval Operations, Washington, DC, 1986.

Chapter 18

Drill and Ceremonies Manual and Interior Guard Manual, SECNAVINST 5060.22, Office of the Secretary, Washington, DC, 1981.

Flags, Pennants, and Customs, NTP 13(B), Commander, Naval Telecommunications Command, Washington, DC, 1986.

Navy Law Enforcement Manual, OPNAVINST 5580.1, Office of the Chief of Naval Operations, Washington, DC, 1986.

Navy Reports and Forms Preparation, Guide for the Naval Security Force, CNO N09N/NIS-24, Code 24/X32B, Washington, DC, 1991.

INDEX

A

Action by the inventory board, 14-9

articles injurious to personnel, 14-8

classified material, 14-9

inventory of valuables, 14-9

objectionable material, 14-9

Admissibility of evidence, 4-6

authenticity, 4-6

competency, 4-6

relevancy, 4-6

Advice to accused—counsel, 5-5

Advice to accused—rights, 5-4

Alternative voluntary restraint, 1-21

Amphetamines, 7-27

Anabolic steroids, 7-36

abuse of steroids, 7-37

black market for steroids, 7-38

characteristics of steroids, 7-37

definition of steroids, 7-36

medical use of steroids, 7-37

psychological effects of steroids, 7-37

signs of steroid use, 7-38

steroid use, 7-37

steroids and the *UCMJ*, 7-37

Applicability of the rules of evidence, 4-2

Application of force, 9-8

authorization for deadly force, 9-9

briefing of personnel, 9-8

paramount principle, 9-8

policies regarding the use of deadly force, 9-10

the right of self defense, 9-9

use of nondeadly and deadly force, 9-9

vital facilities, 9-10

Apprehending drug violators, 7-42

apprehension, 7-42

search, 7-44

Apprehension, 2-9

evaluation, 2-9

taking into custody, 2-10

two-person approach, 2-9

when to apprehend, 2-9

Apprehension and restraint, 12-21

chemical aerosol irritant projectors, 12-23

firearms, 12-22

handcuffs, 12-22

police baton, 12-23

use of equipment, 12-22

use of force, 12-21

Apprehension and restraint, 2-6

apprehension, 2-9

Article 7—apprehension, 2-6

Article 8—apprehension of deserters

Article 9—imposition of restraint, 2-7

Article 10—restraint of persons charged with offenses, 2-8

Article 11—reports and receiving of prisoners, 2-8

Article 12—onfiement with enemy prisoners prohibited, 2-8

Article 13—punishment prohibited before trial, 2-8

citizen's right to arrest, 2-10

when to apprehend, 2-9

Article 31,2-11

Article 31a, 2-11

Article 31b, 2-12

Article 31c, 2-12

Article 31d, 2-12

Articles 77 through 134 of *UCMJ*, Appendix III
Assimilative Crimes Act, 2-3
 territorial jurisdiction, 2-4
Authority of law enforcement personnel, 15-42
Automatic and semiautomatic firing systems, 8-3
 blowback-operated, 8-3
 gas-operated weapons, 8-3
 range and rate of fire, 8-4
 recoil-operated weapons, 8-3

B

Badge expiration dates, 10-16
 contractor picture badges, 10-16
 military permanent badges, 10-16
 permanent picture badges, 10-16

Barbiturates, 7-20
 benzodiazepines, 7-21
 glutethimide, 7-21
 meprobamate, 7-21

Bloodstain evidence, 16-29
 bleeding, 16-29
 handling evidence, 16-31
 laboratory examination, 16-32
 marking evidence, 16-31
 role of the investigator, 16-31
 shape, persistency, and age, 16-30
 source, 16-31
 transmittal of evidence, 16-32

Body views and intrusions, 3-11

Burial at sea, 14-5
 eligibility for burial at sea, 14-5
 preparation for the burial at sea ceremony, 14-6
 responsibility for preparation of remains, 14-6

C

Cannabis, 7-33
 hashish, 7-36

Cannabis—Continued
 hashish oil, 7-36
 marijuana, 7-33

Care of the uniform, 1-24
 government-owned uniforms, 1-24
 organizational clothing, 1-24
 transfer of uniforms, 1-24
 uniform stencils, 1-24

Casts and molds, 16-11

Casual civilian attire, 1-33
 civilian clothes in foreign countries, 1-34
 civilian clothing, 1-33
 drug avocation prohibited, 1-34
 wearing uniform articles with civilian clothes,
 1-34

Categorization of Navy uniforms, 1-22
 classes of uniforms 1-22
 types of uniforms, 1-22

Categorization of searches, 3-3

Chain of custody, 17-3
 evidence custodian, 17-3
 responsibility, 17-3

Characteristics of small arms, 8-1
 automatic and semiautomatic firing systems, 8-3
 grenade launchers, 8-23
 M16A1 rifle, 8-13
 M1911A1.45-caliber pistol, 8-5
 Mossberg M500 shotgun, 8-19
 Remington M870 shotgun, 8-15
 7.62-MM M60 machine gun, 8-19
 shoulder weapons, 8-9
 the .38-caliber revolver, 8-8

Circumstances permitting increased punishments,
 5-22
 three or more convictions, 5-22
 two or more convictions, 5-23
 two or more offenses, 5-23

- Circumstantial evidence, 4-5
 - admissible circumstantial evidence, 4-5
 - inadmissible circumstantial evidence, 4-5
- Citizen's right to arrest, 2-10
 - military necessity, 2-10
 - permission to apprehend, 2-10
 - personal liability defenses, 2-10
 - superior orders, 2-11
- Civil court liaison, 5-27
- Civil disturbances, 9-1
 - executive agent, 9-1
 - intervention, 9-1
- Clemency and corrective action on review, 6-27
 - authority to act, 6-27
 - forms of action, 6-28
 - mitigation, 6-28
 - remission, 6-28
 - setting aside, 6-28
 - suspension, 6-28
- Collective behavior, 9-1
 - civil disturbances, 9-2
 - crowds, 9-2
 - mobs, 9-2
- Combination of NJP punishments, 6-27
 - acceptable combinations, 6-27
 - unacceptable combinations, 6-27
- Command investigators, 15-2
- Command key control, 10-4
 - central key room, 10-5
 - key centers, 10-5
 - key control officer 10-4
 - key custodian, 10-5
 - key subcustodians, 10-5
 - lock control seals, 10-5
 - lockouts, 10-5
- Command relationship to drug abuse, 7-1 A
 - maximum punishments for controlled substances, 7-2
- Communications, 12-5
 - base station, 12-6
 - call signs, 12-6
 - code, response codes, and phonetic alphabet, 12-7
 - federal communications commission (FCC), 12-6
 - mobile two-way radio sets, 12-6
 - net organization, 12-6
 - plain language communication, 12-6
 - standard 10-code communication, 12-6
 - transmission procedures, 12-6
- Community/human relations, 12-4
 - community relations procedures, 12-5
 - rules of conduct, 12-5
- Competency, 4-6
 - public policy, 4-7
 - reliability, 4-7
 - undue prejudice, 4-7
- Composition of the special court-martial, 5-9
 - military judge alone, 5-9
 - military judge and members, 5-9
 - three members, 5-9
- Conducting interviews, 15-31
 - estimate of information sought, 15-31
 - evaluating information received, 15-33
 - familiarity with the background of the interviewee, 15-31
 - familiarity with the case, 15-31
 - introduction and identification, 15-32
 - opening statement, 15-32
 - planning interview, 15-32
 - quality control, 15-34
 - the interview, 15-32

- Consent searches, 3-9
- Constitution of the court, 5-10
 - commissioned officers, 5-10
 - enlisted members, 5-10
 - qualifications of members, 5-10
 - qualifications of the military judge, 5-10
- Constitutional considerations, 2-11
 - fifth amendment rights, 2-11
 - preinterrogation warnings, 2-11
- Contents of NJP appeal package, 6-30
 - accused's acknowledgement of appeal rights, 6-31
 - accused's endorsement, 6-34
 - appellant's letter, 6-30
 - contents of forwarding endorsements, 6-33
 - endorsement of the reviewing authority, 6-34
 - return endorsement of via addresses, 6-34
 - sample NJP letter of appeal, 6-32
 - sample first endorsement to NJP appeal, 6-33
 - style of letter, 6-31
- Control of crowds or mobs, 9-11
 - conversion from crowd to mob, 9-12
 - crowd control options, 9-12
 - distinction between crowds and mobs, 9-12
 - variables of crowds or mobs, 9-11
- Control of personnel, 10-15
 - badge expiration dates, 10-16
 - key cards, 10-17
 - pass and badge characteristics, 10-17
 - pass and badge standards, 10-16
 - personnel identification systems, 10-15
 - standard re-badging, 10-16
- Control of vehicles, 10-17
 - application of decals in overseas areas, 10-17
 - exemption for naval criminal investigative service, 10-6
 - honoring of vehicle identification, 10-18
- Control of vehicles—Continued
 - special precautions, 10-18
 - visitor control, 10-18
- Corpus delicti, 4-2
 - drunkenness, 4-3
 - intent, 4-3
 - negligence, 4-3
 - presumption of innocence, 4-3
- Correct wear of the uniform, 1-24
- Courses of mob action, 9-5
- Court bailiff, 5-24
 - conduct of bailiff, 5-26
 - duties of the bailiff, 5-24
 - services of bailiff, 5-26
- Court proceedings, 4-8
 - attendance of witnesses, 4-9
 - order of evidence, 4-9
 - who may testify, 4-9
- Courts-martial punishments, 5-19
 - authorized punishments, 5-20
 - bad-conduct discharge, 5-20
 - confinement, 5-20
 - confinement on bread and water/diminished rations, 5-21
 - fine, 5-22
 - forfeiture of pay, 5-21
 - hard labor without confinement, 5-21
 - loss of numbers, 5-22
 - punitive reprimand, 5-22
 - reduction in grade, 5-22
 - restriction, 5-21
 - authorized punishments, 5-20
- Creation of the special court-martial, 5-9
- Creation of the summary court-martial, 5-1
 - jurisdictional limitations: offenses, 5-2
 - jurisdictional limitations: persons, 5-2

- Creation of the summary court-martial—Continued
 - mechanics of convening, 5-2
 - restrictions on authority to convene, 5-1
 - summary court-martial officer, 5-2
- Credentials and badges, 15-4
- Crime prevention, 18-4
 - definitions, 18-4
 - factors of crime, 18-4
 - prevention of specific crimes and offenses, 18-5
- Crime prevention survey, 18-5
 - relationship of crime prevention surveys to physical security inspections, 18-5
 - subjects of surveys, 18-5
 - survey techniques and procedures, 18-7
- Crime scene photography, 16-53
 - basic photography information, 16-54
 - color photography, 16-55
 - filter uses, 16-55
 - general considerations, 16-53
 - infrared and ultraviolet photography, 16-55
 - special considerations, 16-53
- Crime scene processing, 16-44
 - collecting evidence, 16-47
 - crime scene procedure, 16-44
 - general evidence processing, 16-48
 - marking evidence for identification, 16-47
 - recording, 16-45
 - searching for evidence 16-45
- Criminal information and intelligence operations, 15-4
 - definitions, 15-4
 - essential elements of criminal information (EECI), 15-5
 - laws, 15-6
 - operational information, 15-5
 - other criminal information requirements (OCIR), 15-5
- Criminal information and intelligence operations—Continued
 - police information, 15-5
 - responsibilities, 15-5
 - source of information, 15-5
 - systems of records, 15-6
- Criminal information process, 15-5
 - analysis, 15-6
 - collation, 15-6
 - dissemination, 15-6
 - evaluating criminal information, 15-6
 - planning and collecting, 15-5
 - reporting, 15-6
- Cross-examination, 4-13
- Crowd and mob control formations, 9-15
 - formation interval, 9-17
 - types of formations, 9-16
- Crowd control options, 9-12
 - blocking, 9-12
 - containing, 9-12
 - dispersing, 9-12
 - monitoring, 9-12
- Crowd control techniques, 9-13
 - apprehension of crowd members, 9-14
 - channelization, 9-13
 - communication of interest and intent, 9-13
 - cooperation, 9-13
 - diversion, 9-13
 - employment of water, 9-14
 - military working dogs, 9-15
 - observation, 9-13
 - photography, 9-15
 - proclamation, 9-13
 - riot control agents, 9-14
 - show of force, 9-14
 - use of barriers, 9-14

Cycles of operation, 8-1

 cambering, 8-2

 cocking, 8-2

 ejecting, 8-2

 extracting, 8-2

 feeding, 8-1

 firing, 8-2

 locking, 8-2

 unlocking, 8-2

D

Deliriant and other abused substances, 7-38

Demeanor on witness stand, 5-23

Depositions and affidavits, 4-10

Depressants, 7-19

Description techniques, 15-15

 events, 15-19

 general characteristics, 15-15

 general characteristics, 15-17

 objects, 15-17

 persons, 15-15

 places, 15-18

 specific characteristics, 15-15

 specific characteristics, 15-18

Designer drugs, 7-38

Disestablishment of the court, 5-11

 additional charges, 5-11

 amendment of charges, 5-11

 change in court: no disestablishment, 5-11

Distribution, 7-10

 dispensing to patients, 7-10

 prescription drugs, 7-10

 security, 7-10

Documentary evidence, 4-3

 General requirements for documentary evidence,
 4-4

 letters, telegrams, and photographs, 4-4

 records and registers, 4-4

DOD-sponsored cargo, 13-6

 entry procedures, 13-7

 inspection/examination procedures, 13-6

Drug abuse and aids, 7-46

 drug abuse statistics, 7-46

 needle sharing, 7-46

 Non-IV drug use and AIDS, 7-47

 sexual transmission, 7-46

 transmission, 7-46

Drug abuse detection, 3-14

 fitness-for-duty testing, 3-16

 search and seizure, 3-15

 service-directed testing, 3-16

 the collection process, 3-17

 the urinalysis program, 3-14

 the use of drug-detector dogs, 3-12

 urinalysis inspections under MRE 313, 3-16

 uses of urinalysis results, 3-17

 valid medical purposes, 3-16

Drug characteristics, 7-11

 amphetamines, 7-27

 anabolic steroids, 7-36

 barbiturates, 7-20

 controlled substances; uses and effects, 7-13

 deliriant and other abused substances, 7-38

 depressants, 7-19

 designer drugs, 7-38

 hallucinogens, 7-29

 look-alikes, 7-38

 methamphetamine, 7-27

 phencyclidine and related drugs, 7-32

 semisynthetic Narcotics, 7-16

 stimulants, 7-21

 synthetic narcotics, 7-18

Drug terminology, 7-3

- casual supplier, 7-5
- central nervous system, 7-3
- controlled substances, 7-3
- convulsions, 7-3
- dangerous drugs, 7-3
- delirium, 7-3
- depressant, 7-3
- drug abuse, 7-3
- drug abuser, 7-4
- drug addict (hard core), 7-4
- drug dependence, 7-4
- drug experimenter, 7-4
- drug user spree, 7-4
- habituation, 7-4
- hallucinogen, 7-3
- hypnotic, 7-3
- narcotics, 7-3
- physical dependence, 7-4
- potentiation, 7-4
- psychological dependence, 7-4
- psychosis, 7-4
- sedative, 7-3
- side effects, 7-4
- stimulant, 7-3
- supplier, 7-5
- tolerance, 7-4
- toxic effects (poisoning), 7-4

Drugs offenses, 7-42

- direct purchase, 7-42
- informant purchase, 7-42
- investigative considerations, 7-42

Duties and responsibilities of the CMAA, 14-1

- publications, 14-1
- safety, 14-1
- training, 14-1

Duties and responsibilities of the Master-at-Arms force, 14-2

- liberty parties, 14-3
- routine duties, 14-2
- visiting, 14-3

E

Emergencies, 14-4

Emergency searches to save life of for related purposes, 3-11

Entering and leaving port, 14-4

Evacuation of civilians, 14-10

embarkation-debarkation, 14-10

general plans, 14-10

responsibilities, 14-10

Evidence depositories, 17-4

combination control, 17-5

disposition of evidence, 17-8

inventories, 17-5

methods of transmittal to a forensic laboratory, 17-6

preparation and transmittal of evidence, 17-6

submitting evidence to a laboratory, 17-6

temporary depositories, 17-5

transfer and shipment of evidence, 17-5

wrapping, packaging, and transmitting, 17-6

Evidence forms and records, 17-3

active and final disposition file, 17-4

evidence log, 17-3

evidence/property custody document, 17-3

evidence tags, 17-3

Examination procedure, 4-11

cross-examination, 4-13

double questions, 4-11

forbidden questions, 4-12

leading questions, 4-11

notes, 4-12

Examination procedure—Continued

- opinions, 4-12
- verification of testimony, 4-12
- weighing evidence, 4-12

Execution of NJP punishments, 6-26

- deferrel of correctional custody or confinement on bread and water or diminished rations, 6-26
- deferral of restraint punishments pending NJP appeal, 6-26
- interruption of punishment by unauthorized absence (UA), 6-27
- interruptions of restraint punishment by subsequent NJP, 6-26

Execution of the ship's routine, 14-2

Executive officer's (XO's) screening, 6-20

Extension of working hours, 1-20

Extra military instruction, 1-19

- authority, 1-20
- Implementation, 1-19

F

Factors that affect crowd behavior, 9-4

- crowd leadership, 9-4
- emotional needs, 9-4
- external controls, 9-4
- moral attitudes, 9-4
- the use of physical stimuli, 9-4

Federal laws concerning drugs, 7-5

- formal scheduling, 7-5

Fentanyl analogues, 7-18

- characteristics of fentanyls, 7-19
- effects of fentanyls, 7-19
- pharmacological effects, 7-19

Finding and processing prints, 16-4

- chemical processing, 16-7
- finding fingerprints, 16-4
- lifting fingerprints, 16-6
- powdering, 16-5

Fingernail scrapings, 16-36

- procedures for taking fingernail scrapings, 16-36

Fingerprinting, 16-1

- bifurcation, 16-1
- classification and identification, 16-11
- classification designation, 16-9
- core, 16-1
- delta 16-1
- divergence, 16-1
- focal points, 16-1
- latent print, 16-1
- maintenance of fingerprint records, 16-11
- major case prints, 16-1
- palmar, 16-1
- pattern area, 16-1
- patterns and classifications, 16-9
- plantar, 16-1
- point, 16-1
- record prints, 16-1
- ridge, 16-1
- shoulders, 16-1
- type lines, 16-1

Firearms and ammunition, 13-17

Fixed surveillance, 15-27

- other techniques, 15-27

Foot surveillance 15-25

Formal scheduling, 7-5

- controlled substance analogues, 7-8
- emergency or temporary scheduling, 7-7
- international treaty obligations, 7-8
- Schedule I, 7-6
- Schedule II, 7-6
- Schedule III, 7-7
- Schedule IV, 7-7
- Schedule V, 7-7

Formation weapons and carry positions, 9-17

positions for weapons, 9-19

riot control agents, 9-17

the riot baton, 9-17

the riot shotgun, 9-17

Forms of evidence, 4-3

demonstrative evidence, 4-5

documentary evidence, 4-3

oral evidence, 4-3

real evidence, 4-4

Fundamentals of graphic and tabular charts, 18-10

curve chart, 18-10

frequency distribution table, 18-11

pie (sector) chart, 18-11

spot map, 18-11

vertical bar (column) chart, 18-11

G

General courts-martial-trial proceedings, 5-19

the death penalty, 5-19

the defense counsel, 5-19

the military judge, 5-19

who may be tried, 5-19

who may serve, 5-19

General provisions of military customs inspections,
13-1

policy, 13-2

General regulations, 1-10

alarm bells and the general announcing system,
1-10

alcohol, 1-10

armed forces identification cards and leave
papers, 1-10

arrest by civil authorities, 1-11

berthing, 1-11

card games and gambling, 1-11

civilian clothing, 1-11

General regulations-Continued

concessions, 1-11

contagious and communicable diseases, 1-11

crew's head and washrooms, 1-12

customs, 1-12

discharge of oil, trash, and garbage, 1-16

divine services, 1-12

electrical and electronic equipment, 1-12

emergency equipment, 1-12

false statements, 1-12

freshwater, 1-12

government property, 1-13

health, sanitation, and messing, 1-13

hitchhiking, 1-13

inspection of property, 1-13

intoxicated persons, 1-13

leave and liberty, 1-13

lights, 1-14

locked spaces, 1-14

mess gear, 1-14

motor vehicles, 1-14

narcotics and other controlled substances, 1-14

official forms, records, and correspondence, 1-14

outfits, uniforms, and clothing, 1-15

personal effects, 1-15

personally owned tools and materials, 1-15

petitions, protest and dissident and related
activities, 1-15

pets, 1-16

photographic equipment, 1-16

plan of the day, 1-16

profane language, 1-16

removal of equipment from ship, 1-17

restricted spaces, 1-17

sabotage or willful damage, 1-17

shipboard traffic routes, 1-17

General regulations—Continued

- small arms, 1-17
- swimming, 1-17
- tampering, 1-17
- tax-free tobacco products, 1-18
- tipping, 1-18
- unauthorized alterations, 1-18
- unauthorized articles, 1-18
- unauthorized entry, 1-18

Glass fractures, 16-17

- collecting and handling, 16-17
- collection, 16-18
- marking, 16-18
- nature of glass, 16-17
- preservation, 16-19
- properties of glass, 16-17
- records, 16-18

Grenade launchers, 8-23

- controls of the M79 grenade launcher, 8-24
- 40-MM M79 Grenade launcher, 8-23
- operating the M79 grenade launcher, 8-24

Grooming Standards, 1-29

- beards and mustaches, 1-30
- civilian clothing, 1-33
- earrings, 1-31
- glasses, 1-33
- hair (women), 1-31
- Hair (men), 1-29
- hairpieces, 1-30
- necklaces/chokers, 1-31
- personal appearance (men), 1-29
- personal appearance (women), 1-31
- sideburns, 1-30
- undergarments, 1-33
- wristwatches/bracelets, 1-31

H

Hairs and fibers, 16-34

- fiber examination 16-35
- fibers, 16-35
- hair, 16-34
- hair examination, 16-34
- handling and transmittal, 16-35

Hallucinogens, 7-29

- bufotenin, 7-32
- diethyltryptamine, 7-32
- dimethyltryptamine, 7-32
- DOM, 7-32
- LSD (LSD-25, lysergide), 7-30
- mescaline, 7-31
- methylenedioxyamphetamine, 7-32
- psilocybin and psilocyn, 7-31

Handguns, 8-5

- M1911A1.45-caliber pistol, 8-5
- the .38-caliber revolver, 8-8

Hearsay evidence, 4-8

- dying declarations, 4-8
- res gestae, 4-8

Human factors, 15-28

- fear of self-involvement, 15-29
- inconvenience, 15-29
- investigator-interviewee personality conflicts, 15-29
- perception and memory, 15-28
- prejudice, 15-29
- reluctance to talk, 15-29
- resentment toward police and police methods, 15-29

I

I division, 14-2

Identification of illicit laboratories, 7-40

- labs by reagents present, 7-41

- IDS equipment description, 10-19
 - annunciator, control, and display subsystem, 10-20
 - data transmission subsystem, 10-20
 - exterior sensors, 10-20
 - interior sensors, 10-20
 - operating power requirements, 10-20
 - sensor subsystem, 10-20
- IDS policy, 10-20
 - contractor qualifications, 10-21
 - emergency power, 10-21
 - IDS for OPNAV/CMC-designated sites, 10-21
 - installation, 10-21
 - maintenance, 10-22
 - MILCON IDSS, 10-21
 - proprietary type of IDS, 10-21
 - supply support, 10-22
 - training, 10-22
- Informants, 15-7
 - informant control, 15-10
 - informant management, 15-9
 - investigator compromise by informants, 15-10
 - juvenile informants, 15-10
 - legal status of informant information, 15-11
 - meeting with informants, 15-11
 - motives of informants 15-8
 - selection of informants, 15-7
 - treatment of informants, 15-11
- Initiation and reporting of investigations, 15-3
- Inspections, 14-4
- Inspections and inventories, 3-13
 - inspections, 3-13
 - inventories, 3-14
- Internal investigation management, 15-47
 - operational management, 15-47
 - utilization of personnel, 15-47
- International treaty obligations, 7-8
- Interpreters, 15-39
 - choosing an interpreter, 15-39
 - controlling the interpreter, 15-39
 - questioning procedure, 15-40
- Interrogating suspects, 15-34
 - classifying suspects, 15-35
 - planning the interrogation, 15-34
- Interviews and interrogation, 15-27, 15-46
 - definitions, 15-28
 - human factors, 15-28
 - legal considerations, 15-28
- Interviews/interrogations of members of the opposite sex, 15-29
- Intrusion detection systems, 10-18
 - IDS employment factors, 10-19
 - types of intrusion detection systems, 10-19
- Investigation of crimes that violate military and federal criminal law, 15-1
 - major criminal offenses, 15-2
 - minor criminal offenses, 15-2
- Investigation of juvenile offenders, 15-40
 - definitions, 15-41
- Investigative jurisdiction, 2-3, 15-1
 - Assimilative Crimes Act, 2-3
 - major crimes, 2-3
 - minor crimes and traffic offenses, 2-3
- Investigative procedures, 15-45
 - basic principles, 15-45
 - preliminary investigation, 15-45
- Investigator examination of glass fractures, 16-19
 - fractures caused by heat, 16-21
 - fractures made with a blunt instrument or object, 16-20
 - general examination, 16-19
 - paint spots on glass, 16-20
 - reconstruction of fractured glass, 16-21
 - safety glass, 16-20

J

Jurisdiction, 2-1, 15-41

- Assimilative Crimes Act, 2-3
- constitutional considerations, 2-11
- federal jurisdiction, 15-41
- investigative jurisdiction, 2-3
- jurisdiction over location or place, 2-2
- jurisdiction over the offense, 2-2
- jurisdiction over the person, 2-2
- military jurisdiction, 15-41
- overseas installations, 15-42
- sources of jurisdiction, 2-1
- state jurisdiction, 15-42
- types of jurisdiction, 2-2
- fifth amendments rights, 2-11

Jurisdiction over the person, 3-4

- civilians, 3-4
- military, 3-4

Jurisdictional maximum punishment, 5-23

Juvenile Justice and Delinquency Prevention Act, 15-43

- apprehension, 15-43
- detainment, 15-43
- records, 15-43

Juvenile offenses, 15-44

- legal action, 15-44
- types of offenses, 15-44

L

Laboratory examination, 16-16, 16-22

- density, 16-23
- fluorescence, 16-23
- glass fractures, 16-23
- glass fragments, 16-23
- refractive index, 16-23
- spectrographic Analysis, 16-23
- transmittal to laboratory, 16-23

Laundry and dry-cleaning marks, 16-29

- examination, 16-29
- tracing a mark, 16-29

Leadership, 1-18

- petty officer authority, 1-18

Limited waterway areas, 10-10, 10-11

Logistical support to the U.S. secret service (USSS), 11-7

- transportation, 11-8
- uniforms, 11-8
- weapon requirements, 11-8

M

M14 rifle, 8-10

- firing the M14 rifle, 8-12
- M14 rifle controls, 8-10
- unloading the M14 rifle, 8-12

M16A1 rifle, 8-13

- clearing the M16A1 rifle, 8-13
- gun maintenance, 8-15
- loading the magazine, 8-14
- loading the rifle, 8-14
- unloading the rifle, 8-15

M1911A1.45-caliber pistol, 8-5

- assembly, 8-7
- cycle of operation, 8-7
- disassembly, 8-5
- general disassembly (field-stripping), 8-6
- safeties, 8-7

Major criminal offenses, 15-2

Management of civil disturbances, 9-6

- importance of communications, 9-7
- interim objective, 9-6
- ultimate objective, 9-6

Maritime waterway and security zone jurisdiction, 2-4

Marksmanship, 8-28

- aiming, 8-28

- Marksmanship—Continued
 - qualifications, 8-29
 - training, 8-28
 - trigger control, 8-29
- Master-at-Arms duties at courts-martial, and courts of inquiry, 5-24
 - court bailiff, 5-24
 - guarding prisoners, 5-24
- Mental preparation for civil disturbances operations, 9-20
 - individual response to stress, 9-20
 - psychological influences, 9-20
- Methamphetamine, 7-27
 - anorectic drugs, 7-29
 - crystal methamphetamine, 7-28
 - phenmetrazine (preludin) and methylphenidate (ritalin), 7-29
- Methods of patrol, 12-3
 - fixed posts, 12-4
 - foot patrols, 12-4
 - motor patrols, 12-4
- Methods of surveillance, 15-25
 - close surveillance, 15-25
 - combination of loose and close surveillance methods, 15-25
 - loose surveillance, 15-25
- Military customs inspection program, 13-2
 - aircraft, 13-12
 - clearance, 13-11
 - inspection procedures, 13-10
 - inspection requirements, 13-10
 - ships, 13-10
 - special procedures, 13-12
 - unscheduled landings, 13-12
- Minimum security measures, 10-8
 - general security measures, 10-9
 - level one security measures, 10-9
- Minimum security measures—ontinued
 - level three security measures, 10-8
 - level two security measures, 10-9
- Minor criminal offenses, 15-2
- Miscellaneous laboratory examinations, 16-39
 - gas-liquid chromatography, 16-40
 - infrared light, 16-39
 - spectrograph, 16-39
 - spectrophotometers, 16-40
 - ultraviolet light, 16-39
- Mob control techniques, 9-15
- Molding, 16-15
 - plaster of Paris, 16-16
 - positive moulage-agar compositions, 16-16
- Motives of informants, 15-8
 - demented, eccentric, or nuisance motives, 15-9
 - egotistical motives, 15-9
 - gratitude, 15-9
 - mercenary motives, 15-9
 - perverse motives, 15-9
 - reform motive, 15-9
 - revenge motives, 15-9
 - the fear motive, 15-8
- MWD Certification, 11-2
 - detector MWD teams, 11-2
 - MWD team training, 11-2
 - patrol MWD teams, 11-2
- MWD Duties and responsibilities, 11-1
 - composition of MWD teams, 11-1
 - kennel master, 11-1
 - MWD handler, 11-1
- MWD operational safety procedures, 11-7
- MWD search techniques, 11-5
- MWD team considerations, 11-9
- MWDS aboard ship, 11-3
 - berthing areas, 11-4

MWDS aboard ship—Continued

- considerations for detection in shipboard spaces, 11-4
- galleys/sculleries, 11-4
- long term use of MWD teams onboard ship, 11-4
- machinery, engine, and fire room spaces, 11-4
- movement below decks, 11-4
- storerooms, 11-4

N

Narcotics, 7-12

- codeine, 7-16
- morphine, 7-15
- narcotics, 7-12
- narcotics of natural origin, 7-14
- opium, 7-15
- thebaine, 7-16

Nature of the punishment, 6-24

- admonition and reprimand, 6-24
- arrest in quarters, 6-24
- confinement on bread and water or diminished rations, 6-26
- correctional custody, 6-26
- extra duty, 6-25
- forfeiture, 6-25
- limits of Punishments Under UCMJ, Article 15, 6-25
- reduction in grade, 6-26
- restriction, 6-24
- sample letter of orders to carry out NJP punishment of extra duty, 6-38
- sample letter of instructions for carrying out punitive restriction, 6-39

NJP appeal, 6-30

- procedure, 6-30
- request for stay of restraint or extra duty, 6-30
- time, 6-30

NJP authorized punishments, 6-24

- limitations, 6-24

NJP for officers, 6-37

NJP log entries, 6-37

- nature and requirements for nonjudicial punishment (NJP), 6-1

- sample letter of orders to carry out NJP punishment of extra duty, 6-38

- sample letter of instructions for carrying out punitive restriction, 6-39

- who may impose 6-1

Nonjudicial punishment, courts-martial, and courts of inquiry, 14-5

Nonnarcotic drug abuse, 7-2

Nonpunitive censure, 1-21

O

Objects of a search or seizure, 3-3

Observation, description, and identification, 15-13

Observation, description, and identification by witnesses, 15-19

- absence or presence of distracting events or circumstances, 15-19

- composite photographs and sketches, 15-22

- description, 15-21

- experiences, 15-20

- human factors, 15-19

- identification, 15-21

- lapse of time since the observation was made, 15-19

- location of witness at time of observation, 15-19

- observation, 15-19

- physiological influences, 15-20

- psychological influences, 15-20

- training, 15-21

- use of an artist, 15-22

- weather and light conditions, 15-19

Observation techniques, 15-13

- events, 15-14

Observation technique—Continued

indoors, 15-14

objects, 15-13

outdoors, 15-14

persons, 15-13

places, 15-14

Offenses punishable under Article 15, *UCMJ*, 6-3

cases previously tried in civil court, 6-4

circumstances surrounding the commission of an offense, 6-3

maximum penalty, 6-3

off-base offenses, 6-4

Official and personal mail, 13-7

bona fide gifts, 13-10

customs declaration procedures, 13-7

former government property, 13-10

official mail, 13-7

personal mail, 13-7

personal property, 13-10

Official publications, and directives, 18-14

Corrections Manual, 18-15

Department of the Navy Information and Personnel Security Program Regulation, OPNAVINST 5510.1, 18-15

Flags, Pennants and Customs, NTP 13, 18-15

Manual for Courts-Martial, United States, 1984 (MCM), 18-14

Manual of the Judge Advocate General (JAGMAN), JAGINST 5800.7, 18-14

Navy Law Enforcement Manual, 18-15

Standard Navy Distribution List (SNDL), 18-15

Standard Organization and Regulations of the U.S. Navy (SORM), OPNAVINST 3120.32, 18-15

The Department of the Navy Correspondence Manual, SECNAVINST 5216.5, 18-15

The United States Navy Uniform Regulations, 18-15

Official publications, and directives-Continued

United States Navy Physical Security and Loss Prevention Instruction, OPNAVINST 5530.14, 18-15

United States Navy Regulations, 1990, 18-14, 18-15

Operational tasks and techniques, 9-10

isolate the area, 9-11

operational task evaluation, 9-10

options when using force, 9-11

secure likely targets, 9-11

Organization and processing of evacuees, 14-11

berthing, 14-11

general quarters and emergency stations, 14-12

messing, 14-11

Organizational charts, 18-2

combination chart, 18-2

functional chart, 18-2

position chart, 18-2

structural chart, 18-2

Organizational structure, 18-1

determining factors, 18-1

Other body fluids, 16-33

identification, 16-33

other stains, 16-33

Other types of prints, 16-3

major case prints, 16-3

palm prints, 16-3

photographic print impressions, 16-3

P

Panic, 9-4

causes of panic, 9-5

prevention of panic, 9-5

Patrol activities, 12-1

Patrol organization, 12-1

dispatcher, 12-3

Patrol organization—Continued

- operations division officer, 12-2
- patrol supervisor, 12-2
- patrol watch commander, 12-2
- patrolmen, 12-3
- security officer, 12-2
- watch section field training officer, 12-3

Penalties, 7-11 D

- federal trafficking, 7-11
- federal trafficking-Marijuana, 7-12
- maximum punishments for controlled substances, 7-2

Perimeter and area protection and control, 10-6

- area designations, 10-7
- enclaving (island) security concept, 10-7

Personal appearance (men), 1-29

- beards, and mustaches, 1-30
- earrings, 1-31
- fingernails, 1-31
- hair, 1-29
- hairpieces, 1-30
- jewelry, 1-31
- necklaces/chokers, 1-31
- rings, 1-31
- sideburns, 1-30
- wristwatches/bracelets, 1-31

Personal appearance (women), 1-31

- cosmetics, 1-33
- earrings, 1-33
- fingernails, 1-33
- hair, 1-31
- hair ornaments, 1-32
- hairpieces, 1-32
- jewelry, 1-33
- necklaces/chokers, 1-33
- rings, 1-33
- wristwatches/bracelets, 1-33

Personal effects, 14-8

- categories of personal effects, 14-9
- classification of personal effects, 14-8
- enlisted personnel, 14-8
- inventory, 14-9
- officer personnel, 14-8
- responsibility for personal effects, 14-9

Personal property, 13-12

- duty-free exemption authority, 13-13
- evidence of extended duty, 13-12
- household goods and unaccompanied baggage, 13-12
- locked containers, 13-13
- restricted/prohibited articles, 13-13
- shipments not entitled to duty-free entry, 13-13

Personnel identification systems, 10-15

- access list system, 10-15
- escort system, 10-16
- exchange pass system, 10-16
- military/dependent identification cards, 10-15
- pass and badge system, 10-16
- personal recognition, 10-15
- U.S. Government identification card, 10-15

Personnel security investigations, 15-3

Persons subject to NJP 6-2

- NJP of embarked personnel, 6-2
- NJP of Reservists, 6-2
- personnel of another armed force, 6-2
- right to trial by court-martial, 6-3

Petty officer authority, 1-18

- authority and responsibility, 1-19
- general authority, 1-19
- lawful orders, 1-19
- organizational authority, 1-19

Phencyclidine and related drugs, 7-32

Physical apprehension and restraint techniques, 12-26

- come-along holds, 12-26
- defense against choke and body holds, 12-27
- front body hold, 12-28
- front choke hold, 12-27
- pressure point bar, 12-27
- rear arm bar, 12-27
- rear body hold, 12-28
- rear choke hold, 12-27

Physical evidence, 17-1

- definitions, 17-1
- evaluation, 17-1
- identification, 17-1

Physical security definitions, 10-1

- activity, 10-1
- auxiliary security force (ASF), 10-1
- counterterroism, 10-1
- exception, 10-1
- facility, 10-1
- installation, 10-1
- pilferage, 10-1
- plan of action and milestones (POA&M), 10-1
- property, 10-1
- security manager, 10-1
- security officer, 10-1
- waiver, 10-1

Physical security surveys, 10-14

- purpose of physical security surveys, 10-15
- types of physical security surveys, 10-15

Plain view searches, 3-11

Planning and programming, 18-2

- equipment, 18-3
- facilities, 18-3
- planning, 18-3
- requirements, 18-3
- units and personnel, 18-3

Pleas, 5-8, 5-12

- conditional pleas, 5-13
- guilty pleas, 5-12
- not-guilty pleas, 5-12

Points of interest, 4-2

Police baton, 12-23

- assumed (ready) position, 12-24
- chest or overhand attack, 12-25
- defensive movements, 12-25
- normal usage of the baton, 12-24
- slash attack, 12-26
- striking areas, 12-24
- underhand thrust attack, 12-25

Policy on releasing MWDS, 11-7

Polygraph examination, 16-40, 16-42

- definitions, 16-40
- investigator responsibility, 16-41
- legal status, 16-40
- polygraph examiner responsibility, 16-42
- polygraph examiners, 16-40
- pretest interview, 16-43
- prohibited practices, 16-42
- testing, 16-43
- theory, 16-42

Poor impressions, 16-4

Posse Comitatus Act, 2-4

Possible actions by the CO at mast, 6-23

Post-test interview, 16-43

- deception indicated, 16-43
- inconclusive, 16-43
- no deception, 16-43
- no opinion, 16-44
- supervision and review, 16-44

Postmast activity, 6-34

- Confinement Order (NAVPERS 1640/4), 6-34, 6-36
- enlisted service record entries, 6-37
- execution of NJP for enlisted personnel, 6-34
- letter of censure, 6-37

Pre-mast screening, 6-9
 NJP forms, 6-12
 preheating advice, 6-9
 preliminary inquiry, 6-9
 Preferral and referral of charges, 5-3
 informing the accused, 5-3
 preferral of charges, 5-3
 preliminary inquiry, 5-3
 referral of charges, 5-4
 Premises search, 12-44
 complete search, 12-44
 general inspection, 12-44
 Preparation for pretrial hearing, 5-17
 hearing date, 5-17
 post-hearing procedures, 5-17
 pretrial advice, 5-17
 rules of evidence, 5-17
 statements, 5-17
 testimony, 5-17
 witnesses, 5-17
 Prescribing uniform wear, 1-22
 Pretrial preparation, 5-4
 final pretrial preparation, 5-6
 preliminary preparation, 5-4
 pretrial conference with the accused, 5-4
 Prima facie evidence, 4-7
 Principles of civil disturbance control, 9-7
 coordinated preparation, 9-7
 minimum force, 9-8
 neutrality, 9-8
 operational unity, 9-8
 professional imagery, 9-7
 public acceptance, 9-8
 threat awareness, 9-7
 Prisoners of war, 14-12
 responsibilities, 14-12
 procedures, 14-13
 Probable-cause searches based upon prior authorization, 3-3
 delegation of the power to authorize searches, 3-5
 execution of the search authorization, 3-6
 jurisdiction over the person, 3-4
 jurisdiction over the property, 3-4
 jurisdiction to authorize searches, 3-4
 record of search authorization, 3-7
 the requirement for probable cause, 3-5
 the requirement of neutrality and detachment, 3-5
 Probable-cause searches without prior authorization, 3-8
 exigency search, 3-8
 insufficient time, 3-8
 lack of communication, 3-8
 search of operable vehicle, 3-8
 Probable cause to apprehend, 3-3
 Probable cause to search, 3-3
 Problem prints, 16-4
 Procedures for administering a warning, 2-13
 acts as statements, 2-14
 cleansing warning, 2-13
 right to counsel, 2-14
 when must the warnings be given, 2-13
 who must be warned, 2-13
 who must give the warning, 2-13
 Processing drug evidence, 7-44
 disposition of drugs, 7-46
 field tests, 7-45
 laboratory processing, 7-45
 Prohibited punishments, 5-23
 Protective lighting, 10-12
 continuous lighting, 10-13
 controlled lighting, 10-13
 emergency lighting, 10-13
 general principles and guidelines, 10-12

Protective lighting—Continued

- glare projection lighting, 10-13
- movable lighting, 10-13
- standby lighting, 10-13
- types of protective lighting systems, 10-12

Protective-lighting emergency power, 10-14

- switch and control protection, 10-14
- technical aspects, 10-14

Protective lighting parameters, 10-13

- minimum standards, 10-13

Psychological influences on collective behavior, 9-2

- anonymity, 9-2
- emotional contagion, 9-3
- impersonality, 9-3
- release from repressed emotions, 9-3
- suggestion and imitation, 9-3

Punitive articles of *UCMJ*, 2-16

- Articles 77 through 134 of *UCMJ*, Appendix III

R

Reasonable doubt, 4-7

Recommendations for successful DDD searches, 11-5

- data sheets and search results, 11-6
- duties and responsibilities of the recorder, 11-6
- duties and responsibilities of chief Master-at-Arms or command representative, 11-5
- field test information, 11-7

Recording impressions, 16-12

- casting, 16-12
- other casting materials and possible uses, 16-14
- photographing, 16-12
- plaster of Paris, 16-13
- sketching, 16-12
- special techniques, 16-15

Records and forms, 18-11

- Abandoned Vehicle Notice, 18-13
- Abandoned Vehicle Removal Authorization, 18-13

Records and forms—Continued

- Alcoholic Influence Report, 18-13
- Authority to Release Medical Information and Records, 18-13
- Civilian Suspects Acknowledgment of Rights Form, 18-12
- Complaint of Stolen Vehicle, 18-13
- Consent Search, 18-13
- Customer Consent and Authorization for Access to Financial Information, 18-13
- Desk Journal, 18-13
- Evidence/Property Custody Document, 18-13
- Evidence Tag, 18-13
- Field interview card, 18-14
- Field Test Results, 18-13
- Forensic Examination Report, 18-13
- Incident/Complaint Report, 18-12
- Interview/Interrogation Log, 18-13
- Law Enforcement Communications Log, 18-14
- Lineup, 18-13
- Military Suspects Acknowledgment of Rights Form, 18-12
- Notice of Vehicle Impoundment, 18-14
- Operator's Report of a Motor Vehicle Accident Report, 18-13
- Record of Authorization for Search, 18-13
- Telephonic Threat Complaint, 18-13
- Traffic Accident Report, 18-13
- Vehicle Impoundment Report, 18-13
- Vehicle Report, 18-13
- Voluntary Statement Form, 18-12

Referral of charges, 5-10

- referral to trial, 5-10
- withdrawal of charges, 5-11

Regulations, 7-8

- distribution, 7-10
- recordkeeping, 7-8
- registration, 7-8
- regulatory requirements, 7-9

Remington M870 shotgun, 8-15

- functioning of the Remington M870, 8-16
- maintenance, 8-8
- Remington M870 operating cycle, 8-17
- technical description, 8-16

Report and Disposition of Offenses(s), NAVPERS, 1626/7, 6-5

Reports, 14-4

Requests from civilian law enforcement agencies for MWD support, 11-8

Requests from civilian law enforcement agencies for MWD support outside the continental United States, 11-8

Res geste, 4-8

Responsibilities of the military customs inspector, 13-2

- customs declaration procedures, 13-3
- duty-free entry limitations, 13-5
- passengers and accompanied baggage, 13-2
- predeparture inspection/examination procedures, 13-3

Restricted and nonrestricted areas, 10-7

- level one (formerly controlled area), 10-8
- level three (formerly exclusion area), 10-7
- level two (formerly limited area), 10-8
- nonrestricted areas, 10-8

Right to counsel, 2-14

- Article 3 lb, 2-15
- custodial interrogation, 2-14
- how to give the warnings, 2-15
- scope of the right to counsel, 2-14

Rights and responsibilities, 1-1

- accusations, replies, and countercharges, 1-2
- conduct, 1-1
- sexual harassment and fraternization, 1-2

S

Safety, 14-5

Searches incident to lawful apprehension, 3-10

Searches not requiring probable cause, 3-8

- searches upon entry to or exit from U.S. installations, aircraft, and vessels abroad, 3-8

Security and counterintelligence matters, 15-3

Security committees, 10-3

- loss prevention subcommittee, 10-4
- physical security review board, 10-4
- physical security review committee, 10-4

Security inspections, 10-5

- administrative inspection of vehicles, 10-6
- exemption for naval criminal investigative service, 10-6
- quarterdeck inspections, 10-6

Security responsibilities, 10-1

- commanding officer, 10-1
- organizational relationships, 10-3
- security department, 10-2
- security manager, 10-2
- security officer, 10-2

Semisynthetic Narcotics, 7-16

- black tar heroin, 7-17
- heroine, 7-16
- hydromorphone, 7-17
- oxycodone, 7-18
- paregoric, 7-18

Serial numbers, 16-28

- investigative leads, 16-28
- jewelers' marks, 16-28
- restoration, 16-28

Services not provided by MWD teams, 11-8

7.62-MM M60 machine gun, 8-19

- operation, 8-20

Ship's brig responsibilities, 14-5

Shore patrol, 1-8
 shore patrol uniforms, 1-28

Shore patrol and beach guard, 14-1
 beachguard, 14-2
 shore patrol, 14-2

Shotguns, 8-15
 Mossberg M500 shotgun, 8-19
 Remington M870 shotgun, 8-15

Shoulder weapons, 8-9
 M14 rifle, 8-10
 M16A1 rifle, 8-13

Signs and posting of boundaries, 10-10

Similar facts, 4-7
 hearsay evidence, 4-8
 other offenses, 4-7
 similar facts, 4-7

Sketches and investigative notes, 16-49
 finished sketch, 16-50
 indoor areas, 16-52
 investigative notes, 16-52
 outdoor areas, 16-52
 rough sketch, 16-49
 sketches, 16-49

Slang terms for drugs, 7-39
 amphetamines, 7-39
 barbiturates, 7-39
 cocaine, 7-39
 hashish, 7-39
 heroin, 7-39
 LSD, 7-39
 marijuana, 7-39
 methaqualone, 7-40
 morphine, 7-40
 peyote, 7-40
 phencyclidine, 7-40

Small arms maintenance, 8-27

Smartness, 1-33

Soils, rocks, and minerals, 16-36
 collecting comparison samples, 16-38
 collection of evidence 16-37
 difference in soils, and rocks, 16-36
 laboratory examination, 16-38
 other mineral evidence, 16-37
 packaging and handling evidence, 16-38
 soils and rocks as evidence, 16-36

Sources of jurisdiction, 2-1
 federal statutes, 2-2
 the constitution, 2-1

Sources of the law of evidence, 4-1
 other sources, 4-2
 the Constitution, 4-1
 the Manual for Courts Martial, 4-1
 the Uniform Code of Military Justice, 4-1

Sources of the law of search and seizure, 3-1
 United States Constitution, 3-1
 probable cause, 3-1
 particularly described, 3-2
 exclusionary rule, 3-2
 Manual for Courts-martial (MCM), 3-2

Special court-martial, 5-8

Special court-martial: trial proceedings, 5-11
 adjournment, 5-14
 arguments on findings, 5-13
 arguments on sentence, 5-14
 assembly of the court, 5-13
 case on the merits, 5-13
 challenge procedure, 5-13
 clemency, 5-14
 extenuation and mitigation, 5-14
 motions, 5-12
 pleas, 5-8, 5-12

Special court-martial: trial proceedings-Continued

pre-sentencing procedure, 5-14

preliminary matters, 5-12

pretrial hearings, 5-12

service of charges, 5-12

the arraignment, 5-12

Special precautions for small arms, 8-26

Special uniform situations, 1-24

Standard Organization and Regulations of the U.S.

Navy, 1-8

customs, 1-12

duties of watches, 1-9

general regulations, 1-10

performance of duty of watch, 1-9

watchstanding principles, 1-9

Statistical reports, 18-7

calculating percentages and determining rates,
18-9

compilation, collection, and presentation of
statistical data 18-9

use of recorded data, 18-8

use of statistics, 18-8

Status of forces agreements, 2-5

application of status of forces agreements, 2-5

fairness of jurisdiction, 2-5

importance of status of forces agreements, 2-5

jurisdictional arrangements, 2-5

Stimulants, 7-21

cocaine, 7-22

cocaine free base and crack, 7-24

ecstasy, 7-25

methcathinone, 7-25

Stop and Frisk, 3-10

Stowage and issue of small arms, 8-27

storage facilities, 8-27

Summary court-martial punishments, 5-5

E-4 and below, 5-5

E-5 and above, 5-5

Summary court-martial: trial proceedings, 5-8

arraignment, 5-8

findings and sentence, 5-8

motions, 5-8

pleas, 5-8,5-12

presentation of evidence, 5-8

Surveillance operations, 15-23

“made”, “burned,” or “blown”, 15-23

contact 15-23

decoy, 15-23

planning factors, preparation, and personal
qualifications, 15-23

subject, 15-23

surveillant, 15-23

Surveillant precautions, 15-24

Suspect interrogation techniques, 15-36

confessions, 15-37

logic and reasoning, 15-36

number of investigators, 15-37

other techniques, 15-36

playing one suspect against another, 15-37

psychological approach 15-36

recording and evaluating interrogations, 15-37

the “cold shoulder”, 15-37

the hypothetical story, 15-37

Synthetic narcotics, 7-18

fentanyl analogues, 7-18

meperidine (pethidine), 7-18

methadone and related drugs, 7-18

T

Taking fingerprints, 16-2

final step, 16-3

initial steps, 16-2

inking, 16-2

plain impressions, 16-2

rolled impressions, 16-2

steps in taking fingerprints, 16-2

- Techniques of searching, 12-28
 - complete search of a person, 12-43
 - kneeling handcuff and search position, 12-32
 - prone handcuffing and search position, 12-37
 - standing rear cuff and search position, 12-28
- Territorial jurisdiction, 2-4
 - concurrent federal jurisdiction, 2-4
 - exclusive federal jurisdiction, 2-4
 - proprietary jurisdiction, 2-4
- The .38-caliber revolver, 8-8
 - disassembly and assembly, 8-8
 - operation, 8-8
- The ceremony for burial at sea, 14-7
 - cremation, 14-7
- The general court-martial, 5-14
- The interrogation, 15-35
 - direct approach, 15-36
 - indirect approach, 15-35
- The language of the law of search and seizure, 3-2
 - search, 3-2
 - seizure, 3-2
- The lineup, 15-22
 - preparing and directing the lineup, 15-22
- The NJP hearing procedure, 6-20
 - burden of proof, 6-23
 - hearing officer, 6-23
 - hearing requirements, 6-20
 - personal appearance waived, 6-20
 - personal representative, 6-23
 - public hearing, 6-23
 - publication of NJP results, 6-23
 - witnesses, 6-23
- The NJP package, 6-4
 - preparation of NAVPERS 1626/7, 6-5
 - Report and Disposition of Offenses(s), NAVPERS 1626/7, 6-5
- The pretrial investigation, 5-15
 - appointing order, 5-16
 - authority to direct, 5-15
 - counsel for the government, 5-15
 - defense counsel, 5-15
 - investigating officer, 5-15
 - mechanics of convening, 5-15
 - reporter, 5-16
- The summary court-martial, 5-1
- The urinalysis program, 3-14
 - fitness-for-duty testing, 3-16
 - search and seizure, 3-15
 - service-directed testing, 3-16
 - the collection process, 3-17
 - types of test, 3-15
 - urinalysis inspections under MRE 313, 3-16
 - uses of urinalysis results, 3-17
 - valid medical purposes, 3-16
- Tool marks, 16-24
 - basis of tool mark identification, 16-25
 - definitions, 16-25
 - examination techniques, 16-25
 - laboratory examination, findings, and value, 16-27
 - processing evidence, 16-26
 - transmittal to laboratory, 16-27
 - uses of tool mark evidence, 16-25
- Trace evidence, 16-24
- Traffic stops (high risk), 12-10
 - clearing the vehicle, 12-19
 - removal of other individuals (passenger(s)), 12-15
 - removal of the suspects (driver), 12-11
- Traffic stops (unknown risks), 12-7
- Training and appointment, 13-17
 - appointment, 13-18
 - training assistance, 13-18
 - training guidance, 13-18

- Traveling in uniform, 1-23
 - commuting, 1-24
- Types of evidence, 4-5
 - circumstantial evidence, 4-5
 - direct evidence, 4-5
- Types of intrusion detection systems, 10-19
 - central station, 10-19
 - local alarm, 10-19
 - police connection, 10-19
 - proprietary, 10-19
- Types of jurisdiction, 2-2
 - civilian jurisdiction, 2-2
 - jurisdiction over federal offenses, 2-3
 - military jurisdiction, 2-2
 - service-connection issue, 2-3
- Types of MWD teams, 11-1
 - dual qualificational/dual employment, 11-2
 - patrol/drug and drug-detector dog teams, 11-2
 - patrol/explosive and explosive-detector dog teams, 11-2
 - patrol MWD teams, 11-2
 - single-purpose MWDS, 11-2
- Types of persons interviewed and interrogated, 15-29
 - complainants and accusers, 15-30
 - distracting persons, 15-30
 - false accusers, 15-31
 - grudge-bearing and lying witnesses, 15-31
 - informers, 15-30
 - others, 15-30
 - sensation or publicity seekers, 15-30
 - victims, 15-30
 - witnesses, 15-30
- Types of physical security surveys, 10-15
 - follow-up survey, 10-15
 - initial survey, 10-15
 - supplemental survey, 10-15
- Types of surveillance, 15-25
- U**
- U.S. Customs, 1-7
 - customs, 1-12
 - customs and immigration inspections, 1-7
- U.S. Navy Regulations, 1-1
 - process, 1-6
 - abuse of authority, 1-7
 - accusations, replies, and countercharges, 1-2
 - alcohol and drugs, 1-3
 - authority of officers embarked as passengers, 1-8
 - authority over subordinates, 1-7
 - conduct, 1-1
 - contradictory and conflicting orders, 1-8
 - control of passengers, 1-4
 - customs and immigration inspections, 1-7
 - dealers, tradesmen, and agents, 1-5
 - delegation of authority, 1-7
 - delivery of personnel to civil authorities and service of subpoena or other exercise of authority, 1-7
 - inspection, muster, and sighting of personnel, 1-3
 - lending money and engaging in a trade or business, 1-3
 - making of gifts of presents, 1-2
 - manner of addressing officers, 1-7
 - observance of Sunday, 1-5
 - personal, government, and public property, 1-3
 - persons found under incriminating circumstances, 1-5
 - possession of weapons, 1-3
 - prisoners of war, 1-6
 - proper use of labor and materials, 1-6
 - publishing and posting orders and regulations, 1-6
 - purpose, 1-1
 - relations with organizations and military personnel embarked for passage, 1-5

U.S. Navy Regulations—Continued

responsibility, 1-1
rights and responsibilities, 1-1
search by foreign authorities, 1-6
sexual harassment and fraternization, 1-2
shore patrol, 1-8
unauthorized persons on board, 1-4

UCMJ articles, 2-6

Article 7—apprehension, 2-6
Article 8—apprehension of deserters, 2-7
Article 9—imposition of restraint, 2-7
Article 10—restraint of persons charged with offenses, 2-8
Article 11—reports and receiving of prisoners, 2-8
Article 12—confinement with enemy prisoners prohibited, 2-8
Article 13—punishment prohibited before trial, 2-8
Article 14—delivery of offenders to civil authorities, 2-9
Articles 77 through 134—punitive articles, Appendix III

Uniform policy, 1-23

commercial transportation, 1-23
commuting, 1-24
government transportation, 1-23
traveling in uniform, 1-23

Uniform regulations, 1-21

care of the uniform, 1-24
categorization of Navy uniforms, 1-22
civilian clothes in foreign countries, 1-34
civilian clothing, 1-33
correct wear of the uniform, 1-24
drug avocation prohibited, 1-34
grooming standards, 1-29
history of U.S. Navy uniforms, 1-21
naval personnel on duty with other services, 1-25

Uniform regulations-Continued

outfits, uniforms, and clothing, 1-15
personal appearance (men), 1-29
personal appearance (women), 1-31
prescribing uniform wear, 1-22
reflectorized materials, 1-25
smartness, 1-33
special uniform situations, 1-24
traveling in uniform, 1-23
types of uniforms, 1-22
uniform laws, regulations, and directives, 1-24
uniform policy, 1-23
uniforms for security personnel, 1-25
wearing uniform articles with civilian clothes, 1-34

Uniforms for security personnel, 1-25

badges, 1-26
correct wear (men), 1-26
correct wear (women), 1-27
protective clothing, 1-18
shore patrol uniforms, 1-28

Unit moves, 13-5

preclearance, 13-5
predeparture inspection, 13-5

Unit Punishment Book, (UPB), 6-37

United States Constitution, 3-1

exclusionary rule, 3-2
particularly described, 3-2
probable cause, 3-1
United States Constitution, 3-1

Utilization of personnel, 15-47

case load, 15-47
pairing investigators, 15-48
qualifications, 15-47
supervision, 15-48
time, 15-48

V

Vehicle search, 12-43

complete search, 12-43

exemption for naval criminal investigative
service, 10-6

simple search, 12-43

Vehicle surveillance, 15-26

other techniques, 15-26

preparation of surveillant vehicle, 15-26

Visiting, 14-3

damage control assistant, 14-3

deck department head, 14-3

department heads, 14-3

guides, 14-3

public affairs officer, 14-3

the CMAA, 14-4

the MIA force, 14-4

W

Who may testify, 4-9

accused and accomplice, 4-9

children, 4-10

counsel, 4-9

credibility of a witness, 4-10

disqualification of a witness, 4-10

husband and wife, 4-10

impeaching a witness, 4-10

Withholding of privileges, 1-20

Witness to interviews and interrogations, 15-29

Work programs, 18-3

Written statements, 15-38

statement and rights waiver forms, 15-38

Assignment Questions

Information: The text pages that you are to study are provided at the beginning of the assignment questions.

**COMMANDING OFFICER
NETPDTC
6490 SAUFLEY FIELD ROAD
PENSACOLA FL 32509-5237**

13 Mar 97

ERRATA #1

**Specific Instructions and Errata for
Nonresident Training Course**

Master-at-Arms

1. No attempt has been made to issue corrections for errors in typing, punctuation, and so forth, which do not affect your ability to answer the question or questions.
2. To receive credit for deleted questions, show this errata to your local course administrator (ESO/scorer) The local course administrator is directed to correct the course and answer key by indicating the questions deleted.
3. This errata superseded all previous errata
4. Assignment Booklet

Delete the following questions and leave the corresponding space blank on the answer sheet:

Questions

4-28 5-66 7-30
4-46

ASSIGNMENT 1

Textbook Assignment: "Rules and Regulations," chapter 1, pages 1-1 through 1-18.

- 1-1. What is the main task of the Master-at-Arms afloat and ashore?
1. To enforce the rules and regulations aboard ship only
 2. To enforce the rules and regulations ashore only
 3. To enforce the rules and regulations aboard ship and ashore

QUESTIONS 1-2 THROUGH 1-5 REFER TO HOW THE CONTINENTAL CONGRESS FORMED A LEGISLATIVE COMMITTEE TO OVERSEE AND SET UP RULES FOR GOVERNING THE NAVY.

- 1-2. On 13 October 1775 the Continental Congress voted to form a legislative committee to oversee naval matters. They decided to outfit a total of how many swift vessels?
1. Five
 2. Two
 3. Three
 4. Four
- 1-3. On the committee, there was an individual who believed in having a strong Navy. Who was he?
1. George Washington
 2. Benjamin Franklin
 3. Thomas Jefferson
 4. John Adams
- 1-4. Our rules and regulations were largely based on the Navy regulations of what country?
1. England
 2. France
 3. Germany
 4. Spain

- 1-5. How many articles pertaining to Rules and Regulations of the Navy were approved by Congress in November 1775?
1. 11
 2. 22
 3. 33
 4. 44

- 1-6. What is the principal regulatory document of the Department of the Navy?
1. Manual for Courts-Martial
 2. Standard Organization and Regulations
 3. United States Navy Regulations
 4. Manual of the Judge Advocate General

- 1-7. What authority is responsible for making sure that Navy Regulations conform to the current needs of the Navy?
1. The type commander
 2. The commanding officer
 3. The Chief of Naval Operations
 4. The Bureau of Naval Personnel

- 1-8. Conduct of naval personnel is explained in what-article of the United States Navy Regulations?

1. Article 1110
2. Article 1131
3. Article 1165
4. Article 1179

- 1-9. Sexual harassment of naval personnel is explained in what article of the United States Navy Regulations?

1. Article 1110
2. Article 1124
3. Article 1148
4. Article 1166

- 1-10. Which of the following statements is/are true regarding sexual harassment?
1. Reprisal action should not be taken against a person who provides information regarding sexual harassment
 2. An individual may not make a false accusation of sexual harassment
 3. Supervisors or commanders may not condone or ignore sexual harassment of which they have knowledge
 4. All of the above
- 1-11. What term identifies a personal relationship between an officer and an enlisted member that is unduly familiar and does not respect differences in grade or rank?
1. Ethics
 2. standards
 3. Harassment
 4. Fraternization
- 1-12. Fraternization is explained in what article of the United States Navy Regulations?
1. Article 1114
 2. Article 1133
 3. Article 1165
 4. Article 1175
- 1-13. A person who has been wronged by a superior may report the alleged offense. Which of the following aspects should NOT be included in such a report?
1. The name of the superior against whom the accusation is made
 2. The basis for the complaint
 3. The redress desired
 4. The possible motive for the alleged offense
- 1-14. An individual may provide a voluntary gift of nominal value to a superior under which of the following situations?
1. Illness
 2. Marriage
 3. Retirement
 4. All of the above
- 1-15. What article of the United States Navy Regulations pertains to engaging in a trade or business?
1. Article 1112
 2. Article 1124
 3. Article 1131
 4. Article 1165
- 1-16. Under what circumstances, if any, may an officer borrow money from an enlisted person?
1. When approved by the commanding officer
 2. When less than \$50.00
 3. When paid back within 3 months
 4. None
- 1-17. With reference to Article 1159 of Navy Regulations, which of the following publications specifically describes dangerous weapons?
1. MCM
 2. UCMJ
 3. JAGMAN
 4. Local directives
- 1-18. Article 1160 of Navy Regulations pertains to what type of property?
1. Public
 2. Personal
 3. Classified
 4. Government

- 1-19. Who has the authority to allow the use of alcoholic beverages on board any ship or aircraft, or in any Department of the Navy vehicle?
1. Commanding officer
 2. Secretary of Defense
 3. Secretary of the Navy
 4. Chief of Naval Operations
- 1-20. Government transportation of alcoholic liquors for personal use ashore is authorized under certain circumstances.
1. True
 2. False
- 1-21. Who prescribes the circumstances under which alcoholic liquors may be used onboard naval installations?
1. Executive officer
 2. Commanding officer
 3. Chief of Naval Operations
 4. Secretary of the Navy
- 1-22. What article of the UCMJ covers the illegal use of drugs in the Navy?
1. Article 86
 2. Article 92
 3. Article 112a
 4. Article 114b
- 1-23. Who is responsible for designating zones to be inspected by department heads?
1. Executive officer
 2. Commanding officer
 3. Senior watch officer
 4. Administrative officer
- 1-24. The commanding officer may hold personnel inspections on weekends or holidays in which of the following situations?
1. At sea only
 2. After a ceremony only
 3. Before liberty commences
 4. For the duty section only
- 1-23. Who is responsible for making sure no unauthorized people are on board before proceeding to sea?
1. Command duty officer
 2. Chief Master-at-Arms
 3. Executive officer
 4. Commanding officer
- 1-26. who exercises control of passage in and protracted visits to aircraft and ships of the Navy?
1. Commanding officer
 2. Secretary of the Navy
 3. Command Liaison Officer
 4. Chief of Naval Operations
- 1-27. Personnel of foreign Armed Forces are subject to the orders of the commanding officer of a ship when they are embarked for passage.
1. True
 2. False
- 1-28. Which of the following statements is/are true regarding the authority over an organized unit embarked for transportation only on a ship?
1. The unit commander retains authority before embarkation
 2. The CO of the ship retains authority over all embarked personnel
 3. Both 1 and 2 above
 4. The unit commander retains authority at all times

- 1-29. What should a commanding officer do with a person embarked for passage, but not in the armed services of the United States who is found under incriminating circumstances?
1. Keep the person under restraint or surveillance
 2. Release the person to immigration authorities if not a citizen of the United States
 3. If the person committed an offense under the authority of the CO, the CO should take such action as deemed necessary
 4. All of the above
- 1-30. Who must authorize the admittance of dealers or tradesmen within a command to conduct public business?
1. Supply officer
 2. Security officer
 3. Executive officer
 4. Commanding officer
- 1-31. Of the following statements regarding the observance of Sunday, which one is incorrect?
1. Work should not be required
 2. Ships should not be sailed
 3. Daily routines should not be modified
 4. Space should be designated for divine services
- 1-32. To comply with Article 137 of the Uniform Code of Military Justice, certain articles of the UCMJ should be explained to each enlisted person at which of the following times?
1. At each reenlistment
 2. After 10 months of service
 3. After 12 months of service
 4. After 18 months of service
- 1-33. The training and educational programs of a command should include which of the following manuals?
1. Navy Regulations
 2. Uniform Code of Military Justice
 3. Both 1 and 2 above
 4. Naval Military Personnel Manual
- 1-34. What publication contains the procedures for delivery of naval personnel to civil authorities?
1. Naval Military Personnel Manual
 2. Manual of the Judge Advocate General
 3. Navy Regulations
 4. Manual for Courts-Martial
- 1-35. The commanding officer should not allow any person representing a foreign state to search his or her ship.
1. True
 2. False
- 1-36. The commanding officer of a shore command should refuse permission to any person representing a foreign state to remove any of his or her personnel, except under which of the following circumstances?
1. When ordered by the Federal Bureau of Investigation
 2. When authorized by Federal law
 3. When provided for by international agreement
 4. When allowed by the Governor of the state
- 1-37. A shipboard commanding officer should take which of the following actions when receiving prisoners of war?
1. Treat them with humanity
 2. Preserve their personal property
 3. Supply them with proper rations
 4. All of the above

- 1-38. In a foreign port, when, if ever, should a commanding officer be subject to local customs regulations?
1. When carrying cargo for a private, commercial account
 2. When carrying government-owned cargo
 3. When required by foreign customs officials
 4. Never
- 1-39. Of the following officers, which ones do not necessarily have to be addressed by their grade?
1. Line officers
 2. Supply officers
 3. Dental officers
 4. Engineering officers
- 1-40. Which of the following personnel are NOT subject to naval authority?
1. Those retired from the Navy with pay
 2. Fleet Marine Corps reserves
 3. Fleet reserves
 4. Army reserves
- 1-41. In which of the following situations may a person exercise authority over his or her subordinates?
1. When on leave
 2. When on the sick list
 3. When taken into custody
 4. When suspended from duty
- 1-42. When authority is delegated, when, if ever, is the person delegating relieved of all responsibility?
1. When authority is properly exercised
 2. When orders and instructions are properly executed
 3. When the orders are given in writing
 4. Never
- 1-43. When embarked as a passenger, which of the following officers has authority over a commanding officer of a ship?
1. Captain senior to the commanding officer
 2. Flag officer eligible for command at sea
 3. Rear admiral
 4. Captain with title of commodore
- 1-44. The senior patrol officer in a foreign port may be assigned all but which of the following duties?
1. Assist military personnel in relations with civil courts and police
 2. Arrange for release of service personnel from civil authorities
 3. Provide services that favorably influence discipline and morale
 4. Establish a sufficient patrol of personnel to maintain order of persons on liberty
- 1-45. When, if ever, should officers and enlisted personnel assigned shore patrol duty be armed?
1. When on duty in a foreign country
 2. When on duty in the United states
 3. When prescribed by the senior officer present
 4. Never
- 1-46. Which of the following publications provides guidance in performing the duties of an MA?
1. SORM
 2. JAGMAN
 3. U.S. Navy Regulations
 4. Each of the above

- 1-47. Which of the following actions is NOT a watchstanding principle?
1. Receiving indoctrination and training
 2. Devoting full attention to duty
 3. Reviewing emergency procedures
 4. Failing to report violations
- 1-48. Of the following general regulations, which one is NOT considered as most pertinent to the Master-at-Arms?
1. UCMJ
 2. Security manual
 3. Command instructions
 4. U.S. Navy regulations
- 1-49. Except In emergencies, who must give permission to use the general announcing system (LMC)?
1. Officer of the deck
 2. Command duty officer
 3. Chief boatswain's mate of the watch
 4. Chief Master- at-Arms
- 1-50. Who should maintain custody of alcoholic beverages in transit on board ship?
1. Marine guard
 2. Supply officer
 3. Security officer
 4. Chief Master-at-Arms
- 1-51. Who is authorized to sign requests for the issue of alcohol on board ships?
1. Division chief
 2. Department head
 3. Division officer
 4. Executive officer
- 1-52. Of the following statements regarding a member's responsibility for the Armed Forces Identification Card, which one is false?
1. Only one card may be possessed
 2. An erased or altered card may not be possessed
 3. The card is not required when on leave; leave papers suffice
 4. The loss of a card should be reported immediately
- 1-53. The Armed Forces liberty pass, DD Form 345, should be used for which of the following personnel?
1. Officers only
 2. Enlisted members only
 3. Civilians only
 4. All personnel
- 1-54. While on liberty, a sailor is detained by civil authorities. With whom should this sailor quickly communicate?
1. Department head
 2. Division officer
 3. Officer of the deck
 4. Division leading chief
- 1-55. When you conduct reveille, all late sleepers should turn out at what time?
1. 0630
 2. 0700
 3. 0730
 4. 0800
- 1-56. At which of the following times are card games NOT authorized to be played?
1. During working hours
 2. During divine services
 3. Between taps and reveille
 4. All of the above

- 1-57. Who has the responsibility to check the medical quarantine list and deny liberty and leave to individuals on the list?
1. Department head
 2. Medical officer
 3. Division officer
 4. Chief Master-at-Arms
- 1-58. When a ship arrives in the United States after visiting a foreign port, who is responsible for accurately completing customs declarations prior to the ship's arrival?
1. Leading chief only
 2. Legal officer only
 3. Each individual
 4. Administrative officer only
- 1-59. When privately owned electrical equipment is brought aboard ship for use, who must inspect and approve it?
1. Safety officer
 2. Operations officer
 3. Engineering officer
 4. Executive officer
- 1-60. If a messcook contracts a venereal disease, the messcook must be treated and
1. placed on report
 2. placed on restriction
 3. removed from mess duty
 4. placed in quarantine
- 1-61. Hitchhiking is authorized for all naval personnel on or off base.
1. True
 2. False
- 1-62. Which of the following individuals is responsible for having a person who returns to the ship intoxicated examined by a medical officer?
1. Leading chief
 2. Division officer
 3. Command duty officer
 4. Chief Master-at-Arms
- 1-63. When an individual returns to the ship intoxicated and creates a disturbance or becomes dangerous, he should be placed
1. in the brig
 2. in the sick bay
 3. under protective restraint
 4. under guard
- 1-64. Who specifically designates authority to operate a government-owned motor vehicle?
1. Executive officer
 2. Commanding officer
 3. Transportation chief
 4. Transportation officer
- 1-65. Who should take custody of all narcotics and other controlled substances authorized for medical purposes?
1. Weapons officer
 2. Medical officer
 3. Supply officer
 4. Executive officer
- 1-66. At least how often should all narcotics and dangerous drugs be inventoried by a special inventory board?
1. Weekly
 2. Monthly
 3. Quarterly
 4. Semiannually

- 1-67. Who must approve issuing petitions or publications on board ship?
1. Chief of Naval Operations
 2. Secretary of the Navy
 3. Commanding officer
 4. Department head
- 1-68. When may a commander prohibit assemblies, congregations, or group discussions by off-duty personnel?
1. When they interfere with the safety of the ship
 2. When they present a clear danger to morale or discipline
 3. When classified information is at risk
 4. All of the above
- 1-69. Who must give permission prior to any person taking pictures of a naval unit or its equipment?
1. Division officer
 2. Executive officer
 3. Commanding officer
 4. Division leading chief
- 1-70. Who is responsible for publishing the plan of the day?
1. Executive officer
 2. Personnel officer
 3. Commanding officer
 4. Administrative officer
- 1-71. In accordance with OPNAVINST 6240.3, the prohibited zone for discharging trash extends seaward for a total of how many miles?
1. 25
 2. 50
 3. 75
 4. 100
- 1-72. Who must authorize the temporary removal of department publications from a naval unit?
1. Executive officer
 2. Supply officer
 3. Cognizant officer
 4. Department head
- 1-73. Personally owned small arms brought aboard a naval unit for transportation purposes will be turned in to which of the following persons for custody?
1. Division officer
 2. Supply officer
 3. First lieutenant
 4. Leading chief
- 1-74. Which of the following actions is/are prohibited?
1. Accepting money from a person in return for a service that is performed in the line of duty
 2. Giving money to a person for a service performed in the line of duty
 3. Making an alteration to equipment without explicit permission
 4. All of the above
- 1-75. No person may purchase a dangerous weapon prohibited by Navy Regulations in any port outside the United States unless authorized in writing by the commanding officer.
1. True
 2. False

ASSIGNMENT 2

Textbook Assignment: "Rules and Regulations (continued)," and "Legal Aspects of Military Law," chapters 1 and 2, pages 1-18 through 2-9.

- 2-1. Of the following leadership traits, which one(s) is/are characteristic of a successful leader?
1. Manipulate others to perform
 2. Demonstrate shortcuts
 3. Encourage, inspire, and motivate others
 4. Instill the attitude, "Do as I say, not as I do."
- 2-2. The desired qualities of officers and petty officers are described in what article of Navy Regulations?
1. Article 1020
 2. Article 1110
 3. Article 1132
 4. Article 1165
- 2-3. What article of Navy Regulations addresses the exercise of authority over subordinates?
1. Article 1020
 2. Article 1110
 3. Article 1132
 4. Article 1165
- 2-4. What is the purpose of Extra Military Instruction (EMI)?
1. Extra duty
 2. Arduous duty
 3. Light punishment
 4. Corrective instruction
- 2-5. Extra Military Instruction should not be assigned for more than a total of how many hours a day?
1. 6
 2. 2
 3. 3
 4. 8
- 2-6. As a leading petty officer, from whom do you receive authority to assign EMI?
1. Division officer
 2. Department head
 3. Executive officer
 4. Commanding officer
- 2-7. What manual authorizes temporarily withholding privileges from an individual?
1. JAGMAN
 2. U. S. Navy Regulations
 3. Manual for Courts-Martial
 4. UCMJ
- 2-8. Deprivation of normal liberty is legal under which of the following circumstances?
1. Punishment by Article 15
 2. Authorized pretrial restraint
 3. Protection of foreign relations
 4. All of the above
- 2-9. Which of the following uniforms is equivalent to civilian business attire?
1. Working
 2. Protocol
 3. Ceremonial
 4. Uniform of the day
- 2-10. Pride in appearance is the mark of a/an
1. good seaman only
 2. petty officer only
 3. officer only
 4. responsible military member

- 2-11. Who is assigned the responsibility for establishing and controlling uniform policies within the geographical limits of his or her area?
1. Commanding officer
 2. CNO area representative
 3. Type commander
 4. Secretary of the Navy
- 2-12. Who is responsible for Navy uniform policy afloat and for shore stations outside the jurisdiction of a naval area?
1. Senior officer present
 2. Chief of Naval Operations
 3. Secretary of the Navy
 4. Fleet commander
- 2-13. Who is responsible for ensuring that uniforms are properly worn and maintained?
1. Leading chief
 2. Executive officer
 3. Commanding officer
 4. Chief Master-at-Arms
- 2-14. Who should review uniform regulations to ensure enforceability?
1. Judge advocate
 2. Officer in charge
 3. Executive officer
 4. Chief Master-at-Arms
- 2-15. While traveling in uniform, which of the following uniforms may always be worn during any season of the year?
1. Working uniform
 2. Service dress blue
 3. Semite dress white
 4. Uniform of the day
- 2-16. May a prescribing authority authorize working uniforms for commuting to and from work? If so, what restrictions apply?
1. Yes; only when stationed overseas
 2. Yes; only when stationed in the United States
 3. Yes; but no stops should be made
 4. No
- 2-17. What size stencil should be used for uniform items?
1. 1 in.
 2. 1/3 in.
 3. 1 1/2 in.
 4. 1/2 in.
- 2-18. Which of the following statements regarding uniforms is NOT correct?
1. Government-owned clothing should be stenciled with the letters USN
 2. The exchange of clothing is authorized if both parties agree to the exchange
 3. Reflectorized materials may be applied to uniforms when authorized
 4. Organizational clothing should be issued on a loan basis
- 2-19. What authority determines the uniform worn by Masters-at-Arms afloat?
1. The department head
 2. The leading chief
 3. The local command
 4. The division officer

- 2-20. What is the proper location for the MAA/law enforcement badge for female personnel?
1. On the right side, centered on the pocket
 2. On the right side, centered 1/4 inch above the pocket
 3. On the left side, centered on the pocket
 4. On the left side, centered 1/4 inch above the pocket
- 2-21. Which of the following equipment should be worn by a person riding a two-wheeled vehicle?
1. Helmet
 2. Boots or heavy shoes
 3. Leather gloves
 4. All of the above
- 2-22. Grooming standards are based on several elements including neatness, cleanliness, safety, military image, and appearance.
1. True
 2. False
- 2-23. The bulk of a man's hair may not exceed a maximum of how many inches?
1. 6
 2. 2
 3. 3
 4. 4
- 2-24. Which of the following personnel are NOT allowed to have facial hair?
1. Messcooks
 2. Brig staff
 3. Brig prisoners
 4. Mess management personnel
- 2-25. When, if ever, are males authorized to wear an earring with the uniform?
1. While on liberty
 2. While on leave
 3. While attending social functions
 4. Never
- 2-26. When a female wears the jumper uniform, her hair may extend a maximum of how far below the top of the collar?
1. 1/2 in.
 2. 1 in.
 3. 1 1/2 in.
 4. 2 in.
- 2-27. Which of the following statements is correct regarding female cosmetics?
1. Faddish styles are inappropriate
 2. Lipstick colors should be conservative
 3. An artificial appearance should be avoided
 4. Each of the above
- 2-28. The military image reflected by attention to detail is a key element in the public image of the Navy.
1. True
 2. False
- 2-29. When are conservative sunglasses NOT authorized for wear?
1. While standing a quarterdeck watch in port
 2. While standing a lookout watch under way
 3. While standing a personnel inspection
 4. While on liberty in uniform

- 2-30. When, if ever, may enlisted personnel have civilian clothing in their possession aboard ship?
1. When sufficient space is available
 2. When authorized by the CO
 3. When authorized by the senior officer present
 4. Never
- 2-31. Which of the following uniform articles may be worn with civilian clothing?
1. Pea coat
 2. Working jacket
 3. Four-in-hand necktie
 4. Combination cap
- 2-32. Wearing or displaying clothing, jewelry, or tattoos depicting marijuana or other controlled substance is prohibited.
1. True
 2. False
- 2-33. What is one of the more important factors in the building of a well-disciplined organization?
1. Military law
 2. Direction
 3. Punishment
 4. Regulation
- 2-34. What military justice system did Congress establish for all members of the Armed Forces?
1. Manual for Courts-Martial
 2. Uniform Code of Military Justice
 3. Manual of the Judge Advocate General
 4. U.S. Navy Regulations
- 2-35. All personnel performing law enforcement work for the Navy should have a basic understanding of which of the following legal concepts?
1. Chain of command
 2. Patrol procedures
 3. Investigation
 4. Jurisdiction
- 2-36. The power of a court-martial to try a service member is contained in what article of the Constitution?
1. I
 2. VIII
 3. III
 4. IV
- 2-37. What article of the Constitution makes the President of the United States the Commander in Chief of the Armed Forces?
1. I
 2. II
 3. VI
 4. X
- 2-38. The president has exercised his Constitutional power by issuing which of the following manuals?
1. Manual for Courts-Martial
 2. Uniform Code of Military Justice
 3. Manual of the Judge Advocate General
 4. U.S. Navy Regulations
- 2-39. What authority established the magistrate and district courts?
1. Constitution
 2. Federal courts
 3. Federal statutes
 4. Bill of Rights

- 2-40. Of the following types of jurisdiction, which one(s) should a court-martial have in order to try a military member?
1. Over the person
 2. Over the offense
 3. Over the place
 4. All of the above
- 2-41. What article of the Uniform Code of Military Justice identifies certain active-duty personnel as subject to its jurisdiction?
1. Article 1
 2. Article 2
 3. Article 3
 4. Article 4
- 2-42. When, if ever, may civilians be tried under military jurisdiction?
1. During war declared by Congress
 2. When employed by the military
 3. When serving with special forces
 4. Never
- 2-43. MA3 Boate is accused of an offense that is not a pure military crime. What characteristic of the case determines military jurisdiction?
1. The type of offense
 2. The location of the offense
 3. A place-jurisdiction must be found
 4. A service connection must be found
- 2-44. Title 18 of the United States Code generally defines what types of crimes?
1. Minor misdemeanors
 2. Major misdemeanors
 3. Minor felonies
 4. Major felonies
- 2-45. Which of the following sources details investigative jurisdiction?
1. Manual for Courts-Martial
 2. Uniform Code of Military Justice
 3. Manual of the Judge Advocate General
 4. U.S. Navy Regulations
- 2-46. Incidents of actual, suspected, or alleged major criminal offenses should be referred to what authority?
1. FBI
 2. DEA
 3. ATF
 4. NCIS
- 2-47. Command investigators are usually limited to handling minor offenses.
1. True
 2. False
- 2-48. What act did Congress pass to avoid the task of maintaining a complete code of civilian criminal laws for military bases?
1. Posse comitatus
 2. Assimilative crimes
 3. Federal crimes
 4. Military code of crimes
- 2-49. Military reservations generally have what type of jurisdiction?
1. Exclusive only
 2. Concurrent only
 3. Exclusive or concurrent
 4. Separate
- 2-50. Generally, state laws have neither force nor effect in areas of federal jurisdiction. What type of jurisdiction is this?
1. Concurrent federal
 2. Exclusive federal
 3. Proprietary state
 4. Territorial state

- 2-51. Under concurrent jurisdiction both naval and state authorities could, in theory, prosecute a person. In what source can you find guidelines on how this should be done?
1. Manual for Courts-Martial
 2. Manual of the Judge Advocate General
 3. U.S. Navy Regulations
 4. Federal statutes
- 2-52. The federal government has acquired a degree of ownership of a piece of property but has not obtained legislative authority. What type of jurisdiction applies in this case?
1. Proprietary
 2. Concurrent
 3. Exclusive
 4. Territorial
- 2-53. Who has the ultimate responsibility for law enforcement jurisdiction in intercostal waterways?
1. The ship's commanding officer
 2. The base commanding officer
 3. The state police
 4. The U.S. Coast Guard
- 2-54. In which of the following sources can further guidance be found for maritime waterway and security zone jurisdiction?
1. Combined federal regulations 33
 2. Manual of the Judge Advocate General
 3. U.S. Navy Regulations
 4. Federal statutes
- 2-55. The intent of the Constitution to prevent the use of federal troops to enforce civilian laws is covered by what authority?
1. Assimilative crimes act
 2. Posse comitatus act
 3. Federal criminal statutes
 4. Federal exclusion rule
- 2-56. An MA on military duty is prevented by the posse comitatus act from stopping a fleeing felon.
1. True
 2. False
- 2-57. What is the purpose of the status of forces agreements?
1. To define the status of the forces of one country while stationed in the territory of another
 2. To define the jurisdiction of the forces of both countries
 3. To protect the rights of the forces of one country while stationed in the territory of another
 4. To protect the forces of one country from the host country's laws while stationed in the host nation
- 2-58. The status of forces agreements apply to which of the following forces?
1. Land only
 2. Land and sea only
 3. Sea and air only
 4. Land, sea, and air
- 2-59. The basic principle to be observed by any force in a country other than its own is found in what article of the NATO Status of Forces Agreement?
1. Article I
 2. Article II
 3. Article III
 4. Article IV
- 2-60. When the United States objects to the trial of U.S. personnel in foreign courts, what is the objection based upon?
1. Fairness of trial
 2. Principal
 3. Jurisdiction
 4. Difference in laws

- 2-61. In some cases, the status of forces agreements give the United States the primary right to exercise concurrent jurisdiction.
1. True
 2. False
- 2-62. Apprehension is defined as the act of
1. arresting a person
 2. taking a person into custody
 3. placing a person in a restriction-in-lieu-of-arrest status
 4. placing a person into confinement
- 2-63. What do you need to justify an apprehension?
1. Reasonable belief that the person committed the offense
 2. Legal proof
 3. Commission of an offense by a person
 4. Delegation of commanding officer's authority to you
- 2-64. Which of the following personnel may apprehend a military deserter?
1. A deputy sheriff
 2. An FBI agent
 3. A private citizen
 4. All of the above
- 2-65. Without delegation of authority, who may order an enlisted member into confinement?
1. Any commissioned officer
 2. A commanding officer only
 3. Any commissioned officer or warrant officer
 4. Any person assigned in law enforcement
- 2-66. Who may order a civilian into confinement?
1. The commanding officer of the civilian only
 2. Any commanding officer
 3. Any general officer
 4. Any officer
- 2-67. Once a person is apprehended, that person is subjected to how many forms of restraint?
1. One
 2. Two
 3. Three
 4. Four
- 2-68. The MCM provides for restriction as a measure in lieu of
1. apprehension
 2. custody
 3. confinement
 4. arrest
- 2-69. Arrest and restriction in lieu of arrest are alike in what way?
1. Any warrant officer or above may authorize these restraints
 2. The party is required to stay within specified limits
 3. The party has been proven guilty prior to these restraints
 4. Both restraints allow the party to perform all regular duties
- 2-70. Ordering a seaman into arrest necessitates telling him that he is
1. being taken into custody
 2. under arrest
 3. under arrest and directing him to remain within specified limits
 4. under arrest and confining him

IN ANSWERING QUESTIONS 2-71 THROUGH 2-75,
SELECT FROM COLUMN B THE ARTICLE OF UCMJ
IDENTIFIED BY ITS DESCRIPTION IN COLUMN A.
RESPONSES MAY BE USED MORE THAN ONCE.

<u>A. DESCRIPTIONS</u>	<u>B. ARTICLES</u>
2-71. Prohibits punishment before trial	1. 14
	2. 13
2-72. Prohibits confinement of Armed Forces members with enemy prisoners	3. 12
	4. 11
2-73. Concerns the delivery of offenders to civil authority	
2-74. Concerns the submission of reports on prisoners	
2-75. Prohibits refusal to accept prisoners when the committing officer furnishes a statement of the offense charged	

ASSIGNMENT 3

Textbook Assignment: "Legal Aspects of Military Law (continued)", and "Punitive Articles of the UCMJ," chapter 2, pages 2-9 through 2-16, and appendix III, pages AIII-1 through AIII-10.

- 3-1. When a person is apprehended, what is the meaning of the term "physical restraint"?
1. The loss of the person's free movement
 2. The physical force required to accomplish the apprehension
 3. The person is placed in confinement
 4. The person resists apprehension
- 3-2. In which of the following circumstances may it be necessary to use force to apprehend an offender?
1. When the offender has committed a serious crime
 2. When the offender resists apprehension
 3. When the offender uses abusive language
 4. When the offender threatens to run away
- 3-3. Apprehensions should be made only when based on which of the following reasons?
1. Known offenses
 2. Major offenses
 3. Positive knowledge
 4. Probable cause
- 3-4. When is an apprehension justified?
1. Anytime a crime has been committed
 2. Anytime for cause
 3. Anytime the facts and circumstances indicate a person committed an offense
 4. Under all of the above circumstances
- 3-5. Unless an offense is of a serious nature, you should NOT apprehend an officer unless it is under which of the following circumstances?
1. The officer is obviously drunk in public
 2. The officer is out of uniform
 3. You are ordered to do so by another officer
 4. You are ordered to do so by an officer superior to the offender only
- 3-6. You are the senior MA of a two-person patrol. As you approach an offender with the intent of apprehension, where should you place yourself in relation to the offender?
1. Right front
 2. Right rear
 3. Left front
 4. Left rear
- 3-7. In relation to the offender, where should the second MA take a position?
1. Right rear
 2. Left rear
 3. In the center, directly behind the offender
 4. Where directed by the senior MA
- 3-8. When it is necessary to effect an apprehension, bear in mind that courtesy and politeness on your part may elicit which of the following responses?
1. Better public relations
 2. Respect for law enforcement
 3. Smoother apprehensions
 4. All of the above

- 3-9. When evaluating a suspect prior to apprehension, which of the following information should you consider?
1. Any reasonable doubt that the suspect committed the offense
 2. If the charge is minor and whether the subject has been drinking
 3. That the suspect knows the charge and is aware of his rights
 4. The suspect's attitude, injuries, and probable cause
- 3-10. Once a decision to apprehend has been made, it should be effected quickly for which of the following reasons?
1. To prevent arguments
 2. To book and charge the suspect with minimum delay
 3. To remove the suspect from the scene with minimum delay
 4. To prevent discredit on the law enforcement organization
- 3-11. To properly effect an apprehension, which of the following statements to the suspect is sufficient?
1. COME WITH ME
 2. YOU'RE UNDER APPREHENSION
 3. GET IN MY VEHICLE
 4. A full reading of Article 31, UCMJ
- 3-12. On the scene, which of the following actions should you take immediately after effecting an apprehension?
1. Notify your headquarters of the apprehension and identify the suspect
 2. Notify the suspect's command
 3. Search the suspect for weapons
 4. Interrogate the suspect about the offense
- 3-13. The right of civilians to assist in maintaining peace applies to which of the following Navy personnel?
1. All members of the Navy
 2. Shore patrol only
 3. Officers only
 4. Petty officers and officers only
- 3-14. Under which of the following circumstances, if ever, may an MA ordinarily apprehend under the citizen's right to arrest?
1. When the MA has the commanding officer's permission
 2. When the offender is on a naval base
 3. At anytime the MA is on duty
 4. Never
- 3-15. An MA brought to trial for acts done while assisting civil authorities has what defense(s) available?
1. Superior orders only
 2. Military necessity only
 3. Superior orders and military necessity
 4. Title 16, U.S. Code
- 3-16. The Fifth Amendment contains which of the following provisions?
1. All persons are protected from illegal search
 2. All persons are protected from illegal seizure of their property
 3. No person shall be compelled in any criminal case to be a witness against himself
 4. Each of the above
- 3-17. Article 31 is a statutory enactment of judicial interpretations of what amendment of the Constitution?
1. Fifth
 2. Second
 3. Third
 4. Fourth

3-18. What is an explanation of a suspect's rights before questioning called?

1. Rights statement
2. Self-incrimination warning
3. Fifth Amendment warning
4. Pre-interrogation warning

3-19. The right of an accused in a criminal case to be informed of the nature of the accusation against him is covered under what amendment to the Constitution?

1. Fifth
2. sixth
3. Third
4. Fourth

3-20. The right to have the assistance of counsel for a person's defense is a right under what amendment to the Constitution?

1. Fifth
2. sixth
3. Third
4. Fourth

3-21. What two words are the keys to understanding UCMJ Article 31(a)?

1. Questioning and Interrogating
2. Compulsion and self-incrimination
3. Evidence and guilt
4. Self-incrimination and interrogation

IN ANSWERING QUESTIONS 3-22 THROUGH 3-27, SELECT THE SUBSECTION OF ARTICLE 31, UCMJ IN COLUMN B THAT MATCHES THE DESCRIPTION GIVEN IN COLUMN A. RESPONSES MAY BE USED MORE THAN ONCE.

	<u>A. DESCRIPTIONS</u>	<u>B. SUBSECTIONS OF ARTICLE 31</u>
3-22.	Protects suspects and witnesses from self-incrimination	1. 31a 2. 31b 3. 31C
3-23.	Prohibits you from interrogating a person prior to informing that person that he or she does not have to make a statement regarding the offense of which accused	4. 31d
3-24.	Requires you to inform a suspect that any statement given by him or her could be used in a court-martial	
3-25.	Protects persons against making statements before any military tribunal if the statement is not material to the issue	
3-26.	Precludes admission of immaterial or irrelevant evidence	
3-27.	Provides that evidence or statements obtained without affirmative compliance with Article 31 by the interrogator are inadmissible in a court-martial	

- 3-28. A failure to comply with Article 31 does not necessarily mean that a guilty person goes free.
1. True
 2. False
- 3-29. Of the following personnel, which one need NOT receive a rights warning during an investigation?
1. A suspect
 2. A witness
 3. The accused
- 3-30. Article 31 warnings may be given to suspects by which of the following persons?
1. NCIS agents
 2. Security personnel agents
 3. Persons acting on the request of the military in furtherance of a military investigation
 4. All of the above
- 3-31. A witness is being questioned and the interrogator suspects the witness has committed an offense. What, if anything, must the interrogator do?
1. Stop the questioning and inform NIS
 2. Warn the witness after the interrogation is over
 3. Warn the witness as soon as the interrogator suspects the witness
 4. Nothing
- 3-32. During an interrogation, an accused makes a confession without proper warnings being given. What type of a statement is this?
1. Voluntary
 2. Spontaneous
 3. Involuntary
 4. Compelled
- 3-33. What official body has sanctioned the cleansing warning procedure?
1. Supreme Court
 2. Judge Advocate General
 3. Court of Military Appeals
 4. Naval Criminal Investigative Service
- 3-34. An MA may ask a person questions to establish identity without giving an Article 31 warning at which, if any, of the following times?
1. When the person is a suspect
 2. When the person is a witness
 3. At any time
 4. None of the above
- 3-35. An MA must give an Article 31 warning to a person prior to making which of the following requests?
1. Having an individual identify property by pointing to it
 2. Requiring that an individual submit handwriting samples
 3. Requesting that an individual be fingerprinted
 4. Requesting physical examination by a licensed physician
- 3-36. Of the following acts, which one is NOT considered degrading?
1. Using a catheter
 2. Extracting blood
 3. Using a stomach pump
- 3-37. In a trial by court-martial, evidence obtained at an interrogation without the Tempia warning will be treated in what way?
1. As admissible
 2. As inadmissible
 3. As circumstantial
 4. As doubtful

- 3-38. With regard to custodial interrogation, a suspect is considered taken into custody under which of the following circumstances?
1. If the suspect is deprived of freedom of action in any significant way
 2. If the suspect could reasonably believe he or she is in custody
 3. Both 1 and 2 above
 4. When the suspect is placed under arrest only
- 3-39. Advice to the accused of the right to counsel is normally required at which of the following times?
1. When the accused is to be searched
 2. When the accused is to be fingerprinted
 3. When an Article 31 warning is not required
 4. When an Article 31 warning is required
- 3-40. An accused has no right to counsel at which of the following times?
1. At an Article 15 hearing
 2. At a summary court-martial
 3. Before making a decision concerning rejection of NJP
 4. Before making a decision concerning acceptance of NJP
- 3-41. In the military, "counsel" means a lawyer as defined in what source?
1. Article 1010, Navy Regulations
 2. Article 0901, Navy Regulations
 3. Article 27, UCMJ
 4. Article 37, UCMJ
- 3-42. An accused who is to be interrogated has the absolute right to have counsel present at which of the following times?
1. Before the interrogation
 2. During the interrogation
 3. Both 1 and 2 above
 4. After the interrogation is over
- 3-43. An accused may end an interrogation for which of the following reasons?
1. The accused is tired
 2. The accused has another appointment
 3. The accused is bored
 4. Each of the above
- 3-44. When an accused indicates a desire to terminate the interview after an Article 31 warning has been given, what action should be taken next?
1. The interview is continued and any statement made after the indication to terminate the interview is admissible in a trial
 2. The interview is continued and any statement made after the indication to terminate the interview is inadmissible in a trial
 3. The interview is terminated
 4. The accused is advised that failure to continue the interview would be in violation of Article 92, UCMJ
- 3-45. All suspects are entitled to warnings flowing from what amendments?
1. Fourth, fifth, and sixth
 2. Fourth and fifth only
 3. Fifth and sixth only
 4. Fourth and sixth only
- 3-46. Article 31b of the UCMJ imposes how many requirements?
1. One
 2. Two
 3. Three
 4. Four

- 3-47. After you have advised a suspect of the charges, the right to remain silent, and that anything he says may be used as evidence in a trial, what should you do next?
1. Ask him if he understands
 2. Begin your questioning
 3. Show him the evidence
 4. Read him Article 31
- 3-48. The warning requirement is met by simply reading Article 31 to the accused.
1. True
 2. False
- 3-49. If an accused orally waives his rights but refuses to sign a rights acknowledgement form, what should you do?
1. Call a lawyer
 2. Stop the interrogation
 3. Proceed with the questioning
 4. Compel the accused to sign the form
- 3-50. If a rights acknowledgement form is NOT available in a street interrogation, what should you do?
1. Secure a form before you interrogate
 2. Interrogate in the presence of two witnesses
 3. Obtain a lawyer for the suspect and interrogate
 4. Interrogate and keep notes on the circumstances
- 3-51. What are the punitive articles of the UCMJ?
1. 77 through 134
 2. 77 and 134 only
 3. 121 through 128 only
 4. 128 through 134 only
- 3-52. The offense of assault is covered in what article of the UCMJ?
1. 77
 2. 80
 3. 121
 4. 128
- 3-53. A person who commits a crime is called a/an
1. performer
 2. principal
 3. accomplice
 4. accessory
- 3-54. Of the articles defined as punitive, what article is NOT punitive in nature?
1. 77
 2. 78
 3. 80
 4. 81
- 3-55. A person who provides assistance to a known prisoner to enable the prisoner to escape is called a/an
1. principal
 2. accessory after the fact
 3. accessory during the fact
 4. accomplice
- 3-56. What article of the UCMJ covers an act done with specific intent to commit an offense, even though the attempt failed?
1. 78
 2. 80
 3. 121
 4. 129
- 3-57. What article of the UCMJ covers insubordinate conduct toward a warrant officer or petty officer?
1. 78
 2. 86
 3. 91
 4. 94

3-58. A person who quits his or her place of duty with intent to stay away permanently is guilty of what offense?

1. Desertion
2. Missing movement
3. Absence with leave
4. Failure to obey an order

3-59. Any member of the Armed Forces who without authority fails to go to his or her appointed place of duty at a prescribed time is in violation of what offense?

1. Desertion
2. Missing muster
3. Absence over leave
4. Absence without leave

3-60. A person who is derelict in the performance of his or her duty is in violation of what article of the UCMJ?

1. 92
2. 90
3. 86
4. 82

IN ANSWERING QUESTIONS 3-61 THROUGH 3-66, SELECT THE ARTICLE OF THE UCMJ IN COLUMN B THAT MATCHES THE DESCRIPTION IN COLUMN A. RESPONSES MAY BE USED MORE THAN ONCE.

	<u>A. DESCRIPTIONS</u>	<u>B. ARTICLES</u>
3-61.	Applies to a person who enables a prisoner committed to his or her charge to escape	1. 95 2. 96 3. 97
3-62.	Applies to the offense of a person who sells government property without proper authority	4. 108
3-63.	Describes a person who resists arrest or apprehension	
3-64.	Forbids the unlawful confinement of a person	
3-65.	Deals with a person who escapes from custody	
3-66.	Discusses an offense that includes wrongfully releasing a prisoner	

3-67. What article of the UCMJ covers drunken or reckless driving?

1. 100
2. 103
3. 108
4. 111

3-68. If found drunk on watch, which of the following persons should NOT be charged with the offense of drunk on duty?

1. An OOD
2. A quarterdeck messenger
3. A lookout
4. A duty storekeeper

- 3-69. An enlisted person of a ship's watch NOT performing the duties of a sentinel or lookout is found drunk on duty. What article of the UCMJ covers this violation?
1. 97
 2. 112
 3. 113
 4. 134
- 3-70. Under which of the following circumstances should a sentinel on post NOT be charged with Article 113 of the UCMJ?
1. When found drunk
 2. When found smoking
 3. When found sleeping
 4. When leaving his or her post before being regularly relieved
- 3-71. A service member who intentionally inflicts self-injury should be charged under what article of the UCMJ?
1. 114
 2. 115
 3. 116
 4. 117
- 3-72. A service member who gives false testimony under oath should be charged with what offense?
1. Perjury
 2. Extortion
 3. Breach of the peace
 4. False official statements
- 3-73. A service member who signs any false record with intent to deceive may be charged under what article of the UCMJ?
1. 81
 2. 88
 3. 107
 4. 109
- 3-74. A sailor, without intent, kills a shipmate through negligence. The sailor be charged under what article of the UCMJ?
1. 116
 2. 119
 3. 124
 4. 132
- 3-75. A member has been disrespectful toward his or her superior commissioned officer. What article of the UCMJ covers this offense?
1. 88
 2. 89
 3. 91
 4. 92

ASSIGNMENT 4

Textbook Assignment: "Search and Seizure," and "Military Law of Evidence," chapters 3 and 4, pages 3-1 through 4-8.

- 4-1. What Constitutional amendment protects an individual against unreasonable search and seizure?
1. First
 2. Fifth
 3. Sixth
 4. Fourth
- 4-2. It is strongly recommended that information given to establish probable cause for search should be given under oath.
1. True
 2. False
- 4-3. Where may guidance on the military law of search and seizure be found?
1. UCMJ
 2. MCM, Appendix 14
 3. U.S. Constitution
 4. Military Rules of Evidence
- 4-4. A probable cause to search is based on what factor?
1. A preponderance of the evidence
 2. Believable information
 3. Actual data
 4. Genuine basis
- 4-5. A senior noncommissioned officer who is an OIC may authorize a search.
1. True
 2. False
- 4-6. The jurisdiction to authorize a search includes what two elements?
1. Authority and neutrality
 2. Person and property
 3. Place and property
 4. Person and place
- 4-7. Which, if any, of the following jurisdictional considerations may be extended to a CO for an off-base search?
1. Place
 2. Person
 3. Property
 4. None of the above
- 4-8. Which, if any, of the following areas may be searched without probable cause?
1. A locker in a BEQ room
 2. A government-owned car assigned to an individual
 3. The desk of an individual
 4. None of the above
- 4-9. Under what specific circumstance may a foreign agent search an area considered an extension of the sovereignty of the United States?
1. When in pursuit of a known felon
 2. Only when assigned by a U.S. State Department representative
 3. When authorized by international agreement
 4. When probable cause is presented
- 4-10. To which of the following persons may a commanding officer-delegate the power to authorize a search?
1. Military judge
 2. Officer of the day
 3. Command duty officer
 4. Chief Master-at-Arms

- 4-11. A commanding officer taking action on a search authorization feels he cannot remain neutral and detached in his decision. Who may then authorize the search?
1. Legal officer
 2. Executive officer
 3. Command duty officer
 4. Next superior commander
- 4-12. The factual basis requirement for probable cause is met when an individual reaches which of the following conclusions?
1. The property in question is what it is alleged to be
 2. The property in question is located where it is alleged to be
 3. Both 1 and 2 above
 4. The property in question is in fact the means or fruit of a crime
- 4-13. With regard to probable cause determination, an informant's identity must be disclosed to the authorizing officer in order to establish reliability.
1. True
 2. False
- 4-14. Which of the following statements is/are true regarding the written record of search authorization?
1. It is not mandatory
 2. It helps prove the search was legal
 3. It helps the parties involved review the case
 4. All of the above
- 4-15. Of the following types of searches based on probable cause, which one should be conducted when immediate action is necessary to prevent loss of evidence of a crime?
1. Urgent
 2. Exigency
 3. Immediate
 4. Stop and frisk
- 4-16. For a consent search to be valid, in what specific manner must the consent be given?
1. Freely and voluntarily
 2. In the face of authority
 3. Intelligently and freely
 4. Informally and voluntarily
- 4-17. Of the following search situations, which one requires the Navy to inform the individual of his or her right to refuse?
1. Before a stop and frisk search
 2. When under the face of authority
 3. Before every consent search
 4. When a consent urinalysis is requested
- 4-18. A consent to search form executed by a suspected drug offender may be revoked at any time.
1. True
 2. False
- 4-19. The consent to search form must be signed by the person being searched and how many witnesses?
1. One
 2. Two
 3. Three
 4. Four

- 4-20. During a stop and frisk situation, to what extent may a person search another individual?
1. An internal search of all garment pockets
 2. A pat down or frisk of the outer garments
 3. The removal of clothing and shoes
 4. The emptying of pockets and a check under the beltline
- 4-21. A search incident to a lawful apprehension is limited to which of the following places?
1. The individual person
 2. The person's clothing
 3. The places that can be reached by the individual
 4. All of the above
- 4-22. Nonconsensual intrusions into body cavities may be performed by which of the following personnel?
1. Brig personnel only
 2. Police personnel only
 3. A person with appropriate medical qualifications only
 4. All personnel in an exigency basis
- 4-23. Evidence of contraband obtained through a normal physical evaluation may be seized.
1. True
 2. False
- 4-24. A military working dog's reliability may be determined by which of the following methods?
1. The accuracy of the dog's alert in a controlled situation
 2. The dog's record of training
 3. The amount of training conducted between the dog and handler
 4. The previous performance of the handler
- 4-25. What term identifies an examination conducted for the purpose of ensuring security, military fitness, and good order and discipline of an organization?
1. Inventory
 2. Inspection
 3. Gate search
 4. Shakedown search
- 4-26. What method is used to show that an inspection is not a subterfuge for a search?
1. Scheduling inspections in advance
 2. Scheduling inspections on weekends
 3. Conducting random inspections
 4. Conducting unannounced inspections
- 4-27. A military working dog is considered as what type of inspection aid?
1. Natural
 2. Biological
 3. Technological
 4. Human assisted
- 4-28. Which of the following sources provides detailed guidance for the collection, analysis, and use of urine samples?
1. OPNAVINST 5350.4
 2. MILPERSMAN
 3. JAGMAN
 4. SORM
- 4-29. Which of the following statements is true regarding persons suspected of drug abuse?
1. They may be asked to consent to urinalysis testing
 2. They may be asked to sign a urinalysis consent form
 3. An exigency search may be ordered
 4. Each of the above

- 4-30. Before urinalysis testing of an entire unit, approval should be granted by what authority?
1. Commanding officer
 2. Secretary of the Navy
 3. Second-echelon commander
 4. Chief of Naval Operations
- 4-31. Service-directed urinalysis testing falls under the authority of what official?
1. Chief of Naval Operations
 2. Chief of Naval Personnel
 3. Secretary of the Navy
 4. Commanding officer
- 4-32. Surveillance testing is periodic command-directed testing given to what personnel?
1. Those with suspicious behavior
 2. Those with discipline problems
 3. Those who do not participate in a drug rehabilitation program
 4. Those who have completed a drug rehabilitation program
- 4-33. What is the only constant with regard to service-directed urinalysis testing?
1. May refer members to a DOD treatment center
 2. May be used to vacate punishment under Article 15
 3. May be considered the basis for administrative separation
 4. May be used for disciplinary purposes
- 4-34. Some of the major sources for the military law of evidence are found in which of the following documents?
1. Statutes
 2. Constitution
 3. Scholarly writings
 4. All of the above
- 4-35. The military courts derive their existence from what article of the Constitution?
1. Article I
 2. Article II
 3. Article III
 4. Article IV
- 4-36. What article of the UCMJ is considered the key that opens the door to the military law of evidence?
1. 6
 2. 15
 3. 36
 4. 40
- 4-37. Who has prescribed the rules of evidence for military personnel?
1. President of the United States
 2. Chief of Naval Operations
 3. Judge Advocate General
 4. Secretary of the Navy
- 4-38. The military rules of evidence (MRE) are found in what source?
1. JAG Manual
 2. Navy Regulations
 3. U.S. Constitution
 4. Manual for Courts-Martial
- 4-39. Points of law on particular issues are interpreted by what judicial system(s)?
1. Court of Military Review
 2. Court of Military Appeal
 3. Both 1 and 2 above
 4. Federal District Courts
- 4-40. Of the following terms, which one is sometimes used to describe the rules of evidence?
1. Issues
 2. Elements
 3. Technicalities
 4. Interpretations

4-41. The MRE are NOT applied to what judicial proceeding?

1. General court-martial
2. Special court-martial
3. Summary court-martial
4. Captain's mast

4-42. The rules of evidence are made applicable to courts-martial by what MRE?

1. 15
2. 31
3. 101
4. 133

4-43. What is the ultimate issue at a trial by court-martial?

1. Guilt or innocence of the accused
2. Innocence of the accused only
3. Guilt of the accused only
4. Rights of the accused

4-44. What is the broader meaning of the term corpus delicti?

1. Murder victim
2. Element of an offense
3. Body or substance of crime
4. Fundamental facts connected with an illegal act

4-45. In which of the following offenses must intent be proven?

1. Rape
2. Burglary
3. Drunkenness
4. Neglect of duty

4-46. Evidence that the accused was drunk could constitute a defense for the commission of which of the following acts?

1. Rape
2. Arson
3. Murder
4. Larceny

4-47. An accused is required to assume the burden of proof to show innocence to which, if any, of the following offenses?

1. Rape
2. Arson
3. Neglect of duty
4. None of the above

4-48. Evidence is divided into a total of how many basic forms?

1. Five
2. Two
3. Three
4. Four

IN ANSWERING QUESTIONS 4-49 THROUGH 4-54, SELECT THE FORM OF EVIDENCE FROM COLUMN B THAT MATCHES THE DESCRIPTION GIVEN IN COLUMN A. RESPONSES MAY BE USED ONCE, MORE THAN ONCE, OR NOT ALL.

	<u>A. DESCRIPTIONS</u>	<u>B. FORMS OF EVIDENCE</u>
4-49.	Sworn testimony received at trial	1. Documentary
4-50.	A writing that is offered into evidence	2. Real
4-51.	Any physical object offered into evidence	3. Demonstrative
4-52.	Photographs and X-Rays	4. Oral
4-53.	The "personal view" principle	
4-54.	A witness makes a gesture to convey information	

- 4-55. The courts assume that Department of Defense documents are genuine.
1. True
 2. False
- 4-56. When a document is to be introduced as evidence and only part of it is to be read to the court, what portion of the document must be submitted?
1. The entire document
 2. The cover of the document and that portion to be read only
 3. The section or chapter of the document containing the portion to be read only
 4. The portion to be read only
- 4-57. A knife used to take the life of a victim is what form of evidence?
1. Real
 2. Indirect
 3. Documentary
 4. Demonstrative
- 4-58. Evidence that is partly documentary and partly real is what category of evidence?
1. Oral
 2. Partial
 3. Indirect
 4. Demonstrative
- 4-59. What are the two types of evidence?
1. Direct and indirect
 2. Admissible and indirect
 3. Direct and circumstantial
 4. Circumstantial and admissible
- 4-60. A confession from an accused is what type of evidence?
1. Real
 2. Direct
 3. Demonstrative
 4. Circumstantial
- 4-61. Evidence that tends to establish a fact from which a fact in issue may be inferred is what type of evidence?
1. Real
 2. Direct
 3. Demonstrative
 4. Circumstantial
- 4-62. Direct evidence is superior to circumstantial evidence.
1. True
 2. False
- 4-63. Admissibility of evidence depends on what factor(s)?
1. Relevancy
 2. Competency
 3. Authenticity
 4. All of the above
- 4-64. What is meant by the authenticity of evidence?
1. The identity of the evidence
 2. The admissibility of the evidence
 3. The genuine character of the evidence
 4. The relevancy of the evidence
- 4-65. A trial counsel and defense counsel agree that a certain item sought to be introduced into evidence is what it purports to be. What is this agreement called?
1. A stipulation
 2. An authentication
 3. A mutual gesture
 4. An attestation

- 4-66. What is a definition of relevancy as applied to evidence?
1. The evidence has been accepted by the court as admissible
 2. The information will reasonably tend to prove or disprove any matter in issue
 3. The evidence has been proven to be competent
 4. The identity of the evidence has been authenticated
- 4-67. Evidence that is relevant and not barred by any exclusionary rule is described by what term?
1. Relevant
 2. Competent
 3. Authentic
 4. Stipulation
- 4-68. Competency of evidence is a matter of whether or not the evidence can meet what test(s)?
1. Public policy, reliability, undue prejudice, and relevancy
 2. Public policy, reliability, and undue prejudice only
 3. Public policy and reliability only
 4. Public policy only
- 4-69. What is prima facie evidence?
1. Evidence that will prove or disprove any matter in issue
 2. Evidence that is admissible as fit and appropriate proof in a particular case
 3. Evidence that would be objectionable as irrelevant
 4. Evidence that is good and sufficient, on its face, to meet the issue if no other testimony is offered
- 4-70. How does the prosecution establish a prima facie case?
1. By introducing enough evidence to outweigh the general presumption that the accused is innocent
 2. By providing enough good evidence against the accused to ensure an airtight case
 3. By shifting the burden of proof to the accused
 4. By presenting evidence that is entirely circumstantial
- 4-71. When, if ever, may a prima facie case be overthrown?
1. Upon an appeal of the trial
 2. When the accused introduces sufficient evidence in rebuttal
 3. When the accused objects to the evidence that is presented
 4. Never
- 4-72. What is meant by reasonable doubt?
1. An honest and real doubt caused by insufficient proof
 2. Proof beyond the possibility of mistake
 3. Doubt caused by a fault-finding attitude
 4. Doubt caused by moral attitude
- 4-73. In a case involving drunkenness, which of the following statements would be admissible?
1. The accused was drunk the day before that specified
 2. The accused is known to be a heavy drinker
 3. The accused was in the company of others who were drunk
 4. The accused had been drinking a short time prior to that specified

4-74. Evidence of other offenses or acts of misconduct may be introduced when the evidence tends to accomplish which of the following actions?

1. Identifies a person as the Perpetrator of an offense
2. Proves a plan of the accused
3. Proves guilty knowledge or intent
4. All of the above

4-75. Hearsay testimony is best described as what kind of evidence?

1. Overruled
2. Secondhand
3. Presumptive
4. Prima facie

ASSIGNMENT 5

Textbook Assignment: "Military Law of Evidence (continued)," and "Courts-Martial Procedures," chapters 4 and 5, pages 4-8 through 5-15.

- 5-1. Hearsay is generally not admitted in evidence.
1. True
 2. False
- 5-2. Dying declarations of an alleged victim are excepted from what rule?
1. Documentary
 2. Res gestae
 3. Prima facie
 4. Hearsay
- 5-3. In most cases, if a dying declaration is to be introduced at a trial for criminal homicide, in what condition must the person be at the time of trial?
1. Dead
 2. Critical
 3. In extremity
 4. Impending death
- 5-4. Which of the following is an example of an exception to hearsay testimony?
1. Affidavit
 2. Res gestae
 3. Prima facie
 4. Documentary
- 5-5. Which of the following definitions best describes res gestae?
1. Any evidence that is admissible as hearsay
 2. A statement made under conditions where the victim was in extremity
 3. Voluntary exclamations or acts made at the time the offense was committed
 4. Involuntary exclamations or acts made at the time the offense was committed
- 5-6. During trial, evidence is first introduced by whom?
1. The prosecution
 2. The defense counsel
 3. The court bailiff
 4. The senior court member
- 5-7. When, if ever, may one witness be present in court while another witness testifies?
1. When the judge orders the witness to hear the testimony
 2. When the trial counsel and defense counsel agree to the presence of the witness
 3. When the second witness has finished his or her testimony
 4. Never
- 5-8. Objection to a witness on grounds of incompetence is made at what time?
1. Before the court convenes only
 2. Before the court reaches a verdict only
 3. Before the witness is sworn only
 4. At any time
- 5-9. A court-martial convened by the Navy can require the appearance of witnesses from which of the following services?
1. Navy only
 2. Navy and Marine Corps only
 3. Navy, Marine Corps, and Coast Guard only
 4. All Armed Forces

- 5-10. When a witness is stationed near the location where the court convenes, by whom is the witness notified?
1. CO of the witness
 2. Trial counsel
 3. Military judge
 4. Defense counsel
- 5-11. When practicable, a request for the attendance of a military witness is made to allow a minimum notice of how many hours before court convenes?
1. 12
 2. 24
 3. 48
 4. 72
- 5-12. A subpoena is normally issued for a civilian witness a minimum of how many hours before the time the witness must travel from home to comply with the subpoena?
1. 12
 2. 24
 3. 48
 4. 72
- 5-13. When, if ever, may an accused be forced to testify?
1. When ordered by his or her CO
 2. When compelled by a military judge
 3. When the defense counsel calls him or her to the witness stand
 4. Never
- 5-14. When is an accomplice competent to testify?
1. At all times
 2. In a capital offense only
 3. When asked by the judge only
 4. When a credible witness only
- 5-15. When, if ever, may a trial counsel be required to testify?
1. After the verdict
 2. Before the court proceedings
 3. When his or her testimony is desired
 4. Never
- 5-16. A child must be 16 years old in order for his or her testimony to be admissible.
1. True
 2. False
- 5-17. When, if ever, may a husband testify to confidential communications received from his wife?
1. When the wife has given consent
 2. When ordered by the judge
 3. Under any circumstances
 4. Never
- 5-18. In cross-examination, what type of evidence may NOT be introduced to attack the credibility of the witness?
1. Proving that the witness was convicted of a crime involving moral depravity
 2. Testimony as to the character of the witness
 3. Proving that the witness was previously convicted of perjury
 4. Testimony that the witness has a bad reputation for truthfulness
- 5-19. Who decides whether or not a witness is competent to testify?
1. The trial counsel only
 2. The defense counsel only
 3. The judge only
 4. The trial counsel, the defense counsel, or the judge

- 5-20. The testimony of a witness may be impeached if it is proved that the witness made contradictory statements during the present trial.
1. True
 2. False
- 5-21. Which of the following is a definition of a deposition?
1. A written declaration under oath or affirmation made by a witness in the presence of the adverse party
 2. An oral declaration under oath made by a witness in the presence of the adverse party
 3. A written declaration made by the accused and witnessed by two other persons
 4. An oral declaration made by an accused and witnessed by two other persons
- 5-22. A deposition may be taken by which of the following persons?
1. A legal officer
 2. A court officer
 3. A notary public
 4. Each of the above
- 5-23. Depositions are NOT in violation of the hearsay rule for what reason(s)?
1. Because the witness is placed under oath only
 2. Because there is an opportunity for cross-examination only
 3. Because the witness is under oath and there is an opportunity for cross-examination
 4. Because the accused is present while the deposition is taken
- 5-24. An affidavit differs from a deposition in what way?
1. An affidavit is made without giving the other side an opportunity to ask questions of the declarer
 2. An affidavit is unsworn
 3. An affidavit is hearsay
 4. An affidavit is always admissible
- 5-25. During the examination of a witness, the fourth examination of the witness is known by what term?
1. Redirect examination
 2. Re-cross-examination
 3. Cross-examination
 4. Cross-direct-examination
- 5-26. Leading questions are allowed in court proceedings at which of the following times?
1. When asked by the defense counsel
 2. When asked by the trial counsel
 3. When the witness appears hostile to the party who called him or her
 4. When a double question is asked
- 5-27. Are double questions allowed in court? If so, under what circumstances?
1. Yes; when asked by the trial counsel
 2. Yes; to shorten court proceedings
 3. Yes; when confronted by a hostile witness
 4. No
- 5-28. During a trial, which of the following types of questions is NOT forbidden?
1. Classified military question
 2. Incriminating question
 3. Degrading question dealing with a material issue of a trial
 4. Degrading question dealing with a minor issue of a trial

- 5-29. A witness may NOT give his or her opinion regarding which of the following characteristics of a person?
1. Sanity
 2. Sobriety
 3. Identity
 4. Guilt
- 5-30. Are witnesses allowed to discuss their testimony with any of the following persons? If so, with whom?
1. Yes; the accused
 2. Yes; other witnesses
 3. Yes; any court official
 4. No
- 5-31. Of the following types of offenses, which one should be tried at a summary court-martial?
1. Major
 2. Minor
 3. Capital
 4. Serious
- 5-32. A summary court-martial has no civilian equivalent.
1. True
 2. False
- 5-33. The power to convene a summary court-martial rests with what authority?
1. JAG office
 2. Executive officer
 3. Commanding officer
 4. Authorized command
- 5-34. An individual tried by a state court may only be retried by a summary court-martial with the permission of what authority?
1. Commanding officer
 2. Secretary of the Navy
 3. Chief of Naval Operations
 4. Officer exercising general court-martial jurisdiction
- 5-35. Before any case may be brought before a summary court-martial, the court must be properly
1. charged
 2. convened
 3. regulated
 4. documented
- 5-36. A summary court-martial is created in what manner?
1. By order of the convening authority detailing the summary court-martial officer
 2. By annotation on the report chit referring it to court-martial
 3. By order of the commanding officer
 4. By order of the executive officer
- 5-37. A summary court-martial requires how many officers?
1. One
 2. Two
 3. Three
 4. Four
- 5-38. The summary court-martial officer must be at least what grade?
1. 01
 2. 02
 3. 03
 4. 04
- 5-39. When the convening authority is the only commissioned officer in a unit and he wishes to convene a summary court-martial, which of the following actions is recommended?
1. Take the accused to mast
 2. Refer the case to the next higher authority
 3. Forward the case to another command
 4. Appoint an officer from another command

- 5-40. Which of the following personnel may be tried by a summary court-martial?
1. A commissioned officer
 2. A warrant officer
 3. A petty officer
 4. A midshipman
- 5-41. If the number of charges exceed the amount of room provided on a charge sheet, what action should be taken?
1. Continue the charges on a second charge sheet
 2. Place them on a separate sheet of paper as enclosure (1)
 3. Place them on a separate sheet of paper as attachment A
 4. Place them in part II of the charge sheet
- 5-42. The signature of the accuser should appear in what block of the charge sheet?
1. I
 2. II
 3. III
 4. IV
- 5-43. For what reason is an accused informed of the charges?
1. To provide a reasonable notice of impending prosecution
 2. To provide a forum notice of the charges
 3. To start the speedy trial requirement
 4. To start the statute of limitations
- 5-44. Once the referral of a summary court-martial case has been properly executed, what action should be taken next?
1. Prepare the convening order
 2. Inform the accused of the charges
 3. Conduct a preliminary inquiry
 4. Forward the case file to the summary court-martial officer
- 5-45. After referral, are changes allowed on the charge sheet to correct minor errors? If so, In what manner?
1. Yes; but the charges must be resworn
 2. Yes; but the changes must be initialed by the accused
 3. Yes; but the changes must be initialed by the summary court-martial officer
 4. No
- 5-46. Of the following documents, which one contains information on a pretrial conference for a summary court-martial?
1. JAGMAN
 2. Charge sheet
 3. MCM, Appendix VI
 4. MCM, Appendix IX
- 5-47. May reduction in rate be awarded at a summary court-martial for E-5 and above? If so, to what maximum number of inferior paygrades?
1. Yes; one
 2. Yes; two
 3. Yes; three
 4. No
- 5-48. At a summary court-martial, the accused has a statutory right to civilian counsel at military expense.
1. True
 2. False
- 5-49. In which, if any, of the following documents may the trial guide for a summary court-martial be found?
1. MCM Appendix IX
 2. JAG Manual, Chapter 5
 3. Navy Legal Manual, Chapter 2
 4. None of the above

- 5-50. Who is responsible for making sure only legal and competent evidence is presented at a summary court-martial?
1. The accused's defense counsel
 2. The court-martial officer
 3. The convening authority
 4. The accused
- 5-51. If a summary court-martial officer has a question regarding the admissibility of evidence, from what source should assistance be obtained?
1. Area coordinator
 2. Any judge advocate
 3. Convening authority
 4. Navy legal service office
- 5-52. What are the major steps of a summary court-martial?
1. Charges, pleas, presentation of the evidence, findings, and sentence
 2. Arraignment, motions, pleas, presentation of the evidence, findings, and sentence
 3. Motions, pleas, findings, and sentence
- 5-53. At a summary court-martial, an accused may change any plea at any time before which of the following events?
1. Sentencing
 2. Arraignment
 3. Findings are announced
 4. Presentation of evidence
- 5-54. When evidence is presented at a summary court-martial, the witnesses for the accused are called first.
1. True
 2. False
- 5-55. A special court-martial must have a minimum of how many members?
1. One
 2. Two
 3. Three
 4. Four
- 5-56. A special court-martial consisting of three members, counsel, but no military judge may NOT award which of the following punishments?
1. Bad conduct discharge
 2. Confinement for 6 months
 3. Reduction in rate to E-1
 4. Forfeiture of two-third's pay per month for 6 months
- 5-57. In a special court-martial with military judge and members, what person is responsible for presiding during deliberations?
1. Military judge
 2. Senior member
 3. Trial counsel
 4. Elected member
- 5-58. What are the elements needed for a court-martial to properly try a case?
1. Jurisdiction over the offense, defendant, and proper convening authority
 2. Jurisdiction over the offense and defendant only
 3. Defendant and proper convening authority only
- 5-59. Which of the following groups of members may properly sit on a special court-martial of an accused Navy Lieutenant?
1. CDR, LT, and ENS
 2. LT, LTJG and CW02
 3. LCDR, LTJG, and ENS
 4. CDR, MAJ (USMC), and LCDR

- 5-60. When an enlisted accused requests enlisted members sit on a special court-martial, what fraction of the court must consist of enlisted members?
1. One-fourth
 2. One-third
 3. One-half
 4. Two-thirds
- 5-61. When enlisted members are requested, but cannot be assigned due to extraordinary circumstances, what action must be taken?
1. The reasons must be annotated in the special instructions block of the charge sheet
 2. The reasons must be explained in the convening order
 3. The convening authority must forward a detailed explanation to the trial counsel
 4. An explanation must be prepared for inclusion in the issuing order
- 5-62. The military judge of a special court-martial should have which of the following qualifications?
1. Commissioned officer
 2. A member of the bar of a Federal court
 3. Certified by the Judge Advocate General
 4. All of the above
- 5-63. When charges are officially withdrawn on the charge sheet, who must initial and date the changes?
1. The defendant
 2. The trial counsel
 3. The convening authority
 4. The prosecuting attorney
- 5-64. In what way should a convening authority withdraw a case from one court and refer it to a new court?
1. By preparing a new page 1 to the charge sheet
 2. By preparing a new page 2 to the charge sheet
 3. By executing a new block 10 referral on the charge sheet
 4. By executing a new block 14 referral to the charge sheet
- 5-65. While awaiting trial, an accused commits new offenses. How should these additional charges be referred?
1. By making pen and ink changes to the original charge sheet
 2. By completing a new charge sheet
 3. By completing a new page 1 of the charge sheet
 4. By attaching a continuation page to the original charge sheet
- 5-66. At a special court-martial in times of peace, an accused be brought to trial a minimum of many days after formal charges have been served?
1. 1
 2. 2
 3. 3
 4. 4
- 5-67. What means of communication should the trial counsel use to notify the accused?
1. By letter
 2. In person
 3. The charge sheet
 4. By written orders
- 5-68. Of the following types of pleas, which one is the strongest form of proof known to the law?
1. Guilty
 2. Not guilty
 3. Conditional
 4. Nolo contendere

- 5-69. A special court-martial is composed of five members. How many members must agree on a finding of guilty?
1. Five
 2. Two
 3. Three
 4. Four
- 5-70. In a court-martial, for what reason are matters in mitigation of an offense introduced?
1. To lessen the punishment adjudged by the court
 2. To explain the circumstances surrounding the offense
 3. To aid the court in determining an appropriate sentence
 4. To form a legal justification for the offense
- 5-71. In a member's trial, who is responsible for announcing the sentence?
1. Bailiff
 2. Trial counsel
 3. Military judge
 4. President of the court
- 5-72. Which of the following types of courts-martial provides the greatest penalties provided by military law?
1. summary
 2. Special
 3. General
- 5-73. Of the following types of investigation, which one must be conducted before a general court-martial may lawfully occur?
1. Formal
 2. General
 3. Pretrial
 4. Preliminary
- 5-74. What is the purpose of an Article 32 pretrial investigation?
1. To formally inquire into the allegations contained in the charge sheet
 2. To prepare the government's case against the accused
 3. To ensure the allegations made in the charge sheet are factual
 4. To ensure the viability of the evidence presented in the case
- 5-75. What action initiates an Article 32 pretrial investigation?
1. Written request from the trial counsel
 2. Written orders of the convening authority
 3. Written request from the president of the court
 4. The completion of DD Form 457

ASSIGNMENT 6

Textbook Assignment: "Courts-Martial Procedures (continued)," and "Nonjudicial Punishment," chapters 5 and 6, pages 5-16 through 6-37.

- 6-1. A military counsel must be qualified under what article of the UCMJ?
1. 19
 2. 27
 3. 28
 4. 38
- 6-2. What official is responsible for making the initial determination on the availability of military witnesses?
1. Convening authority
 2. Counsel for the government
 3. Commanding officer of the witness
 4. Pretrial investigation officer
- 6-3. During an Article 32 investigation, a witness is not reasonably available. If the defense objects, what type of statement may the investigating officer consider?
1. Sworn
 2. Written
 3. Unsworn
 4. Prior testimony
- 6-4. The pretrial advice by the CO's staff judge advocate does NOT include which of the following elements?
1. Whether each specification alleges an offense
 2. Whether each allegation is substantiated by the evidence
 3. A recommended action by the convening authority
 4. A recommended punishment for the offense
- 6-5. A general court-martial should be comprised of at least how many members?
1. Six
 2. Seven
 3. Three
 4. Five
- 6-6. The effects of a BCD on the benefits of a veteran depend on which of the following factors?
1. Type of court-martial
 2. The facts of the case
 3. Who administers the benefits
 4. All of the above
- 6-7. A special-court martial may adjudge hard labor without confinement for a maximum of how many months?
1. 5
 2. 2
 3. 3
 4. 4
- 6-8. What term identifies a lump sum judgment against an accused payable to the United States?
1. Fine
 2. Charge
 3. Penalty
 4. Forfeiture

6-9. Automatic reduction to paygrade E-1 is effected upon what approved punishment?

1. Punitive discharge and confinement in excess of 90 days
2. Punitive discharge or confinement in excess of 90 days
3. Confinement in excess of 90 days or 3 months only
4. Confinement in excess of 30 days or 1 month only

6-10. The escalator clause permits a punitive discharge to those personnel involved in what type of cases?

1. Moral turpitude
2. Chronic offenders
3. Grievous bodily harm
4. Unauthorized absence of 1 year

6-11. What is the maximum sentence a special court-martial may award?

1. BCD, confinement for 3 months, and forfeiture of 1/2 pay per month for 6 months
2. BCD, confinement for 6 months, and forfeiture of 2/3 pay per month for 6 months, and reduction in rate to E-1
3. BCD, confinement for 6 months, and forfeiture of 3/4 pay per month for 6 months
4. BCD, confinement for 1 year, and forfeiture of 3/4 pay per month for 8 months, and reduction in rate to E-1

IN ANSWERING QUESTIONS 6-12 THROUGH 6-16, SELECT THE COUNSEL'S TACTIC FROM COLUMN B THAT MATCHES THE PURPOSE LISTED IN COLUMN A. RESPONSES MAY BE USED MORE THAN ONCE.

	<u>A. PURPOSE</u>	<u>B. COUNSEL'S TACTICS</u>
6-12.	An attempt to lead the witness	1. Friendly counsel
6-13.	To confuse the witness	2. Condescending counsel
6-14.	To give the impression that the witness is unreliable	3. Rapid fire questions 4. Suggestive
6-15.	To force inconsistent answers	
6-16.	To lull the witness into a false sense of security	
<hr/>		
6-17.	Procedures and directives for Masters-at-Arms personnel assigned to duty at courts-martial are set forth by which of the following authorities?	1. Type commander 2. Individual commands 3. Secretary of the Navy 4. Judge Advocate General
6-18.	When assigned to guard a prisoner in court, where should the MAA be stationed?	1. At the rear of the court 2. In a position to observe the prisoner 3. As directed by the defense counsel 4. At the bar facing the court

- 6-19. If a prisoner is delivered to a court in handcuffs, when, if ever, may the handcuffs be removed?
1. During the proceedings
 2. When the prisoner arrives
 3. When the prisoner enters the courtroom
 4. Never
- 6-20. Arrangements for the location of witnesses are made with whom?
1. The judge
 2. The court bailiff
 3. The defense counsel
 4. The trial counsel
- 6-21. During a trial, administrative errands are performed by whom?
1. The guard
 2. The court bailiff
 3. The messenger
 4. The MAA
- 6-22. Before and after each session of court the court bailiff receives specific instructions from whom?
1. The defense counsel
 2. The senior member
 3. The military judge
 4. The trial counsel
- 6-23. In the deliberation room, the bailiff performs which of the following duties?
1. Guards the entrance
 2. Ensures the court members have pencils and pads of voting paper
 3. Provides court papers for the defense and trial counsel
 4. Performs errands
- 6-24. When the military judge enters the courtroom, the bailiff makes what statement?
1. JUDGE _____, PRESIDING
 2. COURT IS IN SESSION
 3. EVERYONE PLEASE STAND
 4. ALL PERSONS PLEASE RISE
- 6-25. When the court members enter the courtroom, what announcement, if any, will the bailiff make?
1. ATTENTION ON DECK
 2. EVERYONE PLEASE STAND
 3. ALL PERSONS PLEASE RISE
 4. None
- 6-26. If a member of the news media insists on bringing a camera into the courtroom, the bailiff should report the incident to whom?
1. The guard
 2. The judge
 3. The trial counsel
 4. The senior court member
- 6-27. When court members are in closed session, who may enter the deliberation room?
1. The trial counsel
 2. The defense counsel
 3. The court members
 4. The bailiff
- 6-28. A court bailiff should be prepared to furnish which of the following services?
1. Summon witnesses
 2. Summon court members
 3. Collect written questions
 4. All of the above
- 6-29. Masters-at-Arms are assigned to civil court for which of the following reasons?
1. To ensure the civil courts treat the Armed Forces personnel fairly
 2. To act as an escort for the accused servicemember
 3. To record the court proceedings
 4. To establish and maintain a good working relationship between Armed Forces personnel and civil agencies

- 6-30. It is the duty of civil court liaison to use what resource(s) to learn of civil offenses committed by military personnel?
1. Civil police department only
 2. Civil police and military police only
 3. Military police and legal office only
 4. All available resources
- 6-31. Civil court liaison personnel perform which of the following duties?
1. Accept custody of military personnel released by civil authorities
 2. Maintain a written record of visits
 3. Initiate reports as required
 4. Each of the above
- 6-32. When, if ever, are working files of civilian court cases destroyed?
1. When the case is closed
 2. Six months after the case is closed
 3. One year after the case is closed
 4. Never
- 6-33. A Master-at-Arms, acting as a civilian court liaison, may be required to attend sessions of criminal and traffic courts.
1. True
 2. False
- 6-34. The basic laws of nonjudicial punishment may be found in which of the following sources?
1. Part V of the MCM
 2. Part B of the JAGMAN
 3. Article 15 of the UCMJ
 4. All of the above
- 6-35. Which of the following statements is correct concerning nonjudicial punishment (NJP)?
1. It is a forum for command members to air grievances
 2. The power to impose NJP is inherent in the individual
 3. It promotes positive behavior changes
 4. It is reserved for major offenses only
- 6-36. Ordinarily, the power to impose nonjudicial punishment cannot be delegated.
1. True
 2. False
- 6-37. What official must approve any limitation of authority by subordinate commanders under Article 15?
1. CNO
 2. SECDEF
 3. SECNAV
 4. CHNAVPERS
- 6-38. Which of the following personnel may be taken to mast by a Navy commander?
1. TSGT Brush, USAF
 2. SSGT Doe, USA
 3. MM3 Boate, USCG
 4. CPL Pistol, USMC
- 6-39. Under what circumstance, if any, may Reserve personnel be recalled to active duty for imposition of nonjudicial punishment that includes restraint?
1. When recalled by the CO of the Reserve center
 2. When the recall is approved by SECNAV
 3. When recalled for a time longer than the period of restraint
 4. None

- 6-40. A member's right to refuse imposition of nonjudicial punishment terminates at what time?
1. When the report chit is signed accepting mast
 2. When the rights acknowledgment is signed
 3. When the accused appears before the CO
 4. When the punishment is announced by the CO
- 6-41. The term "minor offense" means misconduct that is usually handled at which of the following courts-martial?
1. Summary
 2. Special
 3. General
- 6-42. Who makes the final determination as to whether or not an offense is considered minor?
1. Legal officer
 2. Division officer
 3. Executive officer
 4. Commanding officer
- 6-43. A commanding officer who has imposed nonjudicial punishment may not later refer the same case to a court-martial.
1. True
 2. False
- 6-44. A member may receive nonjudicial punishment after being tried by which of the following courts?
1. Juvenile court
 2. Federal district court
 3. Special court-martial
 4. General court-martial
- 6-45. Where can instructions be found for processing a Report and Disposition of Offense(s), NAVPERS Form 1626/7?
1. MCM
 2. JAGMAN
 3. BUPERSINST 1626.1
 4. On the form itself
- 6-46. The NAVPERS Form 1626/7 serves its purpose well but does not include which of the following information?
1. Records and premast restraint
 2. Preliminary inquiry report
 3. Premast advice
 4. Appeal rights
- 6-47. In what manner should witnesses be listed on the NAVPERS Form 1626/7?
1. Civilian witnesses and then military witnesses in order of seniority
 2. Military witnesses and then civilian witness in alphabetical order
 3. Military witnesses by seniority and then civilians
 4. Military and civilian witnesses in the order of involvement in the offense
- 6-48. If an accused refuses to sign the NAVPERS Form 1626/7 acknowledging the charges against him, what action should be taken?
1. The person informing the accused of the charges should sign for the accused
 2. The person informing the accused of the charges will sign to that fact
 3. The accused should be given a direct order to sign the form
 4. The form is forwarded without any signatures

- 6-49. In addition to the accused, who else must sign the premast restraint section of the NAVPERS Form 1626/7 when restriction is imposed?
1. The division officer
 2. The commanding officer
 3. The person informing the accused of the offense(s)
 4. The person imposing restraint
- 6-50. The accused's nonjudicial punishment notification and election of rights may be found in which of the following documents?
1. MCM
 2. UCMJ
 3. JAG Manual
 4. NAVPERS 1626/7
- 6-51. The term "Booker rights" includes which of the following rights?
1. The accused was offered an opportunity to talk with an attorney
 2. The accused was informed that acceptance of NJP does not prevent further administrative action
 3. The accused was offered an opportunity to demand trial by court-martial
 4. All of the above
- 6-52. At mast, the CO's determination of the accused's guilt is based on which of the following evidentiary foundations?
1. Preponderance of the evidence
 2. Probable circumstances
 3. Credible evidence
 4. Findings of fact
- 6-53. Which of the following statements is correct regarding the presence of personal representatives and witnesses at an NJP hearing?
1. Civilians may be subpoenaed to attend
 2. Witnesses from another command may be ordered to attend at their own expense
 3. The command holding the hearing must provide a personal representative
 4. A civilian lawyer may represent the accused
- 6-54. The results of NJP should be published not later than how long after imposition of punishment?
1. 1 wk
 2. 2 wk
 3. 1 mo
 4. 2 mo
- 6-55. Which of the following actions may be taken by a commanding officer at mast?
1. Refer the case to an Article 32 pretrial investigation
 2. Dismiss the case with a warning
 3. Postpone the action pending further investigation
 4. Each of the above
- 6-56. The NJP power of an OIC is limited to that of COs in which of the following paygrade ranges?
1. W1 to O2
 2. O1 and O2 only
 3. O2 and O3 only
 4. O1 to O3

- 6-57. An OIC may award an E-3 which of the following NJP punishments?
1. Correctional custody for 14 days
 2. Correctional custody for 7 days
 3. Restriction for 15 days
 4. Forfeiture of one-half of 1 month's pay for 1 month
- 6-58. A total of how many specific types of punishment may be awarded at mast?
1. Five
 2. Six
 3. Seven
 4. Eight
- 6-59. Procedures for issuing punitive letters may be found in which of the following publications?
1. MCM
 2. UCMJ
 3. JAGMAN
 4. MILPERSMAN
- 6-60. An officer placed on arrest or restriction will not be confined to quarters except under which of the following conditions?
1. The officer is stationed on board a ship
 2. The officer has been relieved of all duties
 3. The safety or the discipline of the ship requires it
 4. The officer is in paygrade O3 or below
- 6-61. Of the following statements, which one is correct concerning extra duties?
1. Guard duty may not be assigned as extra duty
 2. Extra duty must be performed during normal working hours
 3. Any type of duty may be assigned
 4. Extra duty should not be performed on holidays
- 6-62. Confinement on bread and water may be deferred for a maximum of how many days?
1. 7
 2. 15
 3. 30
 4. 180
- 6-63. A member submits an NJP appeal and requests that punishment involving restraint be stayed pending action on the appeal. If no action is taken on the appeal, how many days after the appeal was submitted will the stay take effect?
1. 5
 2. 7
 3. 3
 4. 15
- 6-64. Which of the following combinations of NJP punishment is acceptable?
1. Arrest in quarters and 10 days restriction
 2. Confinement on bread and water and 15 days extra duty
 3. Reduction in rate to E-2 and forfeiture of one-half of 1 month's pay per month for 2 months
 4. Correctional custody and 10 days extra duty
- 6-65. A CO who desires to set aside an NJP punishment should do so within what maximum number of months?
1. 1
 2. 6
 3. 3
 4. 4
- 6-66. A letter of notification setting aside an NJP should be signed by the CO and addressed to what command?
1. CNO
 2. NCIS
 3. TYCOM
 4. NAVPERS

- 6-67. A member serving an NJP punishment reaches his or her EAOS. What term identifies what happens to the unexecuted punishment?
1. Remission
 2. Mitigation
 3. Suspension
 4. Vindication
- 6-68. The punishment of reduction in rate to E-2 may be mitigated to what punishment?
1. Restriction
 2. Forfeiture of pay
 3. Correctional custody
 4. Confinement on bread and water
- 6-69. What term identifies an action to withhold punishment for a time pending the good behavior of an accused?
1. Remission
 2. Mitigation
 3. Suspension
 4. Vindication
- 6-70. Which of the following reasons may an accused properly use for an NJP appeal?
1. More than one punishment was awarded
 2. The punishment was unjust or disproportionate
 3. The accused was not represented by a lawyer
 4. The accused was damaged financially
- 6-71. To what official should an accused's NJP appeal letter be addressed?
1. Legal officer
 2. Area commander
 3. Area coordinator
 4. Staff judge advocate
- 6-72. An accused submits a letter of appeal and the CO takes corrective action based on the circumstances. After corrective action is taken, to whom should the appeal letter be forwarded?
1. The accused
 2. The reviewer
 3. The legal officer
 4. The division officer
- 6-73. The last endorsement to an appeal package is addressed to what official?
1. Legal officer
 2. CO of the accused
 3. Personnel officer
 4. Officer exercising general court-martial jurisdiction
- 6-74. An enlisted service member has been given an oral reprimand at mast. In addition to a service record entry, should the reprimand be documented elsewhere? If so, where?
1. Yes; notated on the report chit
 2. Yes; by letter to the division officer
 3. Yes; by letter to the legal officer
 4. No
- 6-75. If your command does not have the facilities to impose restriction, what action should your command take?
1. Defer the punishment until facilities are in place
 2. Mitigate the punishment
 3. Suspend the punishment
 4. Send the accused to the nearest command with the appropriate facilities

ASSIGNMENT 7

Textbook Assignment: "Nonjudicial Punishment (continued)," and "Controlled Substances," chapters 6 and 7, pages 6-37 through 7-16.

- 7-1. The results of mast on an officer are officially recorded in what manner?
1. Page 13 entry in the service record
 2. Page 7 entry in the service record
 3. By submission of a special fitness report on the officer
 4. Letter report to PERS-82 via the first flag officer in the chain of command
- 7-2. The unit punishment book contains a record of all NJP hearings conducted by a command.
1. True
 2. False
- 7-3. When should the NAVPERS Form 1626/7 be used for the entry in the unit punishment book?
1. When all service record entries have been made
 2. When the accused has served all imposed punishment
 3. When all administrative actions have been completed
 4. When the punishment has been published in the POD
- 7-4. When a CO refers a case from mast to a court-martial, what service record entry, if any, must be made?
1. Page 2 entry
 2. Page 9 entry
 3. Page 13 entry
 4. None
- 7-5. When a forfeiture is imposed at NJP, what enlisted service record pages must be prepared?
1. 7 and 9 only
 2. 6, 9, and 13 only
 3. 7, 9, and 13 only
 4. 6, 7, 9, and 13
- 7-6. Drug abuse has a particularly important consequence for the Armed Forces for what reason?
1. Members of the Armed Forces have a special dependency on each other
 2. The punishment for drug abuse in the military service is more severe
 3. The military services invest a great deal in training personnel
 4. Drug abuse is under a different set of laws in the Armed Forces
- 7-7. What year did the Navy change its drug policy to fully support a zero tolerance to drug abuse?
1. 1979
 2. 1982
 3. 1987
 4. 1992
- 7-8. What is the maximum punishment for the possession of Schedule IV and V controlled substances?
1. Confinement for 5 years and a dishonorable discharge
 2. Confinement for 5 years and a bad conduct discharge
 3. Confinement for 10 years and a dishonorable discharge
 4. Confinement for 10 years and a bad conduct discharge

7-9. Which of the following approaches to the potential drug abuser is becoming recognized as a valuable tool in fighting the drug problem?

1. Administrative discharge
2. Punitive action
3. Peer pressure
4. Education

7-10. Of the following drugs, which one is an example of an abused nonnarcotic drug?

1. Opium
2. Heroin
3. Morphine
4. Amphetamines

7-11. The Drug Abuse Control Amendments were added to the Food, Drug, and Cosmetic Act during what year?

1. 1938
2. 1962
3. 1965
4. 1966

7-12. The purpose of the Drug Abuse Control Amendments was to eliminate traffic in which of the following drugs?

1. Amphetamines and barbiturates only
2. Amphetamines, barbiturates, and marijuana only
3. Marijuana only
4. Narcotics and nonnarcotics

7-13. The Bureau of Narcotics and Dangerous Drugs (BNDD) is now known as what agency?

1. ATF
2. DEA
3. FDA
4. NCIS

7-14. Since 1968, drug abuse has grown at an especially high rate in which of the following countries?

1. France
2. Japan
3. Mexico
4. United States

IN ANSWERING QUESTIONS 7-15 THROUGH 7-19, SELECT THE TERM FROM COLUMN B THAT MATCHES THE DESCRIPTION IN COLUMN A. RESPONSES MAY BE USED ONCE, MORE THAN ONCE, OR NOT AT ALL.

<u>A. DESCRIPTIONS</u>	<u>B. TERMS</u>
7-15. Opium and heroin	1. Hypnotic
7-16. Nonnarcotic substances having a potential for abuse because of their depressant or stimulant effect on the central nervous system	2. Dangerous drugs
7-17. A sleep-inducing agent	3. Narcotics
7-18. An agent that quiets activity	4. Sedative
7-19. Methadone	

7-20. Stimulants are used to treat which of the following medical problems?

1. Tension
2. Anxiety
3. Overweight
4. Malnutrition

7-21. Which of the following types of drugs calm and sedate?

1. Stimulants
2. Depressants
3. Both 1 and 2 above
4. Hallucinogens

7-22. Distortions of time, space, and sound are sometimes caused by which of the following types of drugs?

1. Hallucinogens
2. Depressants
3. Stimulants
4. Hypnotic

7-23. Delirium is characterized by which of the following conditions?

1. Sleep
2. Vomiting
3. Mental excitement
4. Violent muscle contraction

7-24. A person who illegally used drugs for kicks falls under what category of drug abuse?

1. Drug tolerant
2. Drug compulsive
3. Drug addict
4. Drug user spree

7-25. A drug addict's activities revolve almost entirely around drug experiences and securing supplies.

1. True
2. False

7-26. To be termed a drug addict, a person must have which of the following conditions present?

1. A tolerance for the drug
2. A psychological or compulsive dependence
3. Withdrawal symptoms in the absence of the drug
4. Each of the above

7-27. Physiological adaptation of the body to the presence of the drug is described by what term?

1. Drug abuse
2. Drug dependence
3. Physical dependence
4. Psychological dependence

7-28. An attachment to drug use that arises from a drug's ability to satisfy some emotional need of an individual is known by what term?

1. Drug abuse
2. Drug dependence
3. Physical dependence
4. Psychological dependence

7-29. Which of the following terms describes a major mental disorder?

1. Psychosis
2. Delirium
3. Convulsions
4. Narcosis

IN ANSWERING QUESTIONS 7-30 THROUGH 7-34, SELECT THE TERM FROM COLUMN B THAT MATCHES THE DESCRIPTION IN COLUMN A. RESPONSES MAY BE USED ONCE, MORE THAN ONCE, OR NOT AT ALL.

	<u>A. DESCRIPTIONS</u>	<u>B. TERMS</u>
7-30.	A state arising from repeated administrations of a drug	1. Potentiation
7-31.	A need to increase the dosage of drugs to maintain the same effect	2. Habituation
7-32.	When the combined action of two or more drugs is greater than the sum of the effects of each drug taken alone	3. Drug dependence
7-33.	As a result of the repeated consumption of a drug, a condition that includes little or no tendency to increase the dose	4. Tolerance
7-34.	Can be very useful in certain medical procedures, but may also be dangerous	

7-35. A person who wrongfully furnishes another person small quantities of illegal drugs, more for the convenience of the user than profit, is known by what term?

1. Supplier
2. Small dealer
3. Casual supplier
4. Experimental dealer

7-36. Which of the following is a way to place a controlled substance on the FSCA?

1. Administrative acts passed by Congress
2. Legislative acts passed by Congress
3. Both 1 and 2 above
4. Administrative procedures through DEA

7-37. What act, passed by Congress in 1988, allows for the regulation of certain chemicals used in the making of controlled substances?

1. Federal Controlled Substance Act
2. Chemical Diversion and Trafficking Act
3. Comprehensive Drug Abuse Act
4. Chemical and Substance Abuse Prevention Act

7-38. Under 21 USC Section 811, the FSCA classified drugs into a total of how many schedules?

1. 5
2. 8
3. 10
4. 12

7-39. Which of the following sources may petition to add, delete, or change the schedule of a drug?

1. A drug manufacturer
2. A government agency
3. A medical society
4. Each of the above

7-40. Which of the following factors determines the schedule in which a drug or other substance should be placed?

1. The drug's potential for abuse
2. The scientific evidence of the drug's pharmacological effects
3. The scope, duration, and significance of abuse
4. All of the above

IN ANSWERING QUESTIONS 7-41 THROUGH 7-44, SELECT THE SCHEDULE FROM COLUMN B THAT MATCHES THE DESCRIPTION IN COLUMN A. RESPONSES MAY BE USED ONCE, MORE THAN ONCE, OR NOT AT ALL.

	<u>A. DESCRIPTIONS</u>	<u>B. SCHEDULE</u>
7-41.	Has a currently accepted medical use with severe restrictions	1. I 2. II 3. III
7-42.	Has no currently accepted medical use in treatment	4. IV
7-43.	Abuse of drug may lead to limited psychological dependence	
7-44.	Abuse of drug may lead to moderate physical dependence	

7-45. Drugs that have the lowest potential for abuse are found under what schedule?

1. I
2. II
3. V
4. IV

- 7-46. When DEA determines that a drug or substance be controlled, a proposal is published in which of the following books?
1. Federal Register
 2. Drug Abuse and Their Signs
 3. Physician's Desk Reference
 4. Federal Drug Control Manual
- 7-47. Once the final order is published in the Federal Register, interested parties have a maximum of how many days to appeal the scheduling of a drug?
1. 15
 2. 30
 3. 60
 4. 90
- 7-48. In 1984, what act amended the FCSA to allow the administrator of the DEA to temporarily place a substance into schedule I?
1. Dangerous Drugs Act
 2. Drug Enforcement Act
 3. Controlled Narcotics Act
 4. Comprehensive Crime Control Act
- 7-49. May a temporary scheduling order be extended? If so, for a maximum of how long?
1. Yes; 2 mo
 2. Yes; 4 mo
 3. Yes; 6 mo
 4. No
- 7-50. What 1986 act created a new class of substances known as controlled substance analogues?
1. Anti-Drug Abuse Act
 2. Comprehensive Crime Control Act
 3. Controlled Substance Act
 4. Dangerous Drugs Act
- 7-51. In what year did Congress ratify the treaty, Convention on Psychotropic Substances?
1. 1971
 2. 1975
 3. 1980
 4. 1989
- 7-52. Any person who handles controlled substances must obtain a registration issued by the DEA.
1. True
 2. False
- 7-53. FCSA requires that all controlled substances be inventoried at least how often?
1. 30 days
 2. 6 mo
 3. 1 yr
 4. 2 yr
- 7-54. Which of the following schedules of drugs requires the supplier to have a special order form from the customer?
1. I
 2. II
 3. Both 1 and 2 above
 4. V
- 7-55. The determination to place drugs on a prescription is within whose jurisdiction?
1. AMA
 2. DEA
 3. FDA
 4. HHS
- 7-56. Of the following drug schedule combinations, which one must be stored in specially constructed vaults?
1. I and II
 2. I and III
 3. II and IV
 4. III and V

- 7-57. Of the following drug properties, which one basically determines the federal trafficking penalties?
1. The quality
 2. The schedule
 3. The weight
 4. The purpose
- 7-58. An MA wishing to identify a tablet should consult what section of the Physicians Desk Reference (PDR)?
1. Table
 2. Product
 3. Manufacturer
 4. Reference
- 7-59. What type of book is the PDR?
1. Drug abuse guide
 2. Pharmaceutical catalog
 3. Medical reference book
 4. Medical identification manual
- 7-60. When comparing a capsule to the photos in the PDR, should one always assume that the contents of the capsule are those supplied by the manufacturer.
1. True
 2. False
- 7-61. MAs most commonly obtain a PDR in which of the following ways?
1. By obtaining a preceding year's copy from a physician
 2. From a local NCIS office
 3. By subscription
 4. From a Navy hospital
- 7-62. The stimulant cocaine is a narcotic by legal definition.
1. True
 2. False
- 7-63. When used as an analgesic, narcotics provide what type of relief, if any?
1. Physical only
 2. Psychic only
 3. Physical and psychic
 4. None
- 7-64. To say someone is "skin-popping" means that an individual is injecting in what way?
1. Intravenously
 2. Intramuscularly
 3. Intravascularly
 4. Subcutaneously
- 7-65. Narcotics tend to have which of the following physical effects on users?
1. Increased physical activity
 2. Reduced vision
 3. Enlarged pupils
 4. Diarrhea
- 7-66. When a user of narcotics is deprived of the drug, when are the first withdrawal signs experienced?
1. Shortly before the next scheduled dose
 2. Shortly after the next scheduled dose
 3. Several hours after the next scheduled dose
 4. At least 1 day after the next schedule dose
- 7-67. Without treatment, withdrawal symptoms disappear in how many days?
1. 3 to 5
 2. 4 to 6
 3. 7 to 10
 4. 12 to 14

7-68. Because drug addicts tend to neglect themselves, they often suffer from which of the following disorders?

1. Malnutrition
2. Infection
3. Injury
4. Each of the above

7-69. The main source of nonsynthetic narcotics is from what plant?

1. Mushroom
2. Fern
3. Coca
4. Poppy

7-70. What type of odor, if any, does raw opium have?

1. Musty
2. Sweet
3. Pungent
4. None

7-71. Morphine is derived from what source?

1. Heroin
2. Opium
3. Codeine
4. Paregoric

7-72. On the illicit market, morphine usually appears in which of the following forms?

1. Powder
2. Tablet
3. Liquid
4. Capsule

7-73. Morphine has what type of odor, if any?

1. Musty
2. Sweet
3. Pungent
4. None

7-74. Codeine is found in the market in which of the following forms?

1. Tablet
2. Liquid
3. Capsule
4. All of the above

7-75. Thebaine produces a depressant effect.

1. True
2. False

ASSIGNMENT 8

Textbook Assignment: "Controlled Substances," chapter 7, pages 7-16 through 7-27.

8-1. Of the following substances, which one is morphine-like and usually appears as a crystalline white powder?

1. Opium
2. Heroin
3. Thebaine
4. Oxycodone

8-2. In its pure form, heroin is how many times stronger than morphine?

1. 1 to 3
2. 2 to 4
3. 4 to 5
4. 6 to 10

8-3. Heroin entering the United States from Europe is usually of what maximum purity?

1. Under 75 percent
2. 75 to 80 percent
3. 80 to 85 percent
4. Over 90 percent

IN ANSWERING QUESTIONS 8-4 THROUGH 8-8, SELECT THE SEMISYNTHETIC NARCOTIC FROM COLUMN B THAT MATCHES THE DESCRIPTION IN COLUMN A. RESPONSES MAY BE USED ONCE, MORE THAN ONCE, OR NOT AT ALL.

<u>A. DESCRIPTIONS</u>	<u>B. SEMI-SYNTHETIC NARCOTICS</u>
8-4. Most commonly injected narcotic	1. Paregoric
8-5. Dilaudid	2. Oxycodone
8-6. Potency is from 2 to 8 times greater than morphine	3. Hydromorphone
8-7. Synthesized from Thebaine	4. Heroin
8-8. Usually taken for relief of diarrhea	

8-9. What are the two most widely available synthetic drugs?

1. Methadone and LAAM
2. Methadone and meperidine
3. Meperidine and LAAM
4. Meperidine and Darvon

8-10. Which of the following is a commercial name for pethidine?

1. Propoxyphene
2. Demerol
3. Darvon
4. LAAM

- 8-11. The effects of morphine-based drugs differ from methadone in what way?
1. Methadone has a shorter duration of action
 2. Methadone has a longer duration of action
 3. Methadone will not cause dependence as do morphine-based drugs
 4. Methadone is always taken orally; morphine-based drugs are always injected
- 8-12. Fentanyl has a clinical potency of how many times that of morphine?
1. 5 to 10
 2. 10 to 20
 3. 35 to 40
 4. 50 to 100
- 8-13. How many different types of fentanyls are approved for marketing in the United States?
1. 25
 2. 12
 3. 7
 4. 4
- 8-14. Fentanyl falls into what schedule of the FSCA?
1. I
 2. II
 3. V
 4. IV
- 8-15. The biological effects of fentanyls are indistinguishable from which of the following drugs?
1. Cocaine
 2. Heroin
 3. Morphine
 4. Opium
- 8-16. Fentanyls produce pharmacological effects characteristic of which of the following drugs?
1. Cocaine
 2. Heroin
 3. Morphine
 4. Opiates
- 8-17. Fentanyl users experience the first effects within a maximum of how many seconds after intravenous administration?
1. 30
 2. 45
 3. 60
 4. 90
- 8-18. 3-methylfentanyl has a duration of action of approximately how many hours?
1. 12
 2. 8
 3. 6
 4. 4
- 8-19. Fentanyls are most commonly taken by which of the following methods?
1. Ingestion
 2. Intravenous
 3. Intranasal
 4. Smoked
- 8-20. Street samples of fentanyls usually do not have a distinctive color, odor, or taste.
1. True
 2. False
- 8-21. Fentanyl plasma levels above how many nanograms per milliliter are associated with respiratory depression?
1. .10 to .20
 2. .30 to .40
 3. .50 to 1
 4. 2 to 3

- 8-22. Respiratory depression caused by fentanyl can be quickly and effectively reversed by administering which of the following drugs?
1. Methadone
 2. Mannitol
 3. Naloxone
 4. Xanax
- 8-23. Prescribed depressants are sometimes helpful in the relief of which of the following disorders?
1. Shock
 2. Tension
 3. Fatigue
 4. Infection
- 8-24. Intoxicating doses of depressants may cause which of the following effects?
1. Slurred speech
 2. Impaired judgement
 3. Loss of motor coordination
 4. All of the above
- 8-25. Chronic intoxication caused by the use of depressants is most common in what age group?
1. Adolescent
 2. Young adult
 3. Middle age
 4. Elderly
- 8-26. Which of the following is a symptom of severe depressant poisoning?
1. Fever
 2. Vomiting
 3. Diarrhea
 4. Rapid pulse
- 8-27. Of the following drugs, which one is most sought after by depressant abusers?
1. Seconal
 2. Luminal
 3. Gemonil
 4. Mebaral

- 8-28. After oral administration of an intermediate-acting barbiturate, what is the approximate action time, in minutes?
1. 1 to 3
 2. 5 to 10
 3. 15 to 40
 4. 45 to 60
- 8-29. Barbiturates can be very dangerous because tolerance and mental and physical dependence develop.
1. True
 2. False
- 8-30. Barbiturates are most often taken in which of the following forms?
1. Powder
 2. Liquid
 3. Capsule
 4. Injection

IN ANSWERING QUESTIONS 8-31 THROUGH 8-34, SELECT THE DEPRESSANT FROM COLUMN B THAT MATCHES THE DESCRIPTION IN COLUMN A. RESPONSES MAY BE USED ONCE, MORE THAN ONCE, OR NOT AT ALL.

	<u>A. DESCRIPTIONS</u>	<u>B. DEPRESSANTS</u>
8-31.	Exceptionally difficult to reverse overdoses, often resulting in death	1. Benzodiazepines
8-32.	Miltown	2. Glutethimide
8-33.	Duration of action similar to intermediate-acting barbiturates	3. Barbiturate
8-34.	Margin of safety is greater than other depressants	4. Meprobamate

- 8-35. What are the two most prevalent stimulants?
1. Nicotine and caffeine
 2. Nicotine and cocaine
 3. Caffeine and cocaine
 4. Cocaine and amphetamines
- 8-36. Users sometimes rely on stimulants for which of the following reasons?
1. To become relaxed
 2. To be more decisive
 3. To reduce apprehension
 4. To reduce irritability
- 8-37. The use of stimulants may cause which of the following effects on a user?
1. Anxiety
 2. Serenity
 3. Drowsiness
 4. Increased appetite
- 8-38. The protracted use of stimulants is normally followed by a period of depression known by what term?
1. Flashing
 2. Rushing
 3. Crashing
 4. Splashing
- 8-39. Heavy users who inject themselves with stimulants every few hours may experience which of the following effects?
1. Delirium
 2. Psychosis
 3. Physical exhaustion
 4. Each of the above
- 8-40. When high-dose users are withdrawn from stimulants, they exhibit profound depression for up to how many hours per day?
1. 8
 2. 12
 3. 18
 4. 20
- 8-41. Cocaine is often adulterated to what percentage of its volume?
1. 10
 2. 25
 3. 50
 4. 60
- 8-42. Cocaine is most often adulterated with which of the following ingredients?
1. Sugar
 2. Flour
 3. Baking soda
 4. Talcum
- 8-43. To convert cocaine to a base for freebasing, what substance is used?
1. Lard
 2. Solvent
 3. Soap powder
 4. Carbon dioxide
- 8-44. Cocaine is popularly accepted as what kind of drug?
1. Psychic
 2. Tolerant
 3. Recreational
 4. Hallucinogenic
- 8-45. Tolerance seldom develops among cocaine users.
1. True
 2. False
- 8-46. Excessive doses of cocaine may cause which of the following disorders?
1. Cancer
 2. Seizures
 3. High blood pressure
 4. Each of the above

- 8-47. Combination shots of cocaine, heroin, and morphine are known by what term?
1. Speed
 2. Speedballs
 3. Free basing
 4. Triple trouble
- 8-48. What method is used to free base traditional cocaine?
1. Smoked through a water pipe
 2. Inhaled through the nose
 3. Injected intravenously
 4. Ingested orally
- 8-49. Which of the following substances is NOT used in the processing of crack?
1. Baking soda
 2. Ammonia
 3. Water
 4. Ether
- 8-50. The euphoria caused by crack has been known to last how long?
1. 2 to 20 min
 2. 30 to 60 min
 3. 60 to 90 min
 4. 2 to 7 hr
- 8-51. Overdoses caused by either cocaine free base or crack can cause which of the following disorders?
1. Stroke
 2. Seizures
 3. Respiratory distress
 4. Fatal cardiorespiratory arrest
- 8-52. Of the following behaviors, which one(s) may persons on crack potentially exhibit?
1. Violent
 2. Suicidal
 3. Both 1 and 2 above
 4. Invincible
- 8-53. What is the name of the drug that is known as the designer drug of the 1980's?
1. Cocaine
 2. Ecstasy
 3. Crack
 4. Ice
- 8-54. Ecstasy has been around for at least how many years?
1. 10
 2. 20
 3. 50
 4. 75
- 8-55. Ecstasy was initially meant to be used for which of the following disorders?
1. Acne
 2. Diabetes
 3. Hypertension
 4. Obesity
- 8-56. Which of the following is a street name for ecstasy?
1. M&M
 2. Adam
 3. Yuppie drug
 4. Each of the above
- 8-57. MDMA produces psychotic states that may last for up to how long?
1. Days
 2. Hours
 3. Weeks
 4. Years
- 8-58. Ecstasy has the same effects as which of the following drugs?
1. Amphetamine plus crack
 2. LSD plus an amphetamine
 3. Cocaine plus a barbiturate
 4. Cannabis plus methamphetamine

- 8-59. Is ecstasy addictive? If so, how long does it take?
1. Yes; a long period of time
 2. Yes; a short period of time
 3. No
- 8-60. When was methcathinone placed under Schedule I of the FSCA?
1. June 1991
 2. March 1971
 3. October 1993
 4. February 1989
- 8-61. Methcathinone produces central nervous system stimulant effects similar to which of the following drugs?
1. Cocaine
 2. Amphetamine
 3. Both 1 and 2 above
 4. Alcohol
- 8-62. Which of the following is a street name for methcathinone?
1. Cat
 2. Goob
 3. Crank
 4. Each of the above
- 8-63. What color is methcathinone when it is sold on the street?
1. Tan to dark brown
 2. Tan to light brown
 3. White to off white
 4. Gray to dark black
- 8-64. What is the primary route of administration of methcathinone?
1. Smoking
 2. Intranasal
 3. Intravenous
 4. Oral ingestion
- 8-65. Methcathinone is primarily used in a binge that lasts about how many days?
1. 1 to 4
 2. 2 to 7
 3. 6 to 12
 4. 10 to 14
- 8-66. When a person repeatedly administers methcathinone during a binge, what is the average dose, in grams?
1. 1/16 to 1/4
 2. 1/2 to 3/4
 3. 1 to 1 1/2
 4. 2 to 4
- 8-67. The methcathinone produced by clandestine laboratories is what percent pure?
1. 20 to 30
 2. 40 to 50
 3. 55 to 75
 4. 95 to 100
- 8-68. The legal use of amphetamines is limited to the treatment of what disorder?
1. Epilepsy
 2. Narcolepsy
 3. Eating disorders
 4. High blood pressure
- 8-69. Of the following stimulants, which one, if any, acts like adrenalin on the body?
1. Cocaine
 2. Preludin
 3. Amphetamines
 4. None of the above
- 8-70. Amphetamines are widely used by which of the following persons to increase alertness?
1. Truck drivers
 2. Night watchmen
 3. Both 1 and 2 above
 4. School teachers

8-71. Amphetamines are most often taken in what manner?

1. Smoked
2. Snorted
3. Injected
4. Orally

8-72. Amphetamine abuse causes what type(s) of dependence, if any?

1. Mental only
2. Physical only
3. Mental and physical
4. None

8-73. Clandestine laboratories produce a vast quantity of which of the following amphetamines?

1. Ritalin
2. Preludin
3. Benzedrine
4. Methamphetamine

8-74. Methamphetamine appears in which of the following forms?

1. Capsule and tablet only
2. Tablet and liquid only
3. Liquid and powder only
4. Capsule, tablet, liquid, and powder

8-75. Methamphetamine abusers are known by which of the following terms?

1. Speedballers
2. Speed freaks
3. Bam bams
4. Copilots

ASSIGNMENT 9

Textbook Assignment: "Controlled Substances," chapter 7, pages 7-22 through 7-40.

-
- 9-1. Methamphetamine use may cause which of the following effects?
1. Depression
 2. Impudent behavior
 3. Low blood pressure
 4. Impaired sexual potency
- 9-2. An abuser on a "speed run" injects methamphetamine how often?
1. Once a day
 2. Once each hour
 3. Twice each hour
 4. As often as necessary to feel the desired results
- 9-3. During a "speed run," the abuser usually does not eat or sleep.
1. True
 2. False
- 9-4. After a "speed run," the abuser usually sleeps for how many hours?
1. 6 to 12
 2. 18 to 24
 3. 24 to 48
 4. 36 to 60
- 9-5. What is another name for crystal methamphetamine?
1. Ice
 2. Crack
 3. Ecstasy
 4. Free base
- 9-6. Methamphetamine is also available in crystal form similar to which of the following substances?
1. Rock candy
 2. Hawaiian salt
 3. Both 1 and 2 above
 4. Table salt
- 9-7. A person can obtain approximately how many hits from 1 gram of ice?
1. 2 to 5
 2. 6 to 9
 3. 10 to 15
 4. 20 to 30
- 9-8. When water-based ice is smoked, what color residue is left on the inside of the pipe bowl?
1. Black
 2. Brownish
 3. Yellowish
 4. Milky white
- 9-9. Oil-based ice leaves what color of residue on the inside of the pipe?
1. Grey
 2. Brownish
 3. Yellowish
 4. Milky white
- 9-10. The effects of ice may last up to how long from a single dose?
1. 10 to 30 min
 2. 45 to 60 min
 3. 2 to 8 hr
 4. 4 to 6 hr
- 9-11. Large doses of ice may be excreted into the urine, unchanged, up to how many hours after ingestion?
1. 72
 2. 96
 3. 120
 4. 130
- 9-12. Which of the following items are common carriers for meth?
1. Paper bindles
 2. Opaque glass vials
 3. Heat-sealed cellophane packets
 4. All of the above

9-13. The basic difference between a pipe used for cocaine and one used for meth is in the construction of the pipe.

1. True
2. False

9-14. Which of the following is a telltale sign of a meth user?

1. Tracks
2. Runny nose
3. Impaired speech
4. Burn marks on fingers

- | |
|---|
| <ol style="list-style-type: none">A. CocaineB. AmphetamineC. MethamphetamineD. PhenmetrazineE. CrackF. EcstasyG. MethcathinoneH. Crystal methamphetamine |
|---|

Figure 9-A

IN ANSWERING QUESTIONS 9-15 THROUGH 9-25, SELECT THE STIMULANT FROM FIGURE 9-A THAT MATCHES THE DESCRIPTION GIVEN AS THE QUESTION. RESPONSES MAY BE USED MORE THAN ONCE.

9-15. Most potent stimulant of natural origin.

1. A
2. C
3. E
4. F

9-16. The fascination with this drug lies in the initial effect.

1. B
2. C
3. D
4. H

9-17. Sprinkled on marijuana or tobacco cigarettes.

1. D
2. E
3. G
4. H

9-18. Subject to abuse in countries where freely available.

1. D
2. E
3. F
4. G

9-19. Any amount can produce ill effects and physical or psychological manifestations.

1. A
2. E
3. F
4. H

9-20. The duration of the high is several hours and will depend upon the dose given.

1. A
2. B
3. G
4. H

9-21. Known by the term "speed."

1. B
2. C
3. E
4. G

9-22. Most commonly "snorted."

1. A
2. D
3. F
4. G

9-23. Referred to as rock methamphetamine.

1. A
2. E
3. G
4. H

- 9-24. Smoking this substance is a more serious problem than snorting cocaine HCL.
1. C
 2. D
 3. E
 4. F
- 9-25. Excessive use may lead to permanent brain damage.
1. B
 2. F
 3. G
 4. H
-
- 9-26. Abusers of preludein normally administer the drug by what method?
1. Orally only
 2. Injection or snorting
 3. Orally or injecting
 4. Snorting or smoking
- 9-27. What type of drugs has been manufactured to replace amphetamines as appetite suppressants?
1. Look-alikes
 2. Euphorics
 3. Semi-narcotics
 4. Anorectics
- 9-28. Do anorectic drugs differ from amphetamines? If so, in what way?
1. Yes; anorectics are more potent
 2. Yes; anorectics are less potent
 3. Yes; anorectics are not controlled
 4. No
- 9-29. Low doses of what anorectic drug produces sedation?
1. Fenfluramine
 2. Pre-Sate
 3. Melfiate
 4. Tandrec
- 9-30. A person under the influence of hallucinogens experiences which of the following symptoms?
1. A decrease in pulse rate
 2. Lower blood pressure
 3. A drop in body temperature
 4. A rise in body temperature
- 9-31. What is the most common danger in the abuse of hallucinogens?
1. Depression
 2. Depersonalization
 3. Impaired judgement
 4. Visual hallucinations
- 9-32. Long after hallucinogens are eliminated from the body, users may experience what effect?
1. Flashbacks
 2. Restlessness
 3. Acute anxiety
 4. Sleeplessness
- 9-33. Hallucinogens are predictable in their effects each time they are used.
1. True
 2. False
- 9-34. LSD is derived from what source?
1. Mushrooms
 2. Solvent
 3. Fungus
 4. Cactus
- 9-35. What color, if any, is LSD in its pure liquid state?
1. Blue
 2. Yellow
 3. Purple
 4. Colorless
- 9-36. Spots of LSD on paper squares are described by what term?
1. Dots
 2. Crackers
 3. Window panes
 4. Blotter acid

9-37. What is the average effective oral dose of LSD, in micrograms?

1. 10 to 20
2. 20 to 30
3. 30 to 50
4. 35 to 55

9-38. Mescaline is derived from what source?

1. Opium
2. Cactus
3. Fungus
4. Mushrooms

9-39. Mescaline is popular among the drug culture for what reason?

1. It is inexpensive
2. It is readily available
3. It is thought to be safe
4. Its effects are easily masked

9-40. Hallucinations produced from mescaline last up to how many hours?

1. 1 to 2
2. 2 to 6
3. 5 to 12
4. 10 to 18

IN ANSWERING QUESTIONS 9-41 THROUGH 9-45, SELECT THE HALLUCINOGEN FROM COLUMN B THAT MATCHES THE DESCRIPTION IN COLUMN A. RESPONSES MAY BE USED MORE THAN ONCE.

	<u>A. DESCRIPTION</u>	<u>B. HALLUCINOGENS</u>
9-41.	Obtained from mushrooms	1. Psilocybin
		2. Bufotenin
9-42.	Derived from seeds of certain plants native to the West Indies	3. Diethyltryptamine (DET)
		4. Dimethyltryptamine (DMT)
9-43.	Not usually taken orally	
9-44.	Derived from certain toads	
9-45.	Not yet found in plant life	
<hr/>		
9-46.	STP is how many times more powerful than mescaline?	
		1. 20
		2. 100
		3. 150
		4. 200
9-47.	The "magic pumpkin seed" is a street name for what hallucinogen?	
		1. STP
		2. DOM
		3. DET
		4. DMT
9-48.	What color is PCP in its pure form?	
		1. Tan
		2. White
		3. Brown
		4. Black

- 9-49. What is the most common method for using PCP?
1. Smoked
 2. Snorted
 3. Injected
 4. Orally ingested
- 9-50. What is the active ingredient in cannabis?
1. DET
 2. DMT
 3. CSA
 4. THC
- 9-51. Loosely rolled cannabis cigarettes are referred to by which of the following terms?
1. Joints
 2. Butts
 3. Sticks
 4. Reeds
- 9-52. The use of cannabis in very high doses may cause what condition?
1. A loss of personal identity
 2. Image distortions
 3. Toxic psychosis
 4. Impaired memory
- 9-53. Cannabis products are under what schedule of the FCSA?
1. I
 2. II
 3. III
 4. IV
- 9-54. What is the most "selective" marijuana?
1. Jamaican
 2. Sinsemilla
 3. Columbian
 4. Mexican
- 9-55. The average potency of hashish in the United States is what percent?
1. 0.5
 2. 1.8
 3. 6.9
 4. 7.5
- 9-56. Anabolic steroids as a group fall into what schedule of the FCSA?
1. I
 2. V
 3. III
 4. IV
- 9-57. Navy service members who unlawfully disburse anabolic steroids are guilty of violating what article of the UCMJ?
1. 90
 2. 92
 3. 112a
 4. 134b
- 9-58. Anabolic steroids are considered synthetic derivatives of testosterone, the naturally occurring male sex hormone.
1. True
 2. False
- 9-59. Anabolic steroids are particularly important in the treatment of which of the following medical conditions?
1. Strokes
 2. Hypogonadism
 3. Kidney failure
 4. High blood pressure
- 9-60. Which of the following characteristics is/are overt signs of anabolic steroid abuse?
1. Mood swings
 2. Facial puffiness
 3. Excellent muscular build
 4. All of the above

- 9-61. Fingernail polish remover is not a volatile solvent.
1. True
 2. False
- 9-62. Manufacturers have added which of the following products to their glue formulas to curb glue sniffing?
1. Nitrous oxide
 2. Mustard
 3. Freon
 4. Oil
- 9-63. Which of the following items of abuse is of the belladonna family?
1. Nutmeg
 2. Jimson weed
 3. Morning glory seeds
 4. Hawaiian baby wood rose
- 9-64. Some morning glory seeds contain lysergic acid amide.
1. True
 2. False
- 9-65. Look-alikes are manufactured to resemble or duplicate which of the following abused drugs?
1. Narcotic pain killers
 2. Tranquilizers
 3. Amphetamines
 4. Each of the above
- 9-66. Look-alike manufacturers distribute look-alikes that contain controlled substances.
1. True
 2. False
- 9-67. A program to control look-alikes has been undertaken by what agency?
1. DEA
 2. FBI
 3. NCIS
 4. AFT
- 9-68. Which of the following is a slang term for LSD?
1. Mud
 2. Mota
 3. Mujer
 4. Microdot
- 9-69. Nose candy is a slang term for which of the following drugs?
1. Amphetamines
 2. Barbiturates
 3. Cocaine
 4. LSD
- 9-70. Of the following terms, which one is slang for heroin?
1. Dirt
 2. Haze
 3. Herb
 4. Ganja

IN ANSWERING QUESTIONS 9-71 THROUGH 9-75, SELECT THE DRUG FROM COLUMN B THAT MATCHES THE SLANG TERM IN COLUMN A. RESPONSES MAY BE USED MORE THAN ONCE.

	<u>A. SLANG TERMS</u>	<u>B. DRUGS</u>
9-71.	Uppers	1. Barbiturates
9-72.	Christmas Trees	2. Phencyclidine
9-73.	Elephant	3. Amphetamines
9-74.	Tea	4. Marijuana
9-75.	Mexican Reds	

ASSIGNMENT 10

Textbook Assignment: "Controlled Substances (continued)," and "Small Arms," chapters 7 and 8, pages 7-42 through 8-28.

- 10-1. Which of the following methods is used to determine supply outlets of illicit drugs?
1. Informants
 2. Surveillance
 3. Direct purchase
 4. Each of the above
- 10-2. Immediately after using an informant on an illicit drug purchase, which of the following actions should you take?
1. Give the informant any money that is left over
 2. Conduct a strip search of the informant
 3. Tell the informant to be available for testimony
 4. Keep the informant under surveillance
- 10-3. You have used an informant for a drug buy and you want the evidence to be admissible. With whom should you consult about the adequacy of the surveillance?
1. Prosecutor
 2. Judge advocate
 3. Defense counselor
 4. Local authorities
- 10-4. When a drug violator is being apprehended, the suspect should be read his or her rights as soon as possible.
1. True
 2. False
- 10-5. After apprehending a suspect of narcotics abuse, you must seize all drugs in his or her possession even if the drugs had been prescribed by medical authorities.
1. True
 2. False
- 10-6. When a suspect has a prescription for a drug in his or her possession, you do not need verification from a medical officer.
1. True
 2. False
- 10-7. When you are searching for drugs, the variety of hiding places for narcotics is limited only by the ingenuity of the violator.
1. True
 2. False
- 10-8. When referring to substances suspected of being drugs, you must refer to the evidence by its physical appearance.
1. True
 2. False

- 10-9. As an evidence custodian, you will be asked to dispose of drugs that are no longer needed for evidence. What is the proper way to destroy them?
1. Flush the drugs down a toilet and document the date
 2. Turn the drugs over to customs and have them fly the drugs to open sea and dump them
 3. Turn the drugs over to NCIS for disposition
 4. Destroy narcotics by fire and have the act witnessed by a disinterested person
- 10-10. From what source does the Navy get most of its small arms?
1. The Army
 2. The Marine Corps
 3. The manufacturers
 4. The Springfield Armory
- 10-11. Where are small arms maintenance requirements found?
1. TMs
 2. MRCs
 3. Army FMs
 4. Marine Corps FMs
- 10-12. What is the Navy equivalent of the Army's M1911A1?
1. Mk 1911 Mod 1
 2. Mark 1911 Model 1
 3. Model 1911 Modification 1
 4. Model 1911 Alteration 1
- 10-13. What is the bore diameter of the 12-gauge shotgun?
1. .120 in.
 2. .125 in.
 3. .410 in.
 4. .729 in.
- 10-14. What function in the small arms cycle of operation keeps the bolt closed after firing to prevent loss of gas pressure?
1. Feeding
 2. Locking
 3. Ejection
 4. Extraction
- 10-15. What two small arms components work together to remove a spent cartridge case from the chamber and expel it from the weapon?
1. Extractor and ejector
 2. Sear and case extractor
 3. Case remover and ejector
 4. Case remover and extractor
- 10-16. What type of small arms weapon requires the trigger to be pulled each time a round is to be fired?
1. Automatic
 2. Gas-operated
 3. Semiautomatic
 4. Blowback-operated
- 10-17. What type of small arms operation allows a weapon to keep firing as long as the trigger is kept pulled?
1. Automatic
 2. Gas-operated
 3. Recoil-operated
 4. Blowback-operated
- 10-18. What type of small arms weapon uses the force of the burning propellant to operate the bolt and feeder mechanisms?
1. Automatic
 2. Gas-operated
 3. Semiautomatic
 4. Blowback-operated

- 10-19. In what type of small arms operation are the barrel and bolt locked together for a short time as they travel rearward after firing?
1. Automatic
 2. Gas-operated
 3. Recoil-operated
 4. Blowback-operated
- 10-20. In what type of small arms operation is the weight of the breechbolt an important factor?
1. Automatic
 2. Gas-operated
 3. Recoil-operated
 4. Blowback-operated
- 10-21. What term describes the greatest distance a weapon can be expected to fire accurately?
1. Accurate range
 2. Effective distance
 3. Maximum accurate range
 4. Maximum effective range
- 10-22. What term describes the number of rounds per minute that a weapon can fire in full automatic operation?
1. Sustained rate of fire
 2. Maximum rate of fire
 3. Cyclic rate of fire
 4. Times rate of fire
- 10-23. What type of operation does the .45-caliber pistol use?
1. Automatic
 2. Autoloading
 3. Gas operation
 4. Recoil operation
- 10-24. The magazine of an M1911A1 pistol can hold a total of how many rounds?
1. Five
 2. Six
 3. Seven
 4. Nine
- 10-25. Which of the following actions should you take before performing any work on a weapon?
1. Dry-fire the weapon
 2. Make sure the weapon is clear of ammunition
 3. Get permission from the work center supervisor
 4. Inform the work center supervisor
- 10-26. What is the first step in field-stripping an M1911A1 pistol?
1. Removing the slide stop
 2. Releasing the operating spring tension
 3. Removing the firing pin
 4. Removing the barrel bushing
- 10-27. The pins of an M1911A1 pistol should be installed from left to right only.
1. True
 2. False
- 10-28. Which of the following is a positive safety on the M1911A1 pistol?
1. Safety lock
 2. Grip safety
 3. Disconnect safety
 4. Half-cocked safety
- 10-29. How does the grip safety prevent firing of the M1911A1 pistol?
1. By locking the sear in place
 2. By locking the hammer in place
 3. By preventing movement of the sear
 4. By preventing movement of the trigger

- 10-30. On an M1911A1 pistol, when does the disconnecter function to prevent firing?
1. When the hammer is not fully cocked
 2. When the safety lock is engaged
 3. When the slide is fully forward
 4. When the slide is not fully forward
- 10-31. What Navy personnel are often issued the .38-caliber pistol?
1. Flight personnel only
 2. Surface ship security personnel only
 3. Flight and ashore security personnel
 4. Security personnel ashore and aboard submarines
- 10-32. What does the term "double-action firing" describe when applied to the standard issue .38-caliber pistol?
1. That the hammer must be pulled back to the full-cocked position for each round fired
 2. That the cylinder is automatically rotated when the hammer is cocked
 3. That the hammer is automatically recocked after each firing using recoil forces
 4. That the cylinder is rotated and the hammer raised and released for firing, all by pulling the trigger
- 10-33. What safety feature on the .38-caliber pistol prevents accidental firing of the uncocked pistol if it is dropped?
1. The hammer block
 2. The disconnecter
 3. The rebound slide
 4. The firing interrupt
- 10-34. When disassembling the .38-caliber pistol for cleaning, what must be done to remove the cylinder? (Refer to figure 8-7, view B)
1. Remove sideplate screws No. 1 and 2 then hold the thumb piece forward while cocking the weapon
 2. Unscrew the ejector plunger
 3. Hold the thumb piece forward while cocking the weapon only
 4. Remove sideplate screw No. 1 only
- 10-35. What type of operation does the M-14 rifle use?
1. Gas
 2. Recoil
 3. Radial
 4. Blowback
- 10-36. Where is the safety located on the M-14 rifle?
1. On the left rear side of the receiver
 2. Forward of the trigger guard
 3. On the right rear side of the receiver
 4. In the center of the rear hand grip
- 10-37. What device activates the bolt lock of an M-14 rifle to hold the bolt in the rearward position after the last round is fired?
1. The connector
 2. The disconnecter
 3. The magazine latch
 4. The magazine follower

- 10-38. When is an M-14 rifle considered clear?
1. After the last round is fired, the bolt is open, and the safety is set
 2. When the safety is set, the bolt is open, and there is no round in the chamber
 3. When the magazine is removed, the bolt is open, and there is no round in the chamber
 4. When the bolt is open, the magazine is out, the safety is set, and there is no round in the chamber
- 10-39. What is the A1 upgrade to the M-16 rifle?
1. Increased the bolt tolerances
 2. Added the charging handle
 3. Made the weapon capable of full automatic fire
 4. Added the forward assist mechanism
- 10-40. Why is it preferable to load an M-16A1 rifle with the bolt open?
1. It reduces the likelihood of first round stoppages
 2. It is safer
 3. It reduces the possibility of accidentally discharging the weapon
 4. It allows the operator to inspect the chamber prior to loading
- 10-41. What must be done to chamber a round in an M-16A1 rifle if the magazine is inserted with the bolt closed?
1. The charging handle must be depressed
 2. The charging handle must be pulled fully to the rear and then eased back to the forward position
 3. The charging handle must be pulled fully to the rear and released
 4. The charging handle must be pulled to the rear and locked in position until the first round is fired
- 10-42. When should the operator of an M-16A1 rifle strike the forward assist?
1. When inserting a magazine to ensure it is properly latched
 2. When chambering the first round
 3. When the bolt fails to go fully forward
 4. To remove a stuck magazine
- 10-43. How many rounds of ammunition does the tubular magazine of the M870 shotgun hold when fully loaded?
1. Five
 2. Six
 3. Three
 4. Four
- 10-44. Where is the safety located on the M870 shotgun?
1. In the center of the rear hand grip
 2. On top of the receiver
 3. In the front of the trigger guard
 4. In the rear of the trigger guard

- 10-45. In what direction must the safety be pushed to be placed in the SAFE position?
1. Left to right
 2. Right to left
 3. Front to back
 4. Back to front
- 10-46. What must the operator do to pump the fore-end to the rear if the M870 shotgun is cocked?
1. Set the safety
 2. Release the safety
 3. Press the action bar lock
 4. Release the action bar lock
- 10-47. What is the function of the action bar lock on an M870 shotgun?
1. It disconnects the trigger and sear assembly while the bolt is open and aligns each round of ammunition for proper seating
 2. It aligns each round of ammunition for proper seating and locks the action closed
 3. It locks the action closed and disconnects the trigger and sear assembly while the bolt is open
 4. It aligns each round of ammunition for proper seating and prevents double feeding
- 10-48. At what point in movement of the fore-end of an M870 shotgun is a round of ammunition released from the tubular magazine to be fed into the chamber?
1. At the beginning of forward movement
 2. At the end of rearward movement
 3. When the action bar lock is released after firing
 4. As the spent shell casing is ejected
- 10-49. Which of the following actions must be taken to remove the barrel of an M870 shotgun?
1. Unscrew the barrel retaining nut
 2. Drive out the barrel retaining pins
 3. Rotate the barrel lock 90 degrees
 4. Remove the magazine cap
- 10-50. How is the breech bolt removed from an M870 shotgun?
1. By driving out the breech bolt retaining pin
 2. By removing the fore-end unit from the receiver
 3. By removing the bolt retainer and then pulling the bolt through the ejection port
 4. By removing the trigger plate assembly and pulling the bolt through the bottom of the receiver
- 10-51. Where is the safety switch located on an M500 shotgun?
1. On top of the receiver
 2. To the rear of the trigger guard
 3. To the front of the trigger guard
 4. On the bottom of the receiver
- 10-52. What type of operation does the M-60 machine gun use?
1. Gas
 2. Blowback
 3. Recoil
 4. Semiautomatic
- 10-53. What is the maximum effective range of the M-60 machine gun?
1. 1,100 yd
 2. 1,200 yd
 3. 1,000 m
 4. 1,200 m

- 10-54. How many clicks of the windage knob on an M-60 machine gun would be necessary to correct for a 5-yard discrepancy when firing at a target 1,000 yards away?
1. 5
 2. 8
 3. 10
 4. 20
- 10-55. The M-60 machine gun is designed to function semiautomatically as long as ammunition is fed into the gun and the trigger is held to the rear.
1. True
 2. False
- 10-56. On the M-60 machine gun, what part drives the operating rod and bolt forward?
1. Trigger
 2. Feed tray
 3. Sear notch
 4. Operating rod spring
- 10-57. What action causes the bolt of an M-60 machine gun to lock into the barrel?
1. The barrel is cammed to cause the bolt to turn one-quarter turn counterclockwise, locking the lugs into slots in the barrel
 2. The operating rod yoke rides against the bolt camming slot to turn the bolt one-quarter turn clockwise
 3. Two locking levers are cammed out and over the two bolt lugs as it closes the breech
- 10-58. What causes the firing pin to strike the primer of a chambered round in an M-60 machine gun?
1. The hammer striking the rear of the firing pin
 2. The firing pin is a machined knob on the face of the bolt that strikes the primer as the bolt closes
 3. The firing pin is carried forward into the primer by the operating rod yoke
 4. The hammer strikes the rear of the bolt, which transmits force to the firing pin and carries it into the primer
- 10-59. What action of the M-60 machine gun causes the firing pin spring to fully compress?
1. The operating rod yoke moving to the rear against the firing pin spool
 2. The rearward movement of the link ejection port
 3. The forward movement of the feed plate groove
 4. The ejector rod spring moving forward against the firing pin
- 10-60. Which of the following actions cocks the M79 grenade launcher?
1. Retracting the bolt
 2. Pulling the trigger guard
 3. Opening the grenade launcher
 4. Retracting the charging lever
- 10-61. What is accomplished when the barrel locking latch of the M79 grenade launcher is moved all the way to the right?
1. The safety is engaged
 2. The safety is disengaged
 3. The barrel is locked in the firing position
 4. The direct fire sight is visible for use

- 10-62. What is considered battle sight range for the M79 grenade launcher?
1. 50 - 80 yd
 2. 165 - 265 m
 3. 50 - 80 ft
 4. 165 - 265 ft
- 10-63. Failure to accomplish what action causes most accidents involving weapons?
1. Set the safety
 2. Remove the magazine
 3. Inspect the chamber
 4. Dry fire the weapon
- 10-64. What must you assume about a weapon when the breech is closed and/or a magazine is installed?
1. The weapon might be loaded
 2. The weapon is loaded
 3. The weapon has been cleared and is ready to be restowed
 4. The weapon is safe
- 10-65. A weapon should only be pointed at what type of targets?
1. Those that you may have to shoot or frighten
 2. Those you are ready to destroy
 3. Those that pose a possible danger to you
- 10-66. What should you do if you experience a misfire while firing an M-14 rifle?
1. Immediately eject the round and keep firing
 2. Recock the weapon and try to fire again
 3. Strike the forward assist
 4. Wait 10 seconds and eject the round
- 10-67. When firing small arms, what might a light recoil indicate?
1. A misfire
 2. An obstructed bore
 3. The bullet disintegrated
 4. The last round has been fired
- 10-68. Normally, what source should be used to determine the preventive maintenance procedures on Navy small arms?
1. TMs
 2. FMs
 3. MRCs
 4. OPs
- 10-69. What instruction governs the security of Navy small arms?
1. OPNAVINST 8010.12
 2. OPNAVINST 5530.13
 3. NAVSEAINST 5530.12
 4. SECNAVINST 3055.13
- 10-70. Because small arms are considered equipment, what procedure should be used when small arms are issued?
1. The issue must be witnessed by a third person
 2. The receiving person must sign for the weapon
 3. Only E-4 and above may be issued weapons
 4. A commissioned officer must approve the issue
- 10-71. What should you verify before issuing a weapon to any individual?
1. How long the person will have the weapon
 2. If the weapon is to leave the ship
 3. What the weapon will be used for
 4. If the person has been authorized to draw a weapon

10-72. Which of the following is required of a person on duty in an arms storage room?

1. Armed at all times
2. An expert on explosion
3. A petty officer or above
4. Within eyesight of the weapons

10-73. There are a total of how many important elements of marksmanship?

1. One
2. Two
3. Three
4. Four

10-74. Marksmanship training is divided into a total of how many phases?

1. One
2. Two
3. Three
4. Four

10-75. What is the purpose of preparatory marksmanship?

1. To sight in a weapon
2. To control trigger pull
3. To establish safety procedures
4. To establish correct shooting habits

ASSIGNMENT 11

Textbook Assignment: "Small Arms (continued)," "Crowd Control," and "Physical Security," chapters 8, 9, and 10, pages 8-28 through 10-4.

- 11-1. The proper grip for quick fire is determined by increasing the grip pressure until the hand starts to shake and then releasing the pressure until which of the following actions occurs?
1. The pistol is in balance
 2. The pistol feels natural
 3. The hand stops shaking
- 11-2. You are firing the .38-caliber pistol and there is 1/10-inch error in the sight alignment. If your target is 25 meters away, by how many inches will you miss the point of aim?
1. 15
 2. 20
 3. 30
 4. 40
- 11-3. Perfect sight alignment is virtually impossible, since the front sight is continually moving.
1. True
 2. False
- 11-4. With regards to marksmanship, the cause of most target misses is improper
1. grip
 2. trigger control
 3. sight alignment
 4. aiming techniques
- 11-5. Which of the following conditions must exist before military intervention in a civil disturbance is ordered?
1. Local authorities are incapable of restoring order
 2. Local authorities have made no attempt to restore order
 3. The extent of the disturbance makes it obvious that local authorities will not be able to restore order
 4. Each of the above
- 11-6. Who is responsible for coordinating all Federal Government activities relating to civil disturbances?
1. The Attorney General
 2. The Secretary of the Army
 3. The Secretary of the Navy
 4. The Secretary of Defense
- 11-7. In the event of a civil disturbance, who has been designated Executive Agent for the Department of Defense in all matters pertaining to the planning of military resources?
1. The Attorney General
 2. The Secretary of the Army
 3. The Secretary of the Navy
 4. The Secretary of Defense
- 11-8. Intervention falls into a total of how many categories?
1. One
 2. Two
 3. Three
 4. Four

- 11-9. What term identifies a temporary government function organized to restore order within a country or locality?
1. Martial law
 2. Military aid
 3. Martial decree
 4. Military government
- 11-10. What term identifies a mass of people whose members lose their concern for laws and authority and follow their leaders into unlawful and disruptive acts?
1. Uncontrolled crowd
 2. Unruly crowd
 3. Casual crowd
 4. Mob
- 11-11. Who is influenced by psychological behavior factors during civil disturbances?
1. Officer in charge of the control force
 2. Chief Petty Officer in charge of the control force
 3. Members of the crowd
 4. All of the above
- 11-12. What would cause a control force member to commit acts that he would normally suppress?
1. A high degree of self-discipline
 2. Feeling of anonymity
 3. Being corrected immediately for an unauthorized act
 4. Taking a corrective action based on what, rather than who, is involved
- 11-13. Which of the following conditions can help stem or prevent impersonality between members of a crowd control force?
1. Racial and ethnic balance
 2. An understanding of the people involved in the disturbance
 3. Both 1 and 2 above
 4. Equal weapons distribution
- 11-14. Which of the following characteristics will help a person resist the tendency to conform with group behavior?
1. Quick temper
 2. Indecisiveness
 3. Strong convictions
 4. Urge to follow others
- 11-15. Which of the following characteristics replaces the normal controls within members of a crowd when emotional contagion prevails?
1. Inhibition
 2. Raw emotion
 3. Individual restraint
 4. Increased consciousness
- 11-16. A crowd usually considers its actions to be
1. against the law
 2. morally justified
 3. morally unjustified
 4. equally right and wrong
- 11-17. Which of the following crowd behavior factors is considered to be an external control?
1. Police
 2. Weather
 3. Local government
 4. Each of the above
- 11-18. Why do mobs often direct verbal abuse toward disturbance control forces?
1. To cause them to take actions that later may be exploited as acts of brutality
 2. To emphasize their right to free speech
 3. To help express their strong feelings
 4. To impress the news media

- 11-19. Why would a mob place women, children, and elderly people in their front ranks?
1. To protect themselves against weapons fire
 2. To play on the sympathy of the control force
 3. To gain sympathy of the public
 4. To agitate the control force

- 11-25. The objective of the control force in a civil disturbance, regardless of the situation, is to gain immediate and full control.
1. True
 2. False

- 11-26. The control force should avoid using provocative measures to impose a degree of control beyond its capabilities.

1. True
2. False

- 11-27. A control force must reduce the intensity of a disturbance to its lowest level, given all the variables of a situation.

1. True
2. False

- 11-28. Which of the following factors may influence or necessitate the decision to seek an interim objective?

1. Time of day
2. Sympathies of the public
3. Magnitude of the confrontation
4. Each of the above

- 11-29. What is the primary factor that contributes to the reduction of intensities between the control force and the dissident element?

1. Strategy
2. Communications
3. Readiness of police
4. Sympathies of the public

- 11-30. Of the following principles of civil disturbance control, which one is applicable in full measure to each disturbance situation?

1. Minimum force
2. Operational unity
3. Professional imagery
4. Coordinated preparation

FOR QUESTIONS 11-20 THROUGH 11-23, SELECT THE TYPE OF SITUATION FROM COLUMN B THAT MATCHES THE DESCRIPTION IN COLUMN A.

<u>A. DESCRIPTIONS</u>	<u>B. SITUATIONS</u>
11-20. Involves extremely violent, often radical tactics	1. Mass demonstration
11-21. Involves many small groups of dissidents acting irrationally out of frustration and bitterness	2. Terrorism
11-22. Involves fanatically dedicated participants on whom the threat of arrest has little or no effect	3. Idealistic protest
11-23. Involves thousands of people protesting within their rights	4. Dispersed riot

11-24. Law and order is a relative term that can generally be equated to a state of normalcy in the community.

1. True
2. False

- 11-31. Control force personnel must at all times use only the minimum force required to accomplish the mission.
1. True
 2. False
- 11-32. Which of the following policy statements regarding the use of deadly force is true?
1. Warning shots should be fired when necessary
 2. Control force personnel may carry unloaded firearms
 3. The authority to use deadly force should not be delegated
 4. The use of deadly force should be preceded by a clear warning
- 11-33. Which of the following actions is the main objective for isolating an area during a disturbance?
1. To keep out the news media
 2. To protect the people who are involved in the disturbance
 3. To prevent the disorder from spreading
 4. To protect the property in the isolated area
- 11-34. Which of the following factors is NOT a variable of a crowd or mob?
1. Public opinion
 2. Mission of the mob
 3. Crowd and mob mood
 4. Weather and time of day
- 11-35. What characteristic does a crowd possess that is not present in a mob?
1. Mixed ethnic background
 2. Similar ethnic background
 3. A collective sense of fear
 4. An inclination toward violence
- 11-36. What is the attitude of mob members toward the law?
1. They have an extreme fear of the law
 2. They lose all sense of fear of the law
 3. They generally respect the law
 4. They hate the law
- 11-37. Of the following crowd control techniques, which one includes an attempt to facilitate the protestor's opportunity to peacefully demonstrate?
1. Diversion
 2. Cooperation
 3. Proclamation
 4. Channelization
- 11-38. When the military is charged with control of a civil disturbance, who will issue the Presidential proclamation to the community?
1. Mayor
 2. State governor
 3. Chief of police
 4. CO's representative at the scene
- 11-39. What crowd control technique would employ the marching of a well-equipped and highly disciplined control force into view of an assembled crowd?
1. Show of force
 2. Channelization
 3. Use of barriers
 4. Apprehension of crowd members
- 11-40. The actual apprehension and processing of civilian law violators should be done by what authority?
1. Security department on base
 2. Civil police officers
 3. Master-at-Arms
 4. Shore patrol

- 11-41. When used against a mob during cold weather, which of the following is a highly effective deterrent?
1. CO₂
 2. Foam
 3. Water
 4. Tear gas
- 11-42. What device does the control force normally use to disperse large crowds without ever actually coming into contact with the rioters?
1. Bayonets
 2. Leaflets
 3. Riot control agents
 4. High pressure water
- 11-43. Which of the following tactics should NOT be used against a mob?
1. Dare
 2. Bluff
 3. Threat
 4. Each of the above
- 11-44. When the front of a mob cannot retreat because of pressure from behind, the mob should be attacked from what direction?
1. The rear
 2. The front
 3. The left flank
 4. The right flank
- 11-45. Using blank cartridges is highly recommended when combating mob violence.
1. True
 2. False
- 11-46. When tear gas grenades are used to disperse a mob, they should be projected to the windward side of the rioters.
1. True
 2. False

- 11-47. Normally, a mob has the advantage during hand-to-hand combat because of its superior numbers.
1. True
 2. False
- 11-48. If you are wearing a helmet, face shield and flak jacket, this would offer sufficient protection to confront a mob.
1. True
 2. False
- 11-49. What formations are most frequently used to disperse mobs?
1. Wedge, line, and echelon
 2. Wedge, arch, and triangle
 3. Circle, loop, and diamond
 4. Square, arrow, and straight

IN ANSWERING QUESTIONS 11-50 THROUGH 11-52, SELECT THE TYPE OF FORMATION FROM COLUMN B THAT MATCHES THE OFFENSIVE/DEFENSIVE TACTIC LISTED IN COLUMN A.

A. OFFENSIVE/ DEFENSIVE TACTICS	B. TYPE OF FORMATION
11-50. Used to turn groups in either open or built-up areas, and to move personnel away from buildings	1. Wedge 2. Echelon 3. Line
11-51. Used to push or drive crowds straight back or across an open area	
11-52. An offensive formation used to penetrate and split crowds	

11-53. Which of the following riot control weapons is most effective in a crowd control operation and, if lost, does not create a serious threat?

1. Baton
2. Shotgun
3. Tear gas
4. Bayonets

11-54. As a Master-at-Arms you may be called on to help quell a civil disturbance and you may be subjected to insults and abusive name calling in the process. How should you react?

1. Conduct an arrest
2. Return the insults
3. Fire a warning shot
4. Learn to ignore them

11-55. With regard to stress and being mentally prepared for disturbance operations, the MA should expect members of a crowd to exhibit which of the following unusual actions?

1. Tearing off clothing
2. Screaming and rushing
3. Deliberate self-injury
4. Each of the above

11-56. How should you familiarize your control force with the stress of mob confrontation?

1. Conduct a seminar dealing with various riots
2. Show movies of riots, pointing out various methods of control
3. Conduct an actual riot using some of your force as the mob
4. Show movies of people who are under stress and exhibit abnormal behavior patterns

11-57. Control forces on duty for extended periods of time tend to suffer from which of the following conditions?

1. Strain
2. Anxiety
3. Fatigue
4. All of the above

11-58. A control force under the cumulative effect of psychological factors may respond excessively. Which of the following elements may cause a control force to act excessively?

1. Rumor
2. Lack of knowledge
3. The fatigue factor
4. All of the above

- | |
|-----------------------|
| A. Security officer |
| B. Activity |
| C. POA&M |
| D. ASF |
| E. Pilferage |
| F. Security manager |
| G. Property |
| H. Counterterrorism |
| I. Installation |
| J. Exception |
| K. Facility |
| L. Commanding officer |
| M. Waiver |

Figure 11-A

IN ANSWERING QUESTIONS 11-59 THROUGH 11-70, SELECT THE PHYSICAL SECURITY TERM FROM FIGURE 11-A THAT MATCHES THE DESCRIPTION GIVEN AS THE QUESTION. RESPONSES MAY BE USED MORE THAN ONCE.

11-59. A permanent deviation from a specific security requirement.

1. C
2. E
3. G
4. J

11-60. Any unit of the naval shore establishment.

1. B
2. G
3. I
4. K

11-61. An armed force derived from host and tenant commands.

1. C
2. D
3. G
4. I

11-62. Petty larceny.

1. C
2. E
3. H
4. J

11-63. Corrective courses of action and expected dates of completion.

1. C
2. D
3. E
4. J

11-64. Principal advisor in matters pertaining to the security of classified information.

1. A
2. D
3. F
4. L

11-65. Offensive measures taken to prevent terrorism.

1. B
2. G
3. H
4. J

11-66. All assets.

1. B
2. G
3. I
4. K

11-67. A real property entity.

1. C
2. E
3. G
4. K

11-68. Responsible for the development of a command's physical security program.

1. A
2. D
3. F
4. L

11-69. A written temporary relief.

1. C
2. E
3. J
4. M

11-70. A grouping of facilities.

1. B
2. G
3. I
4. K

11-71. Who is ultimately responsible for all security?

1. Security officer
2. Security manager
3. Chief of police
4. Commanding officer

11-72. What instruction covers in detail how the security officer should perform his duties?

1. OPNAVINST 5580.1
2. OPNAVINST 5510.1
3. OPNAVINST 5530.13
4. OPNAVINST 5530.14

11-73. The duties of a security department fall into a total of how many basic categories?

1. Seven
2. Five
3. Three
4. Nine

11-74. Regardless of its size or mission, each activity is required to have which of the following security committees?

1. LPS
2. PSRC
3. Both 1 and 2 above
4. PSRB

11-75. Who should act as the chairperson of the physical security review committee?

1. Security officer
2. Executive officer
3. Senior NCIS agent
4. Commanding officer

ASSIGNMENT 12

Textbook Assignment: "Physical Security (continued)," chapter 10, pages 10-4 through 10-20.

- 12-1. What security committee is designed to address security-related matters on an installation-wide perspective?
1. LPS
 2. LEPS
 3. PSRC
 4. PSRB
- 12-2. Personnel selected as the command key control officer ideally should have a clearance equal to the highest level of classified material held at the command.
1. True
 2. False
- 12-3. Which of the following personnel should NOT have access to a central key room?
1. Locksmith
 2. Key custodian
 3. Commanding officer
 4. Public works officer
- 12-4. The lack of free play in a car ball end seal may indicate tampering. Approximately how much free play, in inches, should there be?
1. 1/16
 2. 1/8
 3. 1/4
 4. 1/2
- 12-5. How often should all unused seals be inventoried?
1. Monthly
 2. Quarterly
 3. Semiannually
 4. Annually
- 12-6. Which of the following instructions outlines policy on quarterdeck inspections?
1. OPNAVINST 5580.1
 2. OPNAVINST 5530.14
 3. OPNAVINST 3120.32
 4. OPNAVINST 2910.2
- 12-7. Which of the following personnel would be exempt from an administrative inspection of vehicles while on official duty?
1. NCIS agent
 2. Security officer
 3. Base commanding officer
 4. Chief of Naval Training
- 12-8. Perimeter and area protective controls are the first steps in providing protection against certain security hazards.
1. True
 2. False
- 12-9. All security barriers are broken down into what two types?
1. Natural and structural
 2. Buildings and mountains
 3. Fences and waterways
 4. Perimeters and buildings
- 12-10. Which of the following security methods should be used to secure relatively small restricted areas within an installation?
1. Limited
 2. Enclaving
 3. Exclusion
 4. Controlled

- A. Level one
- B. Level two
- C. Level three
- D. Nonrestricted

Figure 12-A

IN ANSWERING QUESTIONS 12-11 THROUGH 12-21, SELECT THE SECURITY AREA FROM FIGURE 12-A THAT MATCHES THE DESCRIPTION GIVEN AS THE QUESTION. RESPONSES MAY BE USED MORE THAN ONCE.

12-11. An asset lost or stolen from this area would cause serious damage.

- 1. A
- 2. B
- 3. C
- 4. D

12-12. The most secure type of restricted area.

- 1. A
- 2. B
- 3. C
- 4. D

12-13. Access to this area constitutes access to the security interest.

- 1. A
- 2. B
- 3. C
- 4. D

12-14. Never inside a level three area.

- 1. A
- 2. B
- 3. C
- 4. D

12-15. An asset stolen from this area would cause grave damage.

- 1. A
- 2. B
- 3. C
- 4. D

12-16. Unescorted movement in this area could permit access to the security interest.

- 1. A
- 2. B
- 3. C
- 4. D

12-17. This area is the least secure type of restricted area.

- 1. A
- 2. B
- 3. C
- 4. D

12-18. Access to this area is minimally controlled or uncontrolled.

- 1. A
- 2. B
- 3. C
- 4. D

12-19. This type of area should not be located inside restricted areas.

- 1. A
- 2. B
- 3. C
- 4. D

12-20. This area may serve as a buffer zone for a level two area.

- 1. A
- 2. B
- 3. C
- 4. D

12-21. Uncontrolled movement may or may not permit access to a security interest.

- 1. A
- 2. B
- 3. C
- 4. D

- 12-22. Which of the following security areas is required to have the perimeter fence posted at no less than 100 feet intervals along the perimeter?
1. Level one
 2. Level two
 3. Level three
 4. Each of the above
- 12-23. Which of the following security areas requires that visitors be logged in and out during normal duty hours?
1. Level one
 2. Level two
 3. Level three
 4. Each of the above
- 12-24. During normal duty hours, the use of an access list and entry and departure log is suggested but not required for what security area(s)?
1. Level one
 2. Level two
 3. Both 1 and 2 above
 4. Level three
- 12-25. What appendix of OPNAVINST 5530.14 lists facilities and assets that are critical and essential to the overall mission of the Navy?
1. VI
 2. VII
 3. VIII
 4. IX
- 12-26. At a minimum, how often should administrative vehicle and personnel inspections operations be conducted?
1. Daily
 2. Weekly
 3. Biweekly
 4. Monthly
- 12-27. Which of the following agencies has/have the authority to control access to certain limited waterway areas under its jurisdiction when security dictates?
1. USCG
 2. USACE
 3. Both 1 and 2 above
 4. NCIS
- 12-28. In which of the following limited waterway areas may enforcement be delegated to the Navy command?
1. Restricted waterfront
 2. Restricted area
 3. Security zone
 4. Safety zone
- 12-29. The signs posted at points of ingress to restricted areas should be approximately what size?
1. 2 ft x 2 ft
 2. 2 ft x 3 ft
 3. 3 ft x 3 ft
 4. 4 ft x 4 ft
- 12-30. The signs posted on perimeter barriers of restricted areas should be approximately what size?
1. 12 in. x 18 in.
 2. 12 in. x 24 in.
 3. 2 ft x 2 ft
 4. 3 ft x 3 ft
- 12-31. The signs posted on perimeter barriers of nonrestricted areas should be approximately what size?
1. 11 in. x 12 in.
 2. 12 in. x 24 in.
 3. 2 ft x 2 ft
 4. 3 ft x 3 ft

- 12-32. The interval between signs posted along restricted and nonrestricted area perimeters should not exceed how many feet?
1. 50
 2. 100
 3. 150
 4. 200
- 12-33. During daylight conditions, signs should be legible from a distance of at least how many feet?
1. 25
 2. 50
 3. 100
 4. 150
- 12-34. The lettering in area perimeter signs should be black in color except for the word "WARNING," which should be red in color.
1. True
 2. False
- 12-35. A light source that points toward likely avenues of approach and provides relative darkness for security personnel is called what type of lighting?
1. Shadow zone
 2. Overlapping
 3. Spot projection
 4. Glare projection
- 12-36. The two primary methods of continuous lighting are glare projection and controlled.
1. True
 2. False
- 12-37. What type of lighting is used to limit the width of a lighted strip outside a perimeter?
1. Shadow
 2. Moveable
 3. Controlled
 4. Glare projection
- 12-38. What type of lighting is turned on automatically when activity is detected by an intrusion system?
1. Controlled
 2. Moveable
 3. Standby
 4. Emergency
- 12-39. What type of lighting is normally used to supplement continuous lighting?
1. Standby
 2. Moveable
 3. Emergency
 4. Controlled
- 12-40. Who decides what additional areas, if any, need illuminating at a command?
1. Commanding officer
 2. Security officer
 3. Public works officer
 4. Chief of police
- 12-41. How often should protective lighting be checked by security force personnel?
1. Daily
 2. Weekly
 3. Biweekly
 4. Monthly
- 12-42. How often should an emergency power system be tested?
1. Daily
 2. Weekly
 3. Monthly
 4. Yearly
- 12-43. The test results of an emergency power system should be recorded for how many years?
1. 5
 2. 2
 3. 3
 4. 4

- 12-44. At least how often should an immediate superior in command conduct a physical security inspection?
1. Every year
 2. Every 2 years
 3. Every 3 years
 4. Every 5 years
- 12-45. The purpose of a physical security survey is to evaluate the adequacy of a command's security program.
1. True
 2. False
- 12-46. A physical security survey should be conducted during which of the following times?
1. Normal working hours
 2. Non-duty hours
 3. Hours of darkness
 4. All of the above
- 12-47. Physical security surveys are management tools that are normally sent up the chain of command.
1. True
 2. False
- 12-48. A total of how many types of physical security surveys are used by the Navy?
1. Five
 2. Two
 3. Three
 4. Four
- 12-49. What type of physical security survey is conducted when changes occur that could affect the physical security of an installation?
1. Initial
 2. Special
 3. Follow-up
 4. Supplemental

- | |
|---|
| <p>A. Access list</p> <p>B. Military/dependent ID card</p> <p>C. Personal recognition</p> <p>D. U.S. government ID card</p> |
|---|

Figure 12-B

IN ANSWERING QUESTIONS 12-50 THROUGH 12-57, SELECT THE ITEM FROM FIGURE 12-B THAT MATCHES THE DESCRIPTION GIVEN AS THE QUESTION. RESPONSES MAY BE USED MORE THAN ONCE.

- 12-50. The most positive method of identification.
1. A
 2. B
 3. C
 4. D
- 12-51. The least reliable means for determining access authorization.
1. A
 2. B
 3. C
 4. D
- 12-52. Optional Form 55.
1. A
 2. B
 3. C
 4. D
- 12-53. May be used to identify personnel who are authorized access to nonrestricted areas.
1. A
 2. B
 3. C
 4. D
- 12-54. Required for level three areas.
1. A
 2. B
 3. C
 4. D

- 12-55. Used in areas where the number of authorized personnel does not exceed 50.
1. A
 2. B
 3. C
 4. D
- 12-56. Should be maintained under stringent control.
1. A
 2. B
 3. C
 4. D
- 12-57. May be issued to civil service employees.
1. A
 2. B
 3. C
 4. D
-
- 12-58. When, if ever, may an assigned escort leave a visitor alone in a security area?
1. After escorting the visitor to the work area
 2. When taking a short break
 3. When the visitor goes to the bathroom
 4. Never
- 12-59. How often should installations and activities re-badge all regular employees and other personnel possessing permanent picture badges?
1. Every year
 2. Every 3 years
 3. Every 6 years
 4. Every 7 years
- 12-60. During normal daylight hours, the expiration date of a badge should be distinguishable from a distance of at least how many feet?
1. 5
 2. 2
 3. 3
 4. 7
- 12-61. All badges issued during a 6-year period ending December 1997 would normally bear a December 1997 expiration date.
1. True
 2. False
- 12-62. A contractor picture badge may be issued for what maximum period of time?
1. 6 mo
 2. 12 mo
 3. 24 mo
 4. 36 mo
- 12-63. The issuing activity should conduct an inventory of serialized badges or passes on hand at least how often?
1. Monthly
 2. Quarterly
 3. Semiannually
 4. Yearly
- 12-64. The photo on a picture badge should be of what minimum size?
1. 1 in. x 1 1/4 in.
 2. 2 in. x 1 1/2 in.
 3. 3 in. x 1 1/2 in.
 4. 3 in. x 2 in.
- 12-65. Which of the following forms is used to identify and control motor vehicles on most installations?
1. DD Form 222
 2. DD Form 321
 3. DD Form 1243
 4. DD Form 2220

- 12-66. Certain overseas activities where terrorist activity is acute may be exempt from the use of motor vehicle decals.
1. True
 2. False
- 12-67. What instruction provides guidance on the honoring of base decals issued by another activity?
1. OPNAVINST 5580.1
 2. OPNAVINST 5530.14
 3. OPNAVINST 5560.10
 4. OPNAVINST 11200.5
- 12-68. Which of the following factors should be considered in determining the feasibility and necessity of installing IDS equipment?
1. Threat
 2. Mission
 3. Criticality
 4. All of the above
- 12-69. There are a total of how many basic types of intrusion detection systems?
1. Seven
 2. Five
 3. Three
 4. Four
- 12-70. What type of intrusion detection system is prescribed for all naval activities and installations?
1. Police connection
 2. Central station
 3. Local alarm
 4. Proprietary
- 12-71. What intrusion detection system allows the intruder to know when the alarm is activated?
1. Police connection
 2. Central station
 3. Local alarm
 4. Proprietary
- 12-72. What intrusion detection system is usually connected over leased telephone company lines?
1. Police connection
 2. Central station
 3. Local alarm
 4. Proprietary
- 12-73. What intrusion detection system requires an arranged agreement prior to establishment?
1. Police connection
 2. Central station
 3. Local alarm
 4. Proprietary
- 12-74. The sensor subsystem is divided into a total of how many areas?
1. Five
 2. Two
 3. Six
 4. Four
- 12-75. What is the normal power requirement for an intrusion detection system?
1. 12 volt DC
 2. 115 volt AC
 3. 220 volt AC
 4. 440 volt AC

ASSIGNMENT 13

Textbook Assignment: "Physical Security (continued)," "Military Working Dogs," and "Patrol Procedures," chapters 10, 11, and 12, pages 10-20 through 12-22.

- 13-1. Only standard equipment intrusion detection systems, which have a normal life-span of about 10 years, should be purchased.
1. True
 2. False
- 13-2. When batteries are used as emergency power for intrusion detection systems, the batteries should last for a minimum of how many consecutive hours?
1. 6
 2. 12
 3. 24
 4. 4
- 13-3. How often should all intrusion detection systems be tested?
1. Weekly
 2. Monthly
 3. Quarterly
 4. Semiannually
- 13-4. How often should randomly selected sections of perimeter intrusion systems be tested?
1. Daily
 2. Weekly
 3. Monthly
 4. Quarterly
- 13-5. What authority is the single manager of the military working dog (MWD) program for the Department of Defense?
1. U.S. Army
 2. U.S. Air Force
 3. Chief of Naval Operations
 4. Secretary of Defense
- 13-6. Who is responsible to the security officer for managing and operating the MWD section?
1. Each handler
 2. Kernel master
 3. Shift supervisor
 4. Assistant security officer
- 13-7. An activity with 17 MWD teams assigned should have how many kennel masters?
1. One
 2. Two
 3. Three
 4. Four
- 13-8. Patrol MWD teams must maintain a proficiency level of how many points to remain certified?
1. 75
 2. 80
 3. 90
 4. 95
- 13-9. The proficiency test for an explosive/detector MWD includes at least how many trials on each odor?
1. 10
 2. 8
 3. 5
 4. 4
- 13-10. How often should the initial certifying commanding officer recertify the MWD team?
1. Annually
 2. Semiannually
 3. Quarterly
 4. Monthly

- 13-11. The normal work day for an MWD team should consist of (a) how many hours of work, and (b) how many hours of training?
1. (a) 2 (b) 2
 2. (a) 4 (b) 2
 3. (a) 2 (b) 4
 4. (a) 4 (b) 4
- 13-12. Galleys and sculleries aboard ship should not be inspected by an MWD.
1. True
 2. False
- 13-13. Who should be contacted for advice and updated guidelines regarding proper MWD search techniques?
1. Staff judge advocate
 2. Executive officer
 3. Security officer
 4. Chief Master-at-Arms
- 13-14. How should the certification of a detector MWD be documented?
1. A letter from the commanding officer in the probable cause folder
 2. A letter from the commanding officer on file at base legal
 3. A signed affidavit to search
 4. A follow-up message specifying time and date of certification
- 13-15. Where should reliable petty officers be stationed during a drug-detector dog (DDD) search?
1. At the entrance and exits of the search area
 2. 20 ft around the search team
 3. In the passageways of the deck being searched
 4. Next to any item on which the MWD alerts
- 13-16. When testimony is required from an MWD team member at a judicial proceeding, at least how many hours notice should be given?
1. 12
 2. 24
 3. 36
 4. 48
- 13-17. Who is responsible for making sure a recorder is assigned to the MWD team?
1. Handler
 2. Security officer
 3. Commanding officer
 4. Chief Master-at-Arms
- 13-18. When an MWD "responds" to a person's locker, the CMAA has probable cause to search the locker without obtaining a command authorized search or consent search from the person.
1. True
 2. False
- 13-19. Who should be notified immediately if a significant quantity of drugs is found during a search?
1. DEA
 2. NCIS
 3. TYCOM
 4. CMAA
- 13-20. Within a maximum of how many days after a search should a follow-up report be forwarded to the security officer responsible for the MWD team?
1. 7
 2. 2
 3. 10
 4. 15

- 13-21. Which of the following information should be contained in the follow-up report?
1. Assignment location
 2. Commencement time and date
 3. Handler name and rate
 4. All of the above
- 13-22. Why should any substances found after the search be tested with a field test kit and a laboratory?
1. For the MWD records
 2. For the laboratory records
 3. To verify it is an illegal drug
 4. To verify MWD team proficiency
- 13-23. A handler may let other people pet his MWD.
1. True
 2. False
- 13-24. Which of the following actions must an MWD handler take before releasing his dog?
1. Draw his weapon
 2. Ensure medical is on standby
 3. Give a verbal warning to cease all movement
 4. Request permission from the security officer
- 13-25. All MWD team personnel assigned to assist the Secret Service report directly to the special agent in charge of the operation.
1. True
 2. False
- 13-26. What is the normal attire for an MWD member who is assigned to support the Secret Service?
1. Business suit
 2. Camouflage uniform
 3. Semite dress blue
 4. Uniform of the day
- 13-27. To whom should a request for MWD support by local civilian law enforcement agencies be forwarded?
1. SECNAV
 2. SECDEF
 3. CNO
 4. CO
- 13-28. Which of the following services should NOT be provided by the MWD team?
1. Legal advice
 2. Laboratory testing
 3. Transportation of personnel
 4. All of the above
- 13-29. When the handler of an MWD is on leave, may another handler use his dog? If so, who?
1. Yes; the kennel supervisor
 2. Yes; any qualified handler
 3. Yes; security personnel
 4. No
- 13-30. Detector dogs may be used to search individual personnel.
1. True
 2. False
- 13-31. MWD teams may not be posted on quarterdecks or piers for the sole purpose of deterrence.
1. True
 2. False
- 13-32. Which of the following actions is the responsibility of the uniformed patrol?
1. Respond to calls
 2. Prevent and deter crime
 3. Respond to non-crime demands
 4. Each of the above

13-33. Generally speaking, patrol activities can be broken down into a total of how many basic categories?

1. One
2. Two
3. Three
4. Four

13-34. Who is responsible for organizing, training, and directing the police force at a command?

1. Training officer
2. Operations officer
3. Security officer
4. Patrol supervisor

13-35. Patrolmen are directly responsible to whom?

1. Security officer
2. Operations officer
3. Patrol supervisor
4. Dispatcher

- | |
|--|
| <p>A. Dispatcher</p> <p>B. Security officer</p> <p>c. Patrol supervisor</p> <p>D. Operations division officer</p> <p>E. Patrol watch commander</p> |
|--|

Figure 13-A

IN ANSWERING QUESTIONS 13-36 THROUGH 13-43, SELECT FROM FIGURE 13-A THE PERSON RESPONSIBLE FOR THE FUNCTION GIVEN AS THE QUESTION. RESPONSES MAY BE USED MORE THAN ONCE.

13-36. Monitors and directs the activities of the patrol units according to the direction of the watch supervisor.

1. A
2. C
3. D
4. E

13-37. Responsible to the security officer for the overall performance of the patrol division.

1. B
2. C
3. D
4. E

13-38. Ensures that all patrol personnel are assigned to a patrol area.

1. A
2. C
3. D
4. E

13-39. Responsible for the accuracy, grammar, and format of reports submitted.

1. B
2. C
3. D
4. E

13-40. Assigns qualified personnel to patrol duties and maintains a record of such assignments.

1. A
2. C
3. D
4. E

13-41. Ensures that the patrol duty section personnel maintain a smart and correct military appearance at all times.

1. B
2. C
3. D
4. E

13-42. Safeguards prisoners placed in detention.

1. A
2. C
3. D
4. E

A13-43. Serves as an information source for patrol units.

1. A
2. C
3. D
4. E

13-44. Which of the following is a responsibility of a patrolman?

1. Responding to radio calls and engaging in self-initiated law enforcement activities
2. Extending military courtesies and making quick decisions based on judgement
3. Patrolling the assigned area
4. Each of the above

13-45. The three types of patrol are foot patrol, motor patrol, and fixed post.

1. True
2. False

13-46. How many patrolmen are normally assigned to one patrol?

1. One
2. Two
3. Three
4. Four

13-47. In order to get assistance as a patrolman in an emergency, you must be familiar with your means of communication.

1. True
2. False

13-48. Foot patrols cover limited sectors such as high traffic areas or amusement areas.

1. True
2. False

13-49. What factor determines the short routes normally used in foot patrol?

1. Trouble spots
2. Short watches
3. Lack of vehicles
4. Lack of personnel

13-50. As a patrolman, the people who live or work in your area could be a good source of information.

1. True
2. False

13-51. Which of the following duties is/are those of a foot patrolman?

1. Being curious
2. Giving directions
3. Both 1 and 2 above
4. Assisting in civil disturbances

13-52. How should you hold your flashlight when entering dark areas?

1. In your weapon hand and directly in front of you
2. In your weapon hand and at a distance to the side of your body
3. In your non-weapon hand and directly in front of you
4. In your non-weapon hand and at a distance to the side of your body

13-53. Parking a patrol vehicle in which of the following areas would not improve public relations or effective enforcement?

1. Behind billboards
2. Among trees
3. Both 1 and 2 above
4. School zone

13-54. Which of the following characteristics should be avoided in the performance of your duty as an MA?

1. Firmness
2. Gruffness
3. Sympathy
4. Friendliness

13-55. Which of the following actions will NOT help you gain respect from others?

1. Being firm
2. Commanding it
3. Being tactful
4. Displaying cheerfulness

13-56. Which of the following would NOT constitute good actions on a patrolman's behalf?

1. Being firm without being officious
2. Being friendly and sarcastic
3. Displaying pride and interest in his duties
4. Treating all people fairly and impartially

13-57. Transportable radio sets use what type of energy supply?

1. 110 volts AC
2. Internal batteries
3. Either 1 or 2 above, depending on the type of radio
4. 20 volt

13-58. Since a two-way radio communication system consists of a base station and one or more mobile units, all sets in the net must operate on the same frequency.

1. True
2. False

13-59. A radio net must have a minimum of how many stations?

1. Five
2. Two
3. Three
4. Four

- | |
|---|
| <ol style="list-style-type: none">A. ACKNOWLEDGEB. BUSY ON ASSIGNMENTC. OUT OF SERVICED. IN SERVICEE. REPEATF. PRISONER IN CUSTODYG. RETURN TO STATIONH. WHAT IS YOUR LOCATIONI. REGISTRATION OR DRIVERS LICENSE CHECKJ. CHECK FOR WANTEDK. TRAFFIC STOPL. ROUTINE RESPONSEM. URGENT RESPONSEN. EMERGENCY RESPONSEO. OFFICER NEEDS HELP |
|---|

Figure 13-B

IN ANSWERING QUESTIONS 13-60 THROUGH 13-66. SELECT THE 10-CODE MEANING FROM FIGURE 13-B THAT MATCHES THE 10-CODE GIVEN AS THE QUESTION.

13-60. What is a 10-9?

1. A
2. B
3. E
4. G

13-61. What is a 10-7?

1. C
2. D
3. F
4. I

13-62. What is a 10-28?

1. F
2. I
3. J
4. O

13-63. What is a 10-19?

1. C
2. F
3. G
4. N

13-64. What is a 10-38?

1. A
2. E
3. K
4. L

13-65. What is a Code 1?

1. K
2. L
3. N
4. O

13-66. What is a 999?

1. F
2. H
3. N
4. O

13-67. Which, if any, of the following places would be an ideal place to pull over a vehicle to make a traffic stop?

1. On a hill
2. In a parking lot
3. At an intersection
4. None of the above

13-68. When you initiate an unknown risk traffic stop, you should park the security vehicle 10 to 12 feet to the rear of the suspect's vehicle and offset how many feet to the left?

1. 1
2. 2
3. 3
4. 4

13-69. Except for unusual circumstances, where is the best place to keep the passengers of a vehicle during a traffic stop?

1. In the vehicle
2. On the sidewalk
3. In between the suspect vehicle and security vehicle

13-70. Which, if any, of the following conditions should you be in when you conduct a traffic stop for speeding?

1. Relaxed
2. Careless
3. Unprepared
4. None of the above

13-71. When you initiate a high risk traffic stop, the security vehicle should be parked 30 to 40 feet directly behind the suspect's vehicle.

1. True
2. False

13-72. The way you approach an individual can mean the difference between a safe and effective apprehension and one that is unsafe.

1. True
2. False

13-73. What aspect of an apprehension may determine if it will be controlled or uncontrolled?

1. The booking
2. The confinement
3. The questioning
4. The first words spoken

13-74. If you are about to apprehend a suspect who has a cooperative attitude, that in itself is normally a good sign of innocence.

1. True
2. False

13-75. Should you use force on a suspect when making an apprehension? If so, what amount?

1. Yes; minimum
2. Yes; average
3. Yes; maximum
4. No

ASSIGNMENT 14

Textbook Assignment: "Patrols," "MilitARY Customs Inspections," and "Shipboard Duties," chapters 12, 13, and 14, pages 12-22 through 14-12.

- 14-1. When are you authorized to draw your weapon from your holster?
1. As a bluff
 2. When a minor offense has been committed
 3. When its use is imminent and justified
 4. Only at the end of the shift
- 14-2. Warning shots may be fired in an attempt to halt a fleeing suspect.
1. True
 2. False
- 14-3. When it becomes necessary to fire at a suspect and you kill the individual, who must prove that the killing was justified?
1. Those who witnessed the killing
 2. The immediate senior to the Master-at-Arms who did the killing
 3. The Master-at-Arms who did the killing
 4. The commanding officer of the individual who fired the weapon
- 14-4. Once a patrolman has a suspect handcuffed, he may relax just because the offender is wearing them.
1. True
 2. False
- 14-5. When you handcuff an offender who might become dangerous, where should the offender's hands be placed?
1. Behind the neck
 2. Behind the back
 3. Under the knees
 4. Under the buttocks
- 14-6. After being handcuffed, a person becomes violent. Which of the following devices should you use for additional control?
1. Belt
 2. Rope
 3. Chain
 4. Straitjacket
- 14-7. What type of law prohibits you from handcuffing prisoners to vehicle fixtures?
1. County
 2. District
 3. Federal
 4. State
- 14-8. When you use an irritant on a suspect, which of the following conditions requires that he or she be taken to medical for immediate emergency treatment?
1. Discharge of irritant at less than 2 feet into the suspect's face or eyes
 2. The suspect is not responding to normal application of the irritant formula
 3. Discharge of a large quantity of irritant in a confined area
 4. All of the above

- 14-9. What type of weapon is the police baton?
1. Defensive, nonaggressive
 2. Defensive, aggressive
 3. Offensive, nonaggressive
 4. Offensive, aggressive
- 14-10. What advantage(s) does the police baton have?
1. It is constructed without weak points
 2. It is easier to unsheathe
 3. It is more suitable for riot control
 4. All the above
- 14-11. What is the usual length of a police baton?
1. 18 in.
 2. 24 in.
 3. 26 in.
 4. 36 in.
- 14-12. When should a policeman's baton be removed from its holder?
1. When a show of force is necessary
 2. When its use is intended
 3. When the user is involved in riot control
- 14-13. Which of the following areas would NOT be considered an appropriate area to strike a suspect with a police baton?
1. Upper solar plexus
 2. Knee
 3. Leg
 4. Arm
- 14-14. When breaking a front body hold, what is accomplished by flexing your knees?
1. Your opponent will be thrown off balance
 2. Your opponent's hold will be broken
 3. Your balance will be maintained
 4. Your body's center of gravity will be raised
- 14-15. When your arms are pinned to your body, which part of an opponent's body should you strike to break a front body hold?
1. Shin
 2. Solar plexus
 3. Groin
 4. Thigh
- 14-16. Which of the following actions should you take to break a rear body hold?
1. Stomp the instep of the offender
 2. Flex your knees
 3. Strike the offender in the groin
 4. All of the above
- 14-17. Normally, the Master-at-Arms will use how many types of searches?
1. One
 2. Two
 3. Three
 4. Four
- 14-18. Why should you NEVER stand extremely close to an offender you are searching?
1. The individual might grab your gun
 2. The individual can hear your order better from a distance
 3. The individual's entire body should be within view
 4. You can counterattack better from a distance

- 14-19. When you are escorting an offender down a sidewalk, where should you have the offender walk?
1. Between you and the street
 2. Between you and the buildings
 3. In front of you
 4. In back of you
- 14-20. After handcuffing a suspect, you should check the gap between the handcuff and the suspect's wrist. How much, if any, gap should you have?
1. Approximately 1/8 in.
 2. Enough so the tip of your index finger will slide through
 3. Approximately 1 in.
 4. None
- 14-21. A male Master-at-Arms may search a female suspect's handbag, overcoat, or luggage.
1. True
 2. False
- 14-22. In what year was the Customs Inspection Regulation, DOD 5030.49-R enacted?
1. 1971
 2. 1972
 3. 1973
 4. 1974
1. NIS
 2. DOD
 3. FBI
 4. CIA
- 14-24. What authority within the DOD is assigned as the executive agent for the responsibility of customs inspection readiness?
1. Department of the Army
 2. Department of the Navy
 3. Department of the Coast Guard
 4. Department of the Air Force
- 14-25. Which of the following personnel must be granted a waiver before becoming a military customs inspector (MCI)?
1. GS-5
 2. Officer
 3. E-3
 4. E-4
- 14-26. Which of the following is NOT a task for military customs inspectors?
1. Ensuring that custom violators are reported
 2. Ensuring that all documentation they are responsible for accompanies all shipments
 3. Collecting and accepting any cash or duty payments
 4. Performing inspection as their commanders desire them to
- 14-27. When would crewmembers of a military aircraft departing from overseas and going to the CTUS normally have a baggage inspection?
1. Only in an emergency
 2. Only if there is some suspicion of drugs in their possession
 3. Just prior to takeoff
 4. Just prior to the aircraft entering CTUS

- 14-28. Prior to the inspection and examination of passengers and crewmembers, what is the first thing a military customs inspector should do?
1. Brief the individuals on their responsibilities
 2. Provide individuals with a custom declaration form
 3. Check individuals' personal property
 4. Tag items that are plant and animal products
- 14-29. What form is used for clarifying explanations of exemptions?
1. DD 1851
 2. DD 1852
 3. DD 1853
 4. DD 1854
- 14-30. Prior to inspection, what kind of remission should be set up for passengers and crewmen who have nonadmissible articles?
1. Have an hour's briefing on the do's and don'ts of contraband
 2. Have an amnesty box readily available
 3. Have them sign an additional form stating that they will never try to transport contraband again
 4. Have them placed in a rehabilitation program, if they are military
- 14-31. As an MCI, in which of the following situations may you conduct a physical examination on civilians prior to departure?
1. There is probable cause
 2. The civilian is accompanying military personnel
 3. The civilian does not object
 4. The individual works directly the government
- 14-32. As an MCI examining a passenger's baggage, you come across some contraband. Which of the following actions should you take?
1. Complete an incident report on the individual and confiscate the contraband
 2. Give the suspect his or her rights
 3. Both 1 and 2 above
 4. Call for military enforcement officials
- 14-33. All civilian personnel traveling on DOD aircraft entering CTUS as a returning resident must fill out what customs declaration form?
1. Customs Form 5029
 2. Customs Form 5129
 3. Customs Form 5229
 4. Customs Form 5430
- 14-34. When entering CTUS as a returning resident importing duty-free articles, you cannot exceed the boundaries outlined in what DOD instruction?
1. 1854
 2. 5129
 3. 5030.49-R
 4. 5440.49-R
- 14-35. All articles imported in the CTUS are subject to custom duty unless they have been exempted by-what authority?
1. Chief of transportation
 2. Chief of logistics
 3. Health inspector
 4. Tariff laws
- 14-36. Upon completion of the baggage inspection, what should the MCI do after authenticating the DD Form 1854?
1. Stamp the form and sign it
 2. Return it to the passenger
 3. Hold it until port of entry
 4. Draw a red line across the form

- 14-37. When a restricted article is found that is not declared on DD Form 1854, what action should the MCI take?
1. Reject the individual's baggage
 2. Turn all the individual's baggage over to U.S. Customs service at the point of entry
 3. Confiscate the article
 4. Draw a diagonal red line across the face of the form to call attention to U.S. Customs
- 14-38. Personnel who have completed custom processing are required to go directly to what area?
1. Embarking
 2. Sterile
 3. Departing
 4. Staging
- 14-39. Accompanied baggage in excess of immediate personal needs is normally inspected by an MCI how many days prior to unit departure?
1. 1 to 2
 2. 3 to 4
 3. 5 to 6
 4. 7 to 8
- 14-40. What inspection is normally conducted under technical supervision of U.S. Customs and U.S. Department of Agriculture advisors?
1. Local
 2. U.S. Federal
 3. Preclearance
 4. Predeparture
- 14-41. After completing a thorough inspection on a crate scheduled for CTUS, what MCI (label) DD Form should you immediately affix to the container?
1. 1529
 2. 1253
 3. 1854
 4. 5030
- 14-42. What customs declaration form may be used in an enclosed letter or parcel?
1. PS Form 2976-A
 2. PS Form 2966-A
 3. DD Form 1252
 4. DD Form 1252-1
- 14-43. Military departments that operate ships and aircraft coming from overseas must comply with which of the following instructions?
1. DOD 1854
 2. DOD 5030.49-R
 3. DOD 5129
 4. DOD 5440.49-R
- 14-44. Some ships entering CTUS are exempt from a military customs inspection.
1. True
 2. False
- 14-45. The reason for a customs inspection on board ship prior to its entry into the CTUS from overseas is to preclude the introduction of contraband.
1. True
 2. False
- 14-46. At least how many MCIs are usually maintained onboard a ship?
1. One
 2. Two
 3. Three
 4. Four
- 14-47. Aboard ship, who provides written certification to clearance officials that a customs inspection has been completed?
1. Military customs inspector
 2. Commanding officer
 3. Operations officer
 4. Executive officer

- 14-48. An aircraft arriving from outside the CTUS with less than 3 hours flight time should notify the U.S. port of entry by radio as soon as possible after takeoff.
1. True
 2. False
- 14-49. Personnel must have been onboard a naval vessel continuously for at least how many days before they are considered to have served on extended duty overseas?
1. 30
 2. 60
 3. 90
 4. 120
- 14-50. What form is used to import authorized privately owned firearms into the United States?
1. DD Form 3299
 2. DD Form 1348-2
 3. ATF Form 6
 4. ATF Form 13
- 14-51. What authority is responsible for the training of MCIs at an overseas command?
1. U.S. Customs
 2. Department of State
 3. The overseas command
 4. Department of Agriculture
- 14-52. Who is the point of contact for the issue and destruction of MCI stamps?
1. Commander in Chief, U.S. Atlantic Fleet
 2. Senior Customs Inspector, Norfolk, VA.
 3. Type commander
 4. Squadron commander
- 14-53. What is/are the CMAA's responsibilities in regard to Shore Patrol and Beach Guard?
1. Training
 2. Briefing
 3. Both 1 and 2 above
 4. Selecting personnel for these duties
- 14-54. Which of the following instructions lists other shipboard duties for which the CMAA is responsible?
1. OPNAVINST 5580.1
 2. OPNAVINST 5530.14
 3. OPNAVINST 3120.32
 4. OPNAVINST 3132.20
- 14-55. When should the MA force tour berthing compartments?
1. After taps
 2. After reveille
 3. Both 1 and 2 above
 4. During general quarters
- 14-56. During general visiting, approximately how many visitors should be assigned to each guide?
1. 3 to 5
 2. 6 to 9
 3. 10 to 15
 4. 16 to 20
- 14-57. Who is responsible for the zone inspection procedure?
1. Chief engineer
 2. First lieutenant
 3. Executive officer
 4. Damage control assistant
- 14-58. How long before getting under way should the MA force make an inspection of the ship for stowaways?
1. 20 min
 2. 30 min
 3. 60 min
 4. 90 min

- 14-59. The MA force is responsible for which of the following safety duties?
1. Act as roving inspectors
 2. Assist the safety officer to keep the safety program working
 3. Make internal reports concerning safety violations
 4. All of the above
- 14-60. Civilians are allowed to attend burial at sea services aboard ships, aircraft, and auxiliary craft.
1. True
 2. False
- 14-61. Who directs the pallbearers during the burial at sea service?
1. CO
 2. CMAA
 3. A designated CPO
 4. Command Master Chief
- 14-62. How many flagbearers are used in cases where the remains have been cremated?
1. Six
 2. Two
 3. Eight
 4. Four
- 14-63. When an enlisted person is incapacitated and can no longer care for personal belongings, who must be present during the collection, inventory, and sealing of those belongings?
1. An MA
 2. The division officer
 3. A divisional petty officer
 4. All of the above
- 14-64. Who is responsible for the safekeeping and disposition of an incapacitated enlisted member's personal effects?
1. The division officer
 2. A divisional petty officer
 3. The CMAA
 4. The chaplain
- 14-65. For purposes of inventorying personal belongings, what is the classification of uniform clothing?
1. Class five
 2. Class two
 3. Class three
 4. Class four
- 14-66. Lucky bag items are in what category of personal effects?
1. One
 2. Five
 3. Three
 4. Four
- 14-67. What should be done with objectional material discovered during an inventory of personal effects?
1. Maintained with all other personal effects
 2. Disposed of as directed by the CO
 3. Turned over to the CMAA for safekeeping
 4. Turned over to the division officer
- 14-68. What publication contains detailed information concerning the handling and distribution of personal effects?
1. OPNAVINST 3120.32
 2. NAVSUP Pub 485
 3. OPNAVINST 5530.14
 4. NAVSUP Pub 584

- 14-69. Who is responsible for establishing an evacuation bill aboard ship?
1. Commanding officer
 2. Executive officer
 3. Operations officer
 4. Supply officer
- 14-70. What authority is responsible for conducting a census of civilians evacuated from unfriendly shores?
1. Supply officer
 2. Executive officer
 3. Chief Master-at-Arms
 4. Administrative assistant
- 14-71. What mode of transportation may be used to transport civilians from unfriendly shores or a disaster area to the ship?
1. Small boat
 2. Helicopter
 3. Fixed wing aircraft
 4. All of the above
- 14-72. What evacuees are given preference when being issued life jackets?
1. Children
 2. Women
 3. Both 1 and 2 above
 4. Men
- 14-73. Evacuees should be subsisted on separate messdecks at regular times.
1. True
 2. False
- 14-74. Where should evacuees be assigned during general quarters?
1. On the messdecks
 2. In the assigned berthing space
 3. At a general quarters station
- 14-75. Who is responsible for the Prisoner of War bill?
1. Commanding officer
 2. Executive officer
 3. Administrative assistant
 4. Chief Master-at-Arms

ASSIGNMENT 15

Textbook Assignment: "Shipboard Duties (continued)," and "Investigations," chapters 14 and 15, pages 14-12 through 15-44.

- 15-1. Prisoners of war are not subject to the UCMJ.
1. True
 2. False
- 15-2. What officer is responsible for preparing prisoner muster lists and having prisoners photographed for record purposes?
1. Supply officer
 2. First Lieutenant
 3. Operations officer
 4. Wardroom mess treasurer
- 15-3. Which of the following officers is/are authorized to confiscate all arms, military equipment, and military documents in the possession of the-prisoners?
1. Intelligence officer
 2. Communications officer
 3. Either 1 or 2 above
 4. First Lieutenant
- 15-4. Members of the U.S. Armed Forces and prisoners of war may be confined together.
1. True
 2. False
- 15-5. What instruction provides guidance for handling prisoners of war?
1. OPNAVINST 5580.1
 2. OPNAVINST 5530.14
 3. SECNAVINST 3461.3
 4. SECNAVINST 1643.1
- 15-6. What agency provides direct investigative support as needed both ashore and afloat for the Department of the Navy?
1. The NCIS
 2. The FBI
 3. The CIA
- 15-7. What authority and/or agency should a commanding officer notify when naval personnel are involved in a major crime committed outside a naval installation?
1. The NCIS
 2. The officer with general court-martial jurisdiction
 3. Both 1 and 2 above
 4. The local police agency'
- 15-8. What authority should determine whether or not an investigation should be referred to the Federal Bureau of Investigation?
1. The Chief of Naval Operations
 2. The Naval Criminal Investigative Service
 3. The commanding officer of the installation
 4. The local law enforcement agency
- 15-9. When a crime involves robbery or larceny of government property or funds, who should immediately advise the FBI?
1. The commanding officer
 2. The security officer
 3. The Naval Criminal Investigative Service representative
 4. The Master-at-Arms

- 15-10. A major criminal offense is defined as one punishable under the UCMJ by confinement for a term of more than 1 year.
1. True
 2. False
- 15-11. The Director of the Naval Criminal Investigative Service may decline to investigate a case that may be fruitless and unproductive.
1. True
 2. False
- 15-12. A petty larceny occurred in a naval officer's stateroom and you have been assigned to investigate. Although only petty larceny is involved, you should still inform the NCIS.
1. True
 2. False
- 15-13. A major criminal offense may constitute a violation of both military and civil law and could involve both military and civilian personnel.
1. True
 2. False
- 15-14. A minor criminal offense is defined as one punishable under the UCMJ by confinement of 1 year or less.
1. True
 2. False
- 15-15. Which of the following is a separate operating agency of the Department of Defense and provides for the conduct of personnel security investigations?
1. The NCIS
 2. The FBI
 3. The CIA
 4. The DIS
- 15-16. Which of the following incidents would justify the commanding officer requesting support from NCIS?
1. Sabotage
 2. Espionage
 3. Subversion
 4. Each of the above
- 15-17. Information derived by law enforcement personnel from a person, object, or recorded data is defined as what type of information?
1. Police
 2. Source
 3. Criminal
 4. Operational
- 15-18. In the criminal information process, there are a total of how many steps?
1. Seven
 2. six
 3. Five
 4. Four
- 15-19. What term defines combining information with related information?
1. Collation
 2. Dissemination
 3. Analyzing
 4. Reporting
- 15-20. In what year was the Privacy Act enacted?
1. 1973
 2. 1974
 3. 1975
 4. 1976

- A. Mercenary
- B. Perverse
- C. Egotistical
- D. Eccentric

Figure 15-A

IN ANSWERING QUESTIONS 15-21 THROUGH 15-24, SELECT THE INFORMANT MOTIVE FROM FIGURE 15-A THAT MATCHES THE DESCRIPTION GIVEN AS THE QUESTION.

15-21. One who provides information because of a peculiar quirk in personality.

- 1. A
- 2. B
- 3. C
- 4. D

15-22. One who provides information for the sole purpose of financial gain.

- 1. A
- 2. B
- 3. C
- 4. D

15-23. One who takes pleasure in spreading news to the investigator.

- 1. A
- 2. B
- 3. C
- 4. D

15-24. One who provides information in the hope of gaining some unusual advantage.

- 1. A
- 2. B
- 3. C
- 4. D

15-25. Generally, military courts will treat informant information as which of the following types of information?

- 1. Hearsay
- 2. Credible
- 3. Probable cause
- 4. Expert testimony

15-26. A guiding case demonstrating a conscientious effort to corroborate information is demonstrated in which of the following trials?

- 1. Aguilar v. Texas
- 2. McCray v. Florida
- 3. Spinelli v. United States
- 4. Draper v. United States

15-27. Of the five senses, which two are relied upon the most for description and identification?

- 1. Touch and sight
- 2. Smell and hearing
- 3. Sight and hearing
- 4. Touch and smell

15-28. When observing physical objects for later description, you should follow a pattern proceeding from specific to general.

- 1. True
- 2. False

15-29. What term is used to describe the uncommon characteristics of a person?

- 1. General
- 2. Specific
- 3. Distinctive
- 4. Typical

- 15-30. An important part of a female description is the appearance of the bust. Which of the following terms may be used to describe a woman's bust?
1. Flat
 2. Medium
 3. Heavy
 4. Each of the above
- 15-31. When estimating a person's weight, you should do so in how many pound increments?
1. 5
 2. 2
 3. 10
 4. 20
- 15-32. When the age of a person is estimated, it should be estimated in multiples of how many years?
1. 5
 2. 2
 3. 6
 4. 10
- 15-33. Which of the following characteristics will often constitute the major part of a person's description?
1. Dress
 2. Appearance
 3. Mannerisms
 4. Hair style
- 15-34. It is extremely important that witnesses be interviewed how soon after their observation?
1. As soon as possible
 2. Within 48 hr
 3. Within 72 hr
 4. Within 96 hr
- 15-35. Which of the following are considered the two least reliable senses?
1. Taste and hearing
 2. Smell and touch
 3. Taste and smell
 4. Smell and hearing
- 15-36. Which of the following psychological influences may impair the functioning of a person's senses and result in inaccurate observation?
1. Fear
 2. Prejudice
 3. Anger
 4. All of the above
- 15-37. Which of the following techniques is used to minimize error and eliminate false identification of persons or objects?
1. Lineups
 2. Photographs
 3. Artist sketches
 4. Tape recordings
- 15-38. A lineup should contain a minimum of how many people?
1. 10
 2. 6
 3. 5
 4. 4
- 15-39. When more than one witness is to view a lineup, they should do it at the same time.
1. True
 2. False

- | |
|----------------|
| A. Decoy |
| B. Contact |
| C. Convoy |
| D. Blown |
| E. Subject |
| F. Surveillant |

Figure 15-B

IN ANSWERING QUESTIONS 15-40 THROUGH 15-45. SELECT THE TERM FROM FIGURE 15-B THAT MATCHES THE DESCRIPTION GIVEN AS THE QUESTION.

15-40. The person under observation.

1. C
2. D
3. E
4. F

15-41. The term used to indicate that the identity of a surveillant has been discovered.

1. A
2. C
3. D
4. F

15-42. A person engaged in observing a subject.

1. A
2. B
3. E
4. F

15-43. Any person with whom the subject confers.

1. A
2. B
3. C
4. E

15-44. A person used by the subject to detect a surveillance.

1. B
2. C
3. D
4. E

15-45. A person who attempts to divert the surveillant's attention from the subject.

1. A
2. B
3. C
4. F

15-46. How many general types of surveillance are used by the Master-at-Arms?

1. One
2. Two
3. Three
4. Four

15-47. What term is commonly used to describe mobile surveillance?

1. Dogging
2. Chasing
3. Escorting
4. Shadowing

15-48. What type of surveillance is used when it is not necessary to keep the subject under constant observation?

1. Loose
2. Closed
3. Unrestrained
4. Detached

15-49. What term describes constant observation of a subject?

1. Loose
2. Close
3. Secretive
4. Maintained

15-50. When is the best time to obtain background knowledge of a person in relation to the interview?

1. Before the interview
2. After the interview
3. Throughout the interview
4. During the initial part of the interview

- 15-51. If a suspect you are interviewing doubts your identity or authority, what should you do?
1. Show your credentials
 2. Reassure the suspect verbally
 3. Ignore the doubt and proceed with the interview
 4. Withdraw in favor of another investigator
- 15-52. During an opening statement, should a person who is about to be interrogated be warned of his or her rights? If so, when?
1. Yes; when there is some doubt about the person's involvement in the crime
 2. Yes; when the crime involves narcotics
 3. Yes; when only one investigator is present
 4. No
- 15-53. As an investigator, what attribute determines the success or failure of an interview?
1. Poise
 2. Attitude
 3. Appearance
 4. Intellect
- 15-54. A criminal is surprised and apprehended in the act of committing a crime. When is it best to interrogate that individual?
1. On the spot
 2. When you get the individual in the patrol car
 3. When your supervisor is present
 4. When you get the individual in the interrogation room

- 15-55. When you are interrogating a suspect whose guilt is uncertain or doubtful, you should use what type of approach?
1. Logic
 2. Direct
 3. Indirect
 4. Empathic
- 15-56. The most commonly used interrogation techniques are logic and reasoning and psychological
1. True
 2. False

- A. Cold shoulder
 - B. Logic and reasoning
 - C. The hypothetical story
 - D. Playing one suspect against another

Figure 15-C

IN ANSWERING QUESTIONS 15-57 THROUGH 15-61, SELECT THE SUSPECT INTERROGATION TECHNIQUE FROM FIGURE 15-C THAT MATCHES THE INTERVIEWER'S ACTION GIVEN AS THE QUESTION. RESPONSES MAY BE USED MORE THAN ONCE.

- 15-57. Interviewer confronts suspect with testimony and evidence.
1. A
 2. B
 3. C
 4. D
- 15-58. Interviewer relates a story of a fictitious crime that varies only in minute details from the actual crime.
1. A
 2. B
 3. C
 4. D

- 15-59. Interviewer takes the suspect for a walk past the crime scene without saying anything.
1. A
 2. B
 3. C
 4. D
- 15-60. Interviewer confronts one suspect with known facts that have been allegedly given by another suspect.
1. A
 2. B
 3. C
 4. D
- 15-61. Interviewer points out the futility of denying guilt to the suspect.
1. A
 2. B
 3. C
 4. D
-
- 15-62. Whenever doubt exists as to the elements of proof in a case, the MCM should be reviewed.
1. True
 2. False
- 15-63. What title of the U.S. Code addresses juvenile delinquents?
1. Title 15 Section 5028
 2. Title 16 Section 5029
 3. Title 17 Section 5030
 4. Title 18 Section 5031
- 15-64. Which of the following jurisdictions could police authority exercise on a military reservation?
1. Military
 2. Federal
 3. State
 4. A combination of all
- 15-65. When you are dealing with concurrent jurisdiction, the agency that will become involved is often more a matter of policy than of law.
1. True
 2. False
- 15-66. Does the UCMJ apply to juveniles? If so, to whom?
1. Yes; dependents
 2. Yes; nondependents
 3. No
- 15-67. In which of the following instances would a state crime become an assimilated federal crime?
1. When the crime is committed on a federal reservation
 2. When the crime is not in violation of federal laws or policy
 3. When the federal government exercises exclusive or concurrent jurisdiction
 4. Each of the above
- 15-68. When juveniles commit minor Federal offenses, the case may be heard by what authority?
1. District court
 2. Magistrate
 3. State court
 4. Local court
- 15-69. What will determine the extent to which the Master-at-Arms will become involved in disposing of juvenile offenses?
1. Local policies
 2. Regulations
 3. Both 1 and 2 above
 4. Federal courts

- 15-70. Who will probably be the first to enter a juvenile case and conduct the investigation?
1. FBI
 2. NCIS
 3. Local police
 4. Master-at-Arms
- 15-71. Any questions concerning juvenile suspects at overseas installations require close coordination between security personnel and what other authority?
1. NCIS
 2. Local police
 3. Secretary of the Navy
 4. Judge advocate's office
- 15-72. The Juvenile Justice and Delinquency Prevention Act was passed in what year?
1. 1974
 2. 1975
 3. 1976
 4. 1977
- 15-73. In which, if any, of the following facilities may you detain a juvenile suspect?
1. Confinement facility
 2. Detention cell
 3. Hospital prisoner ward
 4. None of the above
- 15-74. You are taking a juvenile into custody and you intend to prosecute him/her as an adult. From whom should you get written consent prior to taking fingerprints and photographs?
1. The individual's parents
 2. The judge of juvenile court
 3. The NCIS
 4. The local police
- 15-75. When a juvenile is found innocent, what should happen to the individual's record concerning the offense?
1. Held for 1 year
 2. Held for 2 years
 3. Given to the individual's parents
 4. Destroyed

ASSIGNMENT 16

Textbook Assignment: "Investigations (continued)," and "Forensics," chapters 15 and 16, pages 15-44 through 16-15.

- 16-1. The penalty for recentering an installation after ejection provides for a fine of not more than \$500 or imprisonment for not more than how many months?
1. 5
 2. 6
 3. 7
 4. 8
- 16-2. Which of the following offenses involving juveniles on base is considered in the "more serious" category?
1. Larceny
 2. Assault
 3. Extensive vandalism
 4. Each of the above
- 16-3. You are Investigating a youth who becomes uncooperative, rebellious, and insulting. What would be the best procedure for you to take?
1. Try to establish a rapport with this juvenile
 2. Take matters in your own hands and punish this person
 3. Lock the individual in your detention cell until he or she becomes cooperative
 4. Cancel the investigation until the individual calms down
- 16-4. After a crime has been committed by a juvenile, when should the investigator notify the youth's parents?
1. After conducting an investigation
 2. Just after the interview
 3. Immediately after detaining or apprehending
 4. Prior to the interrogation
- 16-5. When you are interrogating a juvenile, what is the best way to create meaningful communications?
1. Use a get-tough attitude
 2. Converse in street language
 3. Be honest and straightforward
- 16-6. When you are interviewing juveniles, it is sometimes a good idea to give a personal experience.
1. True
 2. False
- 16-7. During an interview, only the parents of the juvenile should be made aware of the alternative courses of action available to the commanding officer.
1. True
 2. False
- 16-8. When you conduct an Interrogation, you should avoid placing the youth in a situation where a loss of self-respect is likely to occur.
1. True
 2. False
- 16-9. When it is necessary to contact a youth at school, what school official should you contact first?
1. The teacher
 2. The counselor
 3. The principal

- 16-10. The minimum investigative training for the Master-at-Arms should include education in which of the following areas?
1. Preservation and examination of crime scenes
 2. Provisions of the UCMJ that govern investigations
 3. The scope of the Master-at-Arms investigative responsibility
 4. All of the above
- 16-11. Investigative assignments should be made according to what attribute(s) of the investigator?
1. Aggressiveness
 2. Cheerfulness
 3. Aptitude and individual desires
- 16-12. As the supervisor of an investigative unit you must obtain answers to which of the following planning considerations?
1. What should be done and why
 2. When, where, and how should the task be done
 3. Who should do the task and the estimated time required
 4. All of the above
- 16-13. When assigning cases to personnel, what will probably be your most difficult decision?
1. Assigning an equal number of cases to all personnel
 2. Assigning simple tasks to less experienced personnel
 3. Assigning surveillance tasks to personnel in top physical condition
 4. Assigning tasks that fit the person without over-burdening the more experienced personnel
- 16-14. What is the most positive way to identify a person?
1. Pictures
 2. Personal identification
 3. Fingerprints
 4. Background information
- 16-15. When, if ever, do the friction ridges on a person's hands change during his/her lifetime?
1. Just after birth
 2. When the individual gains maturity
 3. At the age of 65
 4. Never
- 16-16. Which of the following terms is NOT used in classifying or describing fingerprints?
1. Bifurcation
 2. Core
 3. Divergence
 4. Tangent
- 16-17. What term identifies fingerprints that spread apart at two ridges that have been running nearly parallel?
1. Deformed fingers
 2. Pattern area
 3. Divergence
 4. Focal points

- | |
|--|
| <ul style="list-style-type: none"> A. Palmer B. Shoulders C. Focal points D. Bifurcation |
|--|

Figure 16-A

IN ANSWERING QUESTIONS 16-18 THROUGH 16-21, SELECT THE FINGERPRINT CLASSIFICATION TERM FROM FIGURE 16-A THAT MATCHES THE DESCRIPTION GIVEN AS THE QUESTION.

- 16-18. The delta and core located within the pattern area of loops and whorls.
1. A
 2. B
 3. C
 4. D
- 16-19. The forking or dividing of one ridge line into two or more branches.
1. A
 2. B
 3. C
 4. D
- 16-20. The points at which the recurring ridge of a loop-type pattern definitely turns inward or curves.
1. A
 2. B
 3. C
 4. D
- 16-21. Pertaining to palm impressions of the hand.
1. A
 2. B
 3. C
 4. D
- 16-22. A point is a ridge characteristic formed by bifurcation, ridge ending, or dot.
1. True
 2. False
- 16-23. The taking of good, clean, fingerprints is not difficult.
1. True
 2. False
- 16-24. The two innermost ridges that start parallel, diverge, and tend to surround the entire pattern area are called type lines.
1. True
 2. False
- 16-25. The term plantar pertains to sole impressions of the foot.
1. True
 2. False
- 16-26. Prior to fingerprinting a subject, what is the first thing you should have the subject do?
1. Wash his hands
 2. Sign the fingerprint card
 3. Place his fingers on the ink plate
- 16-27. A good fingerprint impression should be what color?
1. Gray
 2. Black
 3. Brown
 4. Dark gray
- 16-28. What is the purpose for taking plain fingerprint impressions?
1. To reduce smudging
 2. To reduce deformity
 3. They are easier to take
 4. To verify rolled impressions

- 16-29. When a photographic fingerprint impression is being taken, the photographic paper should be placed in a fixing bath for approximately how many seconds?
1. 10
 2. 20
 3. 30
 4. 40
- 16-30. What is the greatest problem with making palm prints?
1. Palm prints are basically the same for everyone
 2. Palm prints require too much space on the page
 3. Palm prints are frequently smudged
 4. Palm prints are difficult to obtain due to the hollow in the palm
- 16-31. What is the best method to record palm prints?
1. Use very flexible paper with white powder
 2. Have the individual press down hard with the palm
 3. Use a tubular object wrapped with printing paper to roll the prints
 4. Have the individual use heavy, black printer's ink
- 16-32. Which of the following will result in poor fingerprint impressions?
1. Failure to clean the inking apparatus
 2. Failure to clean the individual's fingers
 3. Failure to roll the fingers properly
 4. All of the above
- 16-33. Latent prints fall under a total of how many general classifications?
1. One
 2. Two
 3. Three
 4. Four
- 16-34. When a latent print is found at a crime scene, which of the following actions should be taken first?
1. Lift it with masking tape
 2. Lift it with robber tape
 3. Measure out the pattern
 4. Photograph it
- 16-35. What fingerprint powder has the advantage of showing up on either a dark or light background?
1. Dragon's blood
 2. Blue
 3. Gray
 4. White
- 16-36. Which of the following items should NOT be used to apply fingerprint powder?
1. Fiberglass
 2. Feather brush
 3. Camel's hair brush
 4. Tissue paper
- 16-37. When using a short-wave ultraviolet light, the investigator should wear which of the following apparel?
1. Rubber gloves only
 2. Goggles only
 3. Rubber gloves and goggles
 4. Goggles and protective clothing

16-38. What are the most common materials used for lifting latent fingerprints?

1. Masking tape and rubber lifters
2. Adhesive and transparent tapes
3. Clear tape and rubber lifters
4. Rubber lifters and transparent lifting tapes

16-39. What type of tape is best for lifting prints located on curved or uneven surfaces?

1. Scotch
2. Masking
3. Rubber
4. Shipping

16-40. Fingerprint patterns have a total of how many basic classification designations?

1. One
2. Two
3. Three
4. Four

16-41. What fingerprint pattern has two or more deltas?

1. Accidental whorl
2. Ulnar
3. Radial
4. Arches

16-42. Patterns that flow toward the thumbs are known as what type of loops?

1. Accidental whorl
2. Radial
3. Ulnar
4. Arches

16-43. What fingerprint loops flowing in the direction of the-little fingers?

1. Radial
2. Tented arches
3. Plain arches
4. Ulnar

16-44. What type of pattern has the ridges forming concentric circles or spirals?

1. Whorls
2. Lops
3. Tented arches
4. Arches

16-45. A loop must have a total of how many essential characteristics?

1. One
2. Two
3. Three
4. Four

- | |
|---|
| <ol style="list-style-type: none">A. ObjectB. MoldC. CastD. Impression |
|---|

Figure 16-B

IN ANSWERING QUESTIONS 16-46 THROUGH 16-49, SELECT THE TERM FROM FIGURE 16-B THAT MATCHES THE DESCRIPTION GIVEN AS THE QUESTION.

16-46. A positive impression made from a mold.

1. A
2. B
3. C
4. D

16-47. Anything making an impression.

1. A
2. B
3. C
4. D

16-48. Any indentation from which a cast is made.

1. A
2. B
3. C
4. D

- 16-49. A negative impression.
1. A
 2. B
 3. C
 4. D
-
- 16-50. What should be the first thing done to an impression found at a crime scene?
1. Photographed
 2. Protected
 3. Sketched
 4. Casted
- 16-51. Spraying an impression with which of the following material will help to strengthen the impression to support the weight of the casting material?
1. Shellac
 2. Plastic spray
 3. Hair net spray
 4. Each of the above
- 16-52. Usually how many coats of a spray material is sufficient to help support the weight of the casting material in sandy soils?
1. 1 to 2
 2. 3 to 10
 3. 12 to 15
 4. 16 to 20
- 16-53. When plastic spray is used to help support the weight of the casting material, a thin mist of which of the following materials should be allowed to settle on the print?
1. Water
 2. Light oil
 3. Vinegar
 4. Shellac
- 16-54. Reinforcement material should be added to the print after how much plaster has been laid?
1. 1/8 to 1/4 in.
 2. 3/16 to 5/16 in.
 3. 1/2 to 3/4 in.
 4. 15/16 to 1 1/2 in.
- 16-55. When added with the water used in making plaster, which of the following materials will hasten the setting?
1. Sugar
 2. Borax
 3. Salt
- 16-56. When added with the water used in making plaster, which of the following materials will retard the setting 15 to 30 minutes?
1. Sugar
 2. Borax
 3. Salt
- 16-57. It usually takes plaster how many minutes to harden after preparation?
1. 10 to 12
 2. 15 to 18
 3. 20 to 30
 4. 45 to 60
- 16-58. When casting under water and using plaster, how many parts of salt should be added to 10 to 12 parts of plaster to hasten the setting time?
1. 1 t 0 2
 2. 2 t 0 4
 3. 3 t 0 4
 4. 5 t 0 7

16-59. Which of the following casting materials is lighter than plaster of Paris, much more economical, and is highly recommended for use?

1. EPOXY
2. Dental stone
3. Silicone rubber
4. Posmoulage

16-60. Which of the following casting materials may be used to obtain fingerprint impressions found in putty and caulking?

1. EPOXY
2. Dental stone
3. Silicone rubber
4. Posmoulage

ASSIGNMENT 17

Textbook Assignment: "Forensics (continued)," chapter 16, pages 16-15 through 16-40,

17-1. Which of the following materials would be excellent to make a cast of extremely faint hammer blows on a safe?

1. Posmoulage
2. Epoxy casting
3. Silicone rubber
4. Dental stone

17-2. What is the approximate circumference of a tire, in feet?

1. 1 to 3
2. 5 to 8
3. 10 to 12
4. 13 to 15

17-3. When using a hollow cast with melted moulage, how many minutes should you let it stand before pouring out the excess moulage?

1. 1 to 1 1/2
2. 2 to 3
3. 5 to 6
4. 10 to 15

17-4. When a laboratory examines cast and mold evidence, class and individual characteristics are considered.

1. True
2. False

17-5. Which of the following types of markers may be used to mark glass fragments?

1. Grease pencil
2. Diamond point pencil
3. Carborundum pencil
4. All of the above

- | |
|---|
| <ol style="list-style-type: none">A. DensityB. Fluorescencec. Refractive indexD. Spectrographic analysis |
|---|

Figure 17-A

IN ANSWERING QUESTIONS 17-6 THROUGH 17-9, SELECT THE EXAMINATION TERM FROM FIGURE 17-A THAT MATCHES THE DESCRIPTION GIVEN AS THE QUESTION.

17-6. Refers to the change of direction of a ray of light passing through a medium.

1. A
2. B
3. C
4. D

17-7. Based on the fact that mineral constituents impart a distinctive reaction when this technique is used.

1. A
2. B
3. C
4. D

17-8. This technique is based on comparing the characteristics of known and unknown pieces of glass.

1. A
2. B
3. C
4. D

- 17-9. Has the greatest value in demonstrating major differences between two samples.
1. A
 2. B
 3. C
 4. D

- | |
|--|
| <ol style="list-style-type: none">A. Tool markB. Friction markC. Combination markD. Negative impression |
|--|

Figure 17-B

IN ANSWERING QUESTIONS 17-10 THROUGH 17-15, SELECT THE TERM FROM FIGURE 17-B THAT MATCHES THE DESCRIPTION GIVEN AS THE QUESTION. RESPONSES MAY BE USED MORE THAN ONCE.

- 17-10. Made when a tool is pressed against or into a receiving surface.
1. A
 2. B
 3. C
 4. D
- 17-11. Made when a crowbar is forcefully inserted into a space between a door and the door facing.
1. A
 2. B
 3. C
 4. D
- 17-12. Made when a tool cuts into or slides across a surface.
1. A
 2. B
 3. C
 4. D
- 17-13. Usually made when a crowbar is used to pry open a door or window.
1. A
 2. B
 3. C
 4. D
- 17-14. An impression, cut, scratch, or abrasion made when a tool is brought into contact with an object.
1. A
 2. B
 3. C
 4. D
- 17-15. This type of mark may be made by a bolt cutter.
1. A
 2. B
 3. C
 4. D
-
- 17-16. Tool mark evidence may be used for which of the following reasons?
1. To link a person who uses a given tool with the crime scene
 2. To establish a connection between similar evidence discovered in a series of crimes
 3. To compare a tool mark from a crime scene with a tool mark found on the property of a suspect
 4. All of the above
- 17-17. When processing a tool mark as evidence, how many different courses of actions are available to the investigator?
1. Seven
 2. Five
 3. Three
 4. Nine

- 17-18. A casting can be just as good or better than the original impression.
1. True
 2. False
- 17-19. An area containing a tool mark that is removed as evidence should be marked with all except which of the following information?
1. Case number
 2. Command's name
 3. Investigator's initials
 4. Date and time of removal
- 17-20. Wire obtained for laboratory examination should not be cut with the suspect tool.
1. True
 2. False
- 17-21. Serial numbers on manufactured objects are made up of which of the following?
1. Individual letters
 2. Combination of numbers
 3. Combination of numbers, letters or symbols
 4. All of the above
- 17-22. Serial numbers are usually attached to objects in all but which of the following ways?
1. Engraved
 2. Permanent ink
 3. Molded
 4. Etched
- 17-23. On a normal person, blood usually begins to clot after how many minutes?
1. 1 to 2
 2. 2 to 3
 3. 3 to 5
 4. 6 to 8
- 17-24. What color is blood after it has completely dried?
1. Red
 2. Black
 3. Reddish-brown
 4. Reddish-black
- 17-25. When a drop of blood falls from 6 to 12 inches, the bloodstains appear as a circular disk on a smooth surface.
1. True
 2. False
- 17-26. When a drop of blood falls from 12 to 60 inches, the bloodstains appear jagged.
1. True
 2. False
- 17-27. When a drop of blood falls from 2 to 3 yards, it may splash upon impact and form many small bloodstains.
1. True
 2. False
- 17-28. Blood usually clots in approximately how many minutes?
1. 1 to 3
 2. 4 to 6
 3. 10 to 20
 4. 25 to 30
- 17-29. Before sending a bloodstained article to the lab for examination it should be thoroughly dried. How should the drying process be completed?
1. Place the article in a dryer
 2. Place the article under heat lamps
 3. Place the article where an electric fan can blow across
 4. Place the article where it can dry naturally

17-30. What fraction of an ounce of blood is required for laboratory examination?

1. 1/16
2. 1/6
3. 1/4
4. 1/2

17-31. How many tubes of blood should be submitted to the lab for examination?

1. One
2. Two
3. Three
4. Four

17-32. Human blood is classified into a total of how many blood groups?

1. six
2. Five
3. Three
4. Four

17-33. In the continental United States, what is the approximate percentage of people who belong to blood group AB?

1. 7%
2. 2%
3. 3%
4. 5%

17-34. In the continental United States, what is the approximate percentage of people who belong to blood group O?

1. 75%
2. 63%
3. 51%
4. 43%

17-35. Grouping dried blood stains is considerably more difficult than grouping liquid blood.

1. True
2. False

17-36. When human blood is examined in the laboratory, the preferred test is the precipitin test.

1. True
2. False

17-37. For blood group testing, what size bloodstain is generally sufficient for a conclusive determination?

1. 1/16 x 1/8 in.
2. 1/6 x 1/8 in.
3. 1/2 x 1/4 in.
4. 3/4 x 7/8 in.

17-38. Approximately what percentage of the population are secretors?

1. 25%
2. 35%
3. 65%
4. 80%

- | |
|---|
| <ol style="list-style-type: none">A. cortexB. Cuticlec. MedullaD. Cuticular scales |
|---|

Figure 17-C

IN ANSWERING QUESTIONS 17-39 THROUGH 17-44, SELECT THE TERM FROM FIGURE 17-C THAT HATCHES THE DESCRIPTION GIVEN AS THE QUESTION. RESPONSES MAY BE USED MORE THAN ONCE.

17-39. A continuous dark line of varying width running up the center.

1. A
2. B
3. C
4. D

17-40. The outer surface of the hair.

1. A
2. B
3. C
4. D

- 17-41. Similar to overlapping shingles on a roof.
1. A
 2. B
 3. C
 4. D
- 17-42. The inner portion of the hair.
1. A
 2. B
 3. C
 4. D
- 17-43. The core portion of the hair shaft.
1. A
 2. B
 3. C
 4. D
- 17-44. Contains the pigmentation of the hair.
1. A
 2. B
 3. C
 4. D
-
- 17-45. What is usually the first thing a laboratory determines about a hair sample?
1. If it is from a male or female
 2. If it is human or animal
 3. The race of the person
 4. The part of the body the hair is from
- 17-46. In the case of human hairs the laboratory determinations may include which of the following?
1. How the hair was removed
 2. How the hair was treated
 3. Blood grouping
 4. All of the above
- 17-47. Contact between two pieces of fabric seldom can be made without an interchange of fiber material.
1. The
 2. False
- 17-48. When known samples from a victim or suspect are collected, what minimum quantity of hair or fabric strands should be collected?
1. 5
 2. 12
 3. 20
 4. 35
- 17-49. When you secure soil for comparison samples, about how much soil should you collect?
1. 1 teaspoon
 2. 2 tablespoons
 3. 5 large scoops
 4. 1 quart
- 17-50. When a soil sample is taken, it is seldom necessary to dig deeper than how many inches?
1. $1/8$ to $1/4$
 2. $1/8$ to $3/16$
 3. $1/2$ to $3/4$
 4. 1 to 2

- | |
|--|
| <ul style="list-style-type: none"> A. Spectrograph B. Infrared light C. Ultraviolet light D. Spectrophotometer E. Gas-liquid chromatography |
|--|

Figure 17-D

IN ANSWERING QUESTIONS 17-51 THROUGH 17-60, SELECT THE LABORATORY TECHNIQUE FROM FIGURE 17-D THAT MATCHES THE DESCRIPTION GIVEN AS THE QUESTION. RESPONSES MAY BE USED MORE THAN ONCE.

- 17-51. Permits qualitative and quantitative analysis of a substance.
- 1. B
 - 2. C
 - 3. D
 - 4. E
- 17-52. Material to be analyzed is injected.
- 1. A
 - 2. B
 - 3. D
 - 4. E
- 17-53. Has no fluorescent effect that can be seen with the unaided eye.
- 1. A
 - 2. B
 - 3. C
 - 4. D
- 17-54. The light emission phenomenon resulting is one of fluorescence.
- 1. B
 - 2. C
 - 3. D
 - 4. E
- 17-55. Minute quantities of evidentiary material are often analyzed.
- 1. A
 - 2. B
 - 3. D
 - 4. E
- 17-56. A mixture of several substances may be analyzed.
- 1. A
 - 2. B
 - 3. D
 - 4. E
- 17-57. Produces a graph showing the basic constituents and trace elements.
- 1. A
 - 2. B
 - 3. D
 - 4. E
- 17-58. Uses a slightly shorter wavelength than normal visible light.
- 1. A
 - 2. B
 - 3. C
 - 4. D
- 17-59. The application of this instrument lies primarily in its identification and analysis of substances.
- 1. A
 - 2. C
 - 3. D
 - 4. E
- 17-60. Uses a slightly longer wavelength than normal visible light.
- 1. B
 - 2. C
 - 3. D
 - 4. E
-

17-61. Conditions under which polygraph examinations may be conducted are set forth in which of the following manuals?

1. SECNAVINST 3120.32
2. SECNAVINST 5520.4
3. OPNAVINST 5580.1
4. OPNAVINST 5530.14

17-62. Only DOD-certified examiners or intern examiners under direct supervision of a certified examiner are authorized to conduct polygraph examinations.

1. True
2. False

ASSIGNMENT 18

Textbook Assignment: "Forensics (continued)," and "Evidence Custody," chapters 16 and 17, pages 16-41 through 17-8.

- 18-1. From whom should you obtain authorization to conduct a polygraph examination?
1. Local NCIS agent
 2. Director of the NCIS
 3. Under Secretary of the
 4. Senior officer present

- | |
|--|
| <ol style="list-style-type: none">A. No opinionB. No deceptionC. InconclusiveD. Deception indicated |
|--|

Figure 18-A

- 18-2. The polygraph examiner is prohibited from conducting examination when, in the examiner's opinion, the person fits which of the following descriptions?

1. Physically fatigued
2. Known to have a mental disorder
3. Below the age of reason
4. Each of the above

- 18-3. Upon completion of the polygraph examination, the examiner may come to one of how many conclusions?

1. Seven
2. Six
3. Three
4. Four

IN ANSWERING QUESTIONS 18-4 THROUGH 18-10, SELECT THE CONCLUSION FROM FIGURE 18-A THAT MATCHES THE DESCRIPTION GIVEN AS THE QUESTION. RESPONSES MAY BE USED MORE THAN ONCE.

- 18-4. The subject is informed that the examination has been completed and the charts will be subjected to a detailed analysis.

1. A
2. B
3. C
4. D

- 18-5. The examinee is deliberately distorting the charts.

1. A
2. B
3. C
4. D

- 18-6. The examiner interrogates the examinee and attempts to determine the causes of specific responses.

1. A
2. B
3. C
4. D

- 18-7. The examinee has a cold and rapport is not established.
1. A
 2. B
 3. C
 4. D
- 18-8. The examinee seems to suffer from a permanent psychological disorder.
1. A
 2. B
 3. C
 4. D
- 18-9. After the subject leaves the room the examiner carefully evaluates the charts and confers with the investigator if doubts exist.
1. A
 2. B
 3. C
 4. D
- 18-10. A subsequent examination may be made by the original examiner without obtaining additional approval.
1. A
 2. B
 3. C
 4. D
-
- 18-11. What action should the Master-at-Arms take at a crime scene if the offense is to be investigated by NCIS?
1. Question witnesses
 2. Collect all evidence
 3. Present the findings
 4. Protect the crime scene
- 18-12. When evidence is searched for in large outdoor areas. it is advisable to divide the area into strips approximately how wide?
1. 10 ft
 2. 2 ft
 3. 7 ft
 4. 4 ft
- 18-13. When you search indoors or outdoors, the search area may be divided into what type of areas?
1. Zones only
 2. Sectors only
 3. Zones and sectors
 4. Regions
- 18-14. Evidence may not be released to any person other than the evidence custodian without supervisor approval.
1. True
 2. False
- 18-15. Properly prepared sketches are useful for which of the following reasons?
1. Preparing reports
 2. Questioning witnesses
 3. Refreshing your memory
 4. Each of the above
- 18-16. A sketch provides the best means of portraying distances between objects at the scene.
1. True
 2. False
- 18-17. What method of sketching should be used for indoor sketches?
1. Outline
 2. Vertical
 3. Horizontal
 4. Triangulation

18-18. Of the following considerations, which one is most important in crime scene photography?

1. Time
2. Evidence flags
3. Extraneous objects
4. Maintaining perspective

- A. Filters
 - B. Film speed
 - c. Lens speed
 - D. Shutter speed
 - E. Exposure meter

Figure 18-B

IN ANSWERING QUESTIONS 18-19 THROUGH 18-24, SELECT THE PHOTOGRAPHIC TERM FROM FIGURE 18-B THAT MATCHES THE DESCRIPTION GIVEN AS THE QUESTION. RESPONSES MAY BE USED MORE THAN ONCE.

18-19. Controls the amount of time the light is allowed to reach the film.

1. B
2. C
3. D
4. E

18-20. Controls the amount of light transmitted to the film.

1. A
2. B
3. C
4. D

18-21. Identifies the sensitivity of the film to light.

1. B
2. C
3. D
4. E

18-22. Controls the amount of light entering the lens.

1. A
2. B
3. C
4. E

18-23. Determines the light value of a scene or object.

1. A
2. B
3. D
4. E

18-24. Classified as slow, medium, or fast.

1. B
2. C
3. D
4. E

18-25. What are the two general categories of color film?

1. Ektachrome and anscochrome
2. Ektacolor and ansco color
3. Negative and positive
4. Prints and slides

18-26. Physical evidence is one of the most valuable assets in pursuing an investigation to a successful conclusion.

1. True
2. False

18-27. Which of the following techniques is used to achieve the maximum benefit from physical evidence?

1. Handling
2. Collecting
3. Preserving
4. Each of the above

- 18-28. Physical evidence is divided into a total of how many general categories?
1. One
 2. Two
 3. Three
 4. Four
- 18-29. A wall, floor, or telephone pole would be what category of evidence?
1. Secure
 2. Temporary
 3. Both 1 and 2 above
 4. Fixed
- 18-30. Which of the following individuals must be able to authenticate a piece of evidence at a later date?
1. Investigator
 2. Security officer
 3. Person who first receives it
 4. All of the above
- 18-31. Correct identification of evidence occurs when the member taking custody of the evidence promptly marks and tags the item.
1. True
 2. False
- 18-32. Evidence should be inscribed with which of the following two items?
1. Name of collector and date and time
 2. Initials of collector and military date and time
 3. Case control number and storage location
 4. Name of command and estimated value
- 18-33. Which of the following should you NOT do when you mark evidence?
1. Destroy latent characteristics
 2. Reduce the object's function
 3. Devalue the object
 4. Each of the above
- 18-34. When an item of evidence cannot be marked without destroying evidentiary characteristics, which of the following actions should be taken?
1. Place the item in a sealed container and mark it for identification
 2. Identify the item with an evidence tag only
 3. Photograph the item only
- 18-35. The chain of custody begins when an item of evidence is collected by the security force member.
1. True
 2. False
- 18-36. What term identifies a written, chronological record of evidence transactions?
1. Good record keeping
 2. Evidence tagging
 3. Investigative notes
 4. Chain of custody
- 18-37. Each person listed on the chain of custody is responsible for each item of evidence while under the individual's control.
1. True
 2. False
- 18-38. Who assumes the responsibility of evidence when it is NOT in use by a competent authority?
1. Owner
 2. Security officer
 3. Evidence custodian
 4. Investigations supervisor
- 18-39. What individual appoints the evidence custodian and the alternate?
1. Commanding officer
 2. Executive officer
 3. Security officer
 4. Chief Master-at-Arms

- 18-40. What OPNAV Form is used as the evidence/property custody receipt?
1. 5527/9
 2. 5527/15
 3. 5527/17
 4. 5527/22
- 18-41. What method should be used to enter items on the evidence custody document?
1. Typed only
 2. Printed in Ink only
 3. Typed or printed in ink
 4. Pencil
- 18-42. What should be done with the second copy of the evidence/property custody document?
1. Kept with the evidence
 2. Returned to the owner
 3. Attached to the incident compliant report
 4. Sent to the local NCIS office
- 18-43. The evidence log and all supporting documentation should be retained for a minimum of how many years?
1. 10
 2. 2
 3. 3
 4. 5
- 18-44. Approved evidence containers and strong room requirements are outlined in which of the following Instructions?
1. OPNAVINST 5580.1
 2. OPNAVINST 5530.14
 3. OPNAVINST 5522.2
 4. OPNAVINST 5510.1
- 18-45. The combinations of all evidence containers must be changed in which of the following situations?
1. Annually
 2. When a new security officer is appointed
 3. When a suspected breach of evidence security occurs
 4. Each of the above
- 18-46. A complete inventory of evidence and reconciliation of documents must be accomplished at least how often?
1. Annually
 2. Semiannually
 3. Quarterly
 4. Monthly
- 18-47. Which of the following individuals should NOT be involved in an evidence inventory?
1. Security officer
 2. An interested third party
 3. Evidence custodian
 4. Alternate evidence custodian
- 18-48. Of the following methods of evidence transmittal, which one is NOT authorized?
1. Registered mail
 2. First-class mail
 3. Second-class mail
 4. Freight or hand-carry
- 18-49. Which of the following materials may NOT be transmitted through the U.S. mail?
1. Gas
 2. Chemical
 3. Ammunition
 4. Each of the above
- 18-50. What is the final link in the evidence custody chain?
1. Disposition
 2. Transfer
 3. Storage
 4. Control

ASSIGNMENT 19

Textbook Assignment: "Administration," chapter 18, pages 18-1 through 18-16.

19-1. One individual can control and effectively supervise which of the following work groups?

1. Department
2. Division
3. Section
4. Watch

- A. Position
 - B. Functional
 - C. Structural
 - D. Combination

Figure 19-A

IN ANSWERING QUESTIONS 19-2 THROUGH 19-6, SELECT THE TYPE OF CHART FROM FIGURE 19-A THAT MATCHES THE DESCRIPTION GIVEN AS THE QUESTION. RESPONSES MAY BE USED MORE THAN ONCE.

19-2. Shows the responsibilities of components in the organization.

1. A
2. B
3. C
4. D

19-3. Outlines the basic relationships of an organization in a simple manner.

1. A
2. B
3. C
4. D

19-4. Uses information from structural, functional, and position charts.

1. A
2. B
3. C
4. D

19-5. Shows names, positions, and titles of personnel assigned.

1. A
2. B
3. C
4. D

19-6. The best chart to use for simple organizations.

1. A
2. B
3. C
4. D

19-7. Which of the following terms identifies a course of action devised for the accomplishment of a specific objective according to a time schedule?

1. Task
2. Policy
3. Program
4. Procedure

19-8. A plan without specific orders or directives is based on which of the following elements?

1. Recommendations
2. Case history
3. Assumptions
4. Guess work

19-9. When the required Master-at-Arms manpower strength is being determined, what factors should be considered?

1. Geographic aspects of area of operation
2. Capabilities of organic units
3. Confinement facility requirements
4. All of the above

19-10. Consolidating the various functions of a Master-at-Arms facility will help reduce which of the following requirements?

1. Work loads
2. Work plans
3. Roving patrols
4. Administrative overhead

19-11. What term identifies a common-sense, systematic method of analyzing problems, developing solutions, and installing improvements?

1. Work simplification
2. Work smarter
3. Teamwork
4. Synergy

19-12. Work methods may be improved by analyzing which-of the-following factors?

1. Work distribution and volume
2. Steps in a sequence of operations
3. Physical motions and space arrangements
4. All of the above

- | |
|--|
| <p>A. Crime repression</p> <p>B. Crime risk management</p> <p>C. Crime prevention campaign</p> <p>D. Crime prevention inspection</p> |
|--|

Figure 19-B

IN ANSWERING QUESTIONS 19-13 THROUGH 19-17, SELECT THE CRIME PREVENTION TERM FROM FIGURE 19-B THAT MATCHES THE DESCRIPTION GIVEN AS THE QUESTION. RESPONSES MAY BE USED MORE THAN ONCE.

19-13. A systematic approach to reduce crime risks.

1. A
2. B
3. C
4. D

19-14. The observing of persons and places considered crime producing.

1. A
2. B
3. C
4. D

19-15. A program designed to deal with the control or prevention of specific types of crime based on a pattern of occurrence.

1. A
2. B
3. C
4. D

19-16. To discourage naval personnel from participating in activities conducive to crime.

1. A
2. B
3. C
4. D

19-17. An on-site evaluation of the crime prevention program of a unit, section, office, or other facility.

1. A
2. B
3. C
4. D

19-18. What are the two factors present in the commission of any criminal act?

1. Desire and opportunity
2. Ambition and passion
3. Intent and objective
4. Design and purpose

- 19-19. What term identifies a direct crime patrol method that applies to before-the-fact efforts?
1. Crime prevention
 2. Crime repression
 3. Crime risk management
 4. Crime campaign
- 19-20. Which of the following is a method of crime repression?
1. Patrolling
 2. Crime prevention survey
 3. Crime inspection
 4. Each of the above
- 19-21. Crime prevention is designed to reduce what human element?
1. Complexes
 2. Inhibitions
 3. Desire
 4. Guilt
- 19-22. What type of survey should be initiated when the rate of offenses and incidents increases?
1. Crime prevention
 2. Crime repression
 3. Crime threat
 4. Crime risk
- 19-23. When planning a crime prevention survey, civilian establishments visited by military personnel should receive primary emphasis.
1. True
 2. False
- 19-24. Facts obtained from a crime prevention survey can reveal that a civilian establishment should be placed off limits.
1. True
 2. False
- 19-25. A survey of civilian establishments can result in a recommendation for reducing, establishing, or eliminating patrols.
1. True
 2. False
- 19-26. The same investigative techniques used to investigate crime should be used to conduct crime prevention surveys.
1. True
 2. False
- 19-27. What term identifies the science of the systematic collection, classification, tabulation, and interpretation of numerical facts?
1. statistics
 2. Abstracts
 3. Findings
 4. Results
- 19-28. Only the Master-at-Arms force is concerned with crime rates and types of crimes; therefore, these figures are not available to the commanding officer.
1. True
 2. False
- 19-29. When you use statistics in a crime prevention program, what is the first corrective step to take?
1. Make corrective recommendations to CNO
 2. Turn the facts over to civilian authorities for action
 3. Isolate specific aspects of the problem
 4. File the facts until definite patterns are established

19-30. What statistical calculation(s) is/are helpful to the MA in determining where the problem areas are?

1. Rate
2. Percentage
3. Both 1 and 2 above
4. Frequency

19-31. A percentage is calculated on the basis of what numerical value?

1. 100
2. 200
3. 300
4. 400

19-32. What would the rate of AWOLS per 1,000 personnel be if a district with 25,000 personnel had 750 AWOLS in a year?

1. 10
2. 20
3. 30
4. 40

19-33. The MA will find most of the statistical data required from which of the following sources?

1. Records and reports
2. Newspapers and magazines
3. Anecdotes and interviews
4. Radio and television

- A. Vertical bar
 - B. spot map
 - C. Pie chart
 - D. Curve chart

Figure 19-C

IN ANSWERING QUESTIONS 19-34 THROUGH 19-37, SELECT THE GRAPH FROM FIGURE 19-C THAT MATCHES THE DESCRIPTION GIVEN AS THE QUESTION.

19-34. Compares various components with each other and the whole.

1. A
2. B
3. C
4. D

19-35. Used to depict numerical values of a given item over a period of time.

1. A
2. B
3. C
4. D

19-36. Used when data covers a long period of time.

1. A
2. B
3. C
4. D

19-37. Used to depict locations of incidents or accidents.

1. A
 2. B
 3. c
 4. D
-

19-38. The primary purpose of a frequency distribution table is to depict which of the following data?

1. Ratio of convictions obtained
2. Number, time, or place of violations by category
3. Units of measure only
4. Number of mobile patrols employed

- A. Consent search
 - B. Voluntary statement form
 - C. Civilian suspect's acknowledgment of rights form
 - D. Record of authorization for search

Figure 19-D

IN ANSWERING QUESTIONS 19-39 THROUGH 19-42, SELECT THE FORM FROM FIGURE 19-D THAT MATCHES THE DESCRIPTION GIVEN AS THE QUESTION.

19-39. Used prior to questioning a civilian suspect.

1. A
2. B
3. C
4. D

19-40. Used when taking a written statement from a witness.

1. A
2. B
3. C
4. D

19-41. Submitted to the commanding officer to authorize a search.

1. A
2. B
3. C
4. D

19-42. Used to conduct a search of a person who has given voluntary consent to be searched.

1. A
2. B
3. C
4. D

19-43. How should changes be made to publications and directives?

1. Inserting new pages
2. Removing obsolete pages
3. Writing changes with pen
4. Each of the above

19-44. Where can information be found concerning the organizational structure of the Navy?

1. Uniform Regulations
2. SECNAV instructions
3. Navy Regulations
4. CNO notices

19-45. What authority sets forth the basic policies, standards, and procedures for the operation of Navy confinement facilities?

1. Chief of Naval Operations
2. Chief of Naval Personnel
3. Secretary of the Navy
4. Congress

19-46. What is the subject of Part III of the Manual for Courts-Martial?

1. Courts-martial
2. Rules of evidence
3. Punitive articles
4. Nonjudicial punishment

19-47. You will be expected to identify the various publications at your command by title and appearance and have a general idea of the contents of each.

1. True
2. False

19-48. Which of the following publications contains information regarding delivery of service members?

1. MCM
2. JAGMAN
3. SORM
4. UCMJ

19-49. Who prepares the United States Navy Uniform Regulations?

1. Secretary of the Navy
2. Chief of Naval Personnel
3. Chief of Naval Operations
4. Chief of Supply Corps

19-50. Which OPNAV instruction pertains to U.S. Navy physical security and loss prevention?

1. 5510.45
2. 5510.45
3. 5530.14
4. 5531.15

19-51. Information pertaining to honors and ceremonies can be found in what publication(s)?

1. NTP 13
2. U.S. Navy Regulations
3. Both 1 and 2 above
4. The law enforcement manual

19-52. What authority distributes the Navy Information and Personnel Security Program Regulation?

1. Chief of Naval Personnel
2. Chief of Naval Operations
3. Under Secretary of the Navy